



US00D842159S

(12) **United States Design Patent** (10) **Patent No.:** **US D842,159 S**
Qin (45) **Date of Patent:** **** Mar. 5, 2019**

(54) **NECKLACE**
(71) Applicant: **ACE LIGHT & ELECTRONIC TECH (NINGBO) CO., LTD.**, Ningbo, Zhejiang Province (CN)
(72) Inventor: **Yanbei Qin**, Ningbo (CN)
(73) Assignee: **ACE LIGHT & ELECTRONIC TECH (NINGBO) CO., LTD.**, Ningbo, Zhejiang Province (CN)
(**) Term: **15 Years**

4,779,172 A * 10/1988 Jimenez A44C 15/0015
362/104
4,894,757 A * 1/1990 Frusha A44C 15/0015
63/3
D358,562 S * 5/1995 Bulgari D11/3
D395,126 S * 6/1998 VonZwehl D11/84
D420,931 S * 2/2000 Philipson D11/14
D446,148 S * 8/2001 Kelly D11/6
6,357,260 B1 * 3/2002 Lutz A44C 15/002
63/33
D499,977 S * 12/2004 Graham D11/8
D517,443 S * 3/2006 Dennis D11/14
D519,873 S * 5/2006 Rheume D11/8

(Continued)

(21) Appl. No.: **29/604,694**
(22) Filed: **May 19, 2017**
(51) **LOC (11) Cl.** **11-01**
(52) **U.S. Cl.**
USPC **D11/11**
(58) **Field of Classification Search**
USPC D11/1-32, 34, 40-43, 79-83, 93;
D14/344; D26/39; D28/41
CPC A44C 1/00; A44C 5/00; A44C 5/0007;
A44C 5/0015; A44C 5/0023; A44C
5/003; A44C 5/0038; A44C 5/0046; A44C
5/0053; A44C 5/0061; A44C 5/0069;
A44C 5/0076; A44C 5/0084; A44C
5/0092
See application file for complete search history.

OTHER PUBLICATIONS

Jumbo LED Light Up Holiday Necklace, earliest review Dec. 28, 2016, online. Site visited Jun. 6, 2018. Internet URL:<"https://www.amazon.com/Jumbo-LED-Light-Holiday-Necklace/dp/B01N3TKJS4"> (Year: 2016).*

Primary Examiner — Cynthia Ramirez
Assistant Examiner — L. Martinez
(74) *Attorney, Agent, or Firm* — NK Patent Law

(57) **CLAIM**

The ornamental design for a necklace, as shown and described.

DESCRIPTION

FIG. 1 is a perspective view of a necklace showing my new design;
FIG. 2 is a front view thereof;
FIG. 3 is a rear view thereof;
FIG. 4 is a left side view thereof;
FIG. 5 is a top view thereof;
FIG. 6 is a bottom view thereof; and,
FIG. 7 is an enlarged front view thereof.
The broken lines in the drawing illustrate portions of the necklace that form no part of the claimed design.

1 Claim, 6 Drawing Sheets

(56) **References Cited**
U.S. PATENT DOCUMENTS
D31,544 S * 9/1899 Bagnall D11/2
D56,665 S * 11/1920 Gerbasi D2/633
D61,533 S * 10/1922 Gagnon D11/11
D123,719 S * 11/1940 Ungar D11/12
D187,043 S * 1/1960 Ratajack D11/2
D196,933 S * 11/1963 Belin D11/3
D238,292 S * 12/1975 Durante D11/11
D254,362 S * 3/1980 Minassian D11/14
D263,288 S * 3/1982 Errigo D11/8
D277,802 S * 2/1985 Luchetti D11/11

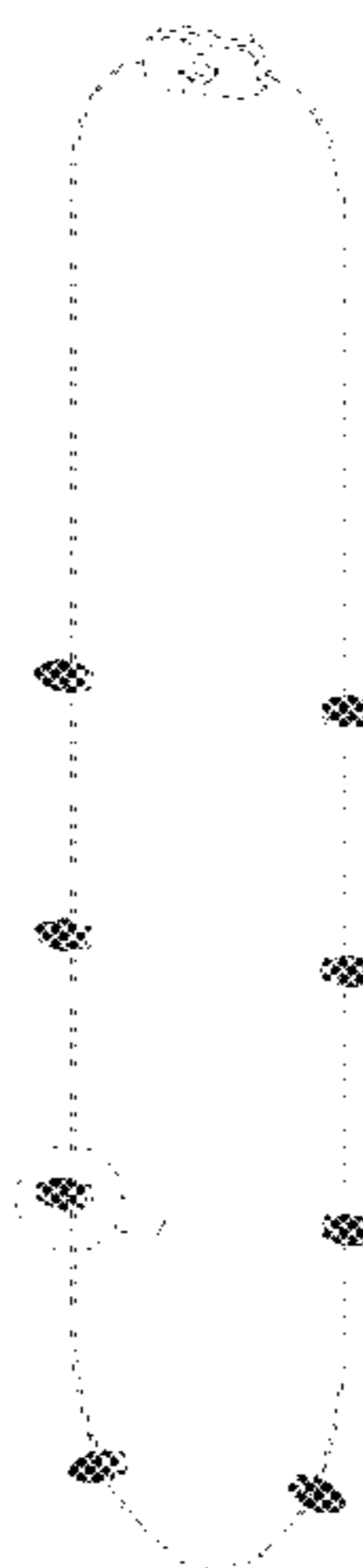

(56)

References Cited

U.S. PATENT DOCUMENTS

D556,621 S * 12/2007 Allin D11/17
 7,393,113 B2 * 7/2008 Damrau A44C 15/0015
 362/104
 D576,066 S * 9/2008 Barrickman D11/8
 D588,488 S * 3/2009 Ellia D11/11
 D644,953 S * 9/2011 Favre D11/12
 D674,769 S * 1/2013 Zimmerman D14/205
 D706,160 S * 6/2014 Pugnet D11/13
 D726,058 S * 4/2015 Caprai D11/14
 D726,573 S * 4/2015 Caprai D11/14
 D727,201 S * 4/2015 Alex D11/81
 D747,999 S * 1/2016 Yatsugi-Kang D11/7
 D780,001 S * 2/2017 Dominguez D11/6
 D780,002 S * 2/2017 Verdeille D11/6
 D810,605 S * 2/2018 Zachos D11/13
 D817,212 S * 5/2018 Qin D11/6
 D817,213 S * 5/2018 Qin D11/6
 D817,214 S * 5/2018 Qin D11/11
 D820,142 S * 6/2018 Qin D11/11
 D823,709 S * 7/2018 Qin D11/11
 D828,774 S * 9/2018 Qin D11/11
 D828,775 S * 9/2018 Qin D11/11
 D828,776 S * 9/2018 Qin D11/11
 D828,777 S * 9/2018 Qin D11/11
 2006/0044788 A1 * 3/2006 Damrau A44C 15/0015
 362/104
 2012/0291233 A1 * 11/2012 Wilkinson A41F 15/00
 24/302
 2017/0202320 A1 * 7/2017 Tanaka A44C 5/00

* cited by examiner

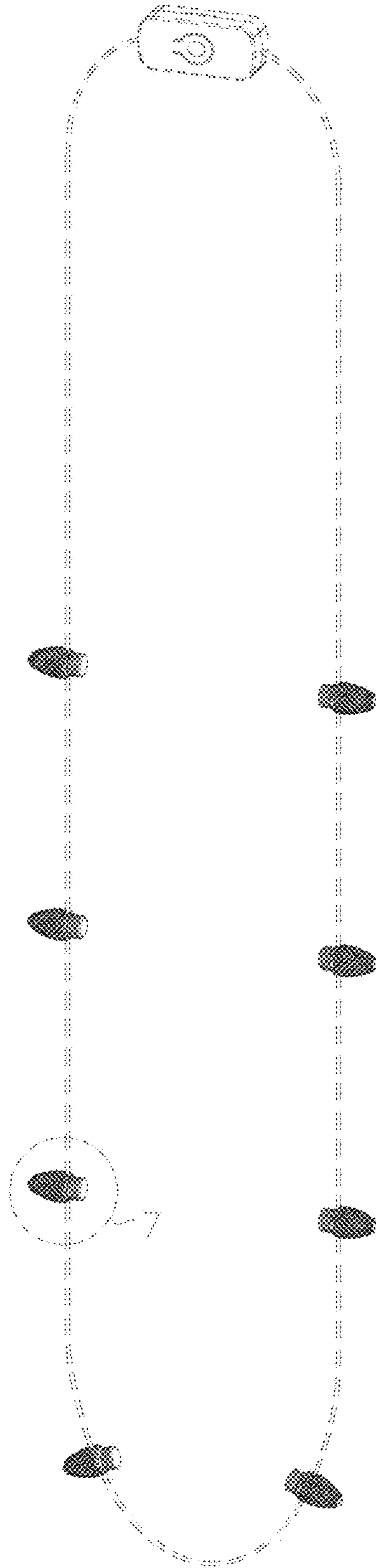

FIG. 1

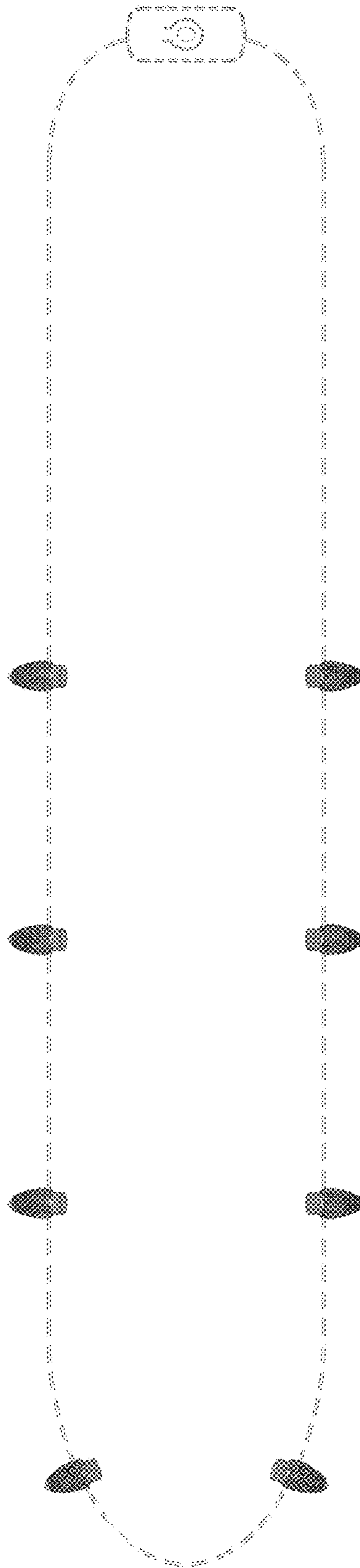

FIG. 2

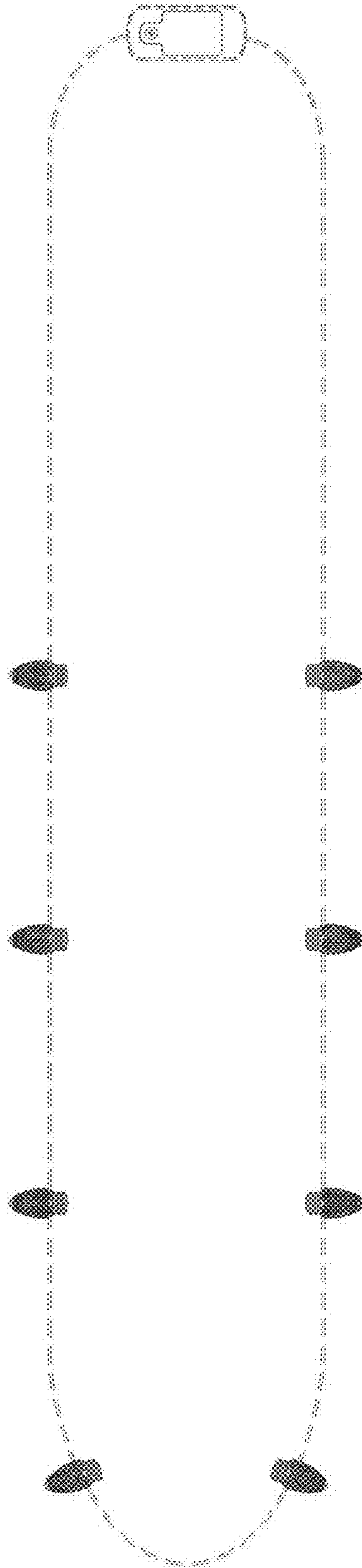

FIG.3

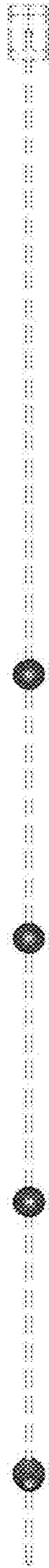

FIG.4

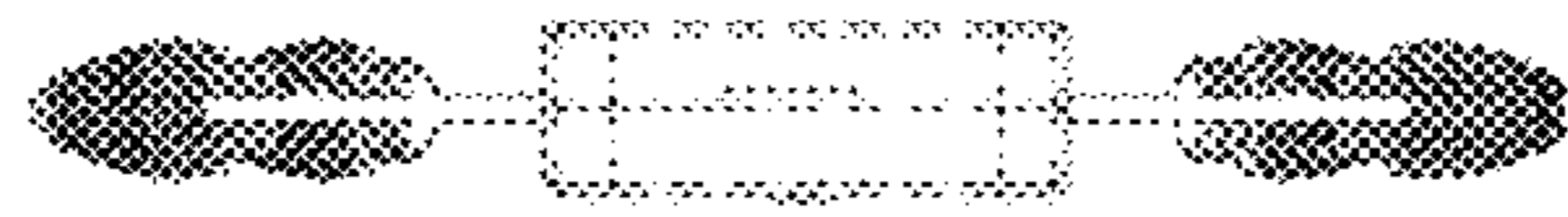

FIG. 5

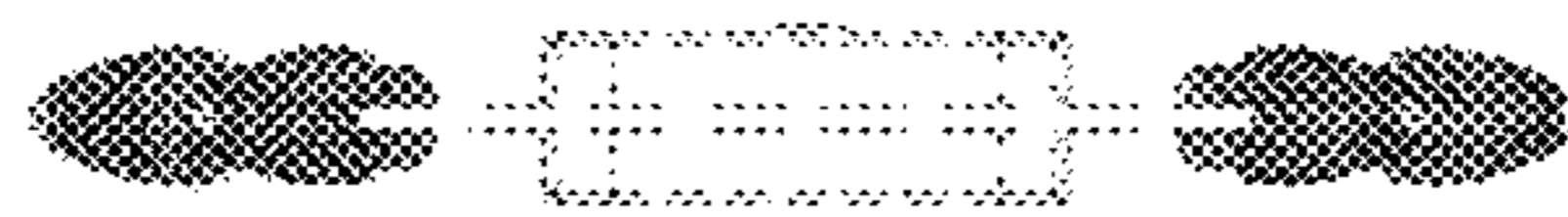

FIG. 6

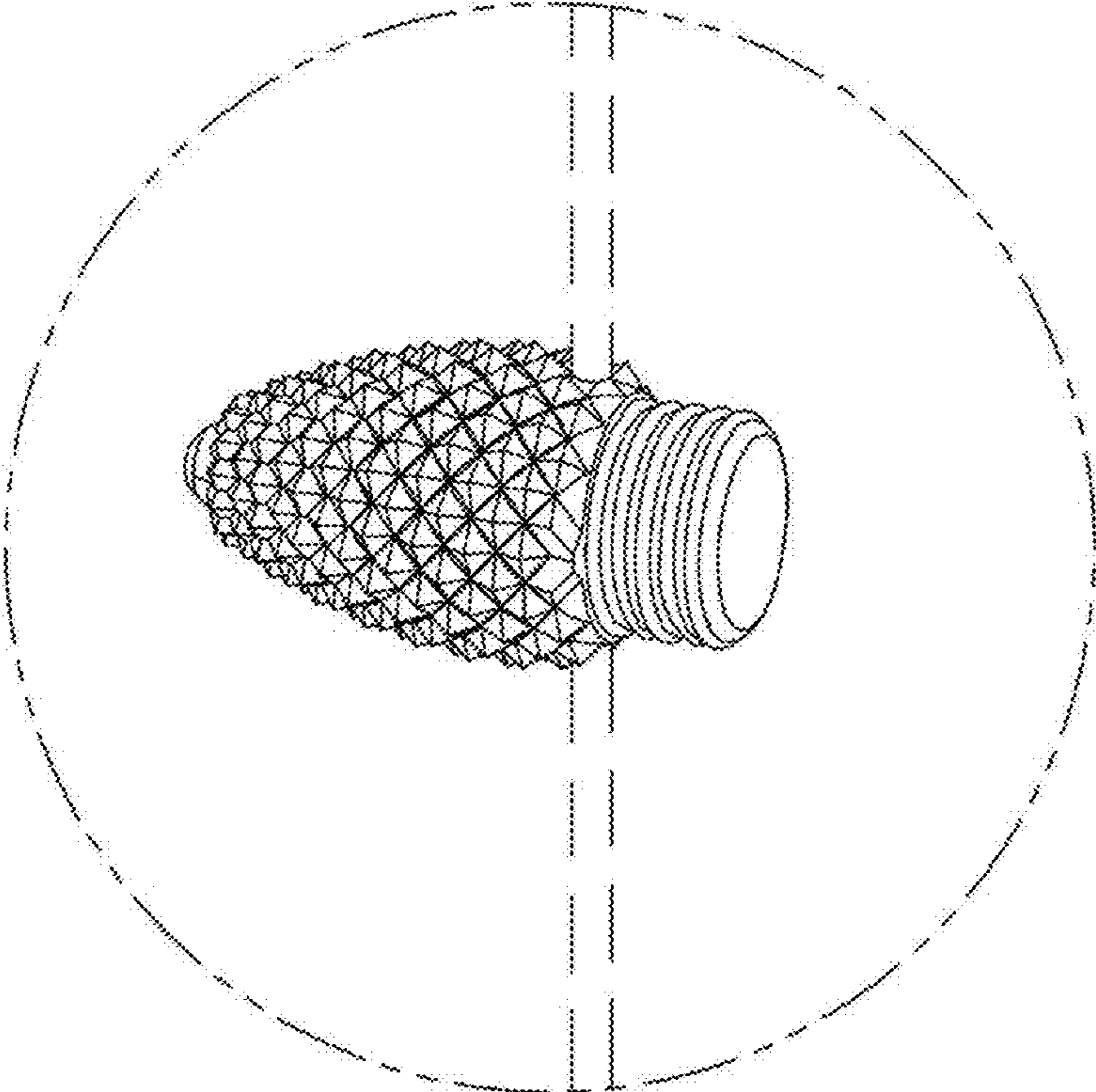

FIG.7