



US00D842112S

(12) **United States Design Patent**
Cortadellas et al.

(10) **Patent No.:** **US D842,112 S**
(45) **Date of Patent:** **** Mar. 5, 2019**

(54) **CONTAINER**

(71) Applicant: **PepsiCo, Inc.**, Purchase, NY (US)

(72) Inventors: **Xavi Cortadellas**, Miami, FL (US);
Christopher Michael Hintermeister,
Highland Park, IL (US); **Sean Joseph
Huls**, Chicago, IL (US); **Drew
Alexander Read Palin**, Kenilworth, IL
(US); **Sameer Kirti Talsania**, Chicago,
IL (US); **Bruce Joseph Ankenbrandt**,
Holland, OH (US); **Tracy Momany**,
Sylvania, OH (US); **John Lester
Ostby**, Seattle, WA (US); **Alexander
Daniel Warren**, Seattle, WA (US)

(73) Assignee: **PepsiCo, Inc.**, Purchase, NY (US)

(**) Term: **15 Years**

(21) Appl. No.: **29/609,475**

(22) Filed: **Jun. 30, 2017**

(51) **LOC (11) Cl.** **09-01**

(52) **U.S. Cl.**
USPC **D9/516; D9/520**

(58) **Field of Classification Search**
USPC D9/414, 424, 428, 434–435, 454, 500,
D9/503–504, 516, 519–520, 529, 549,
D9/558, 715; D7/400, 601–602, 608,
D7/612, 615, 629–630; D26/6, 9–11, 22
CPC B65D 1/00; B65D 1/02; B65D 1/0223;
B65D 23/00; B65D 81/00; B65D
2501/00; B65D 2501/0009; B65D 1/0261;
B65D 1/0284

See application file for complete search history.

(56) **References Cited**

U.S. PATENT DOCUMENTS

D192,655 S * 4/1962 Sarafan D9/520
D230,470 S * 2/1974 Frohn D9/520

D379,763 S * 6/1997 Ewing, Jr. D9/520
D414,112 S * 9/1999 Waggaman D9/520
D482,794 S * 11/2003 Whitley D24/121
D542,136 S * 5/2007 Lilico D9/520
D548,092 S * 8/2007 Klemm D9/520
D551,080 S * 9/2007 Pedmo B65D 1/0276
D9/516
D570,217 S * 6/2008 Meillerais D9/502
D572,134 S * 7/2008 Bourne D9/500
D606,410 S * 12/2009 Kissinger D9/516
D650,677 S * 12/2011 Wurster D9/516

(Continued)

FOREIGN PATENT DOCUMENTS

DE 402010000802-0003 1/2010
FI 9918 9/1986

(Continued)

Primary Examiner — Dana Meyrow

(74) *Attorney, Agent, or Firm* — Sterne, Kessler,
Goldstein & Fox P.L.L.C.

(57) **CLAIM**

The ornamental design for a container, as shown and
described.

DESCRIPTION

FIG. 1 is a top front perspective view of a container showing
the claimed design;
FIG. 2 is a bottom front perspective view thereof;
FIG. 3 is a front view thereof;
FIG. 4 is a rear view thereof;
FIG. 5 is a left side view thereof;
FIG. 6 is a right side view thereof;
FIG. 7 is a top view thereof; and,
FIG. 8 is a bottom view thereof.

The dashed broken lines in the figures show portions of the
container that form no part of the claimed design.

The dot-dash broken lines in the figures show boundaries
that form no part of the claimed design.

1 Claim, 8 Drawing Sheets

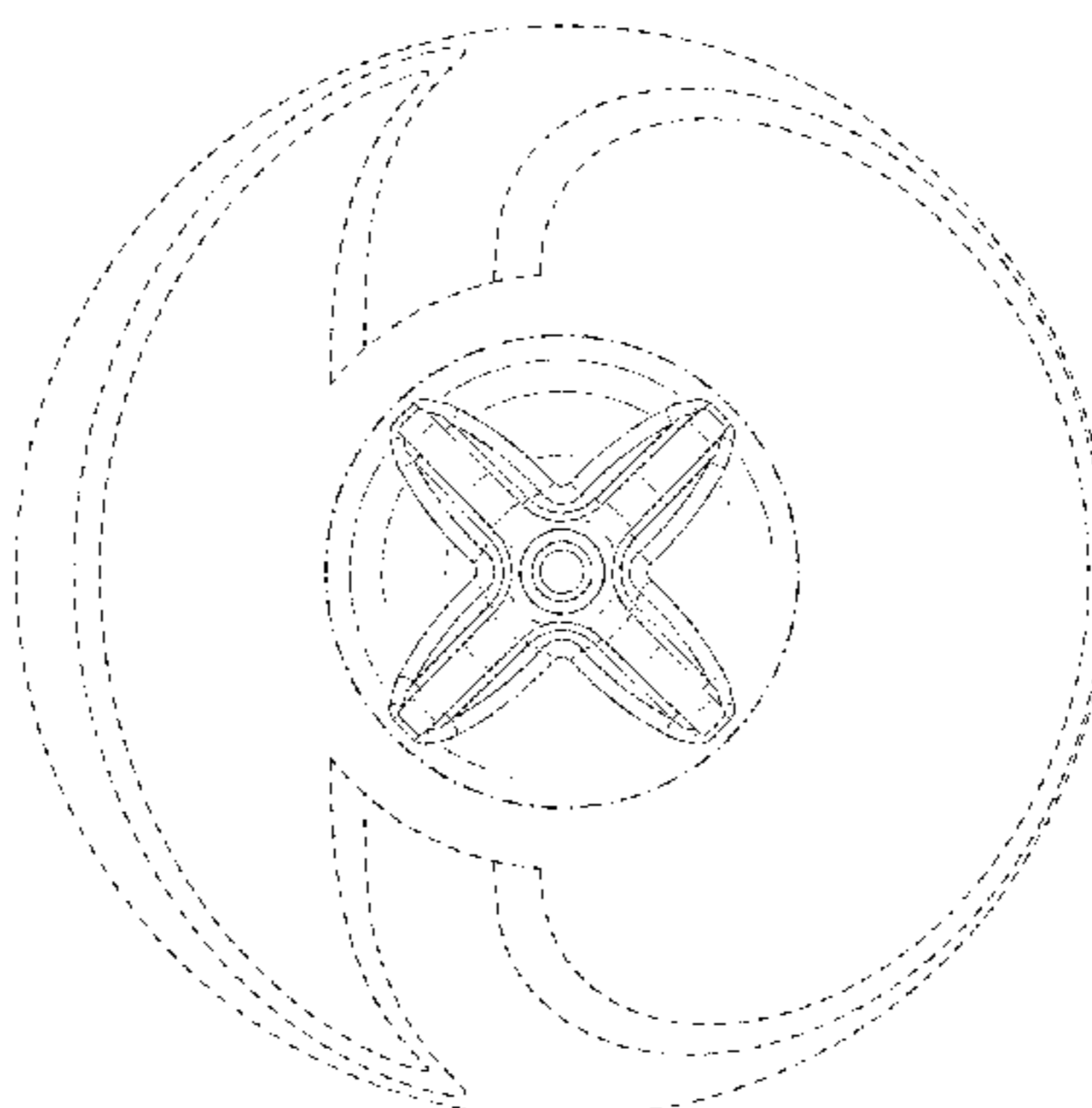
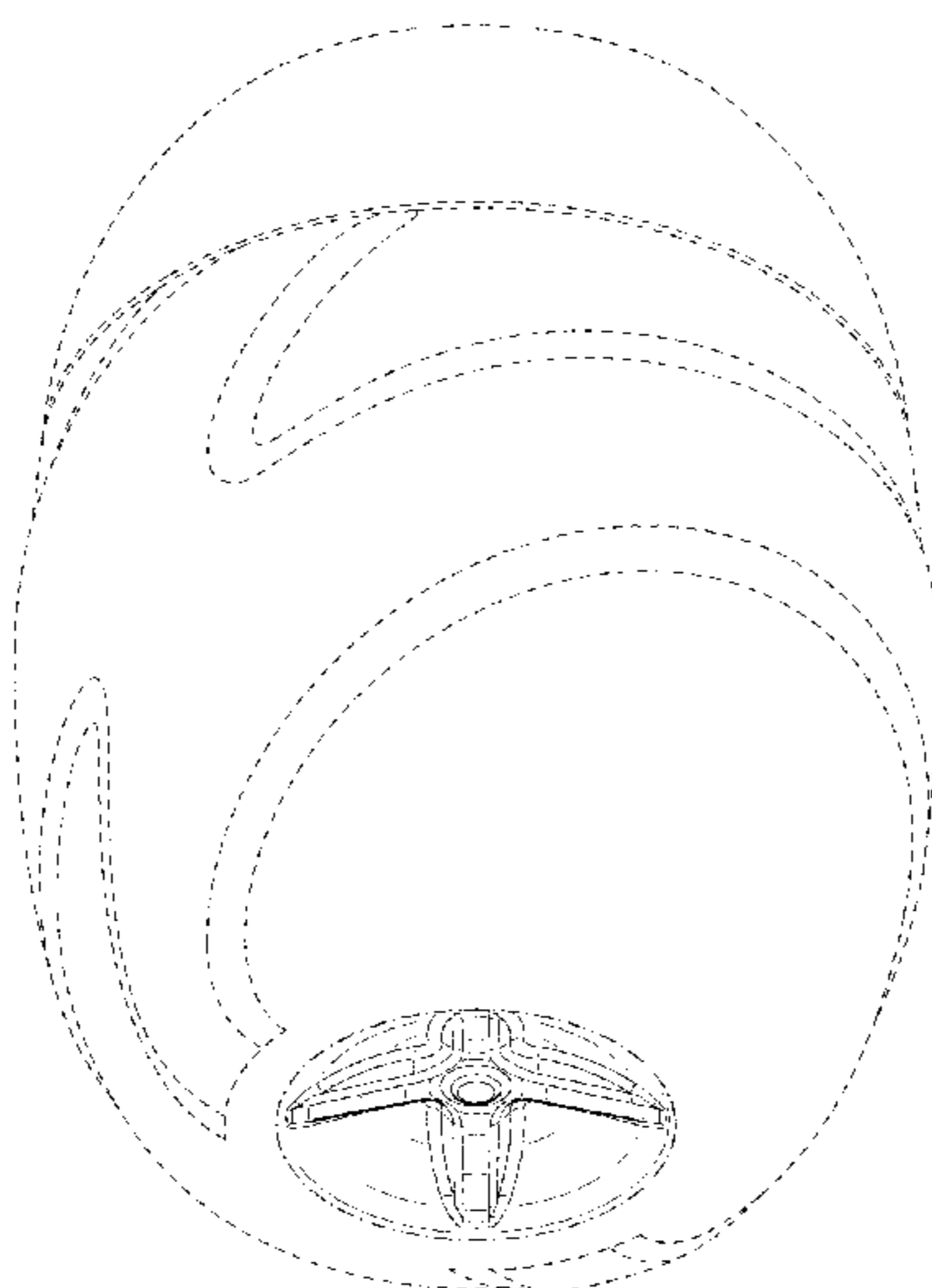

(56)

References Cited

U.S. PATENT DOCUMENTS

D699,578 S 2/2014 Marina et al.
D701,767 S 4/2014 Marina et al.
D705,068 S * 5/2014 Janssen D9/516
D722,503 S * 2/2015 Smith D9/516
8,991,628 B2 * 3/2015 Wurster B65D 1/0261
215/370
D799,967 S * 10/2017 Wade D9/500
D815,951 S * 4/2018 Solovy D9/558

FOREIGN PATENT DOCUMENTS

JP D965582 10/1996
KR 30-0477693 1/2008

* cited by examiner

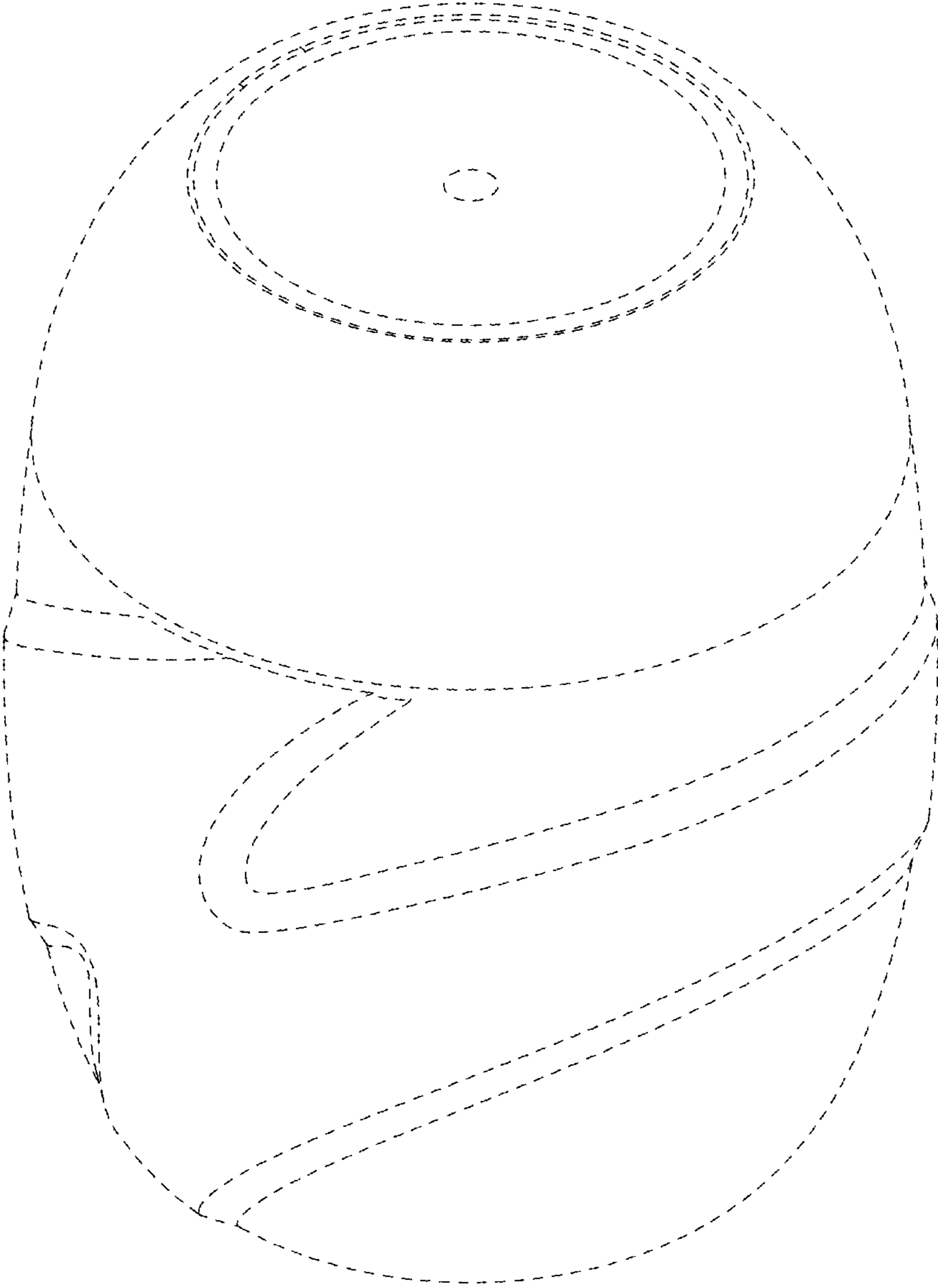

FIG. 1

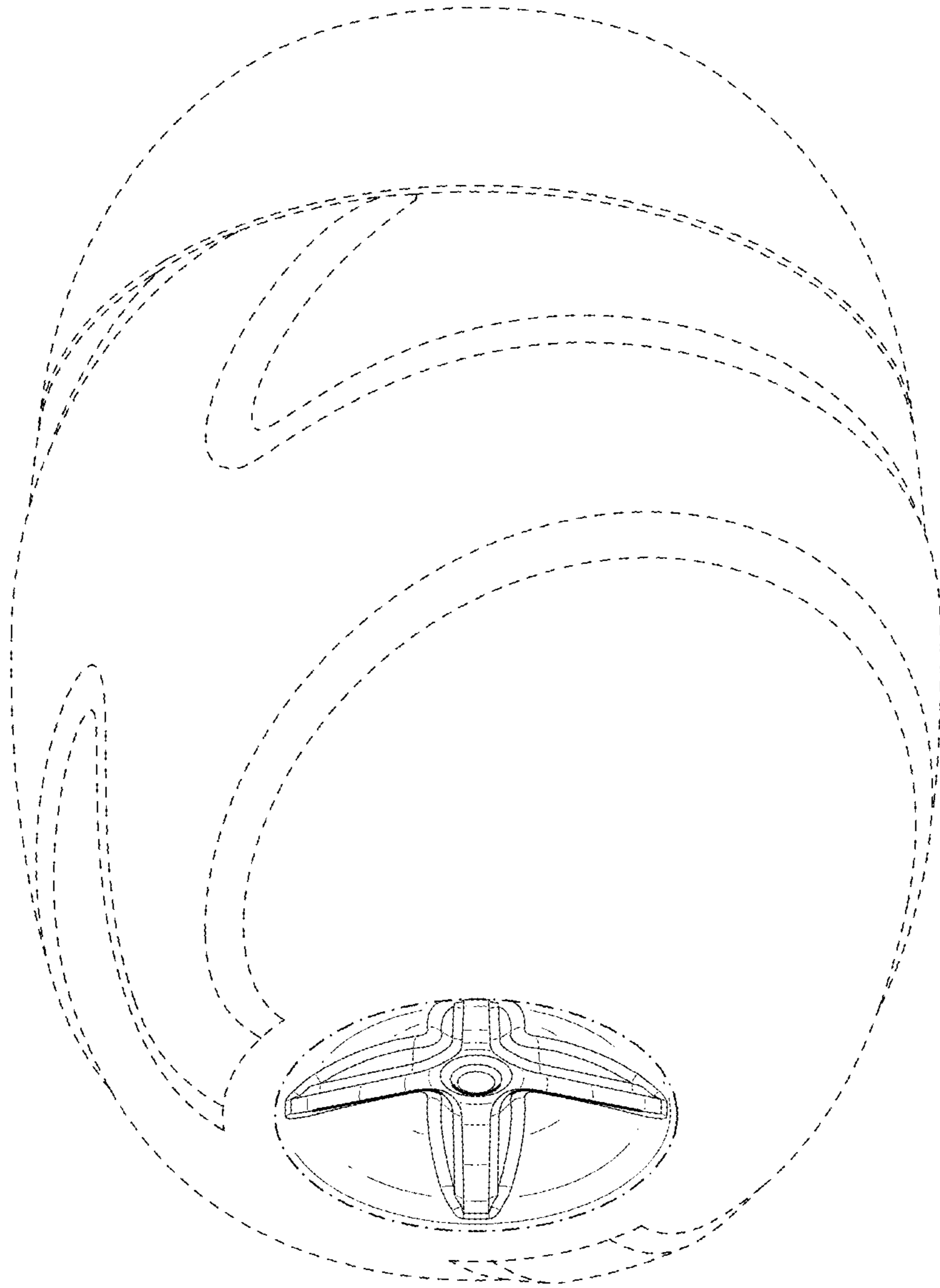

FIG. 2

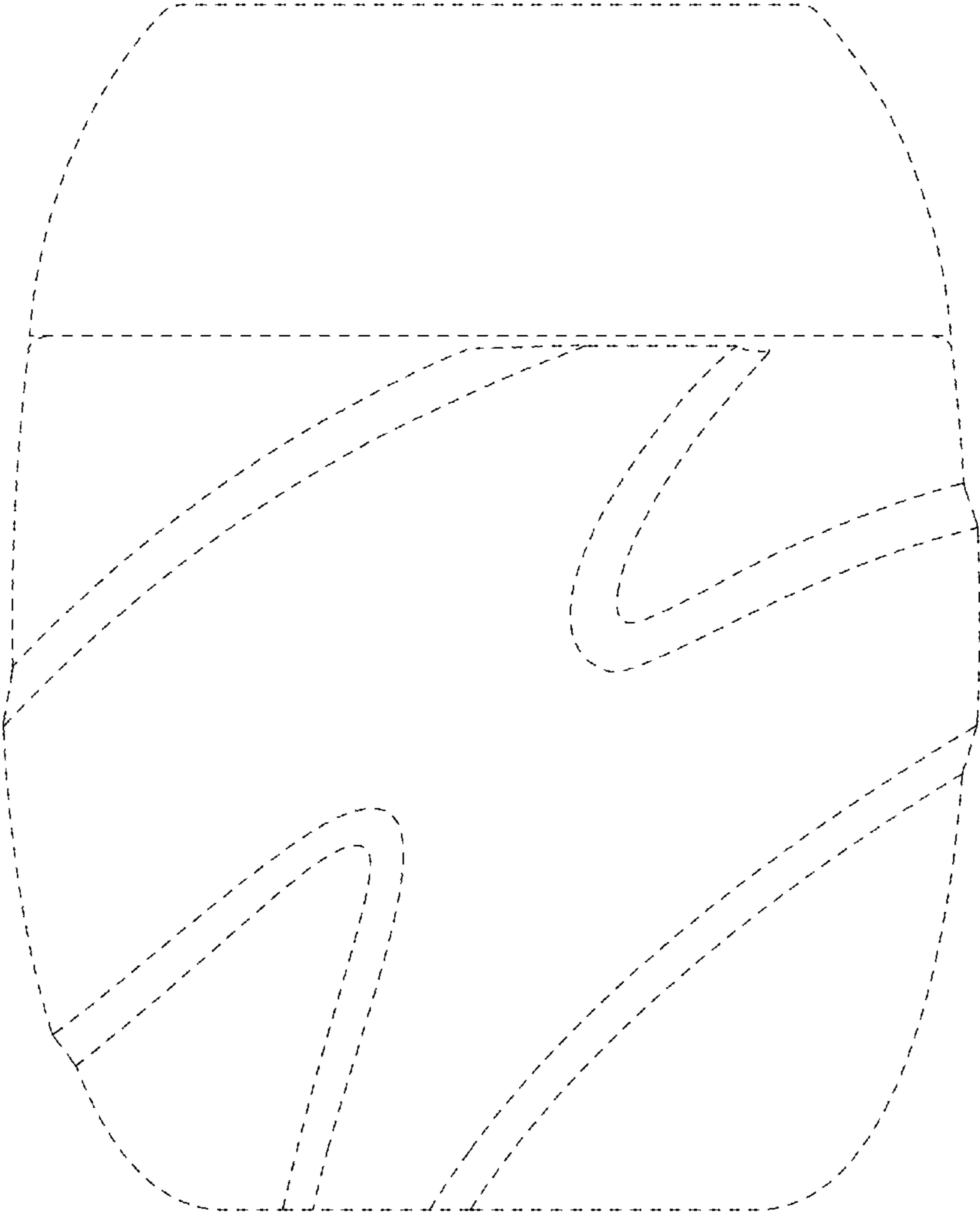

FIG. 3

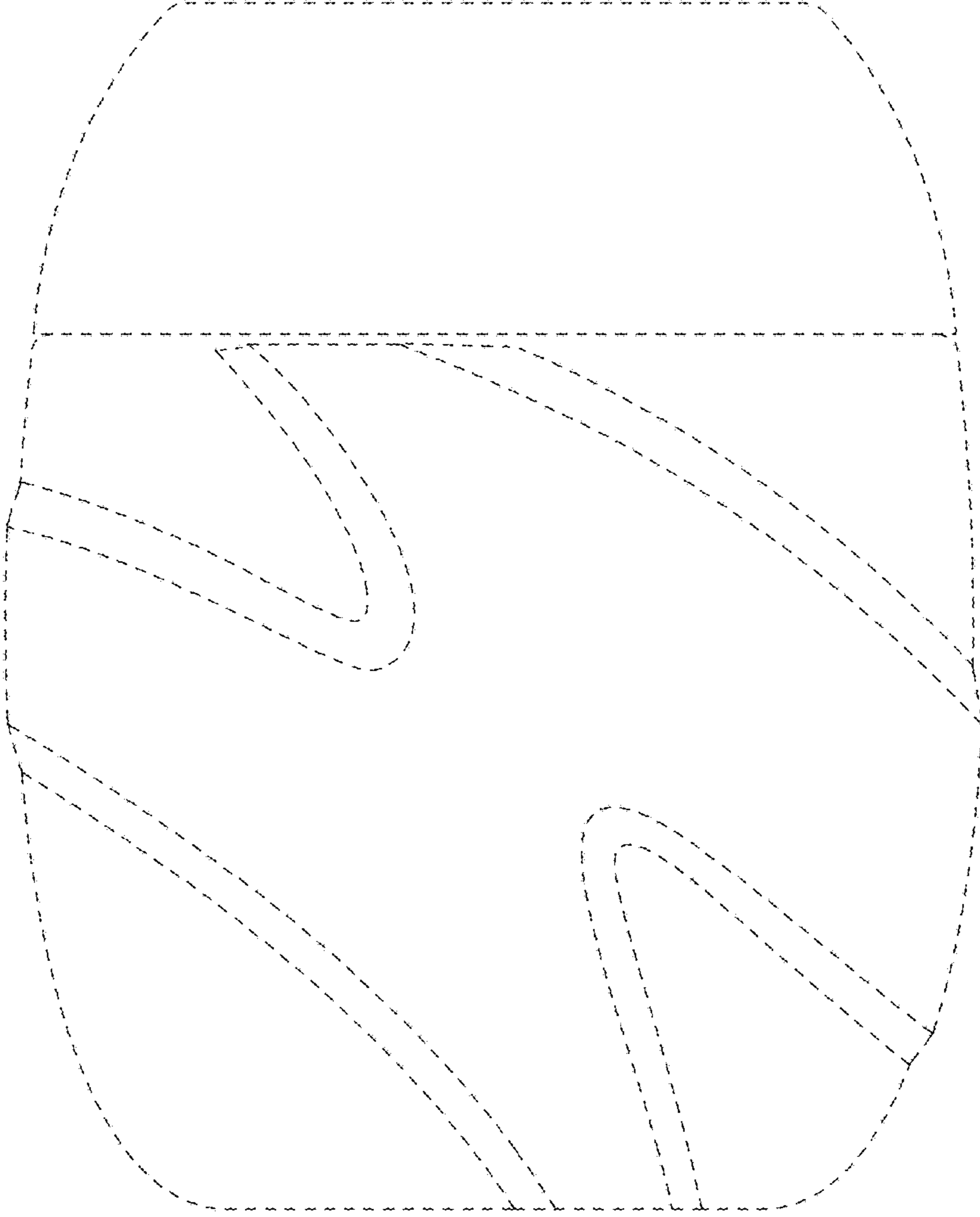

FIG. 4

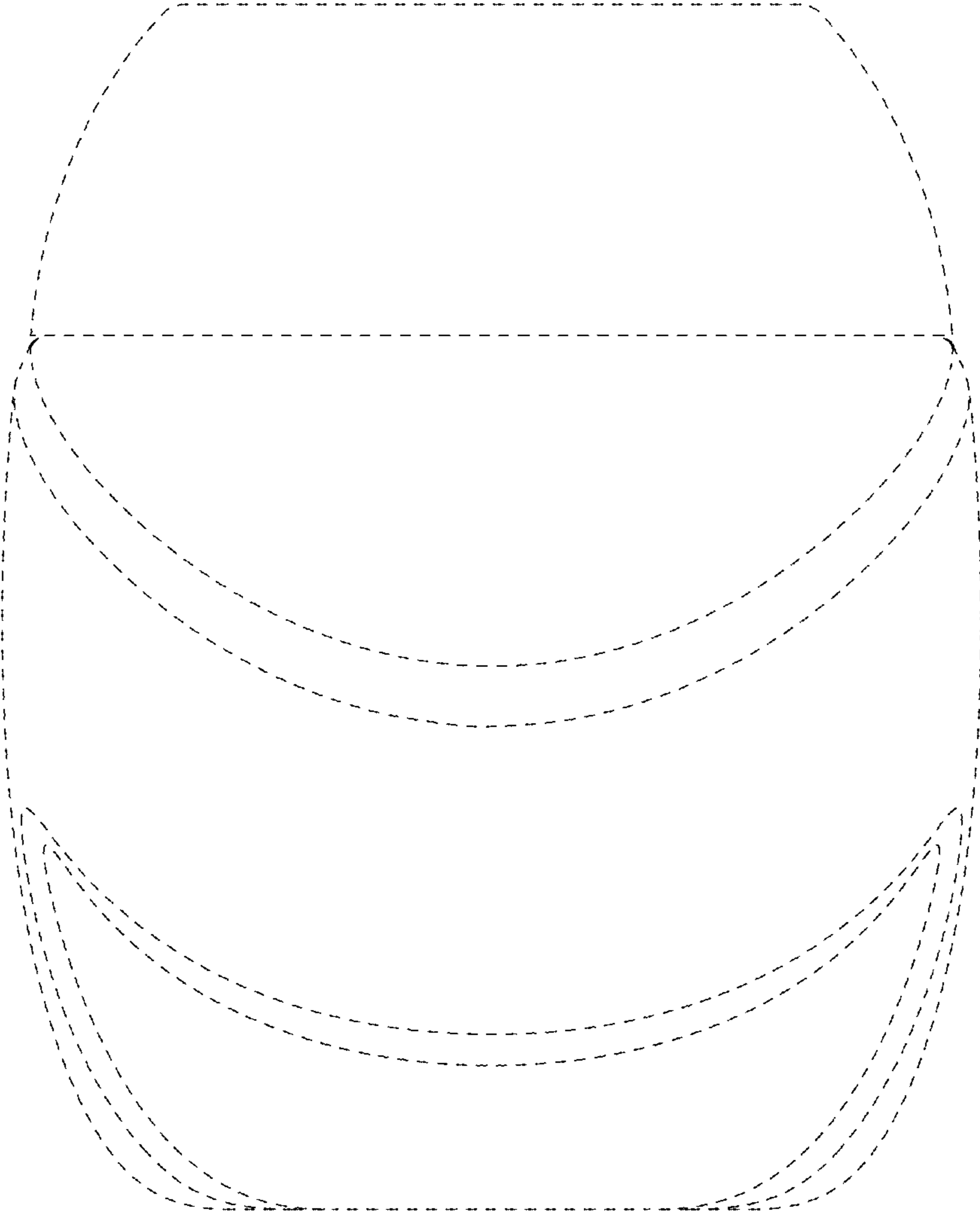

FIG. 5

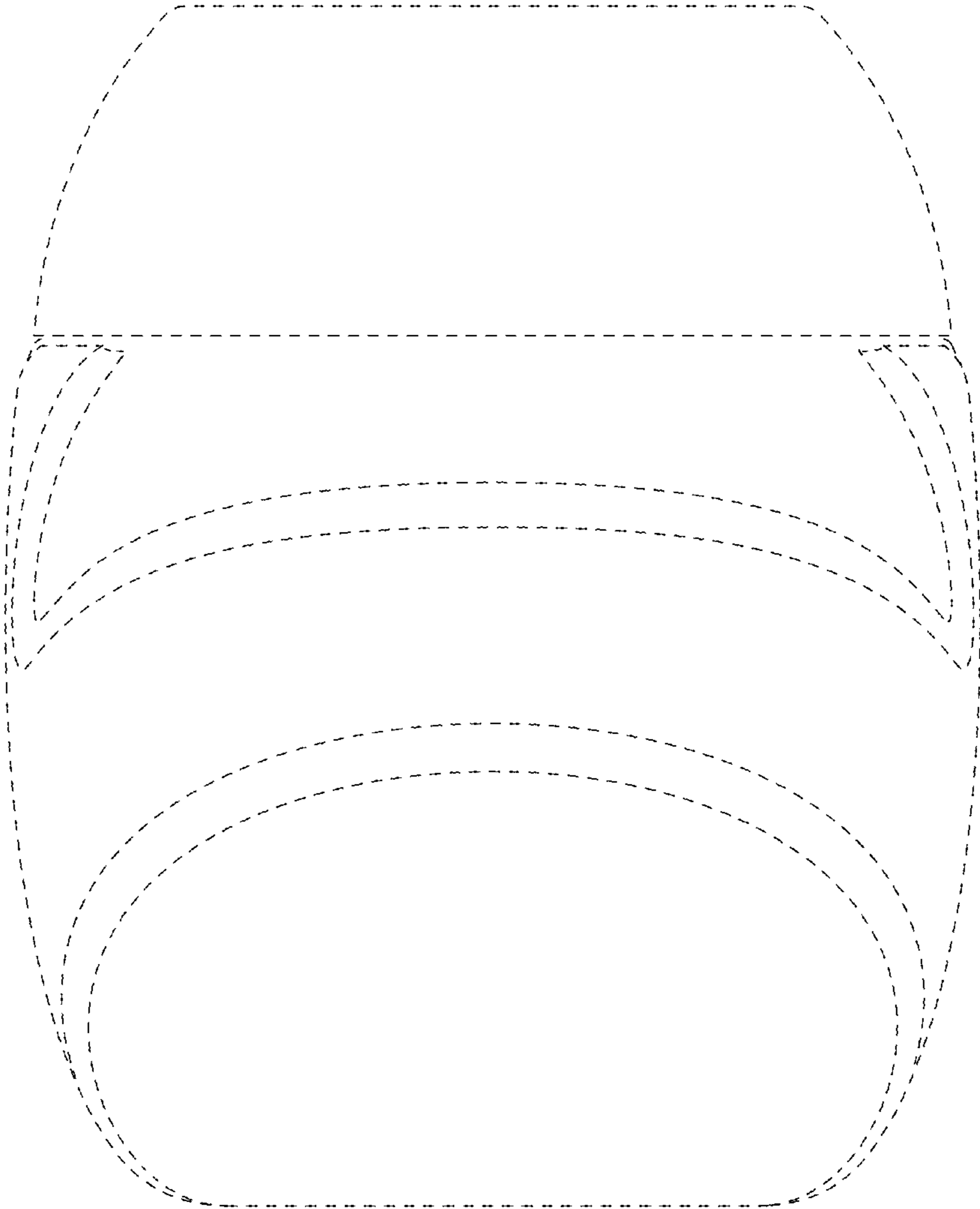

FIG. 6

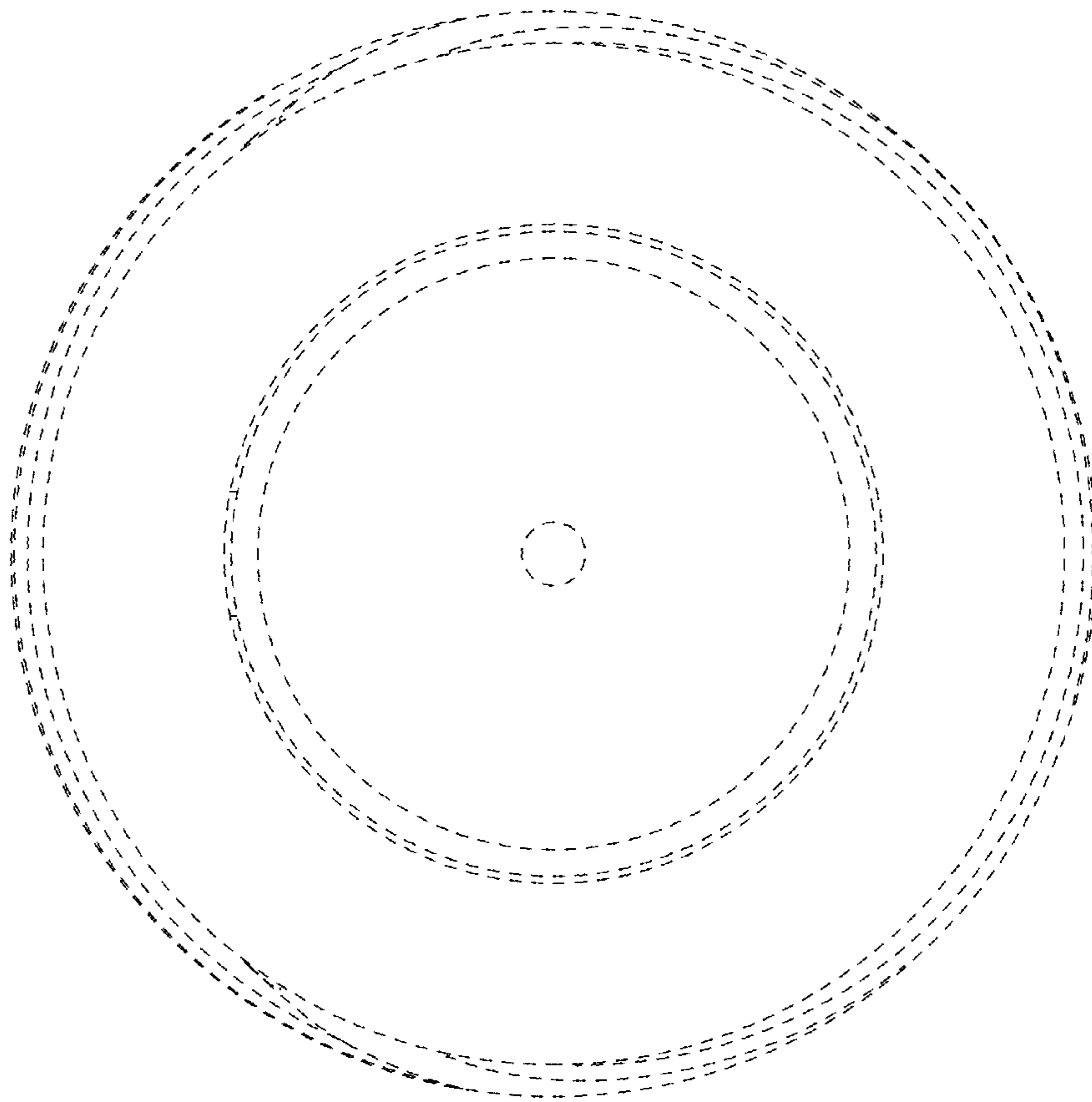

FIG. 7

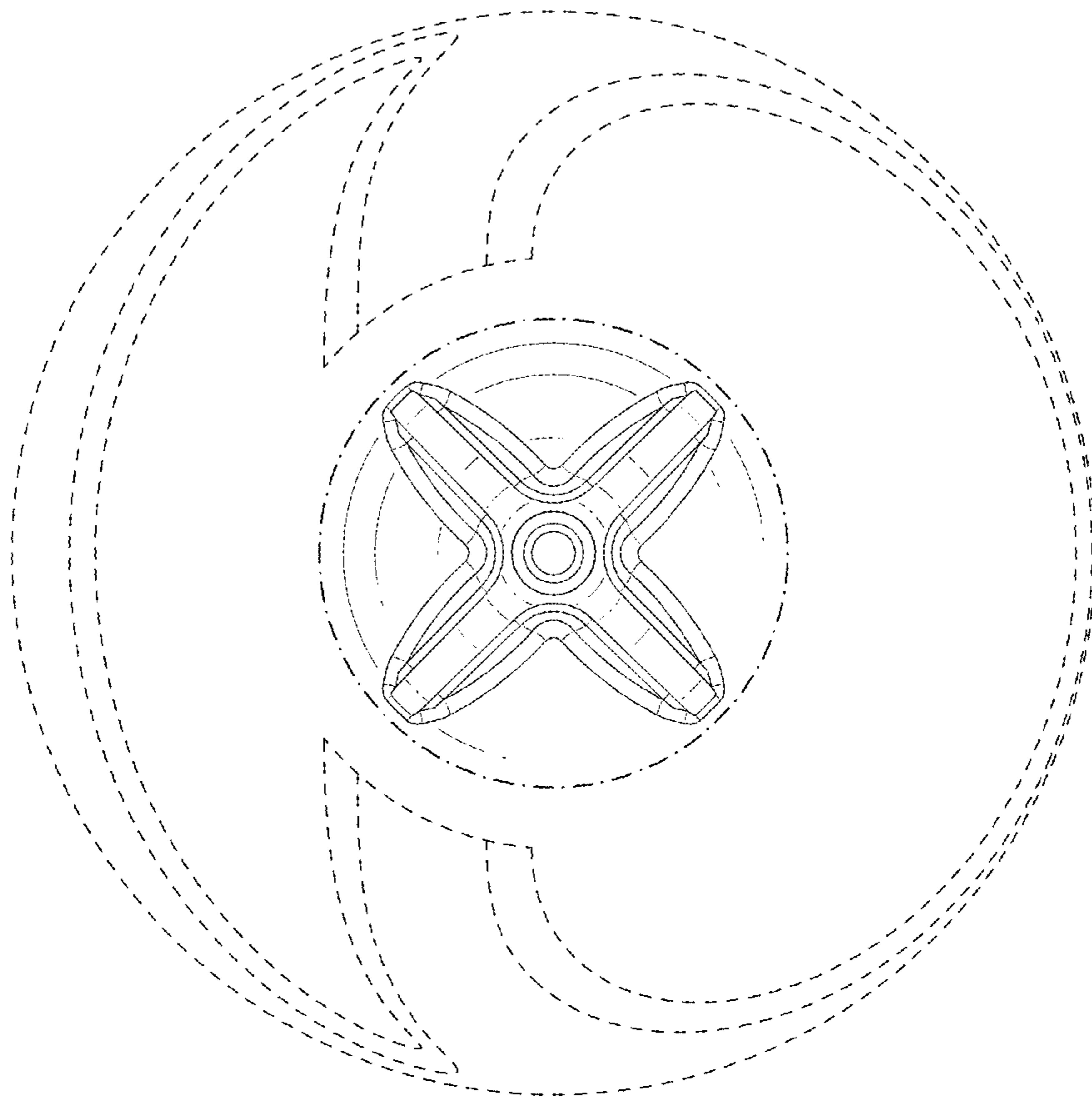

FIG. 8