

US00D842014S

(12) **United States Design Patent**
Qiu et al.

(10) **Patent No.:** **US D842,014 S**
(45) **Date of Patent:** **** Mar. 5, 2019**

- (54) **PRODUCT DISPLAY UNIT**
- (71) Applicant: **Evergreen Enterprises of Virginia, LLC**, Richmond, VA (US)
- (72) Inventors: **Fei Qiu**, Richmond, VA (US); **Brittany Toler**, Midlothian, VA (US); **Shannon Leigh Cowan**, Henrico, VA (US)
- (73) Assignee: **Evergreen Enterprises of Virginia, LLC**, Richmond, VA (US)
- (**) Term: **15 Years**

D456,167 S *	4/2002	Harwanko	D6/548
D458,770 S *	6/2002	Walter	D6/681.1
D466,331 S *	12/2002	Chang	D6/681.1
D470,685 S *	2/2003	Chang	D6/681.1
D474,350 S *	5/2003	Sardis	D6/681.1
D486,982 S *	2/2004	Hessell	D6/675.4
D491,742 S *	6/2004	Harwanko	D6/681.1
D495,523 S *	9/2004	Harwanko	D6/681.1
D495,524 S *	9/2004	Harwanko	D6/681.1
D602,713 S *	10/2009	Stukenberg	D6/681.1
7,946,435 B2 *	5/2011	Clark	A47F 5/103 211/189
D668,894 S *	10/2012	Denby	D6/708
D677,932 S *	3/2013	Wang	D6/681.1
D693,478 S *	11/2013	Irick	D24/158

(Continued)

- (21) Appl. No.: **29/619,352**
- (22) Filed: **Sep. 28, 2017**
- (51) **LOC (11) Cl.** **06-04**
- (52) **U.S. Cl.**
USPC **D6/681.2**
- (58) **Field of Classification Search**
USPC D6/672, 675, 675.2, 681, 681.1, 681.2,
D6/681.3, 682.5
CPC A47F 3/00; A47F 3/06; A47F 3/08; A47F
5/00; A47F 5/0006; A47F 5/0018; A47F
5/0031; A47F 5/01; A47F 5/13; A47F
7/0014; A47F 7/0042; A47F 7/16; A47B
61/00

See application file for complete search history.

(56) **References Cited**

U.S. PATENT DOCUMENTS

D199,570 S *	11/1964	Van Dusen et al.	D6/681.1
D358,952 S *	6/1995	Stein	D6/681.2
D369,040 S *	4/1996	Lechleiter	D6/672
D370,370 S *	6/1996	Brown	D6/681.2
5,535,898 A *	7/1996	Burgess, Sr.	B62B 3/108 211/189
5,653,349 A *	8/1997	Dana	F16B 12/34 211/189
D450,948 S *	11/2001	Stafford	D6/681.1

OTHER PUBLICATIONS

Dimension Doormats, Embossed Doormat Display, Evergreen Enterprises (2017).

Primary Examiner — John Mindmuller

Assistant Examiner — Steven J Czyz

(74) *Attorney, Agent, or Firm* — Jordan IP Law, LLC;
Todd A. Vaughn

(57) **CLAIM**

The ornamental design for a product display unit, as shown and described.

DESCRIPTION

FIG. 1 is a perspective view of a product display unit;

FIG. 2 is a front view thereof;

FIG. 3 is a rear view thereof;

FIG. 4 is a right side view thereof;

FIG. 5 is a left side view thereof;

FIG. 6 is a top view thereof; and,

FIG. 7 is a top view thereof.

The broken lines depict portions of the article that form no part of the claimed design.

1 Claim, 7 Drawing Sheets

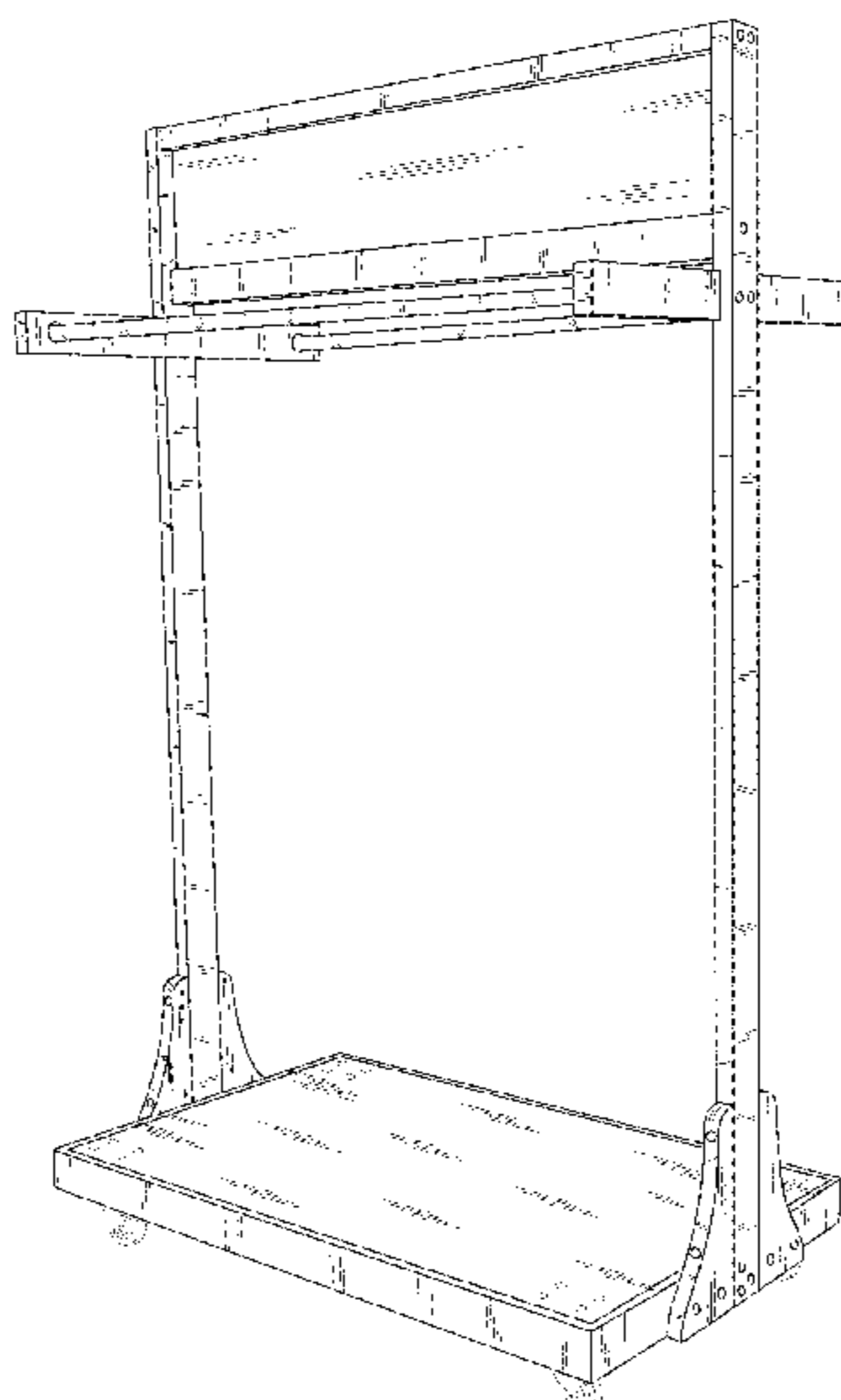

(56)

References Cited

U.S. PATENT DOCUMENTS

8,959,813	B2 *	2/2015	Denby	A47F 5/10 211/175
9,119,487	B2 *	9/2015	Angvall	A47F 5/0081
D745,794	S *	12/2015	Knoll	D6/681
D750,401	S *	3/2016	Ruiz	D6/681
D767,926	S *	10/2016	Denby	D6/705
9,468,312	B2 *	10/2016	Denby	A47F 5/0043
D785,381	S *	5/2017	Johnson	D6/681
D809,835	S *	2/2018	Greenspon	D6/681
2011/0079566	A1 *	4/2011	Nakamichi	G09F 7/18 211/85.26

* cited by examiner

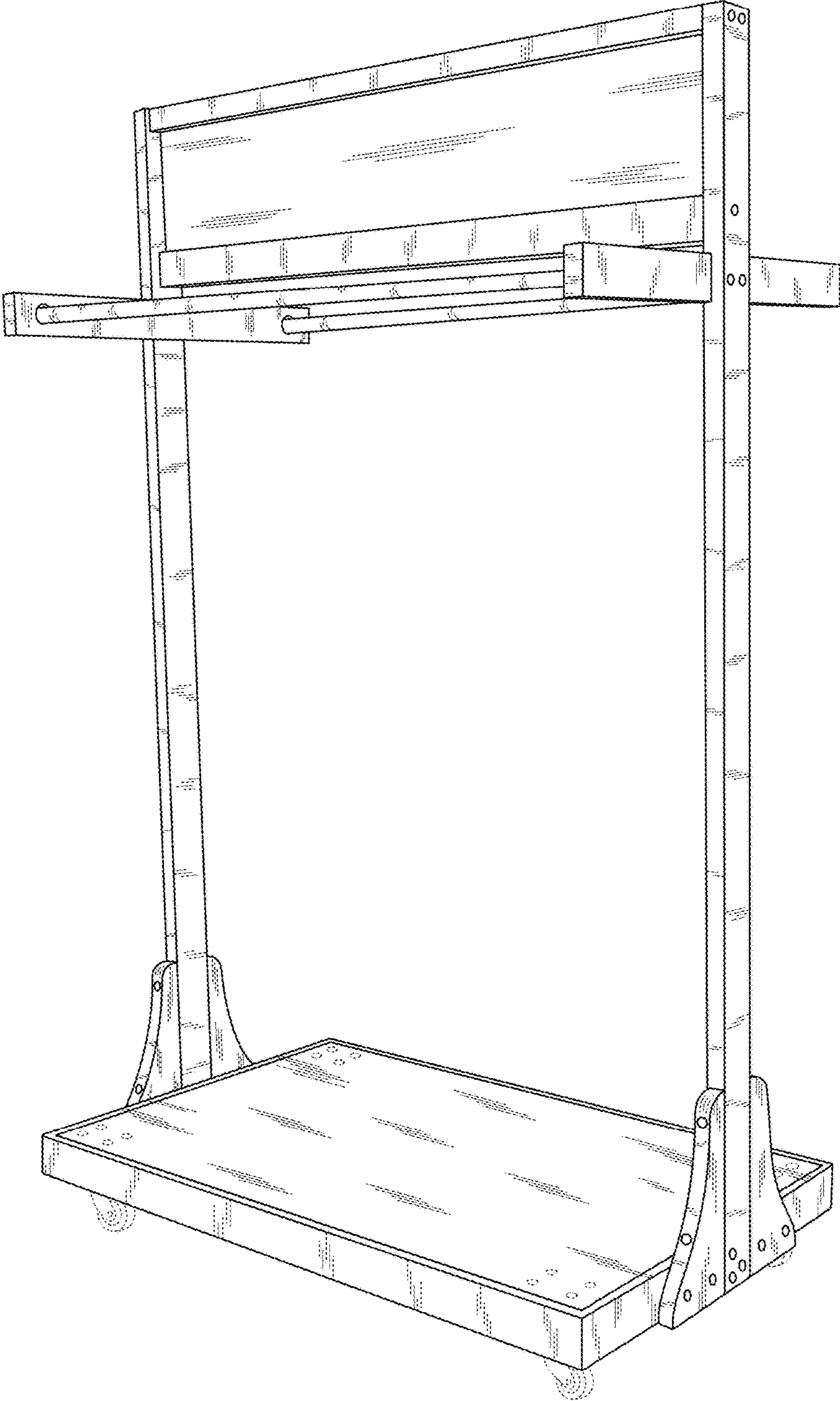

FIG. 1

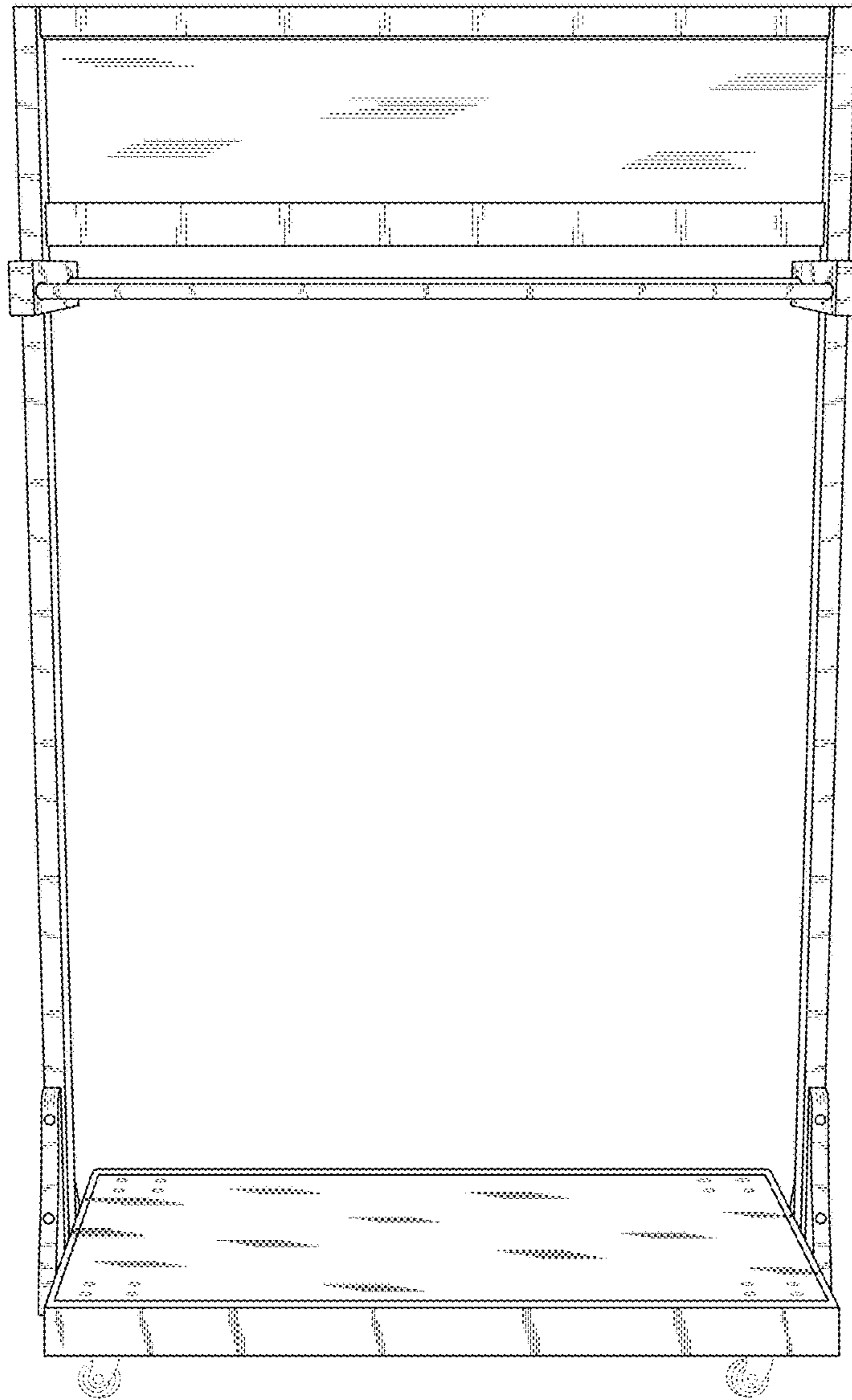

FIG. 2

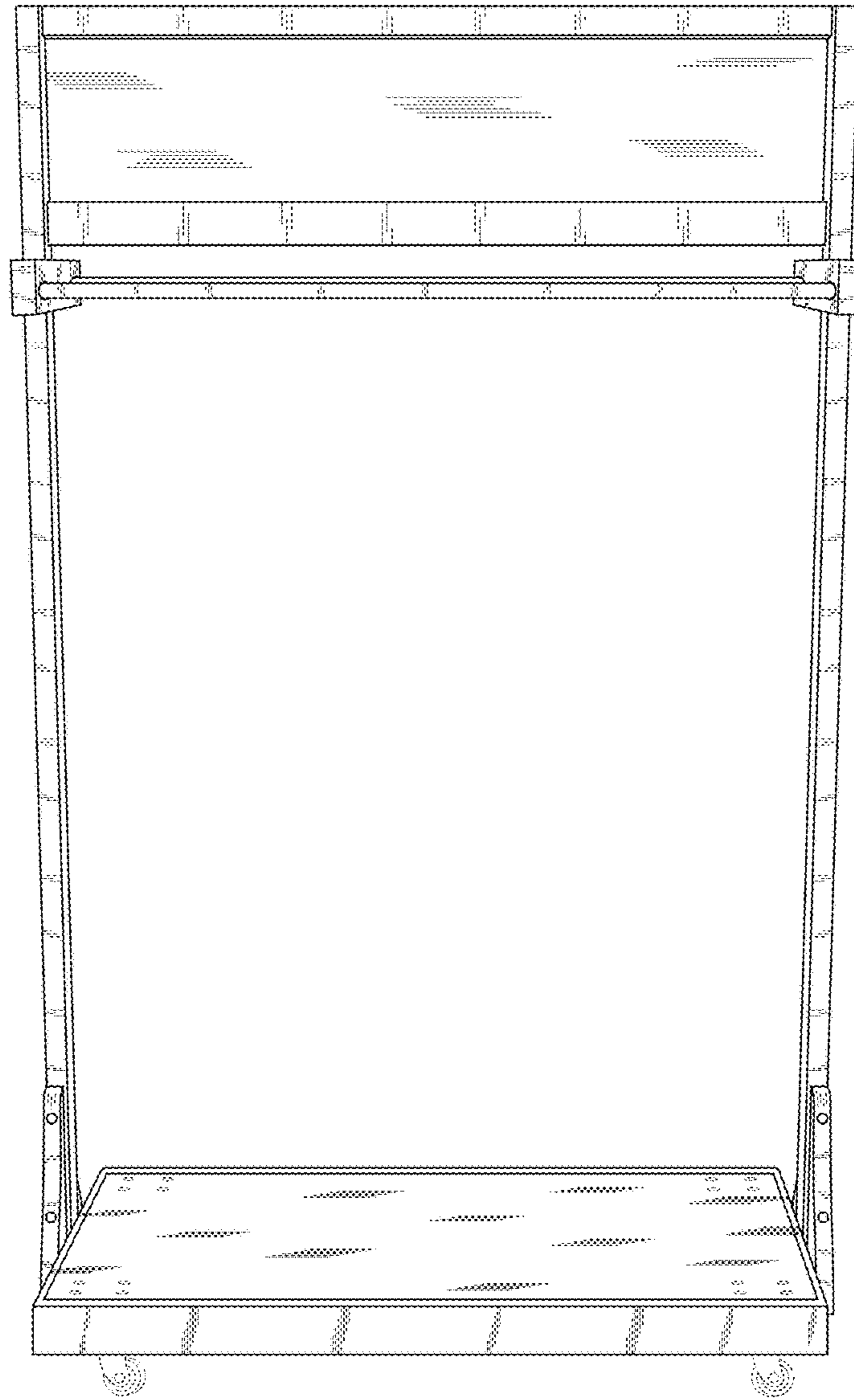

FIG. 3

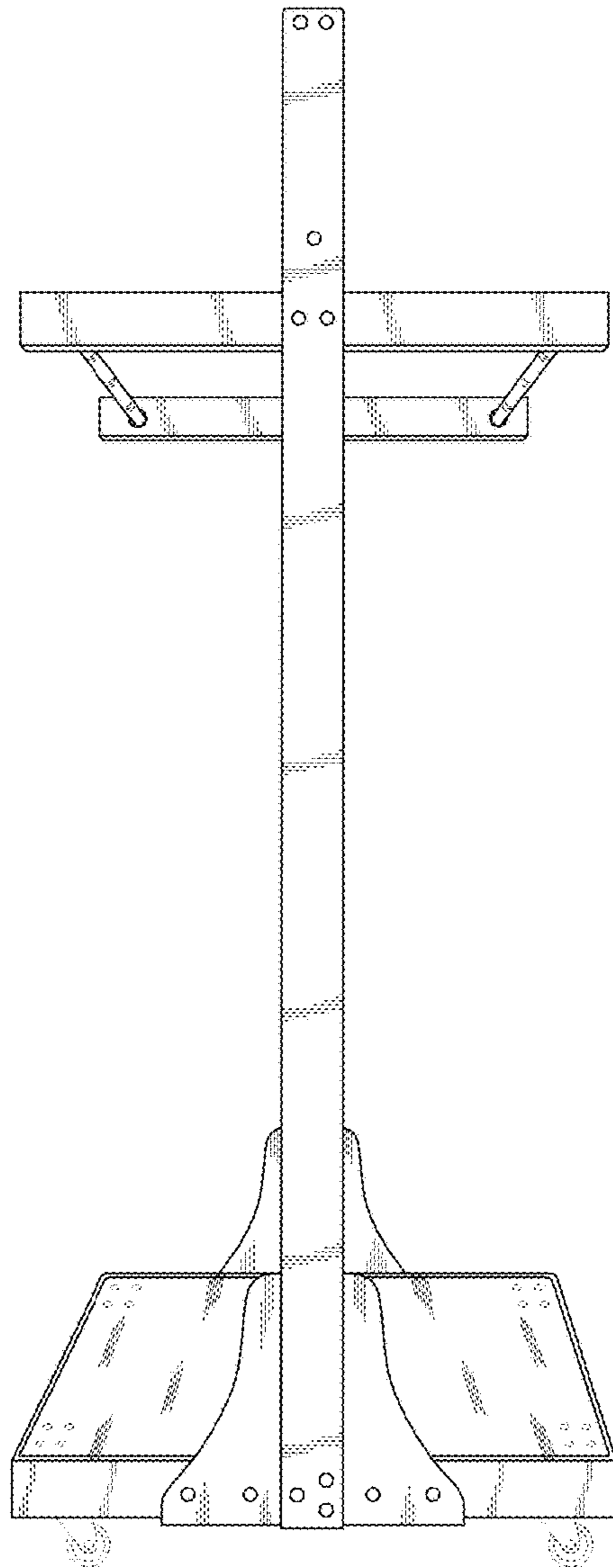

FIG. 4

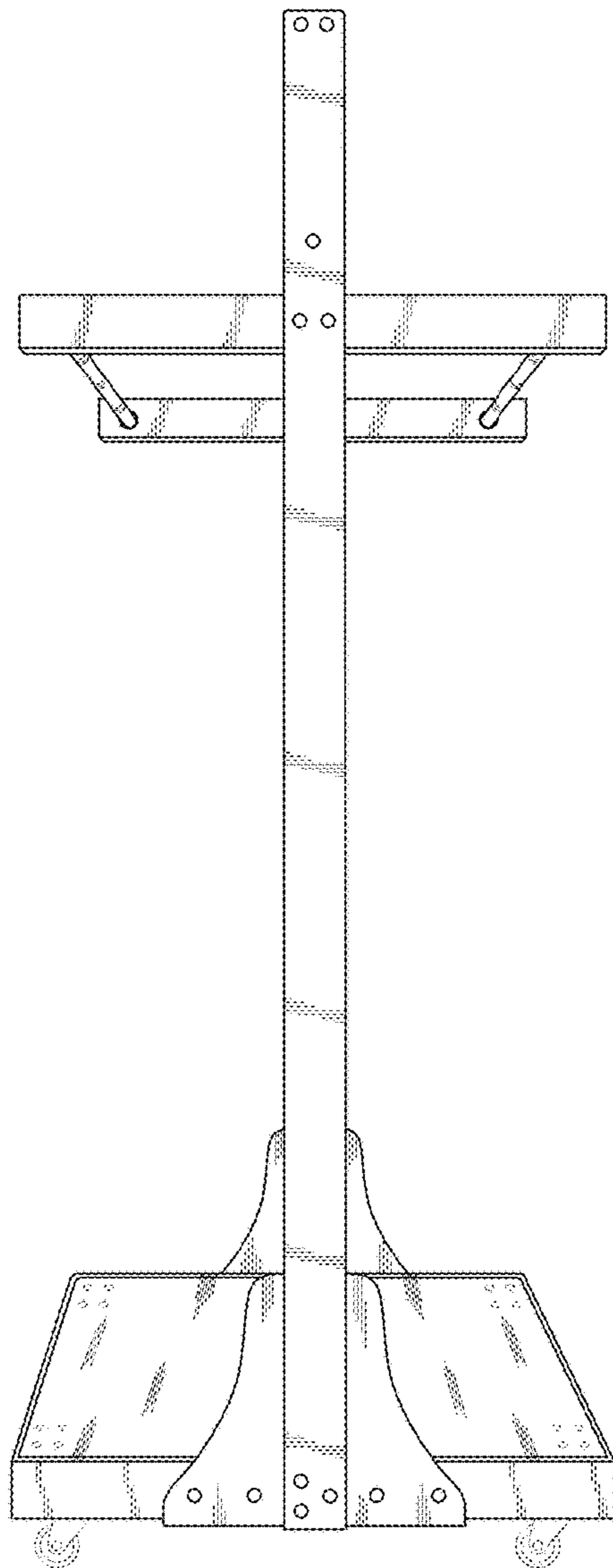

FIG. 5

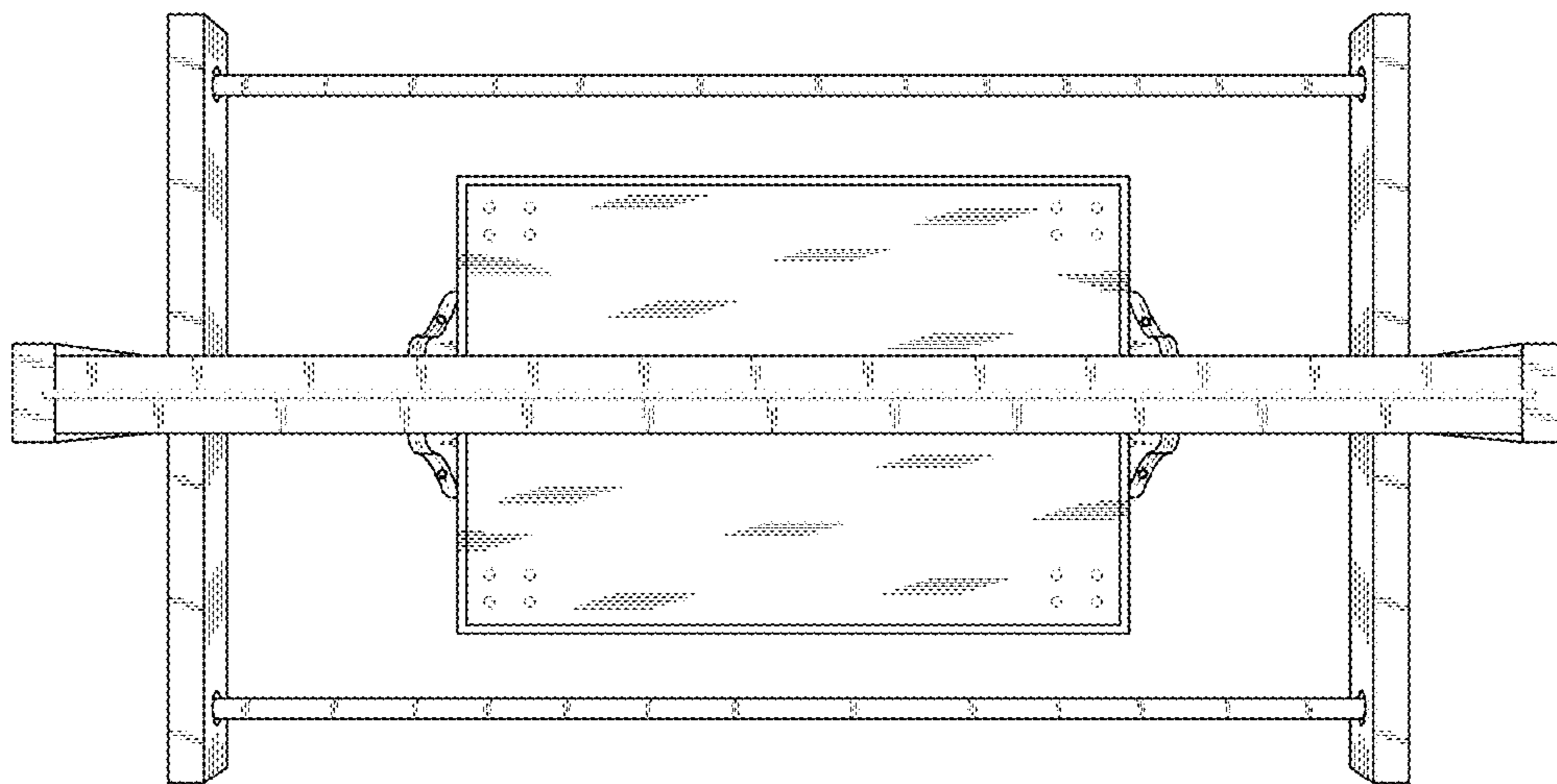

FIG. 6



FIG. 7