



US00D841947S

(12) **United States Design Patent**  
**Grinstead**

(10) **Patent No.:** **US D841,947 S**

(45) **Date of Patent:** **\*\* Mar. 5, 2019**

(54) **SLIPPER**

(71) Applicant: **MerchSource, LLC**, Irvine, CA (US)

(72) Inventor: **Jolene Grinstead**, Walnut, CA (US)

(73) Assignee: **MerchSource, LLC**, Irvine, CA (US)

(\*\*) Term: **15 Years**

(21) Appl. No.: **29/590,716**

(22) Filed: **Jan. 12, 2017**

(51) **LOC (11) Cl.** ..... **02-04**

(52) **U.S. Cl.**  
USPC ..... **D2/919; D2/923**

(58) **Field of Classification Search**  
USPC ..... D2/896-900, 907, 909, 919, 923-925,  
D2/969  
CPC .... A43B 5/00; A43B 3/14; A43B 3/16; A43B  
3/101  
See application file for complete search history.

(56) **References Cited**

**U.S. PATENT DOCUMENTS**

D232,008 S \* 7/1974 Fukuoa ..... D2/923  
D563,634 S \* 3/2008 Della Valle ..... D2/923  
D611,239 S \* 3/2010 Brambilla ..... D2/923

D613,483 S \* 4/2010 Della Valle ..... D2/923  
D662,292 S \* 6/2012 Meynard ..... D2/923  
D697,291 S \* 1/2014 Zaedow ..... D2/923  
D760,484 S \* 7/2016 Del Biondi ..... D2/923  
D786,542 S \* 5/2017 Fu ..... D2/923

**FOREIGN PATENT DOCUMENTS**

CN 201430471572.9 6/2015  
CN 201430471522.0 7/2015

\* cited by examiner

*Primary Examiner* — Rashida C. Walshon

(74) *Attorney, Agent, or Firm* — Avyno Law P.C.

(57) **CLAIM**

I claim the ornamental design for slipper, as shown and described.

**DESCRIPTION**

FIG. 1 is a front perspective view of slipper.  
FIG. 2 is a side view of the right side of the slipper of FIG. 1.  
FIG. 3 is a side view of the left side of the slipper of FIG. 1.  
FIG. 4 is a top view of the slipper of FIG. 1.  
FIG. 5 is a bottom view of the slipper of FIG. 1.  
FIG. 6 is a rear view of the slipper of FIG. 1; and,  
FIG. 7 is a front view of the slipper of FIG. 1.

**1 Claim, 6 Drawing Sheets**

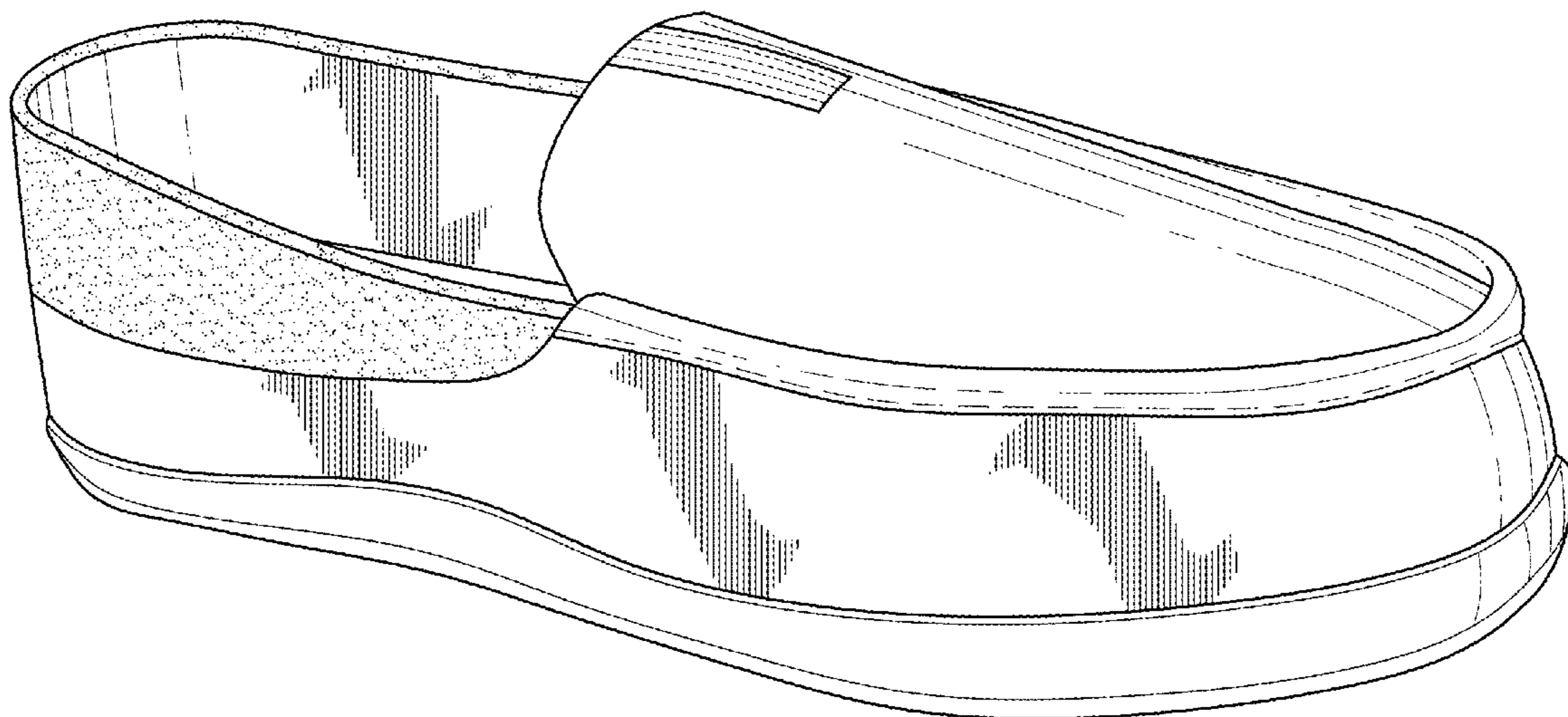

FIG. 1

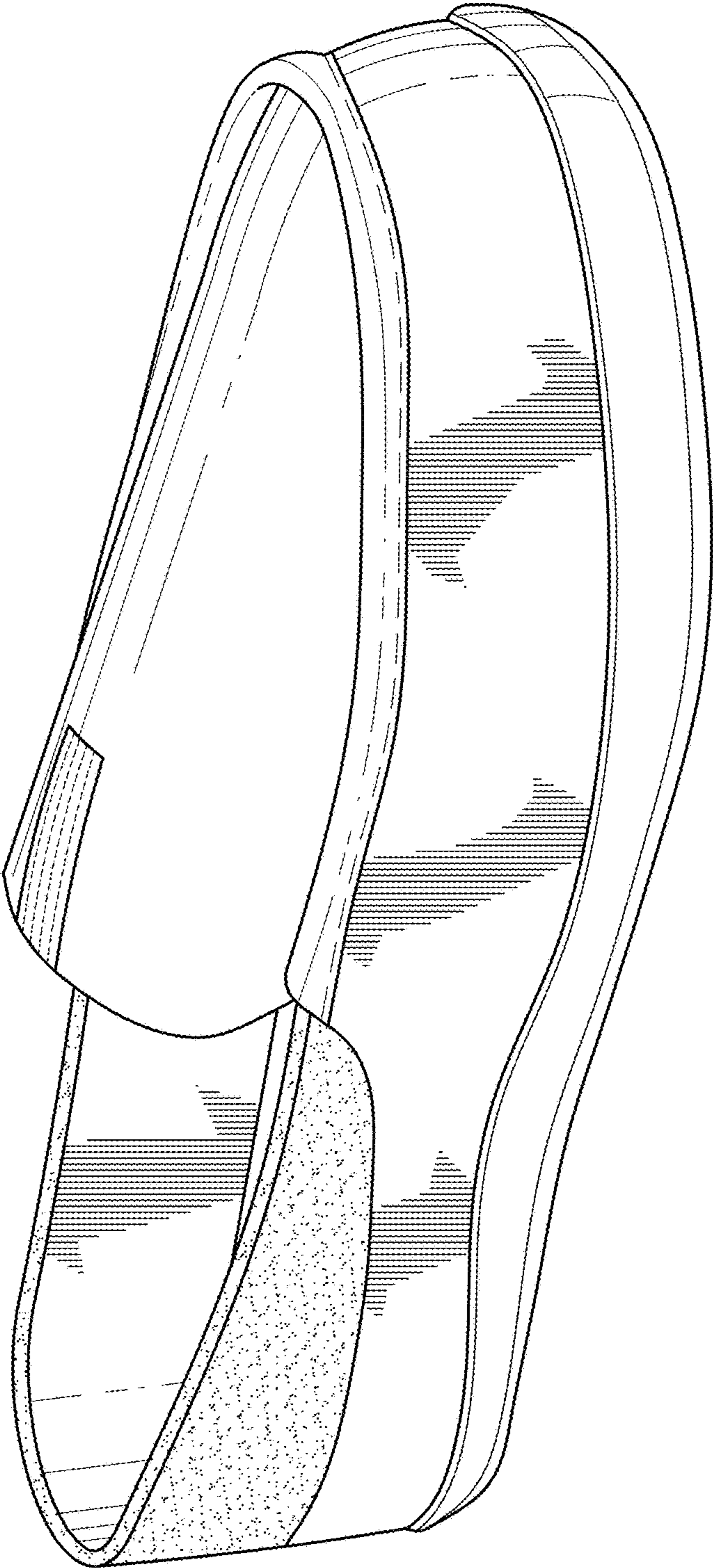
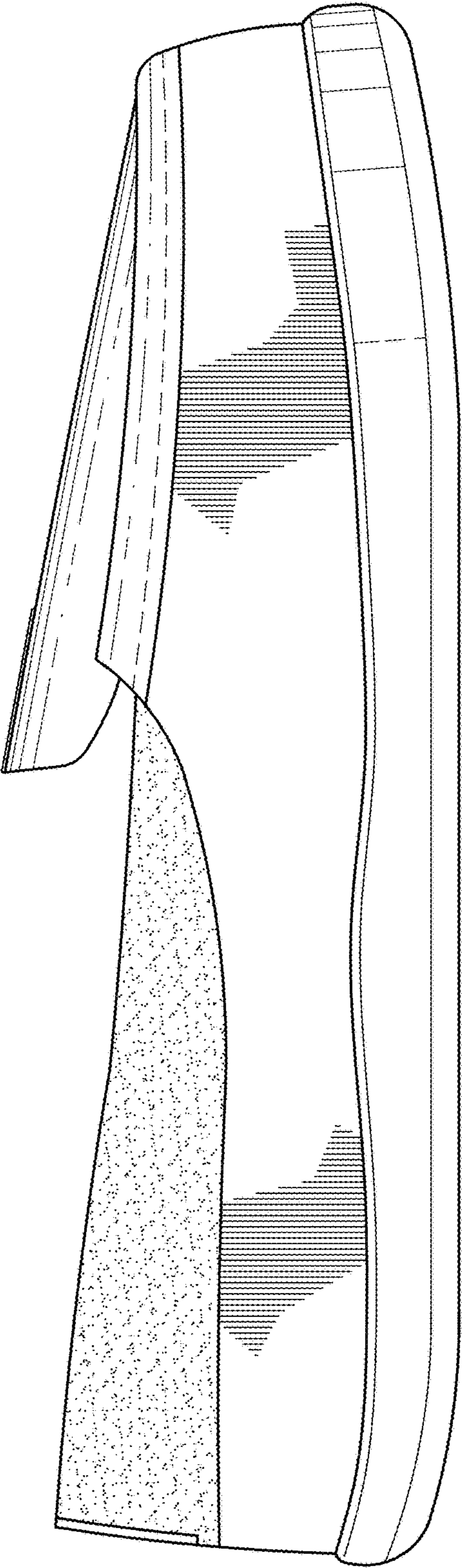

FIG. 2



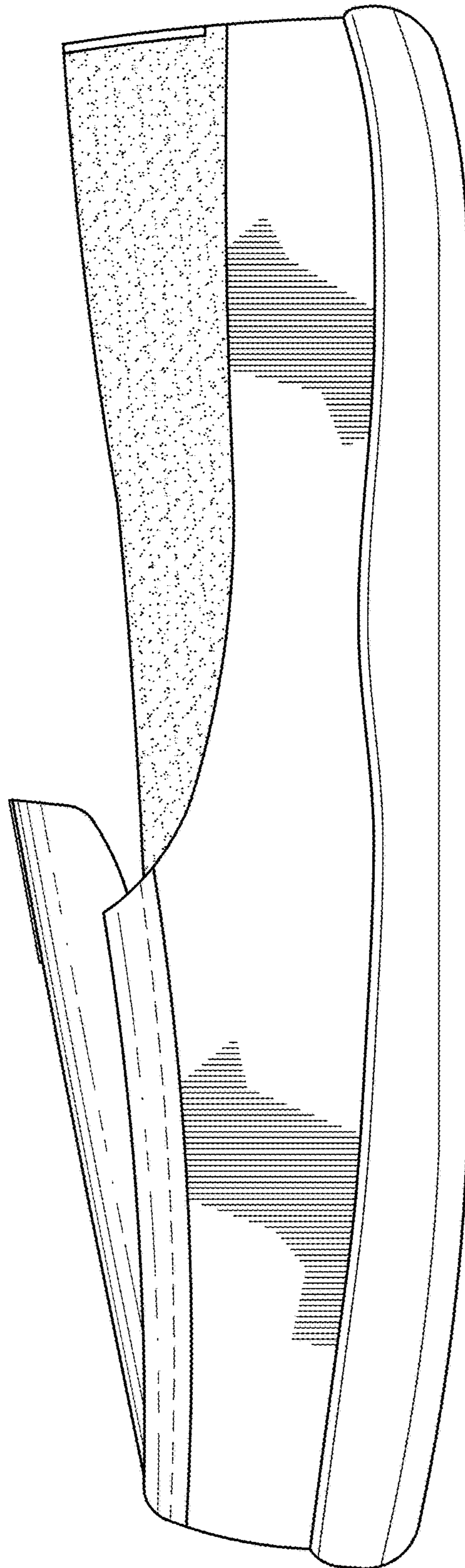

FIG. 3

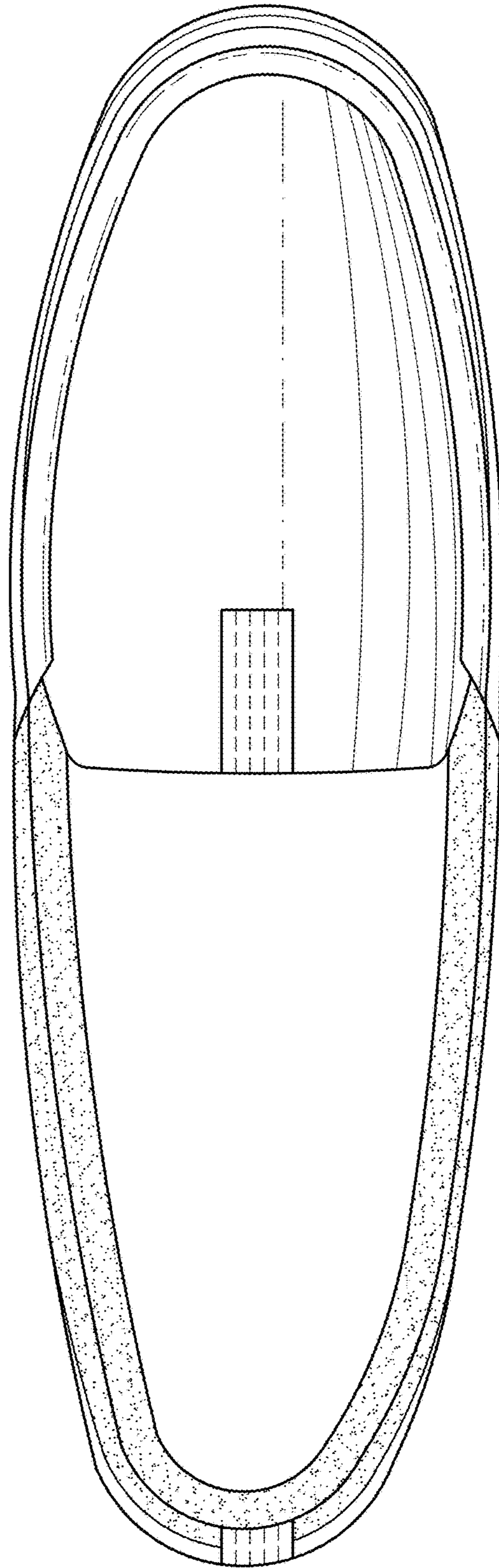

FIG. 4

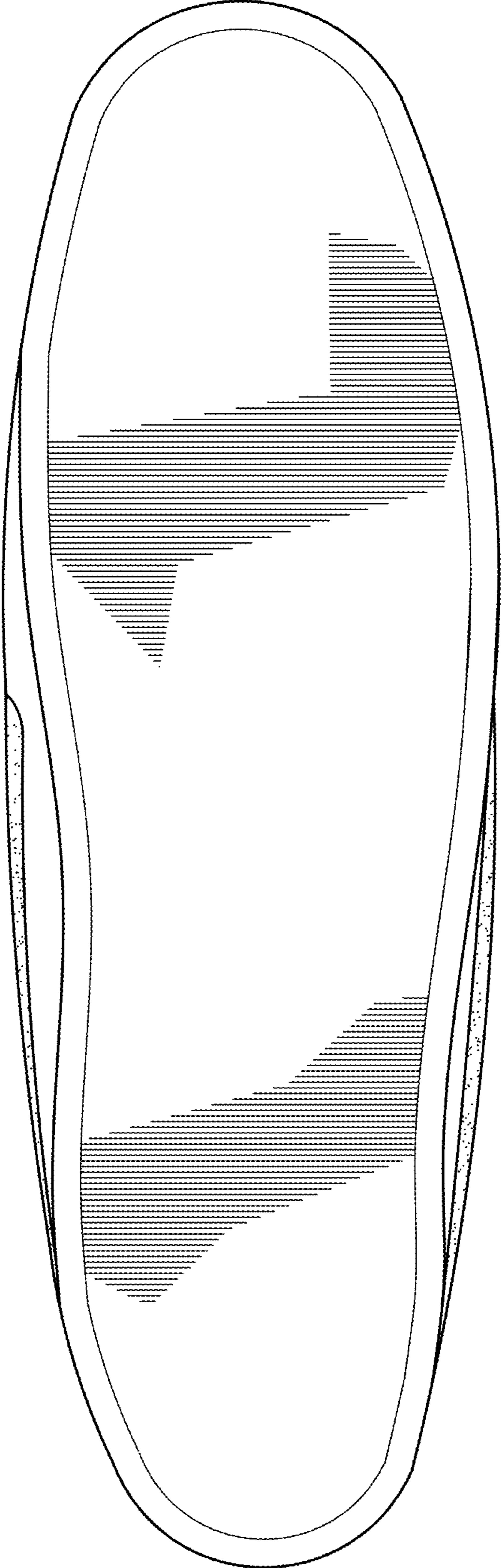

FIG. 5

FIG. 7

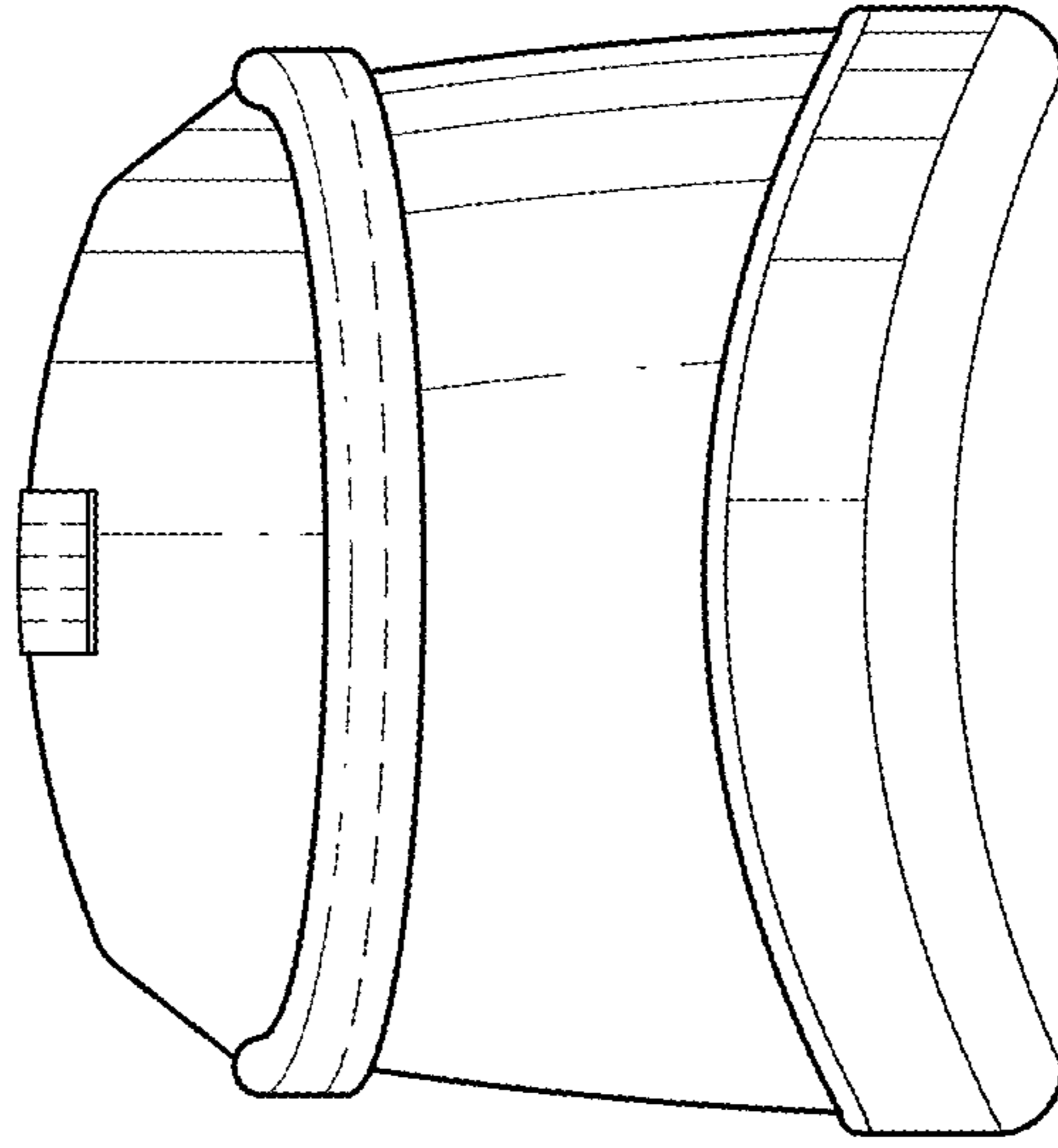

FIG. 6

