



US00D841885S

(12) **United States Design Patent** (10) **Patent No.:** **US D841,885 S**  
**Siu** (45) **Date of Patent:** **\*\* Feb. 26, 2019**

(54) **HEATED BASE FOR HAIR ROLLERS**  
(71) Applicant: **CONAIR CORPORATION**, Stamford, CT (US)  
(72) Inventor: **Man Kit Siu**, Hong Kong (CN)  
(73) Assignee: **Conair Corporation**, Stamford, CT (US)

5,297,567 A \* 3/1994 Summerville ..... A45D 4/16  
132/227  
D362,922 S \* 10/1995 Prince ..... D28/38  
5,692,528 A 12/1997 Brenn-Albertoni  
D392,414 S 3/1998 Smal  
5,771,907 A 6/1998 Dickson  
6,408,858 B1 6/2002 Emmons et al.  
(Continued)

(\*\*) Term: **15 Years**

(21) Appl. No.: **29/629,449**

(22) Filed: **Dec. 13, 2017**

(51) **LOC (11) Cl.** ..... **28-03**

(52) **U.S. Cl.**  
USPC ..... **D28/38**

(58) **Field of Classification Search**  
USPC ..... D28/35, 37-38  
CPC . A45D 2/00; A45D 2/12; A45D 2/125; A45D  
2/14; A45D 2/145; A45D 2/146; A45D  
2/18; A45D 2/20; A45D 2/2464; A45D  
2/2471; A45D 2/36-2/367; A45D  
4/00-4/12; A45D 6/02; A45D 6/04; A45D  
6/0045; A45D 6/16

See application file for complete search history.

(56) **References Cited**

**U.S. PATENT DOCUMENTS**

672,506 A 4/1901 Godward  
1,346,920 A 7/1920 Steinacher  
D217,481 S \* 5/1970 Bernard ..... D21/523  
D226,587 S 3/1973 Keldmann et al.  
D264,637 S \* 5/1982 Barradas ..... D28/38  
4,572,221 A 2/1986 Barradas  
4,584,462 A \* 4/1986 Morrison ..... A45D 4/16  
132/229  
D300,472 S 3/1989 Keung  
4,837,118 A 6/1989 Yamamoto et al.  
D302,598 S 8/1989 Keung  
5,144,968 A 9/1992 Rivera

**OTHER PUBLICATIONS**

Conair Bun-2-Done, www.qvc.com, reviewed Dec. 2017, 1 page.\*  
Clairol Benders, 1987 Clairol product, downloaded Sep. 18, 2018,  
1 page.\*

*Primary Examiner* — Jennifer Rivard

(74) *Attorney, Agent, or Firm* — Lawrence Cruz, Esq.;  
Ryan, Mason & Lewis, LLP

(57) **CLAIM**

The ornamental design for a heated base for hair rollers, as shown and described.

**DESCRIPTION**

FIG. 1 is a perspective view of the heated base for hair rollers in accordance with the principles of the present disclosure;

FIG. 2 is a front side elevation view of the heated base for hair rollers of FIG. 1;

FIG. 3 is a rear side elevation view of the heated base for hair rollers of FIG. 1;

FIG. 4 is a right side elevation view of the heated base for hair rollers of FIG. 1;

FIG. 5 is a left side elevation view of the heated base for hair rollers of FIG. 1;

FIG. 6 is a top plan view of the heated base for hair rollers of FIG. 1; and,

FIG. 7 is a bottom plan view of the heated base for hair rollers of FIG. 1.

The broken lines shown indicate unclaimed portions of the article and form no part of the claimed design.

**1 Claim, 6 Drawing Sheets**

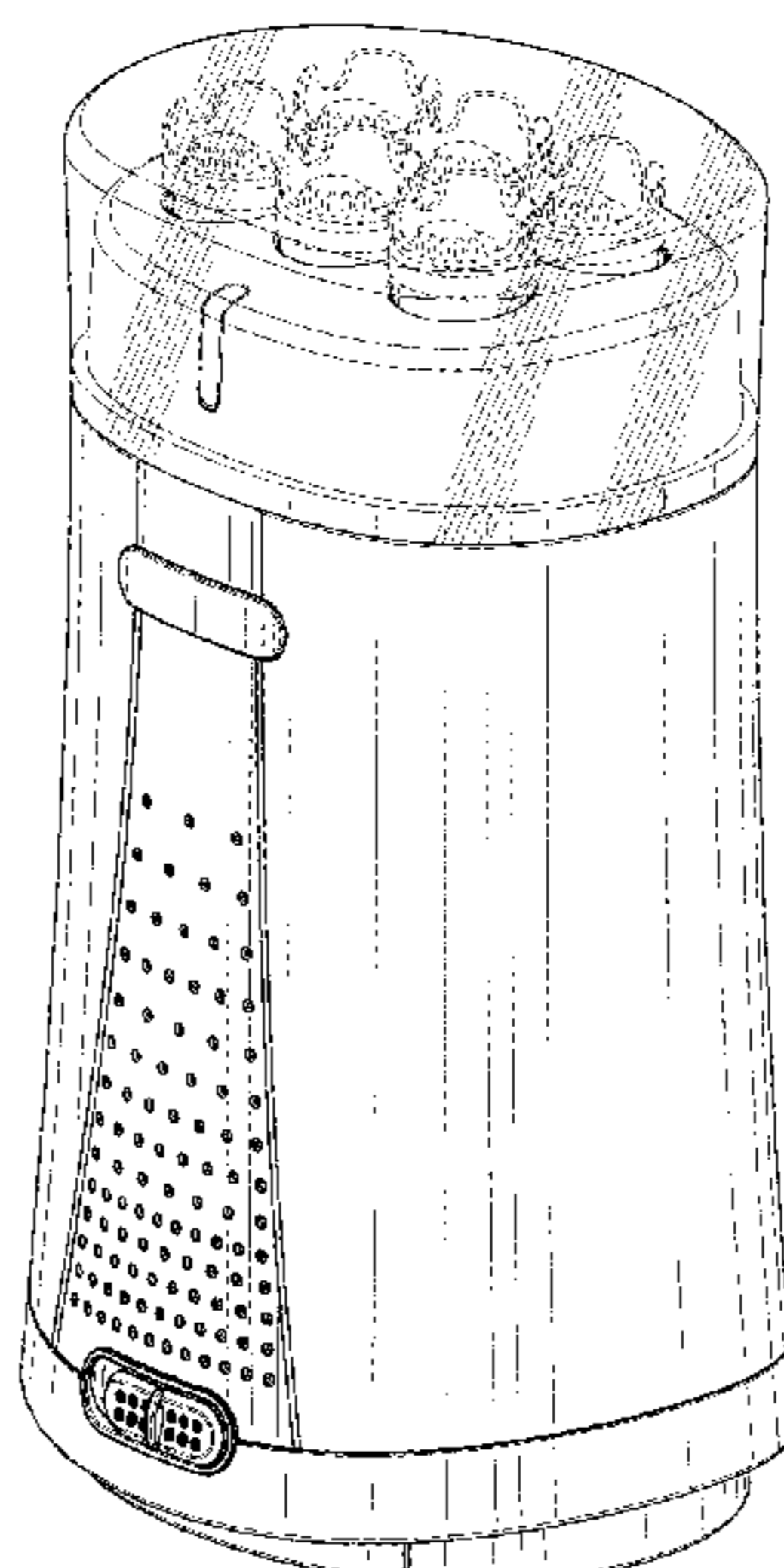

(56)

**References Cited**

U.S. PATENT DOCUMENTS

D467,386	S	12/2002	Carlucci et al.	
D477,689	S	7/2003	Hoffman et al.	
D507,376	S	7/2005	Tobin	
6,978,898	B2	12/2005	Carlucci et al.	
D543,659	S	5/2007	Cheung	
D543,660	S	5/2007	Cheung	
D693,518	S	11/2013	Hsu	
D698,995	S *	2/2014	Xu .....	D28/37
8,912,467	B2	12/2014	Oishi et al.	
D742,068	S	10/2015	Stensby et al.	
D776,872	S	1/2017	Carlucci	
D778,497	S	2/2017	Carlucci	
2004/0118425	A1	6/2004	Santhouse et al.	
2007/0257019	A1	11/2007	Carlucci	
2010/0116286	A1 *	5/2010	O'Rourke .....	A45D 2/122 132/254

\* cited by examiner

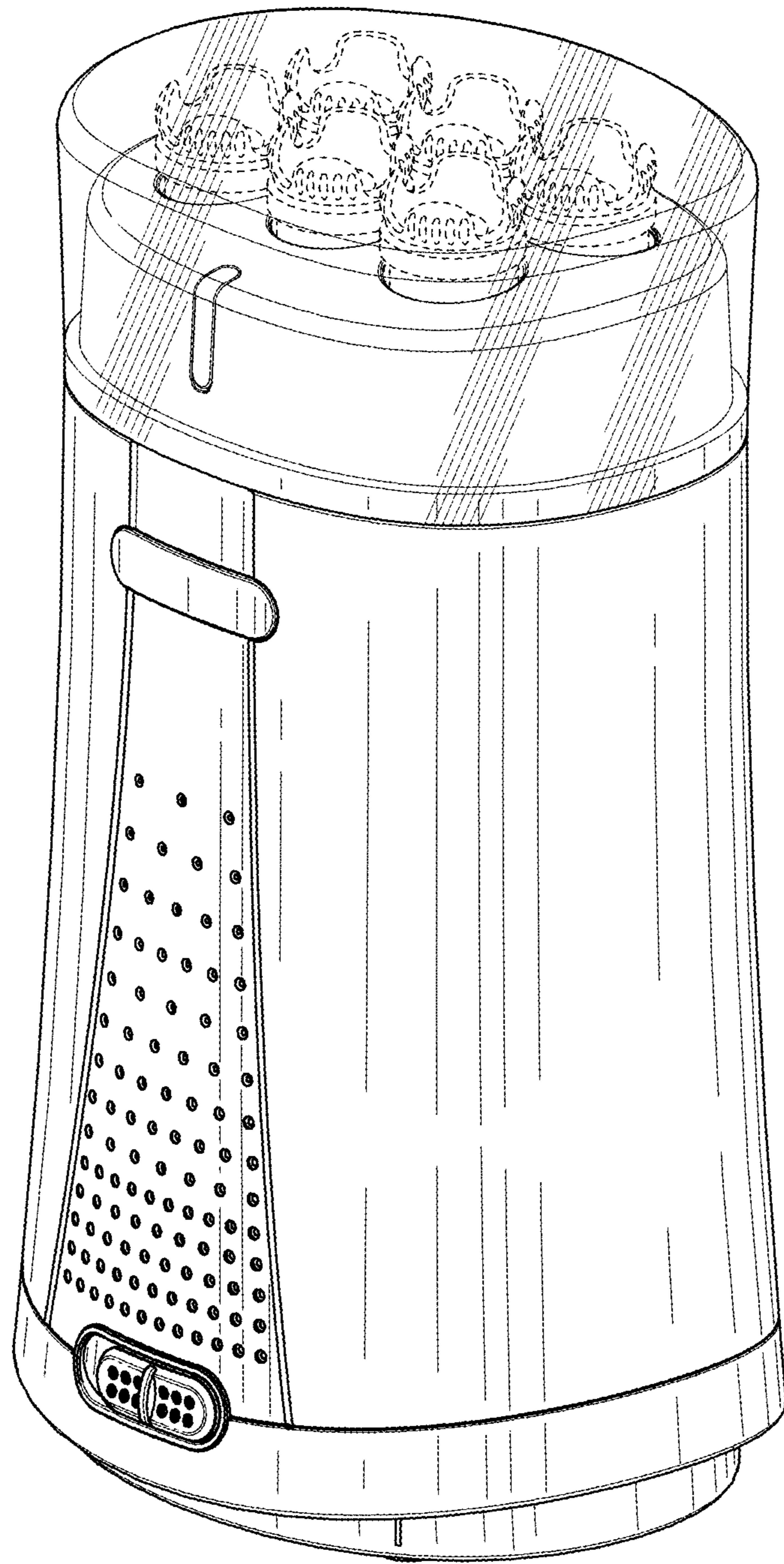

FIG. 1

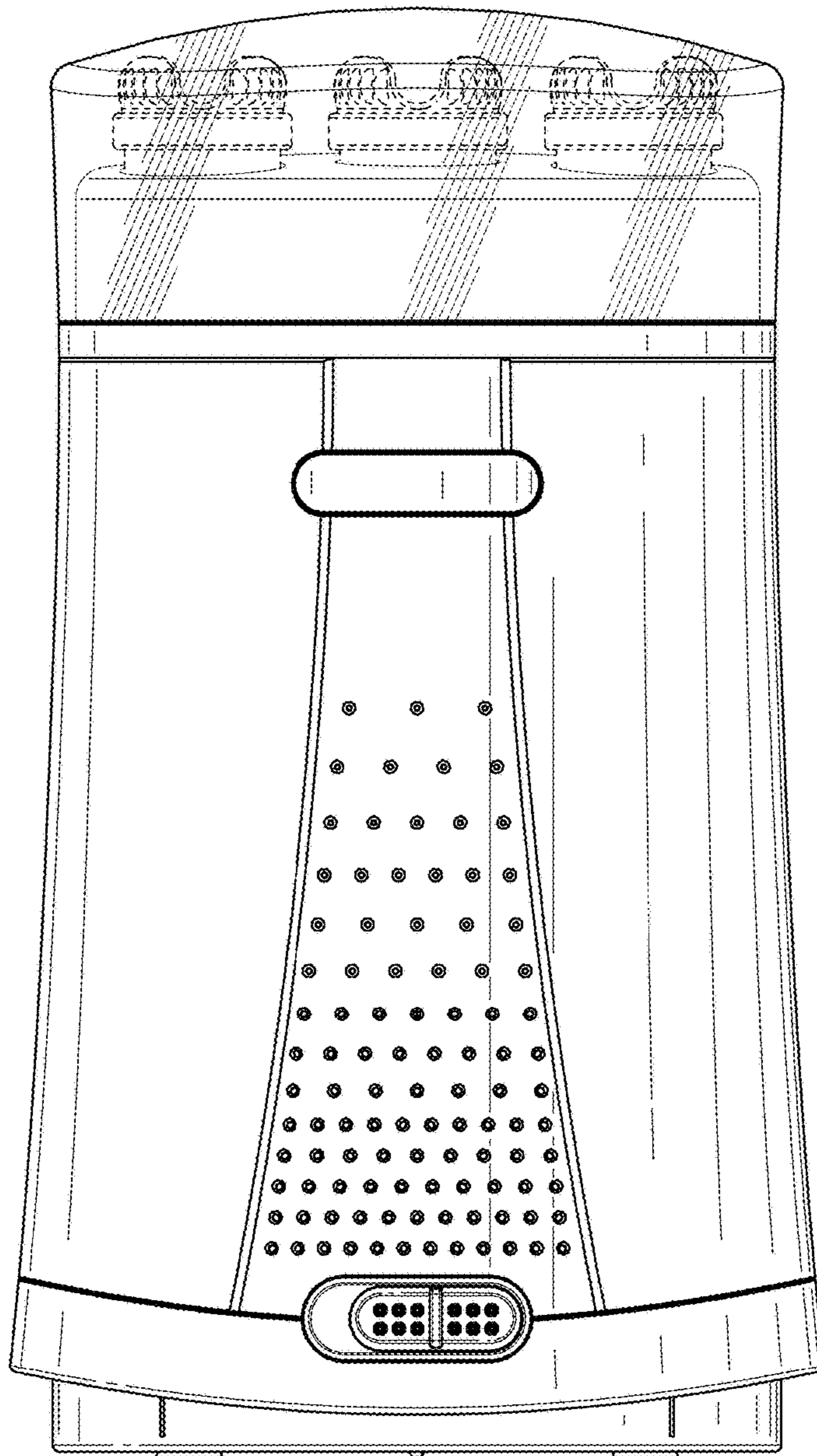

FIG. 2

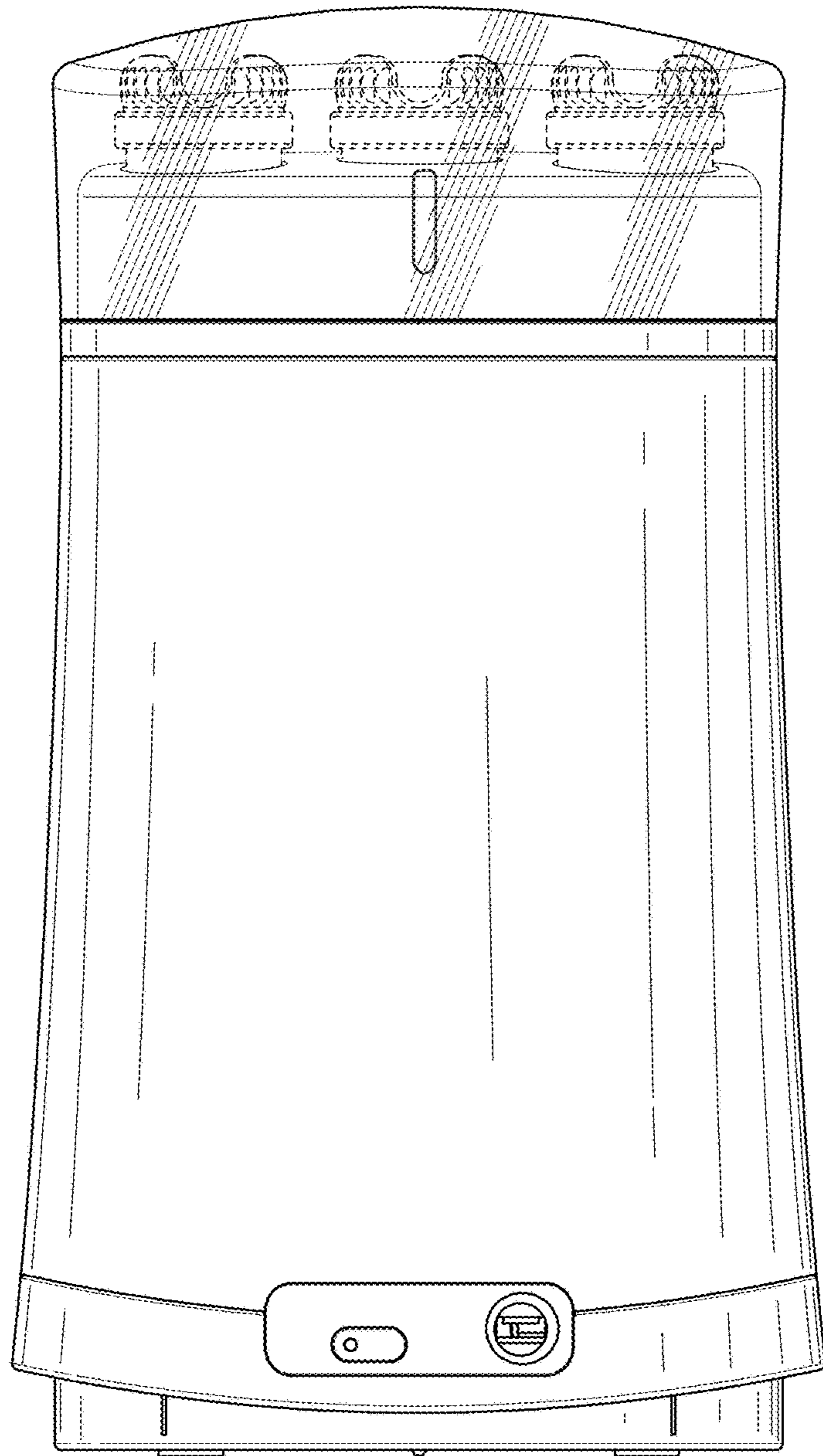

FIG. 3

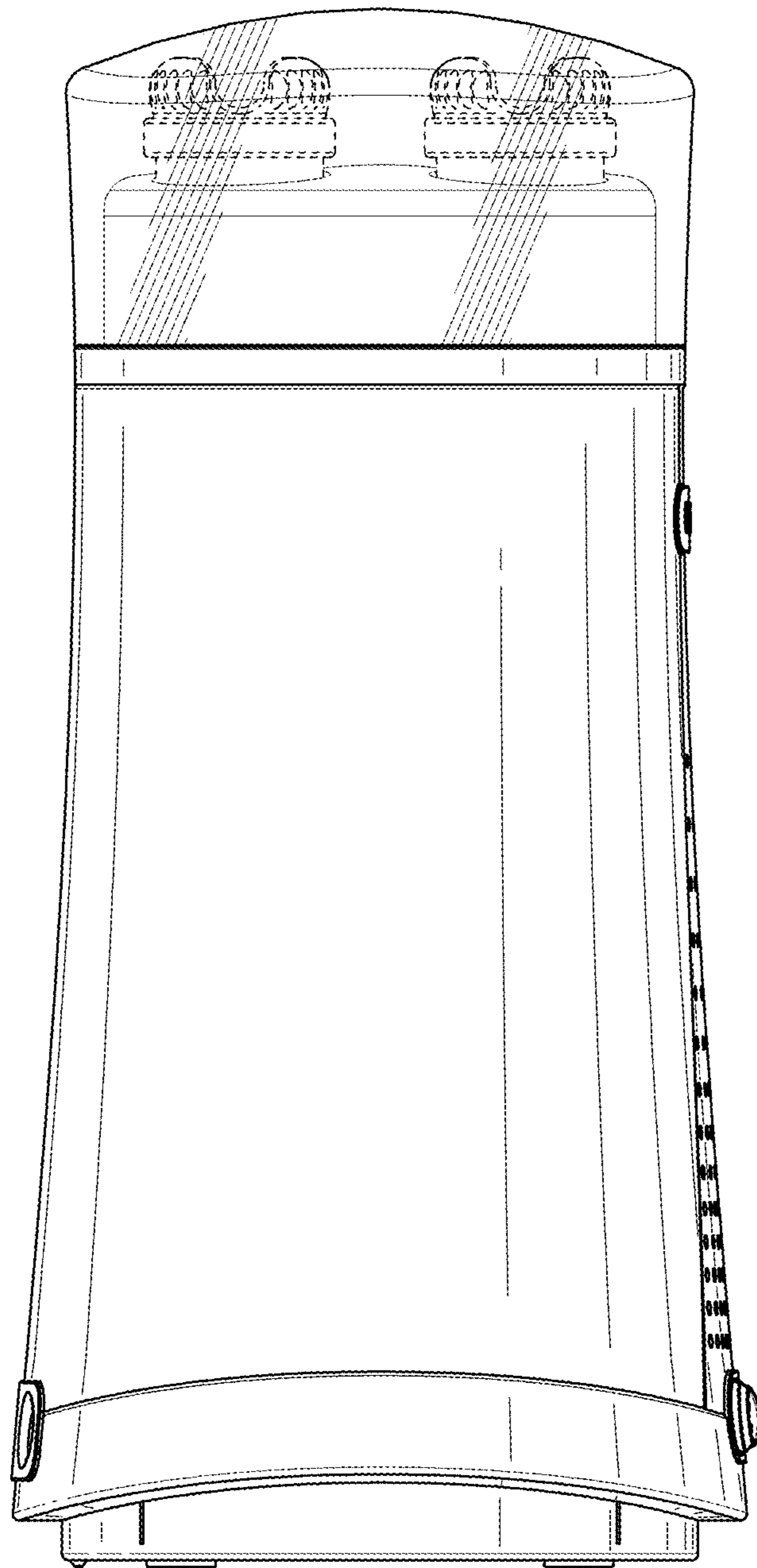

FIG. 4

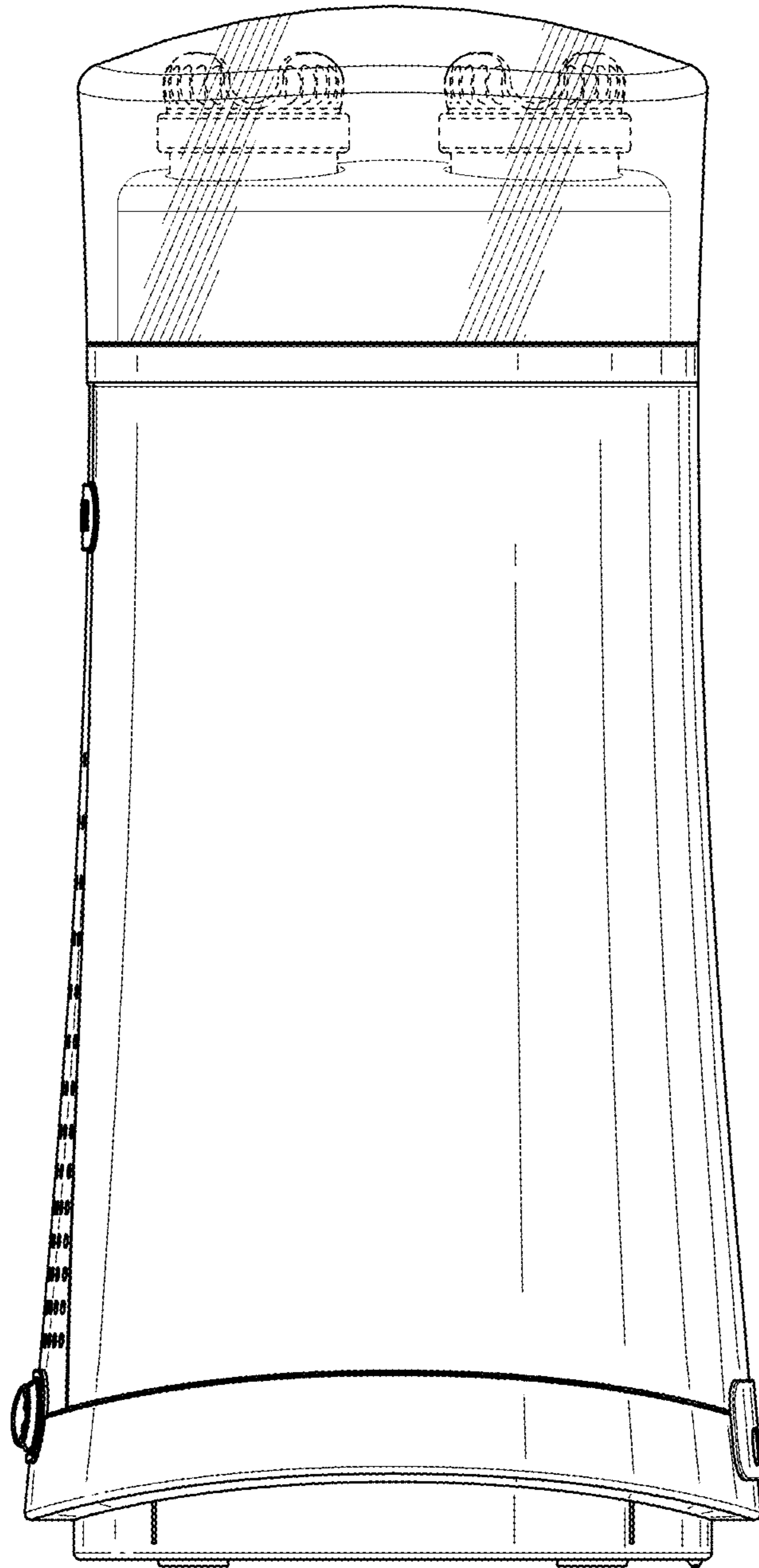

FIG. 5

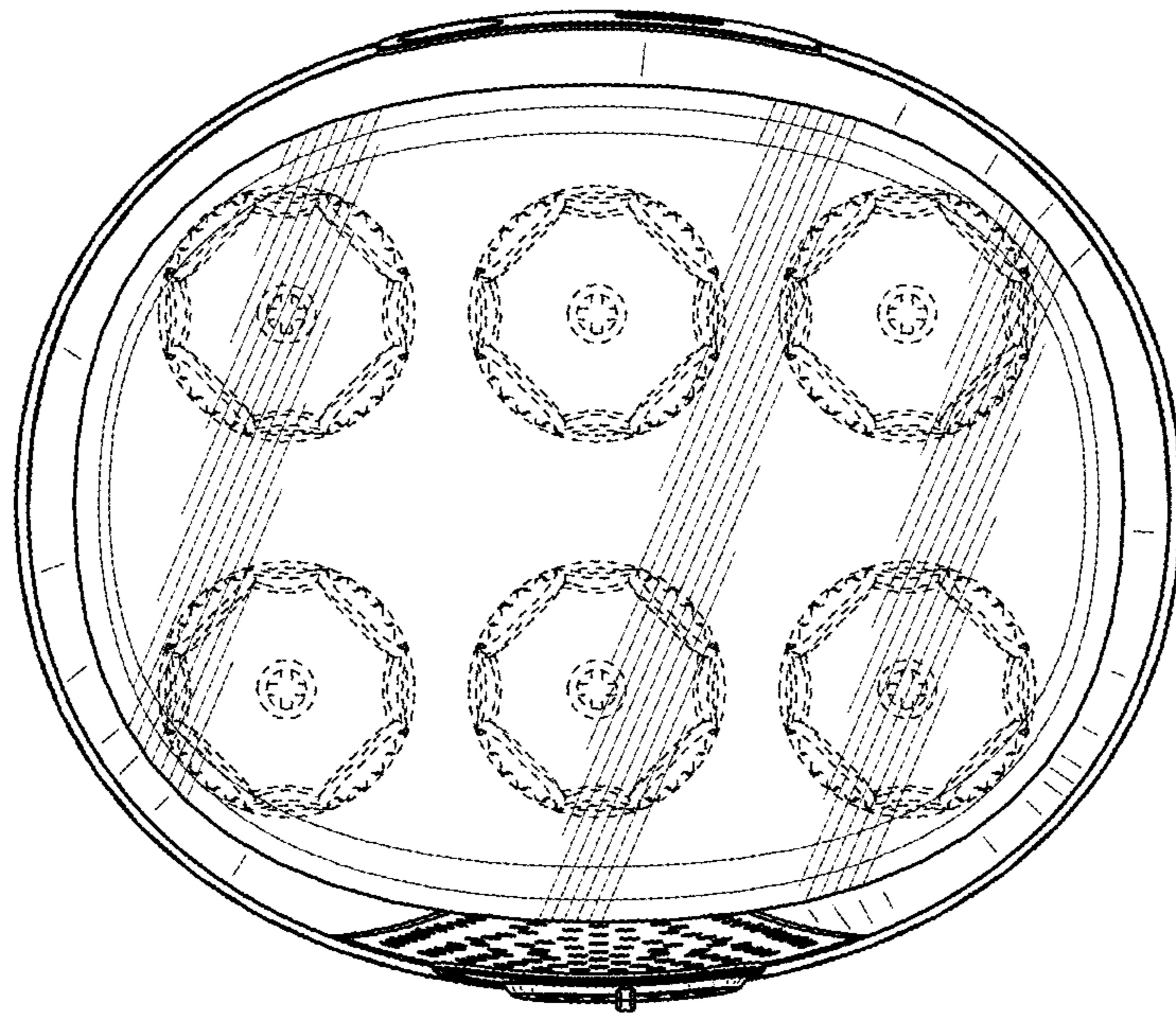

FIG. 6

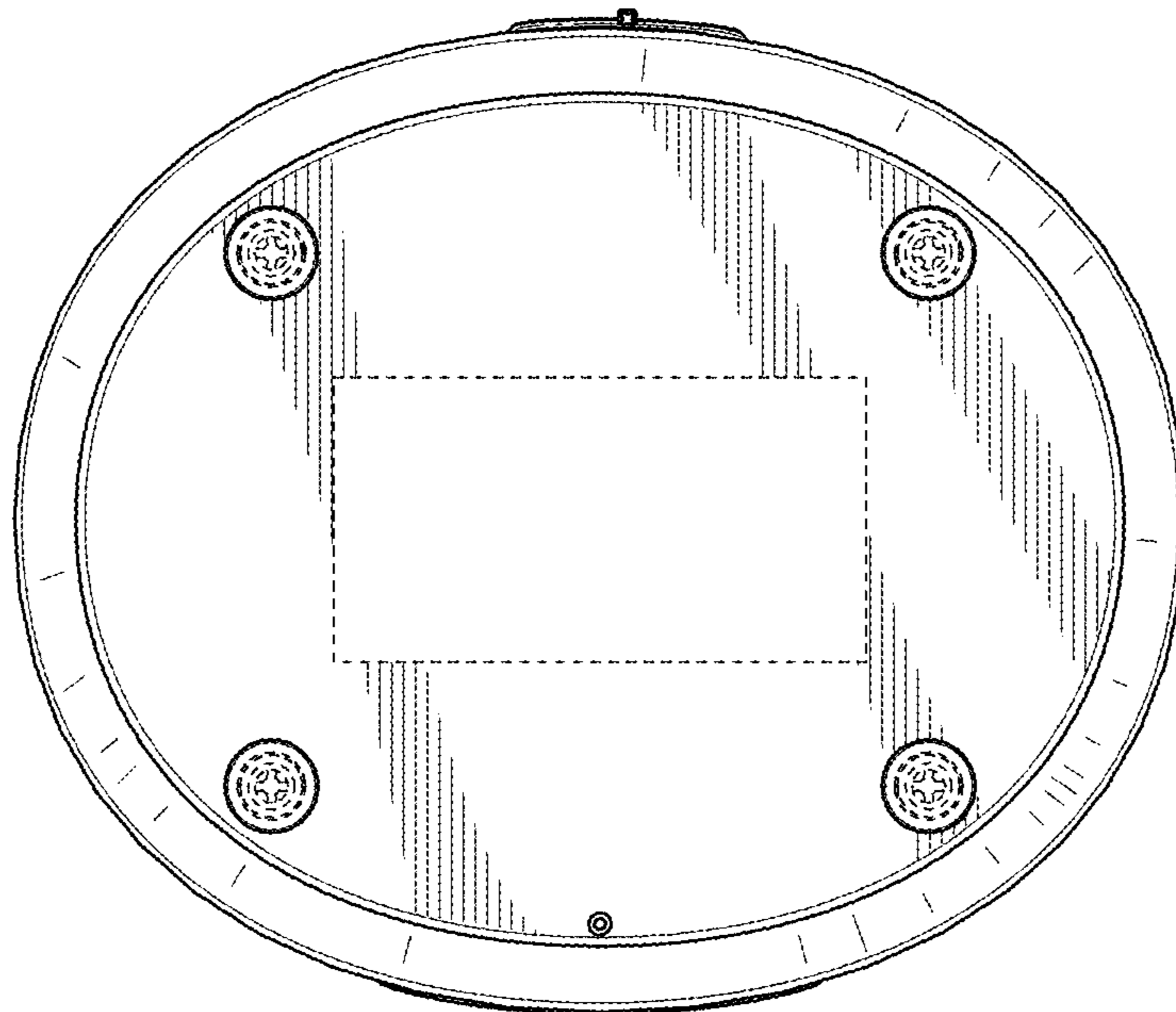

FIG. 7