

US00D841806S

(12) **United States Design Patent** (10) **Patent No.:** **US D841,806 S**
Leather (45) **Date of Patent:** **** Feb. 26, 2019**

(54) **VAGINAL DILATOR**
(71) Applicant: **UNIVERSITY OF CENTRAL LANCASHIRE**, Preston, Lancashire (GB)
(72) Inventor: **Peter Leather**, Preston (GB)
(73) Assignee: **UNIVERSITY OF CENTRAL LANCASHIRE**, Preston, Lancashire (GB)

3,760,808 A 9/1973 Bleuer
D265,342 S 7/1982 Glassman
D269,206 S 5/1983 Glassman
5,501,063 A 3/1996 Tews et al.
5,554,108 A 9/1996 Browning et al.
5,681,340 A 10/1997 Veronikis
5,891,081 A 4/1999 McNelis et al.
6,623,503 B1 9/2003 Thomas et al.
(Continued)

(**) Term: **15 Years**

FOREIGN PATENT DOCUMENTS
CN 303641869 4/2016
WO WO 2016167996 A1 * 10/2016 A61M 29/02

(21) Appl. No.: **29/614,922**
(22) Filed: **Aug. 24, 2017**

OTHER PUBLICATIONS
Monarch Medical Products. <URL: https://www.cmtmedical.com/?main_page=product_info&cPath=124_125_130_133&products_id=550> visited Dec. 22, 2017. Vaginal Dilator set of 7 sizes.*
(Continued)

Related U.S. Application Data

(62) Division of application No. 29/528,416, filed on May 28, 2015, now Pat. No. Des. 798,447.

Foreign Application Priority Data

(30) Dec. 1, 2014 (EM) 002588491-0001
Dec. 1, 2014 (EM) 002588491-0002
Dec. 1, 2014 (EM) 002588491-0003
Dec. 1, 2014 (EM) 002588491-0004

Primary Examiner — Bridget L Eland
Assistant Examiner — Lauren D McVey
(74) *Attorney, Agent, or Firm* — Faegre Baker Daniels LLP

(51) **LOC (11) Cl.** **24-02**
(52) **U.S. Cl.**
USPC **D24/135**
(58) **Field of Classification Search**
USPC D24/135, 141
CPC A61M 29/00; A61B 17/42; A61B 17/0206
See application file for complete search history.

(57) **CLAIM**
I claim the ornamental designs for the vaginal dilator, as shown and described.

(56) **References Cited**
U.S. PATENT DOCUMENTS
2,489,502 A 11/1949 Ruth
2,587,717 A 3/1952 Fourness
2,854,978 A 10/1958 Millman et al.
3,390,671 A 7/1968 Hildebrand

DESCRIPTION
FIG. 1 is a front perspective view of a vaginal dilator, showing my new design;
FIG. 2 is a rear perspective view thereof;
FIG. 3 is a side view thereof, with the opposing side being an identical view thereof;
FIG. 4 is a front view thereof;
FIG. 5 is a rear view thereof;
FIG. 6 is a top view thereof; and,
FIG. 7 is a bottom view thereof.

1 Claim, 5 Drawing Sheets

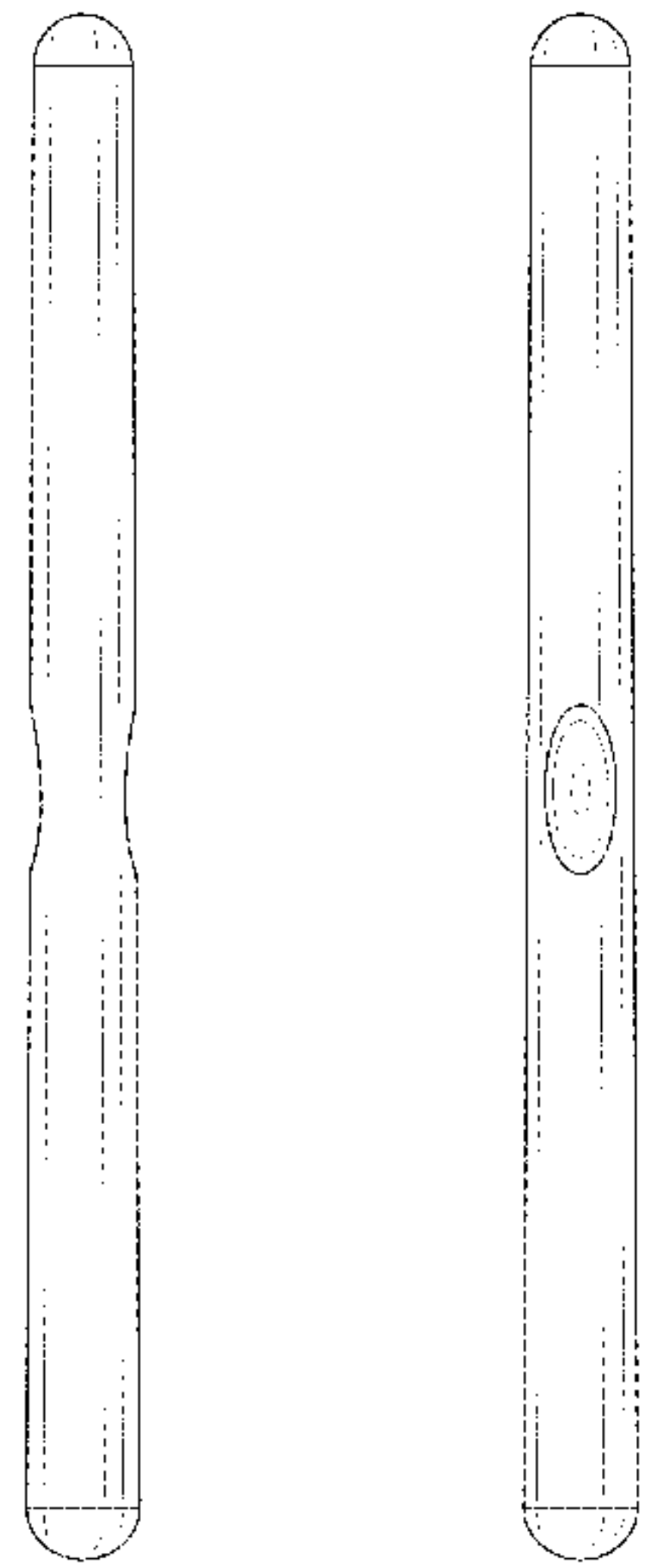

(56)

References Cited

U.S. PATENT DOCUMENTS

6,929,606 B2 8/2005 Ritland
D511,829 S 11/2005 Phipps et al.
D546,451 S 7/2007 Givens, Jr.
D609,807 S 2/2010 Hashimoto
D633,560 S * 3/2011 Clivio D19/167
8,066,730 B2 11/2011 Dorman
D695,449 S 12/2013 Tucker et al.
D725,822 S 3/2015 Liu
D755,440 S 5/2016 Collen
D762,001 S 7/2016 Liu
D763,438 S 8/2016 Gouret
D773,727 S * 12/2016 Eksouzian D27/101
D787,671 S * 5/2017 Orr D24/133
D798,447 S * 9/2017 Leather D24/135
D806,244 S * 12/2017 Rezac D24/133
2002/0143287 A1 10/2002 Buzot
2002/0183681 A1 12/2002 Bernard
2010/0082057 A1 4/2010 Borkon

OTHER PUBLICATIONS

MedGyn Product Catalog, <http://pdf.medicaexpo.com/pdf/medgyn-products/medgyn-catalog/69237-127744.html#search-en-dilato>, available as least as early as Dec. 4, 2014, 64 pages.

Hegar Dilator, Monarch Medical Products, https://www.monarchmedicalproducts.ccm/index.php?route=product/product&path=97_59&product_id=482, available at least as early as Jul. 16, 2012, 3 pages.

* cited by examiner

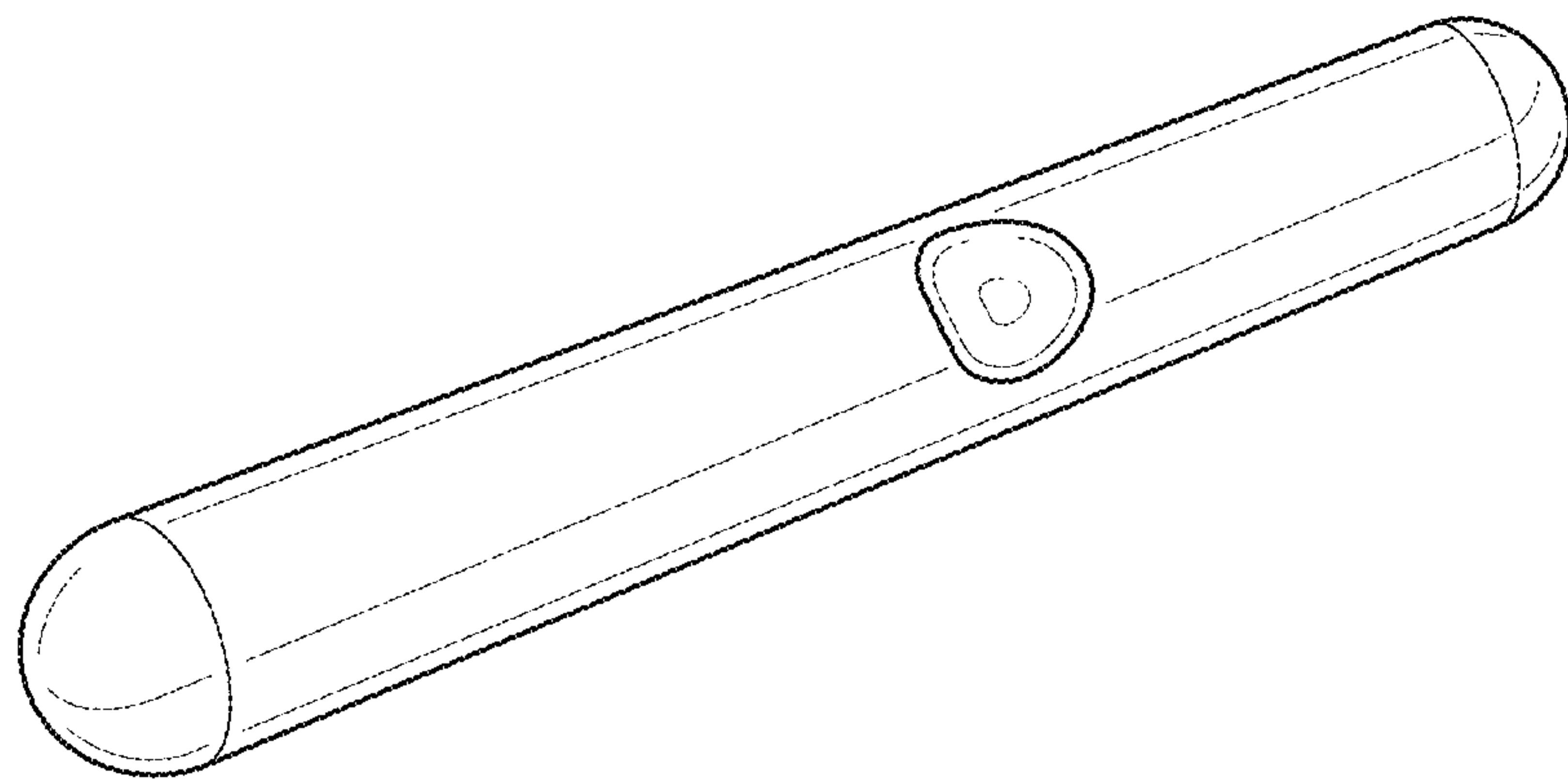

FIG. 1

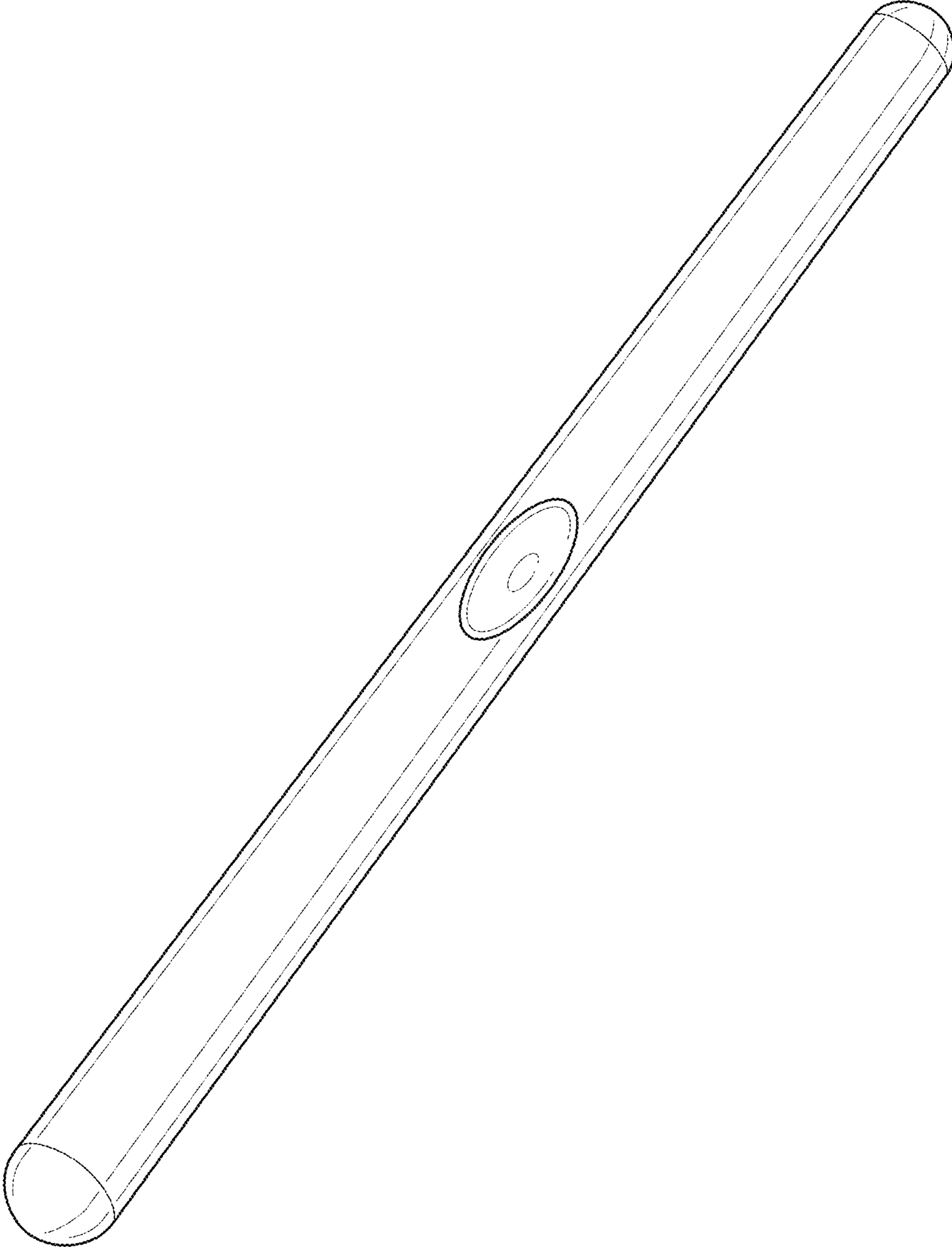

FIG. 2

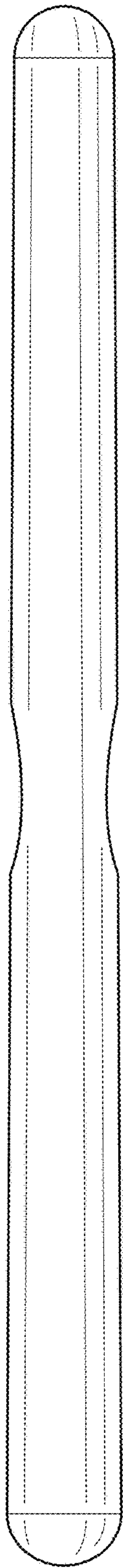

FIG. 3

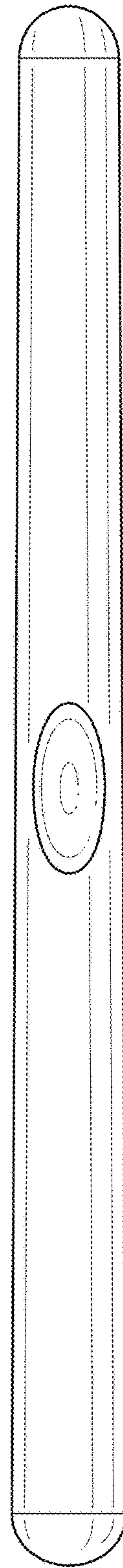

FIG. 4

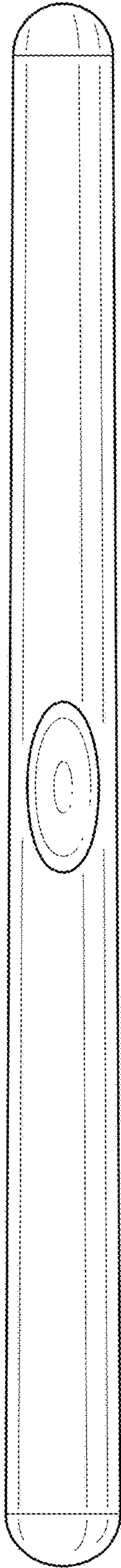

FIG. 5

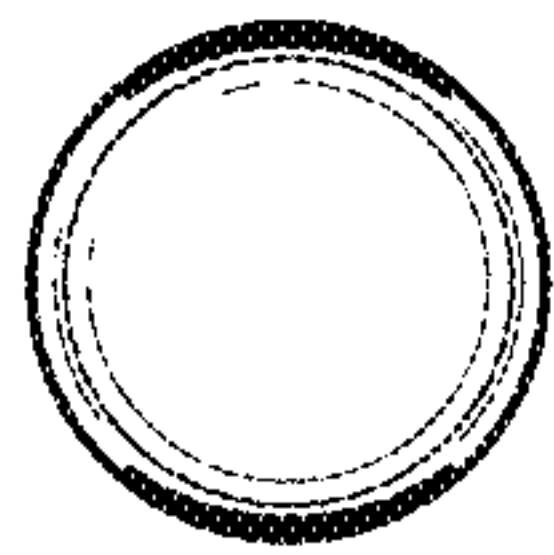

FIG. 6

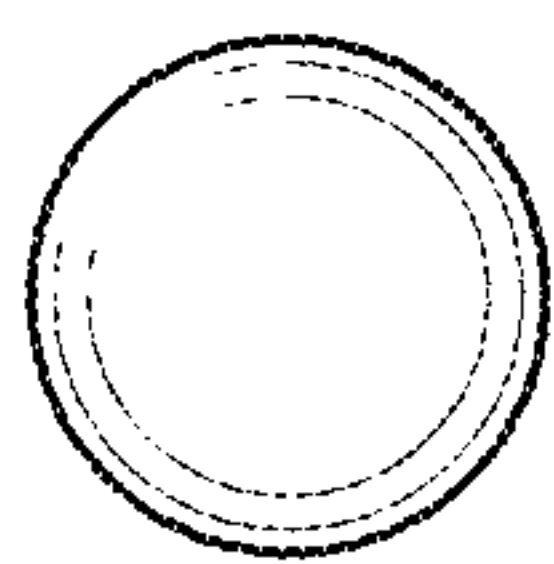

FIG. 7