



US00D841585S

(12) **United States Design Patent**
Huang

(10) **Patent No.:** **US D841,585 S**

(45) **Date of Patent:** **** Feb. 26, 2019**

- (54) **WATERPROOF BATTERY CASE**
- (71) Applicant: **Xiaoxia Huang**, Guangdong (CN)
- (72) Inventor: **Xiaoxia Huang**, Guangdong (CN)
- (**) Term: **15 Years**
- (21) Appl. No.: **29/616,550**
- (22) Filed: **Sep. 7, 2017**
- (51) **LOC (11) Cl.** **13-02**
- (52) **U.S. Cl.**
USPC **D13/119**
- (58) **Field of Classification Search**
USPC D13/102-108, 110, 118, 119, 184, 199;
D14/250; D8/61; D9/772, 422, 428
CPC Y02E 60/12; Y02E 60/122; Y02E 60/124;
Y02E 60/50; H01M 2/02; H01M 2/022;
H01M 2/0202; H01M 2/0207; H01M
2/0212; H01M 2/1061; H01M 2/1022;
H01M 2/1055; H01M 2/1066; H01M
2/105; H01M 2/204; H01M 10/4257;
H01M 10/0436; H01M 10/48
See application file for complete search history.

(56) **References Cited**

U.S. PATENT DOCUMENTS

D573,794 S	*	7/2008	Izen	D3/302
D680,063 S	*	4/2013	Sasada	D13/103
D722,204 S	*	2/2015	Parker	D28/82
D723,274 S	*	3/2015	Almanaseer	D3/264
D746,514 S	*	12/2015	Lambridis	A45D 33/003 D28/4

D767,986 S	*	10/2016	Epstein	D3/289
D811,740 S	*	3/2018	Harrison	D3/264
D816,994 S	*	5/2018	Fischer	D3/294
D820,593 S	*	6/2018	Harrison	D3/264
D822,507 S	*	7/2018	Vivone	D10/30
D829,381 S	*	9/2018	Kim	D28/93

* cited by examiner

Primary Examiner — Rosemary K Tarcza

Assistant Examiner — Christy M Nemeth

(74) *Attorney, Agent, or Firm* — Li & Cai Intellectual Property (USA) Office

(57) **CLAIM**

The ornamental design for a waterproof battery case, as shown and described.

DESCRIPTION

FIG. 1 is a top perspective view of a waterproof battery case showing my new design;
 FIG. 2 is a front view thereof;
 FIG. 3 is a rear view thereof;
 FIG. 4 is a left side view thereof;
 FIG. 5 is a right side view thereof;
 FIG. 6 is a top view thereof;
 FIG. 7 is a bottom view thereof;
 FIG. 8 is a bottom perspective view thereof; and,
 FIG. 9 is an exploded perspective view, showing the waterproof battery case in a disassembled state.
 The broken lines in the drawings are for the purpose of illustrating portions of the waterproof battery case that form no part of the claimed design.

1 Claim, 7 Drawing Sheets

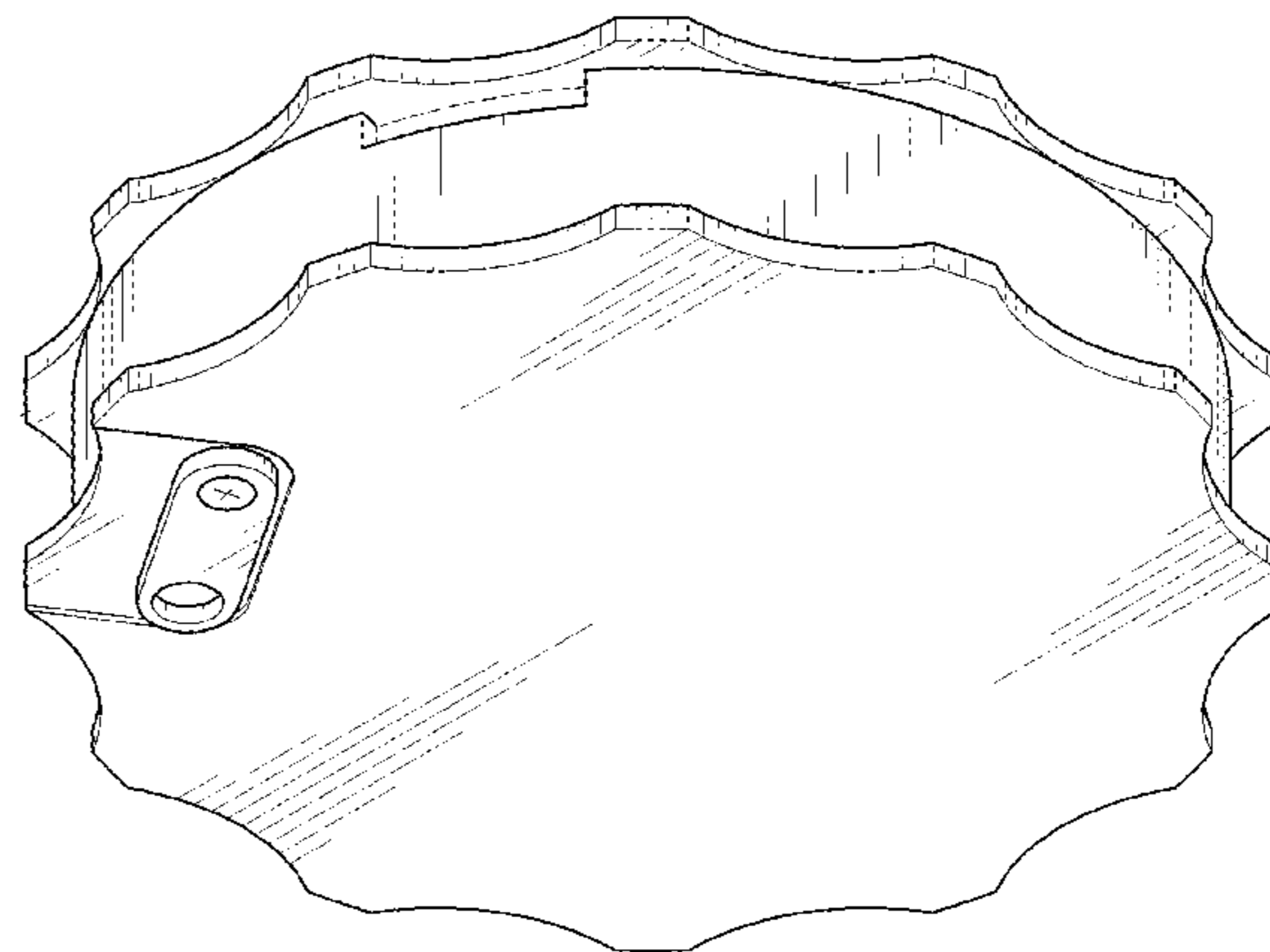
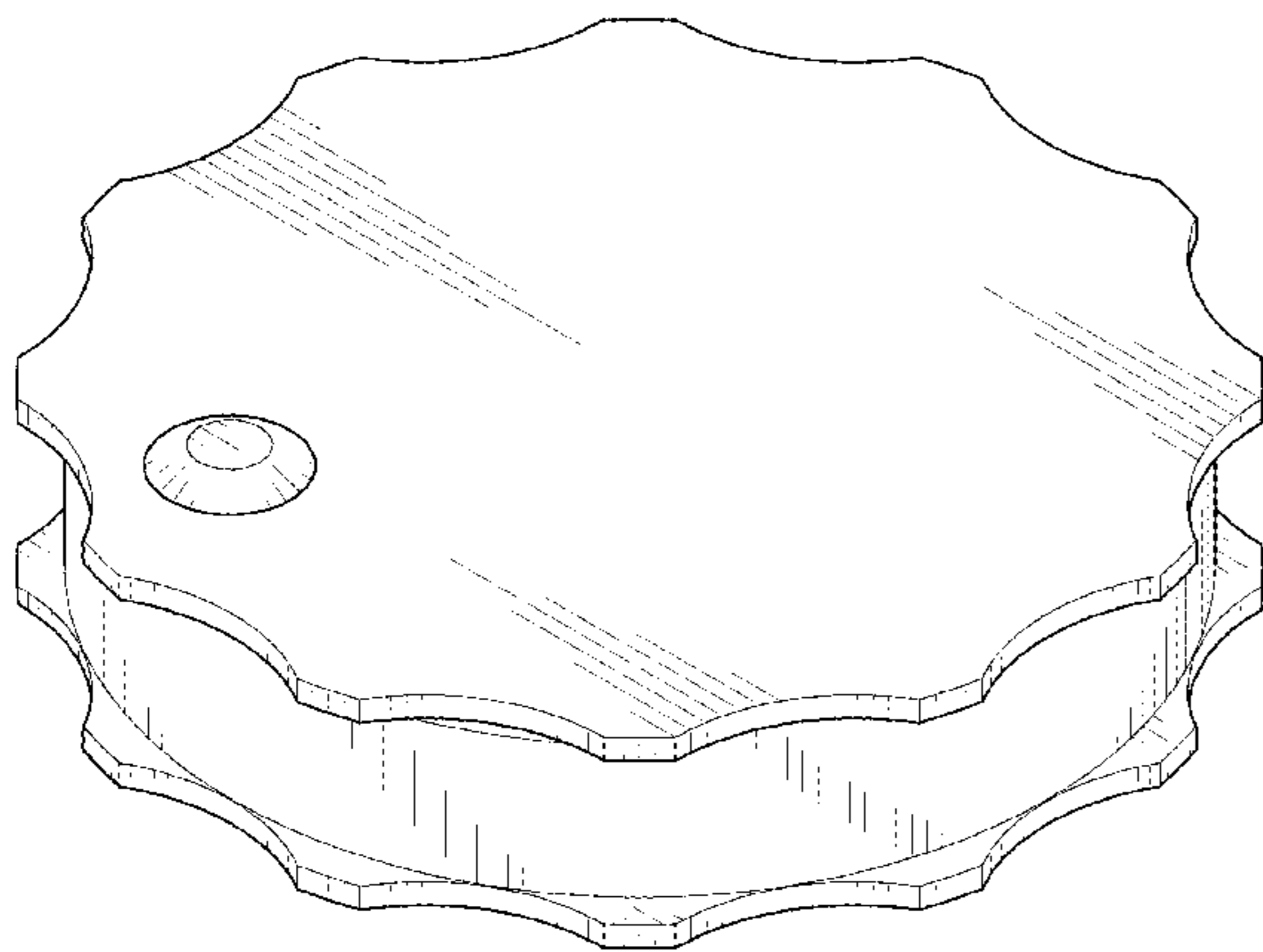

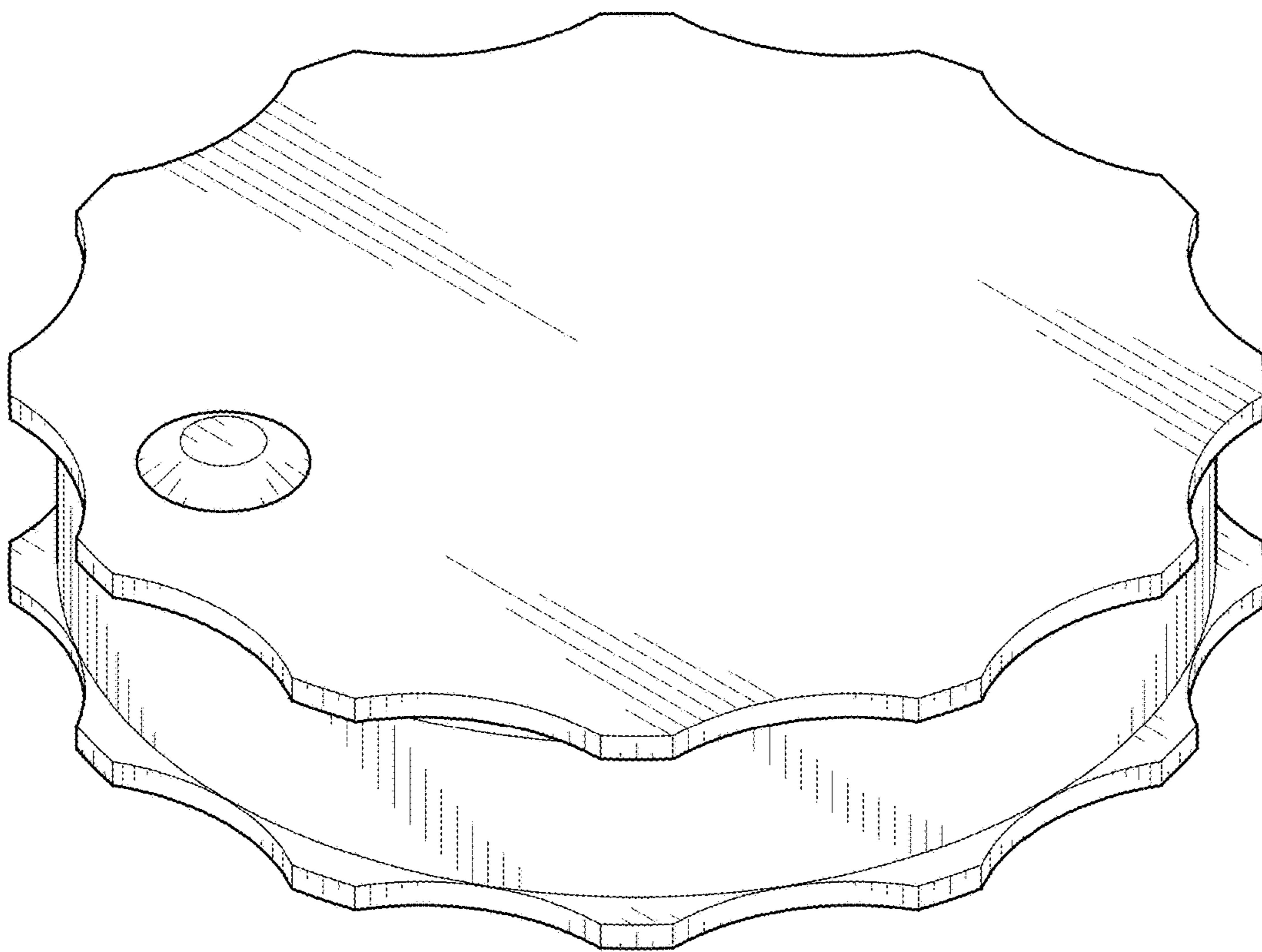

FIG. 1

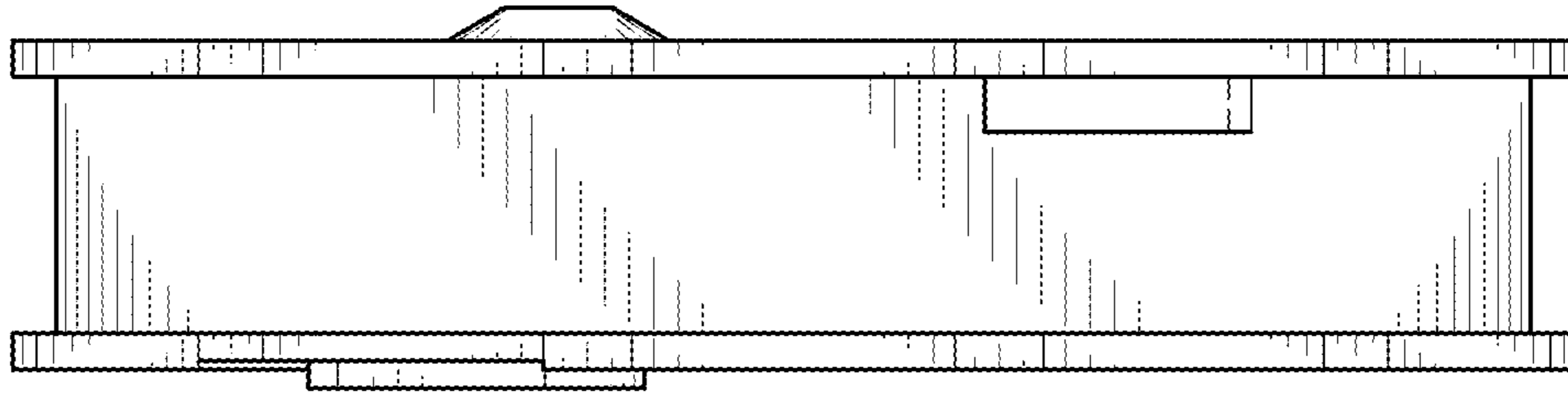

FIG. 2

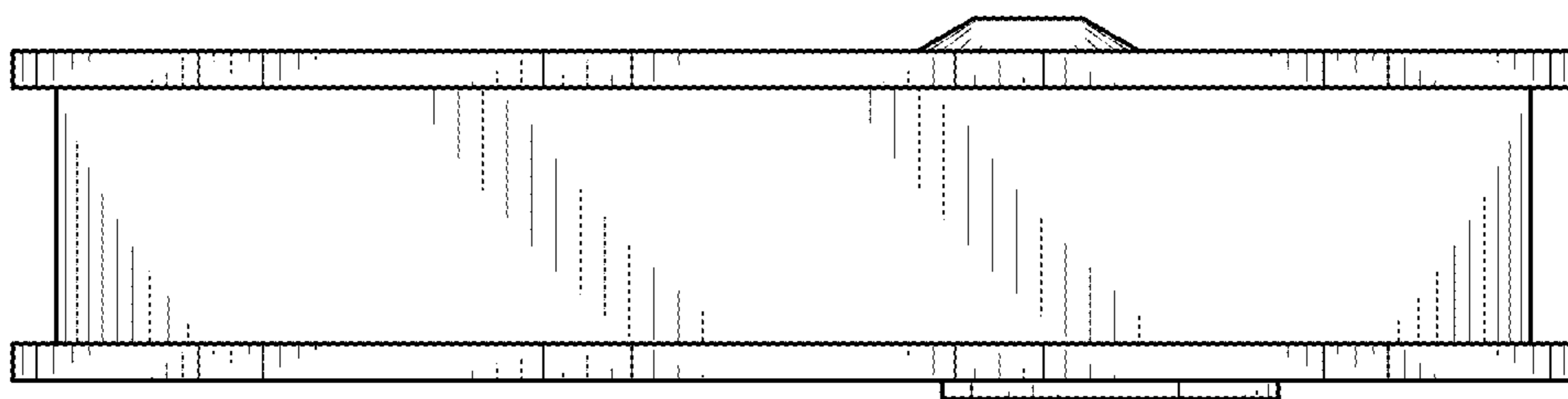

FIG. 3

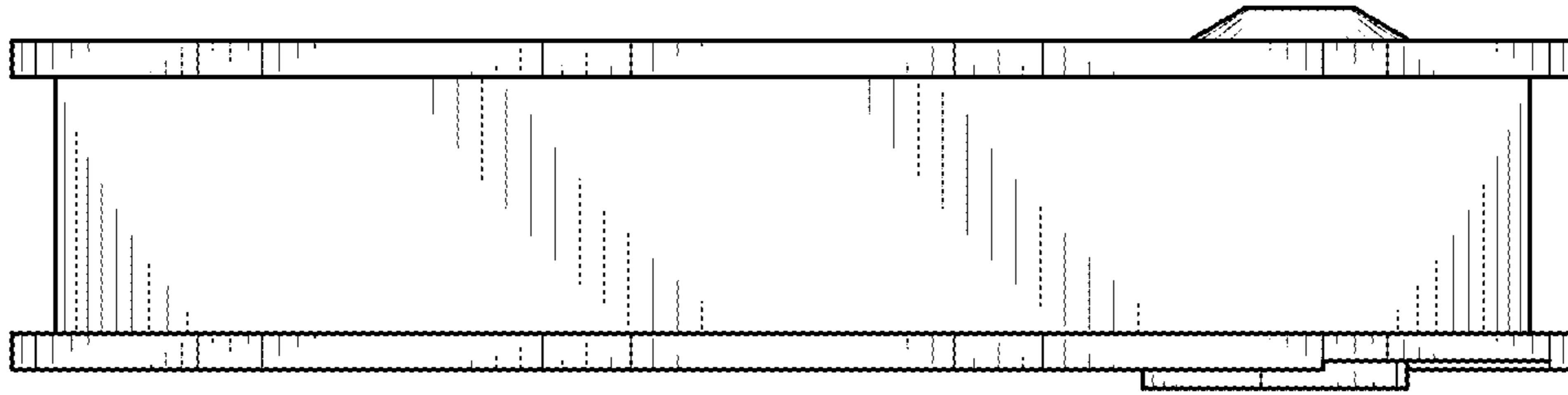

FIG. 4

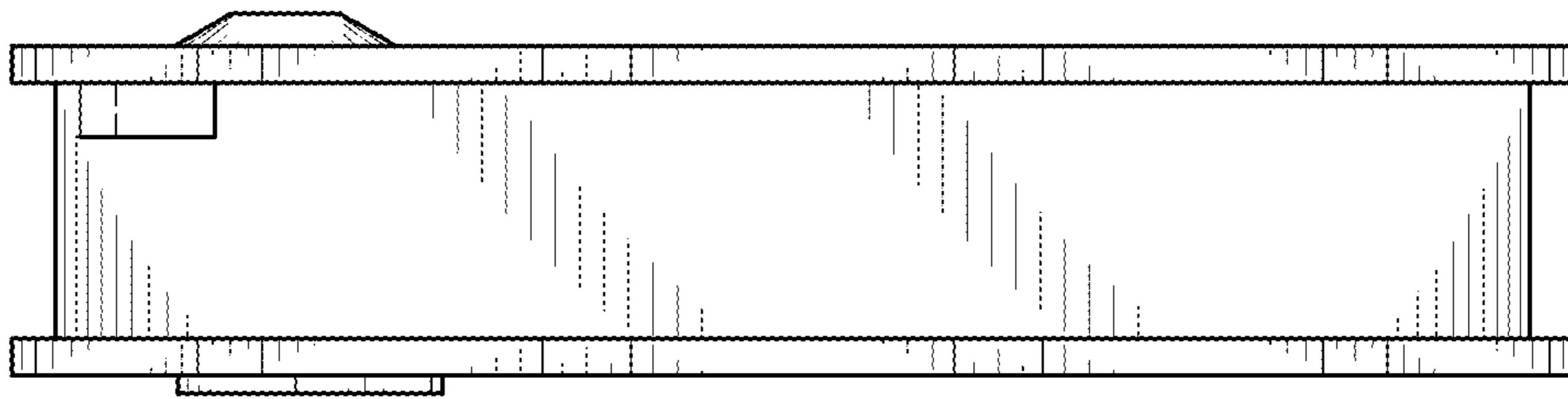

FIG. 5

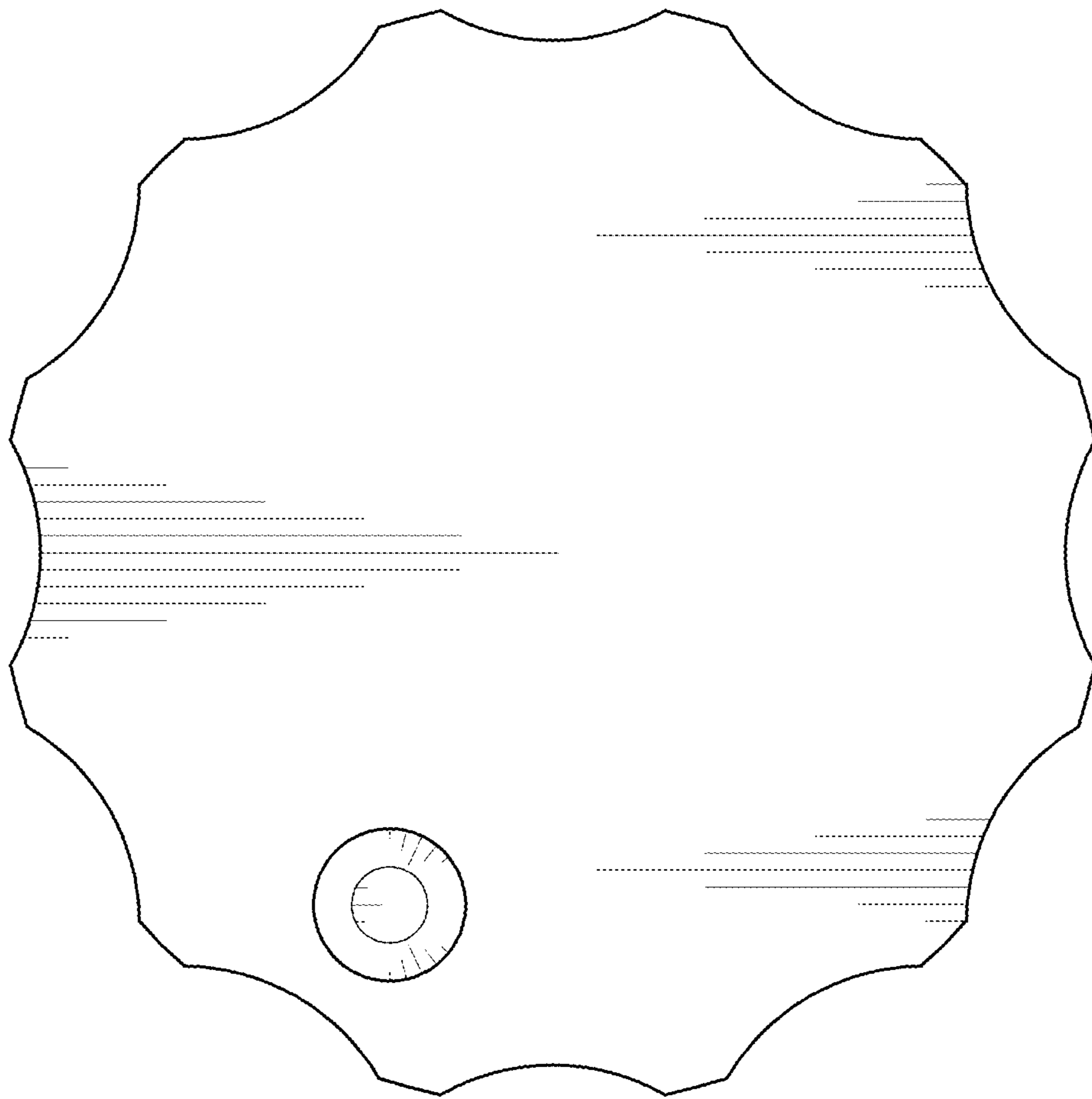

FIG. 6

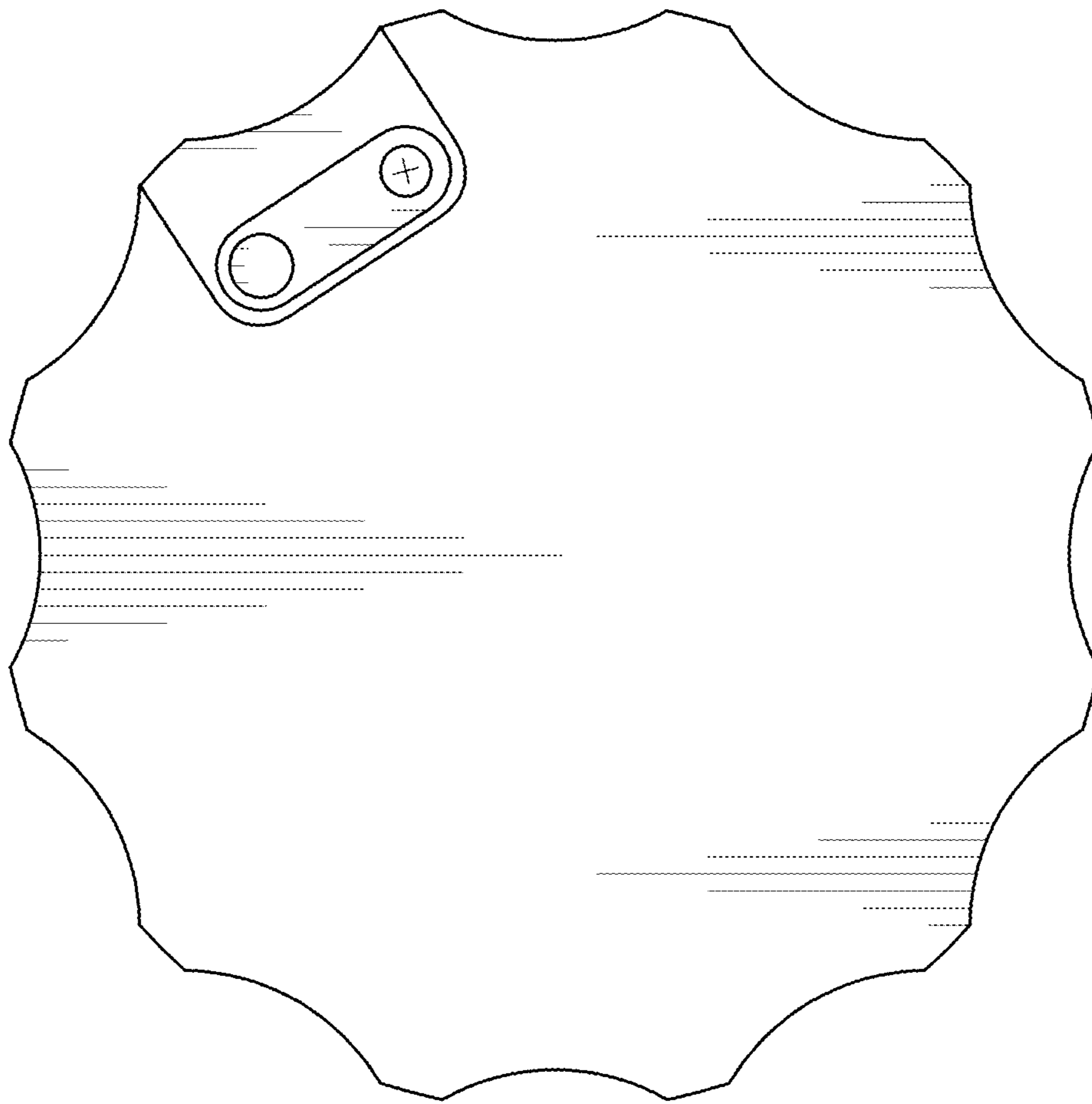

FIG. 7

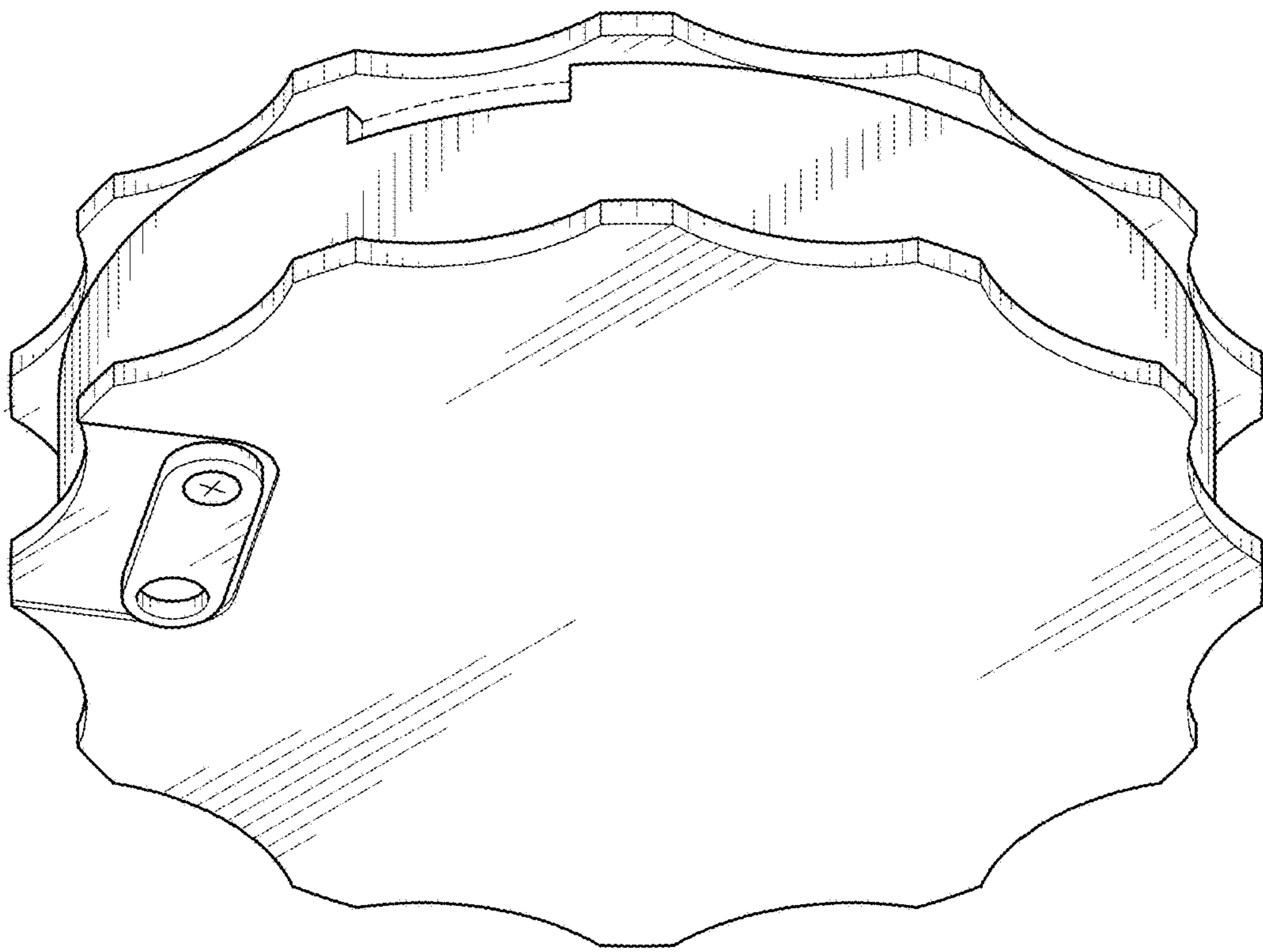

FIG. 8

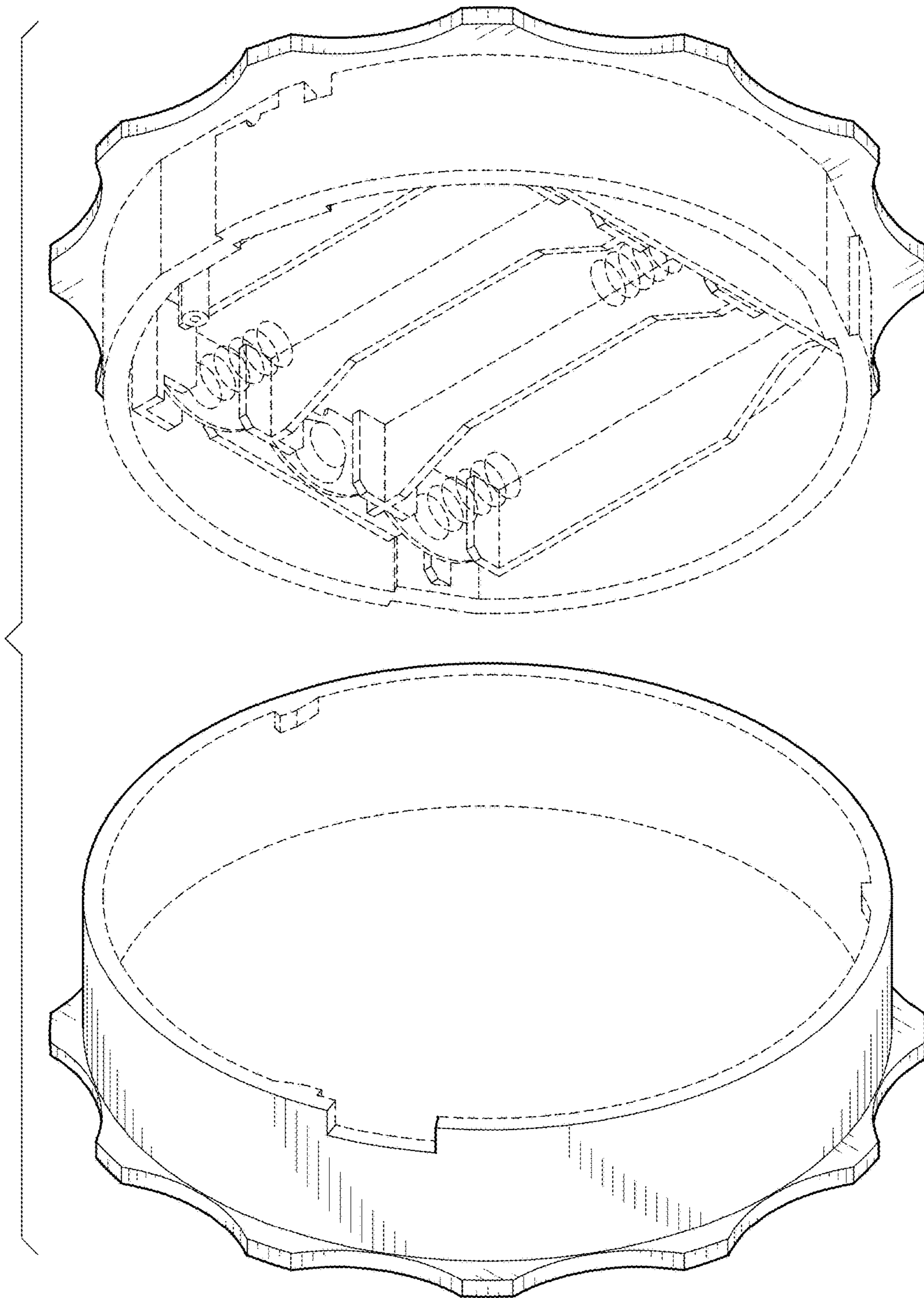

FIG. 9