



US00D841401S

(12) **United States Design Patent** (10) **Patent No.:** **US D841,401 S**
Jones et al. (45) **Date of Patent:** **** Feb. 26, 2019**

(54) **GRILL TRIVET**
(71) Applicant: **BASE4 Ventures, LLC**, Carrollton, TX (US)
(72) Inventors: **Autumn Alexis Jones**, Dallas, TX (US); **Joseph Charles Thompson**, Lewisville, TX (US)
(73) Assignee: **BASE 4 Ventures, Inc.**, Addison, TX (US)

D709,727 S * 7/2014 Cloutier D7/354
D740,134 S * 10/2015 Brinda D9/456
9,215,949 B1 * 12/2015 Cloutier A47J 37/0694
D761,614 S * 7/2016 Zemel D7/354
D770,232 S * 11/2016 Brown D7/554.3
D784,067 S * 4/2017 Keating D7/354
D784,077 S * 4/2017 Zemel D7/354
D790,926 S * 7/2017 Jones
D793,162 S * 8/2017 Hamlin D7/409
D824,726 S * 8/2018 Gershkow D7/409
D824,727 S * 8/2018 Gershkow D7/409
D825,979 S * 8/2018 Levy D7/359
D829,052 S * 9/2018 Gamble D7/409

(**) Term: **15 Years**

* cited by examiner

(21) Appl. No.: **29/620,890**

Primary Examiner — Kelley A Donnelly

(22) Filed: **Aug. 11, 2017**

(74) *Attorney, Agent, or Firm* — Jonathan E. Gran; Grant Patent Services

(51) **LOC (11) Cl.** **07-01**

(52) **U.S. Cl.** **D7/554.3**
USPC

(57) **CLAIM**

We claim the ornamental design for a grill trivet, as shown and described.

(58) **Field of Classification Search**
USPC D7/550.1, 554.3, 554.4, 560, 601–602, D7/354–355, 367, 409

DESCRIPTION

CPC A47G 23/04; B65D 23/00; B65D 25/00; A47J 33/00; A47J 36/26; A47J 37/06; A47J 43/18; A47J 47/14
See application file for complete search history.

FIG. 1—is a perspective view of the grill trivet;
FIG. 2—is a top view thereof;
FIG. 3—is a bottom view thereof;
FIG. 4 is a left side view;
FIG. 5 is a right side view;
FIG. 6—is a back view thereof; and,
FIG. 7—is a front view thereof.

(56) **References Cited**

U.S. PATENT DOCUMENTS

D648,175 S * 11/2011 Zemel D7/354
D682,552 S * 5/2013 Ambrefe, Jr. D3/304

1 Claim, 5 Drawing Sheets

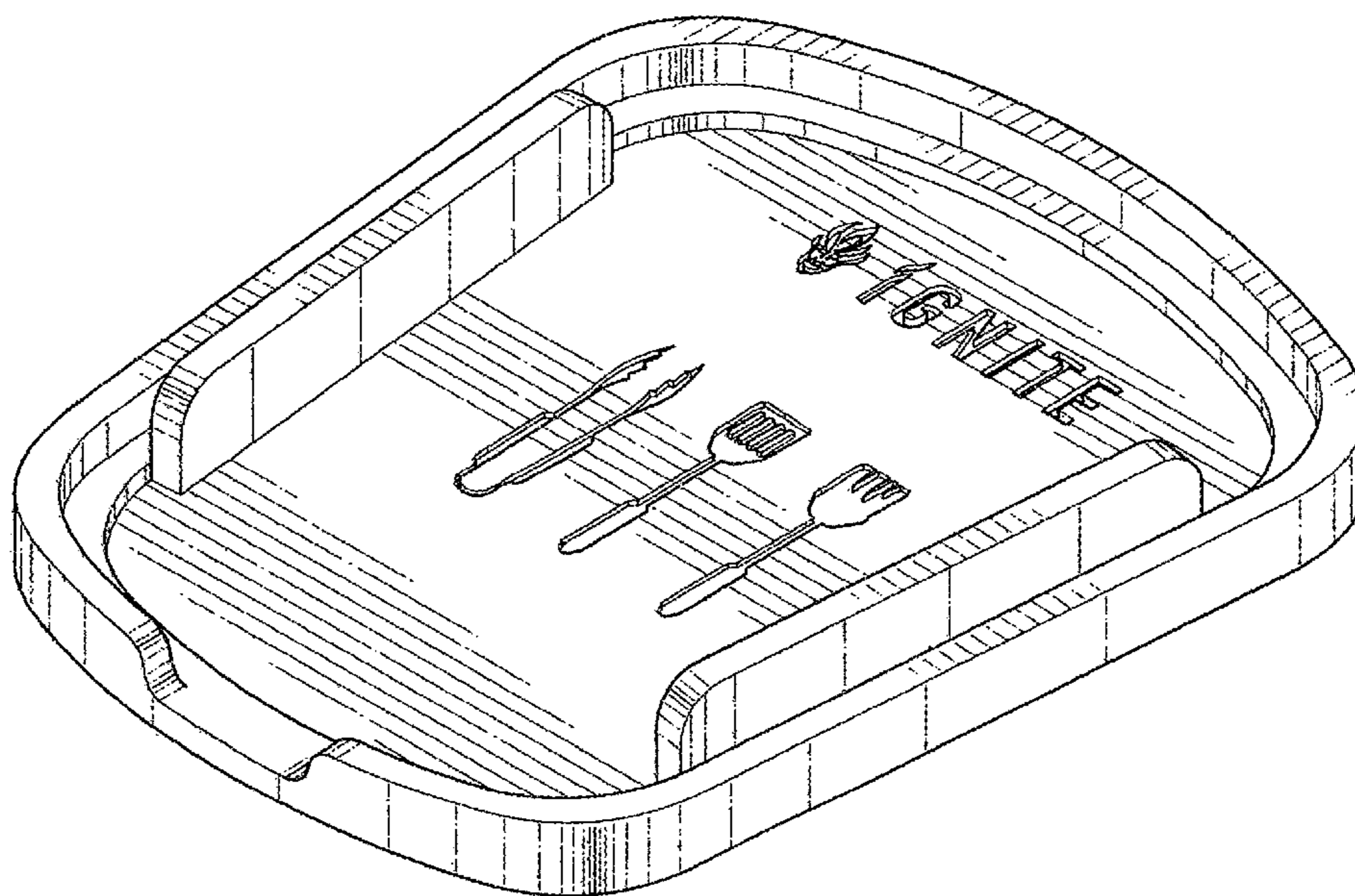

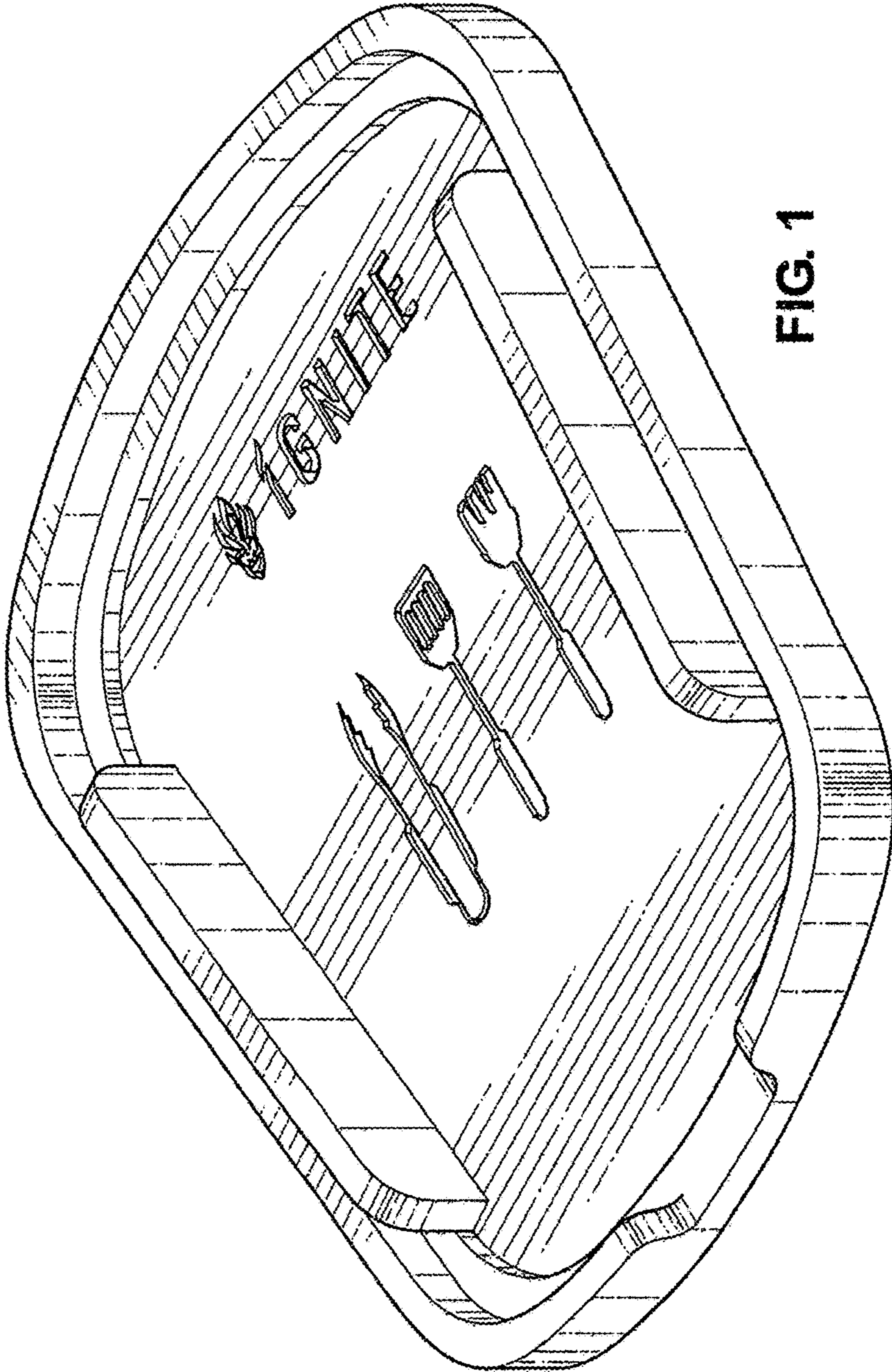

FIG. 1

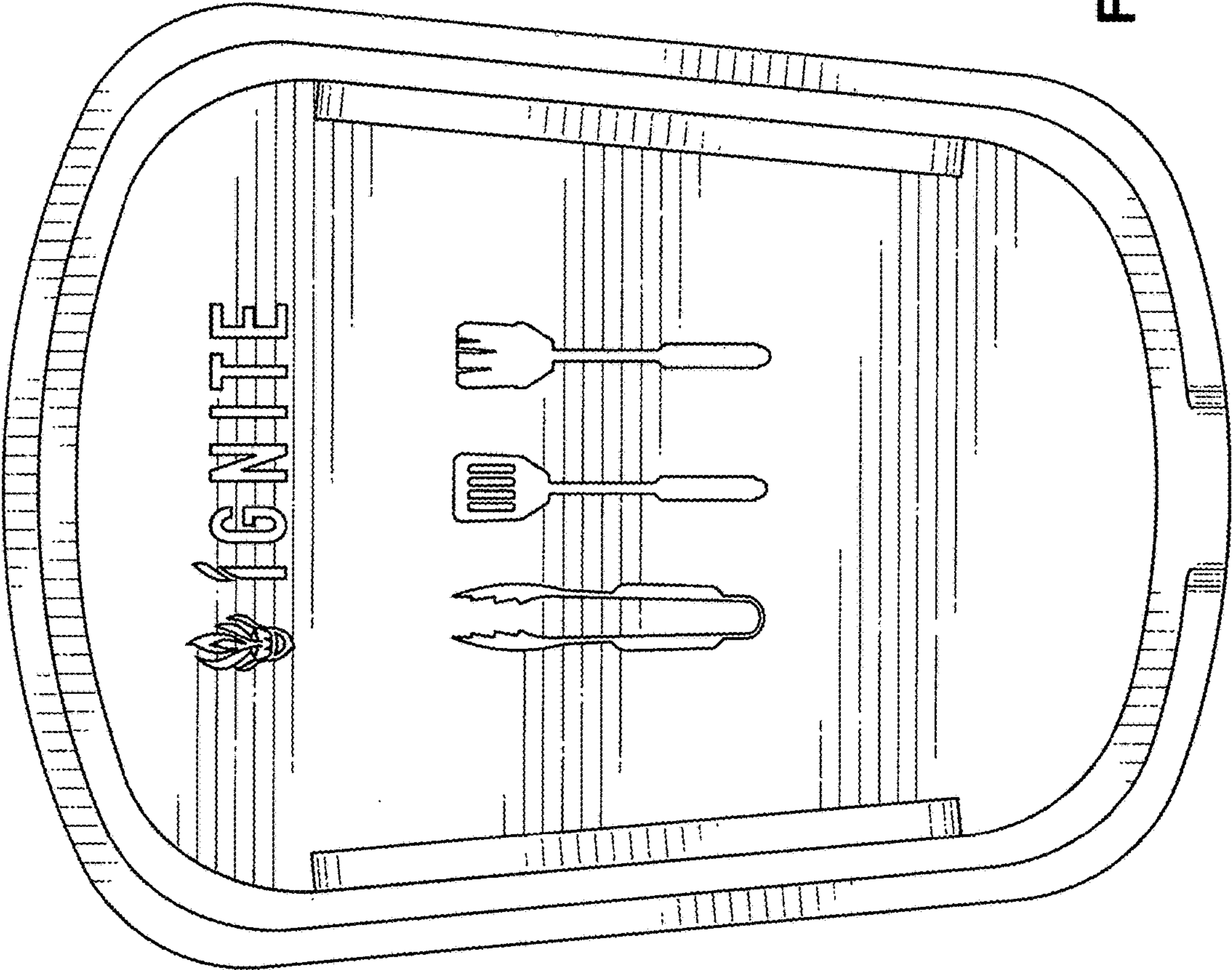

FIG. 2

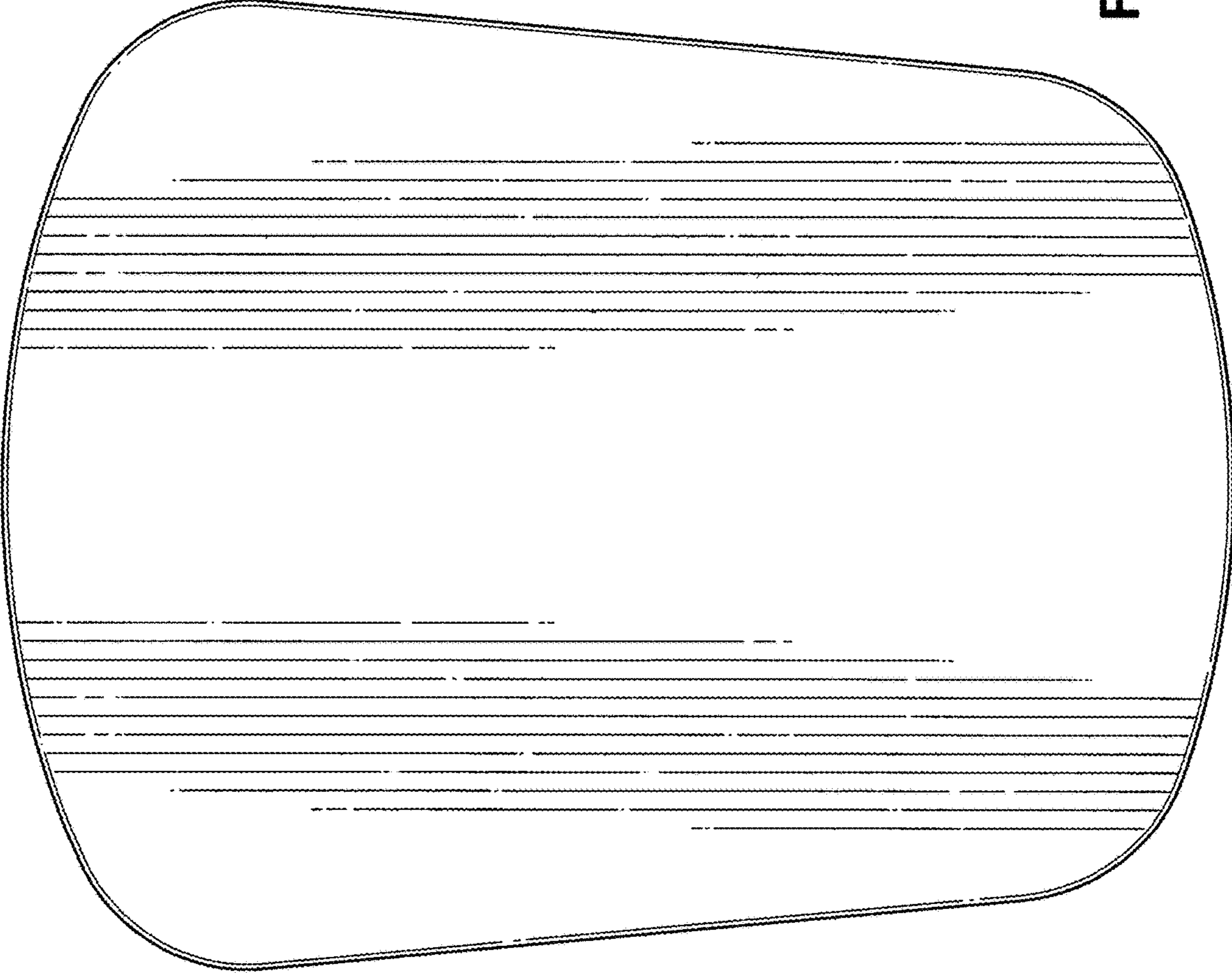

FIG. 3

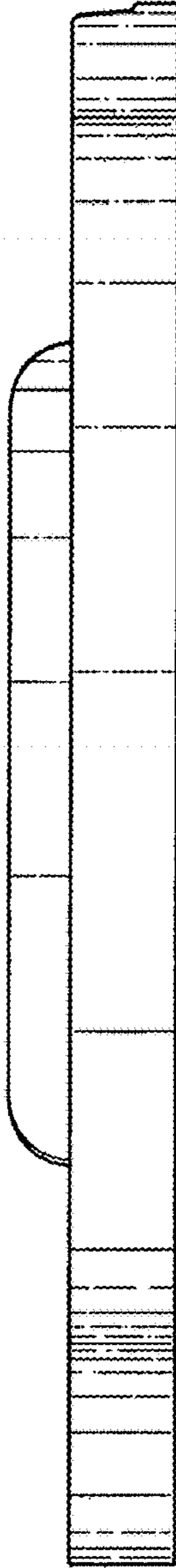

FIG. 4

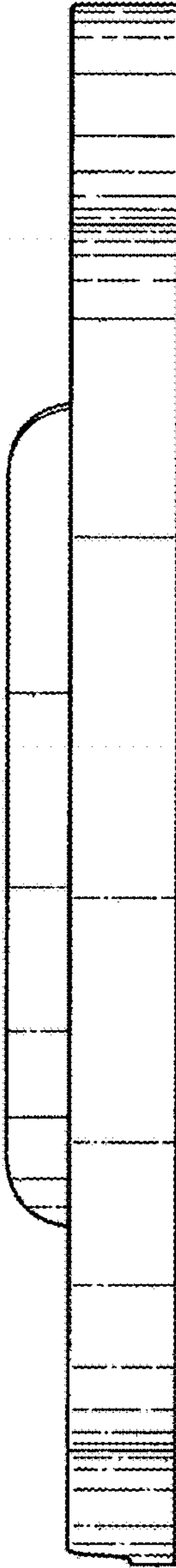

FIG. 5

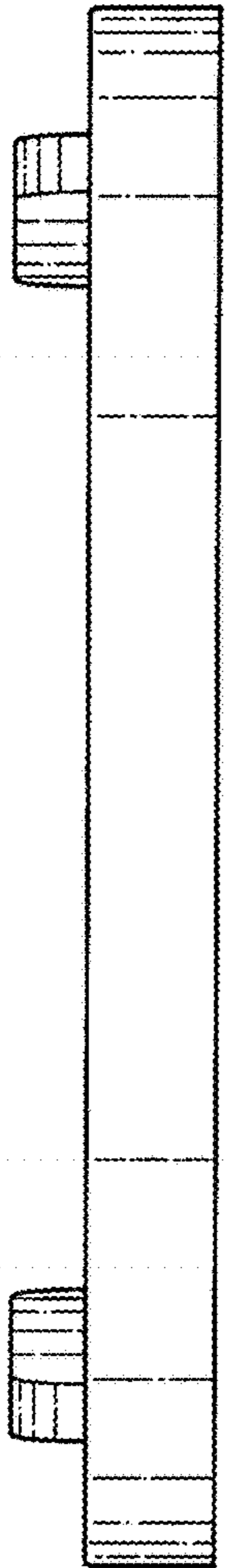

FIG. 6

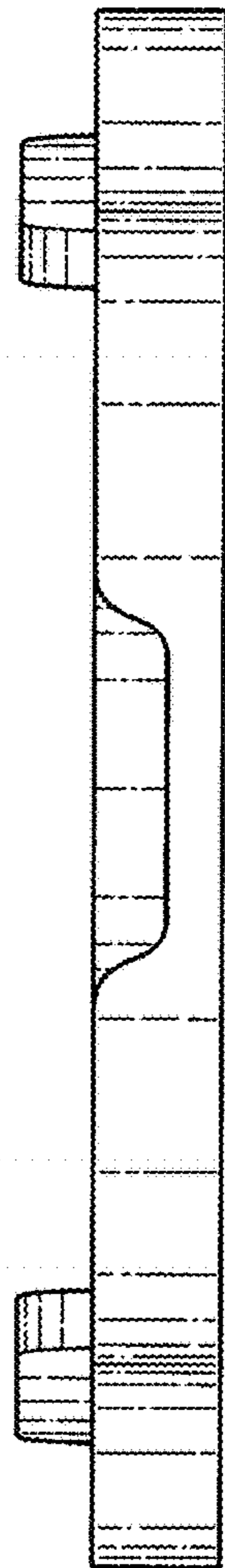

FIG. 7