



US00D841279S

(12) **United States Design Patent** (10) **Patent No.:** **US D841,279 S**
Freeman et al. (45) **Date of Patent:** **** Feb. 19, 2019**

(54) **SUBGRADE VAULT**

(56) **References Cited**

(71) Applicant: **Oldcastle Precast, Inc.**, Auburn, WA (US)

U.S. PATENT DOCUMENTS

(72) Inventors: **Eric Freeman**, Lodi, CA (US); **Nguyen Thai Dang**, Churchable (AU)

349,465 A	9/1886	Stevens
2,055,166 A	9/1936	Berry
2,114,499 A	4/1938	Maclear
2,291,290 A	7/1942	Tinnerman
2,342,312 A	2/1944	Tinnerman

(73) Assignee: **OLDCASTLE PRECAST, INC.**, Auburn, WA (US)

(Continued)

(**) Term: **15 Years**

FOREIGN PATENT DOCUMENTS

(21) Appl. No.: **29/618,330**

DE	3144890	5/1983
DE	29813074	11/1998

(22) Filed: **Sep. 20, 2017**

(Continued)

OTHER PUBLICATIONS

Related U.S. Application Data

“13x24 Series Box & Cover,” cdr Systems Corp., 1996, 1 page.

(63) Continuation of application No. 15/446,400, filed on Mar. 1, 2017, now Pat. No. 9,932,157, which is a continuation of application No. 14/925,561, filed on Oct. 28, 2015, now Pat. No. 9,919,853, which is a continuation of application No. 14/486,662, filed on Sep. 15, 2014, now Pat. No. 9,174,798, which is a continuation of application No. 13/294,054, filed on Nov. 10, 2011, now Pat. No. 8,835,757.

(Continued)

Primary Examiner — Elizabeth J Oswecki

(51) **LOC (11) Cl.** **99-00**

(74) *Attorney, Agent, or Firm* — Sheridan Ross PC

(52) **U.S. Cl.**

(57) **CLAIM**

USPC **D99/43**

The ornamental design for a subgrade vault, as shown and described.

(58) **Field of Classification Search**

DESCRIPTION

USPC D99/28, 34, 35, 36, 43, 99; 109/1 R, 109/1 V, 2, 45; 902/9.3, 9, 30; 235/100; 206/0.8, 0.815, 0.82; 312/400, 409
CPC F42B 39/24; E05B 65/0075; E05G 1/00; E05G 1/005; E05G 5/00; E05G 2700/00; E05G 2700/02; E05G 2700/04; E05G 5/02; G05G 1/024; G07D 11/0006; G07D 11/0009; G07D 9/002; G07D 9/008; G07D 11/009; G07F 9/06; G07F 9/003; G07F 17/10; G07F 17/12

FIG. 1 is a front perspective view of a subgrade vault showing our new design;
FIG. 2 is a front elevation view thereof;
FIG. 3 is a rear elevation view thereof;
FIG. 4 is a right side elevation view thereof;
FIG. 5 is a left side elevation view thereof;
FIG. 6 is a top plan view thereof; and,
FIG. 7 is a bottom plan view thereof.

The broken lines showing portions of the subgrade vault are included for the purpose of illustrating environment and form no part of the claimed design.

See application file for complete search history.

1 Claim, 5 Drawing Sheets

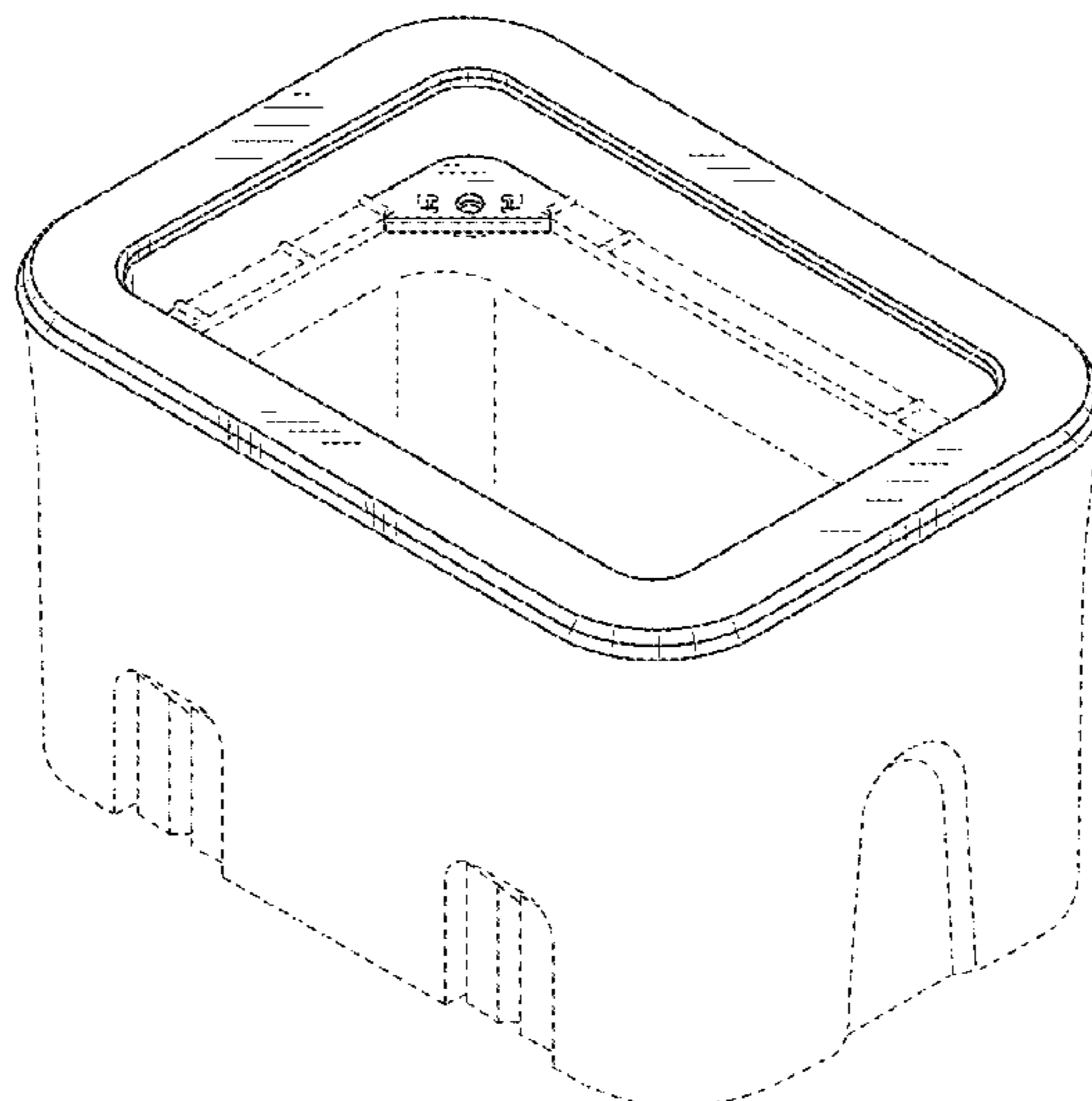

(56)

References Cited

U.S. PATENT DOCUMENTS

2,355,486	A	8/1944	Tinnerman		D367,211	S	2/1996	Cautereels	
2,364,668	A	12/1944	Simmons		5,549,411	A	8/1996	Hawkins	
2,367,659	A	1/1945	Burke		D373,953	S	9/1996	Gale	
2,385,927	A	10/1945	Mason		D376,693	S	12/1996	Wolff	
2,396,835	A	3/1946	Eggert		5,605,353	A	2/1997	Moss et al.	
2,401,671	A	6/1946	Thomas et al.		D379,138	S	5/1997	Carlson	
2,403,566	A	7/1946	Thorp et al.		5,627,340	A	5/1997	Smith et al.	
2,404,672	A	7/1946	Volf		D382,112	S	8/1997	Egan	
2,410,968	A	11/1946	Eggert		D385,673	S	* 10/1997	Siler	D3/201
2,410,988	A	11/1946	Mevi		5,694,719	A	12/1997	Bejune et al.	
2,434,844	A	1/1948	Flora		5,697,729	A	12/1997	Bowman	
2,552,499	A	5/1951	Tinnerman		D394,550	S	5/1998	Tanji	
2,682,211	A	6/1954	Avila		5,782,584	A	7/1998	Arthur	
2,693,100	A	11/1954	Weigel		5,829,215	A	11/1998	Billing	
2,727,552	A	12/1955	Chivosta		5,855,461	A	1/1999	Tripi	
2,931,383	A	4/1960	Handley		5,919,019	A	7/1999	Fischer	
3,029,964	A	4/1962	Hudson et al.		5,951,223	A	9/1999	Lindquist	
3,039,666	A	6/1962	Carpenter, Sr.		5,975,323	A	11/1999	Turan	
3,318,476	A	5/1967	Clark		5,987,824	A	11/1999	Fuller	
3,385,012	A	5/1968	Lovegreen		D417,361	S	12/1999	Mittmann et al.	
3,530,696	A	9/1970	Dunmire		6,000,576	A	12/1999	Liu	
3,720,251	A	3/1973	Sygnator		6,006,414	A	12/1999	Corporon et al.	
3,727,438	A	* 4/1973	Knaack	E05B 67/38 292/281	6,007,270	A	12/1999	Bowman	
3,760,234	A	9/1973	Jones et al.		D426,064	S	6/2000	Douglas et al.	
3,858,614	A	1/1975	Moore et al.		6,087,582	A	7/2000	Arthur	
D237,285	S	* 10/1975	Helenurm	D99/28	6,106,207	A	8/2000	Kuzdak, III	
3,911,635	A	10/1975	Traupe		6,164,885	A	12/2000	Roytberg et al.	
3,920,347	A	11/1975	Sauriol et al.		6,261,039	B1	7/2001	Reed	
3,921,494	A	11/1975	Coe		6,283,689	B1	9/2001	Roytberg et al.	
3,972,440	A	8/1976	Warren		6,321,928	B1	11/2001	Goldenstein et al.	
3,974,599	A	8/1976	Grosh		6,371,687	B1	4/2002	Heintz et al.	
D244,173	S	5/1977	Thurman		6,371,688	B1	4/2002	Yang et al.	
4,059,199	A	11/1977	Quaney		D469,607	S	2/2003	Wolff	
4,074,491	A	2/1978	Bell et al.		D474,596	S	* 5/2003	Osiecki	D3/273
4,163,503	A	8/1979	McKinnon		6,688,806	B2	2/2004	Kuan	
4,204,419	A	5/1980	Cale		6,752,565	B2	6/2004	Schrage	
4,266,380	A	5/1981	Samolis		6,764,261	B1	7/2004	Stadler	
4,461,597	A	7/1984	Laurin		6,772,566	B1	8/2004	Machledt et al.	
D279,952	S	8/1985	Daenen et al.		6,811,119	B1	11/2004	Petersen et al.	
4,567,697	A	2/1986	Hahne		6,820,760	B2	11/2004	Wegner et al.	
D289,582	S	* 5/1987	Brush, Jr.	D3/281	6,899,240	B2	5/2005	Dang et al.	
4,729,706	A	3/1988	Peterson et al.		6,932,099	B2	8/2005	Mahaney	
4,797,045	A	1/1989	Lautenschlager, Jr. et al.		D510,802	S	10/2005	Sagol	
4,844,518	A	7/1989	Pritchard		6,953,209	B2	10/2005	Jackson et al.	
D302,491	S	* 8/1989	Brush, Jr.	D3/294	6,992,252	B1	1/2006	Rao et al.	
4,863,059	A	9/1989	Christensen		7,009,513	B2	3/2006	Dang	
4,863,327	A	9/1989	Poupiter		7,030,315	B1	4/2006	Dunn et al.	
4,867,600	A	9/1989	Bowman		7,128,495	B1	10/2006	Lill et al.	
4,883,397	A	11/1989	Dubost		D531,802	S	11/2006	Zimmerman	
4,897,005	A	1/1990	Peterson et al.		7,163,352	B2	1/2007	Jurich et al.	
4,911,594	A	3/1990	Fisher		7,201,533	B2	4/2007	DeGreef	
4,919,578	A	4/1990	Zeigler et al.		D547,175	S	7/2007	Berg	
4,948,181	A	8/1990	Pritchard		D569,073	S	* 5/2008	Osiecki	D99/28
4,973,191	A	11/1990	Dannhauser		D570,074	S	* 5/2008	Osiecki	D99/28
4,976,568	A	12/1990	Hess		D571,524	S	* 6/2008	Kang	D99/28
4,998,332	A	3/1991	Dacey, Jr.		7,385,137	B2	6/2008	Burke et al.	
5,026,235	A	6/1991	Muller et al.		D574,124	S	* 7/2008	Huber	D99/28
5,123,776	A	6/1992	Lang et al.		D574,125	S	* 7/2008	Gunst	D99/28
5,134,758	A	8/1992	Christensen		D579,625	S	* 10/2008	Kang	D99/28
5,152,651	A	10/1992	Artéon		7,467,910	B2	12/2008	Lecuyer et al.	
5,176,482	A	1/1993	Reinl		7,484,908	B2	2/2009	Stadler	
5,197,307	A	3/1993	Abbott, Jr.		7,500,412	B1	3/2009	Maciejewski	
5,205,668	A	4/1993	Adams		7,501,573	B2	3/2009	Balfour, Jr.	
D335,378	S	* 5/1993	Mariol	D99/28	D590,709	S	4/2009	Fitzsimmons	
5,249,901	A	10/1993	Moore		D598,197	S	8/2009	Ahlstrom	
5,324,135	A	6/1994	Smith		7,607,553	B2	10/2009	Weber	
5,330,303	A	7/1994	Dubost		D606,306	S	12/2009	Monte	
5,375,940	A	12/1994	Kobayashi		7,748,926	B2	7/2010	Jurich et al.	
5,378,097	A	1/1995	Barnavol		D622,061	S	8/2010	Higginson	
D355,118	S	2/1995	Dickinson et al.		D624,275	S	* 9/2010	Min	D99/28
D357,161	S	4/1995	Booten		7,807,923	B2	10/2010	Moran	
D361,511	S	8/1995	Dickinson et al.		7,855,338	B2	12/2010	Troder	
5,462,383	A	10/1995	Van 'T Veer		7,891,904	B2	2/2011	Stadler	
5,484,076	A	1/1996	Petrushka		D639,065	S	6/2011	Duvigneau	
					D640,138	S	6/2011	Lee	
					D648,538	S	11/2011	Reinhart et al.	
					8,061,928	B2	11/2011	Jurich et al.	
					D654,693	S	2/2012	Freeman	
					8,113,740	B2	2/2012	Boulton et al.	

(56)

References Cited

OTHER PUBLICATIONS

U.S. PATENT DOCUMENTS

8,156,773	B1	4/2012	Olson et al.	
D662,323	S	6/2012	Jurich et al.	
8,242,386	B1	8/2012	Baldwin et al.	
8,272,528	B2	9/2012	Dunn	
8,302,796	B1	11/2012	Johnson	
D682,553	S	5/2013	Jurich et al.	
8,469,628	B2	6/2013	Miller et al.	
D693,535	S *	11/2013	Henderson	D99/28
D696,526	S	12/2013	Christensen	
8,821,062	B2	9/2014	Miller et al.	
8,835,757	B2	9/2014	Freeman	
8,921,712	B1	12/2014	Gretz	
8,944,266	B2	2/2015	Roemer et al.	
D730,015	S *	5/2015	Osiecki	D99/28
9,021,842	B2	5/2015	Rix	
D731,739	S *	6/2015	Hine	D99/28
D732,264	S *	6/2015	Hine	D99/28
D732,265	S *	6/2015	Osiecki	D99/28
9,054,509	B2	6/2015	Knapp	
9,174,798	B2	11/2015	Freeman	
9,346,593	B2	5/2016	Dang	
9,435,099	B2	9/2016	Dang	
D772,522	S *	11/2016	Henderson	D99/28
D799,149	S *	10/2017	Chafetz	D99/28
D800,989	S *	10/2017	Lucido	D99/28
D803,508	S *	11/2017	Horn	D99/28
D811,687	S *	2/2018	Kang	D99/28
D817,589	S *	5/2018	Culbreth	D99/28
2002/0100146	A1	8/2002	Ko	
2003/0202857	A1	10/2003	Lowry et al.	
2003/0206785	A1	11/2003	Hoffmann	
2004/0042849	A1	3/2004	Jurich et al.	
2004/0244444	A1	12/2004	Wadsworth	
2006/0088378	A1	4/2006	Pendleton et al.	
2007/0194493	A1	8/2007	Jurich et al.	
2008/0048460	A1	2/2008	Brady et al.	
2008/0095592	A1	4/2008	Spitz	
2008/0159824	A1	7/2008	Okada et al.	
2008/0169392	A1	7/2008	McClure et al.	
2008/0226417	A1	9/2008	Spitz	
2008/0247842	A1	10/2008	Motsch et al.	
2008/0310931	A1	12/2008	Cisik et al.	
2009/0087279	A1	4/2009	McGinn et al.	
2009/0226260	A1	9/2009	Boulton et al.	
2010/0040433	A1	2/2010	Poppe et al.	
2010/0132168	A1	6/2010	Coffland et al.	
2010/0296865	A1	11/2010	Jurich et al.	
2010/0310338	A1	12/2010	Diez Herrera	
2010/0329782	A1	12/2010	Miller et al.	
2011/0203334	A1	8/2011	Rix	
2011/0290802	A1	12/2011	Burros	
2012/0073106	A1	3/2012	Jurich et al.	
2012/0228302	A1	9/2012	Byrns	
2013/0205674	A1	8/2013	Damon	
2013/0263425	A1	10/2013	Miller et al.	
2016/0046440	A1	2/2016	Freeman	
2016/0176629	A1	6/2016	Dang	
2016/0369474	A1	12/2016	Dang	
2017/0166368	A1	6/2017	Freeman	

FOREIGN PATENT DOCUMENTS

EP	0390767	10/1990
EP	0529178	3/1993
EP	1004709	5/2000
FR	2760765	9/1998
FR	2890671	3/2007
GB	2175630	12/1986
GB	2207164	1/1989
GB	2276405	9/1994
GB	2378971	2/2003
GB	2390629	1/2004
WO	WO 98/53151	11/1998

“1324 Grade Ring, HDPE, Green,” Oldcastle Precast, Inc., 2008, 2 pages.

“1324-12 Body Fibrelyte 2x Floating Nut Provision,” Oldcastle Precast, Inc., 2010, 5 pages.

17x30 Flared Wall Series, Box, Cover & Extension, cdr Systems Corp., 2002, 1 page.

17x30 Straight Wall Series, Box & Cover, cdr Systems Corp., 2002, 1 page.

“6-inch Standard Extension,” Oldcastle Precast, Inc., 2009, 1 page.

“Body, 1730-24, HDPE, Green, Split-Cover Prov.,” Carson Industries LLC (now Oldcastle Precast), 2004, 1 page.

“Caltrans Revised Standard Plans,” California Department of Transportation, 2004, Part 1, 34 pages.

“Caltrans Revised Standard Plans,” California Department of Transportation, 2004, Part 2, 35 pages.

“Caltrans Revised Standard Plans,” California Department of Transportation, 2004, Part 3, 31 pages.

“Complaint with Jury Demand,” filed Aug. 1, 2014 (Case 2:14-cv-01815-WBS-EFB), 61 pages.

“Concrete Products Catalog,” Oldcastle Precast, Inc., 2009, 90 pages.

“Concrete Products, Inc. Catalog,” Christy Concrete Products (now Oldcastle Precast, Inc.), 1999, 5 pages.

“Dry Utilities Polymer and Plastic Products Catalog,” Oldcastle Precast, Inc., 2003, Part I, 63 pages.

“Dry Utilities Polymer and Plastic Products Catalog,” Oldcastle Precast, Inc., 2003, Part II, 73 pages.

“Dry Utilities Polymer and Plastic Products Catalog,” Oldcastle Precast, Inc., 2009, Part I, 79 pages.

“Dry Utilities Polymer and Plastic Products Catalog,” Oldcastle Precast, Inc., 2009, Part II, 81 pages.

“Enclosure Solutions for Fiber & Copper Cable,” Oldcastle Precast, 2009, 8 pages.

“F12 Fiberlyte,” Christy Concrete, 2003, 1 page.

“Grade Ring with Installation Kit,” Oldcastle Precast, 2008, 2 pages.

“SA32-1324-24 Box & Cover Assembly,” cdr Systems Corp, 1991, 1 page.

“Secondary Enclosures for Electric Underground,” PG&E, 2009, 15 pages.

“Series 36 Pull Box,” Oldcastle Precast, 2002, 2 pages.

“Series 38 Pull Box,” Oldcastle Precast, 2002, 2 pages.

“Series 66 Pull Box,” Oldcastle Precast, 2002, 2 pages.

Specifications for Commercial Construction, Roseville Electric, 2000, 3 pages.

“Super Jumbo XL,” Oldcastle Precast, Inc., 2009, 2 pages.

“Super Jumbo,” Oldcastle Precast, Inc., 2009, 2 pages.

“Syn1730D Polymer Concrete Lid,” Oldcastle Precast, Inc., 2008, 1 page.

“Telephone Electric CATV,” Pencil Plastics, Inc., 2007, 4 pages.

“Underground Enclosure with Fastener,” date unknown, 2 pages.

“Underground Enclosures and Pads,” Quazite, Hubbell Lenoir City, Inc., 2009, 107 pages.

Utility Infrastructure Price List, Carson Industries LLC, 2005, 18 pages.

“Western Underground Committee Guide 3.6,” Western Underground, date unknown, 14 pages.

Eisel Enterprises Inc. Precast Concrete Products, date unknown, 21 pages.

US Concrete Precast Group Products, date unknown, 9 pages.

Brooks Products Meter Boxes and Pull Boxes, drawing revision date Dec. 6, 2000, 17 pages.

Brooks Products Meter Boxes and Pull Boxes, drawing revision date Jan. 9, 2001, 4 pages.

Manning et al., “Tourist’s Death on Strip Worries County,” Las Vega Sun, 2003, 2 pages.

Stephens, “Handholes and Underground Electrical Enclosures,” NEC Digest, Strongwell Corp., 2005, 10 pages.

US Trade Dress Application No. 85/272,629, filed Mar. 21, 2011; Reg. No. 4,204,419, issued Sep. 11, 2012, 2 pages.

(56)

References Cited

OTHER PUBLICATIONS

US Trade Dress Application No. 85/272,635, filed Mar. 21, 2011; Reg. No. 4,204,420, issued Sep. 11, 2012, 2 pages.
Official Action for U.S. Appl. No. 13/294,054, dated Feb. 27, 2014 11 pages.
Notice of Allowance for U.S. Appl. No. 13/294,054, dated Jun. 23, 2014 7 pages.
Official Action for U.S. Appl. No. 14/486,662, dated Mar. 27, 2015 7 pages.
Notice of Allowance for U.S. Appl. No. 14/486,662, dated Jul. 8, 2015 9 pages.
Official Action for U.S. Appl. No. 14/486,662, dated Mar. 14, 2016 14 pages.
Final Action for U.S. Appl. No. 14/925,561, dated Dec. 23, 2016, 10 pages.
Notice of Allowance for U.S. Appl. No. 14/925,561, dated Jun. 1, 2017, 7 pages.
Official Action for U.S. Appl. No. 15/446,400, dated May 19, 2017 11 pages.
Official Action for U.S. Appl. No. 13/851,809, dated Mar. 27, 2015 7 pages.
Official Action for U.S. Appl. No. 13/851,809, dated Sep. 17, 2015 12 pages.
Notice of Allowance for U.S. Appl. No. 13/851,809, dated Jan. 22, 2016 9 pages.
Official Action for U.S. Appl. No. 14/081,829, dated Jan. 13, 2015 6 pages Restriction Requirement.
Official Action for U.S. Appl. No. 14/081,829, dated Apr. 24, 2015 13 pages.
Official Action for U.S. Appl. No. 14/081,829, dated Oct. 7, 2015 14 pages.
Notice of Allowance for U.S. Appl. No. 14/081,829, dated May 5, 2016 5 pages.
Notice of Allowance for Design U.S. Appl. No. 29/386,380, dated Feb. 29, 2012, 9 pages.

Official Action for Design U.S. Appl. No. 29/424,306, dated Sep. 13, 2012, 7 pages.
Notice of Allowance for Design U.S. Appl. No. 29/424,306, dated Jan. 7, 2013, 5 pages.
Notice of Allowance for Design U.S. Appl. No. 29/378,870, dated Nov. 4, 2011, 9 pages.
U.S. Appl. No. 13/294,054, filed Nov. 10, 2011 now U.S. Pat. No. 8,835,757.
U.S. Appl. No. 14/486,662, filed Sep. 15, 2014 now U.S. Pat. No. 9,174,798.
U.S. Appl. No. 14/925,562, filed Oct. 28, 2015.
U.S. Appl. No. 15/446,400, filed Mar. 1, 2017.
U.S. Appl. No. 13/851,809, filed Mar. 27, 2013 now U.S. Pat. No. 9,346,593.
U.S. Appl. No. 14/971,646, filed Dec. 16, 2015.
U.S. Appl. No. 14/081,829, filed Nov. 15, 2013 now U.S. Pat. No. 9,435,099.
U.S. Appl. No. 15/257,041, filed Sep. 6, 2016.
U.S. Appl. No. 29/386,380, filed Feb. 28, 2011 now U.S. Pat. No. D662,323.
U.S. Appl. No. 29/424,306, filed Jun. 11, 2012 now U.S. Pat. No. D682,553.
U.S. Appl. No. 29/378,870, filed Nov. 10, 2010 now U.S. Pat. No. D654,693.
Notice of Allowance for U.S. Appl. No. 14/925,561, dated Nov. 15, 2017 7 pages.
Notice of Allowance for U.S. Appl. No. 15/446,400, dated Nov. 21, 2017 9 pages.
Official Action (Restriction Requirement) for U.S. Appl. No. 15/257,041, dated Feb. 8, 2018 6 pages.
Official Action for U.S. Appl. No. 14/971,646, dated Apr. 5, 2018, 7 pages.
Official Action for U.S. Appl. No. 15/257,041, dated May 24, 2018, 8 pages.

* cited by examiner

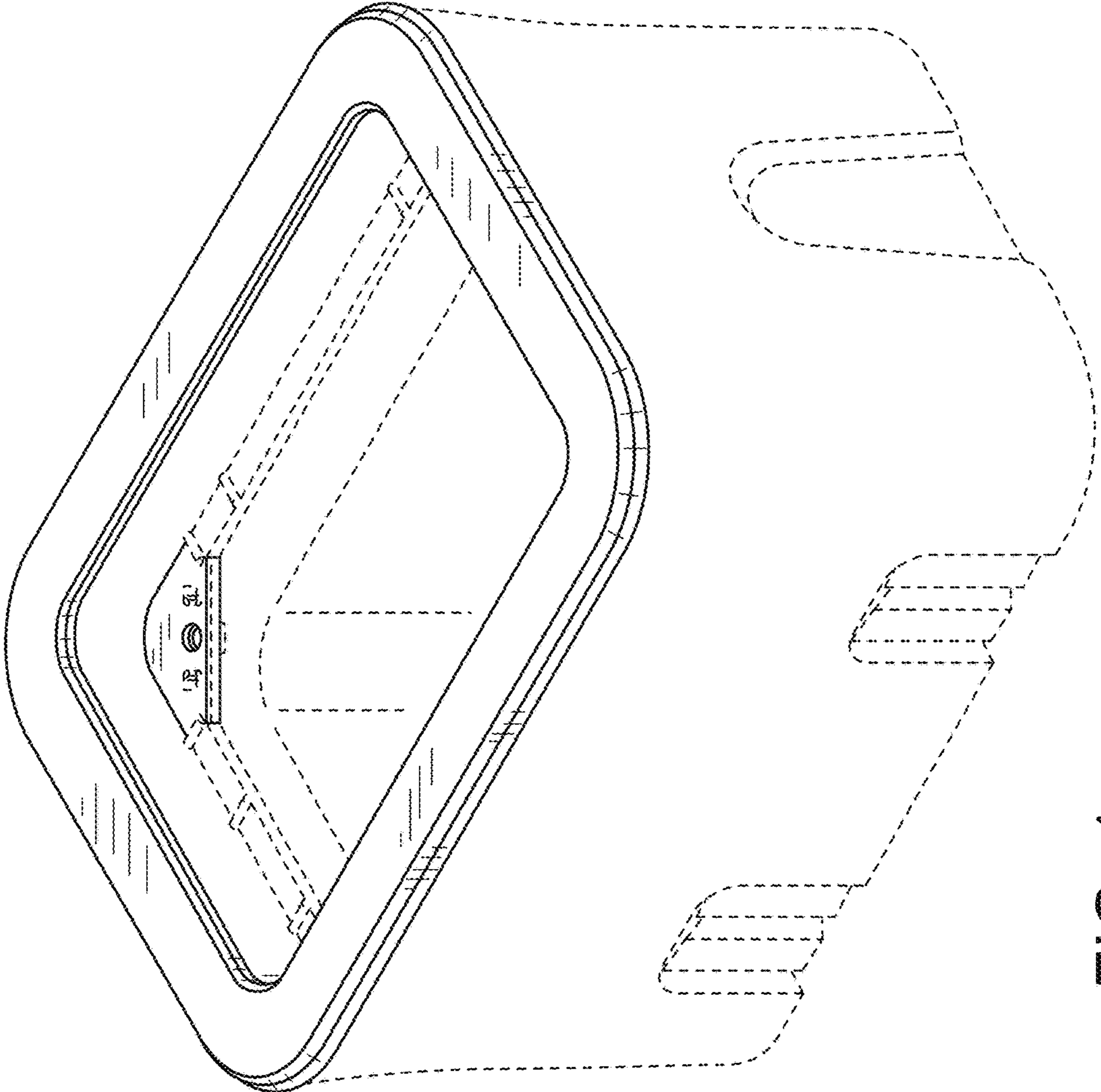

FIG. 1

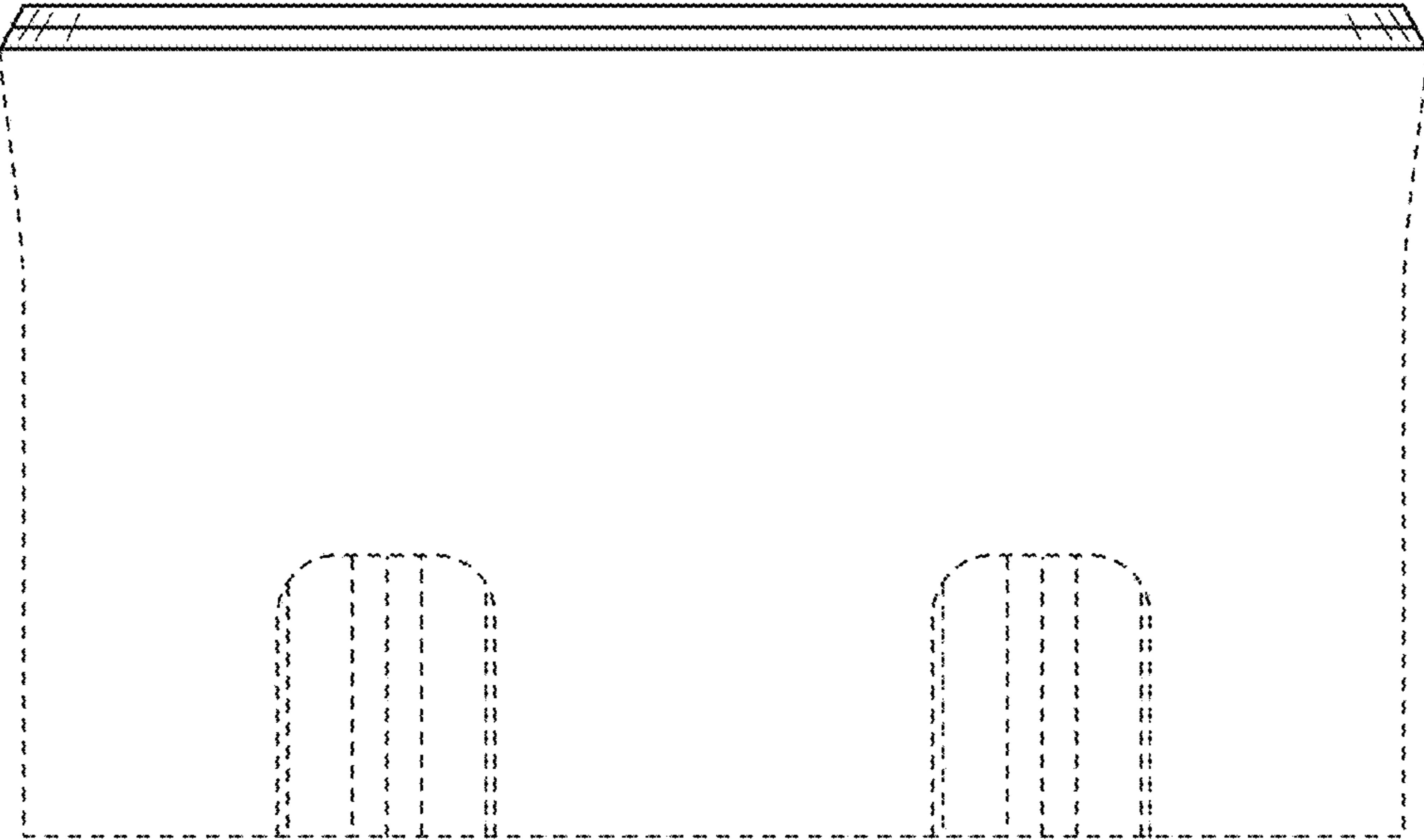

FIG. 2

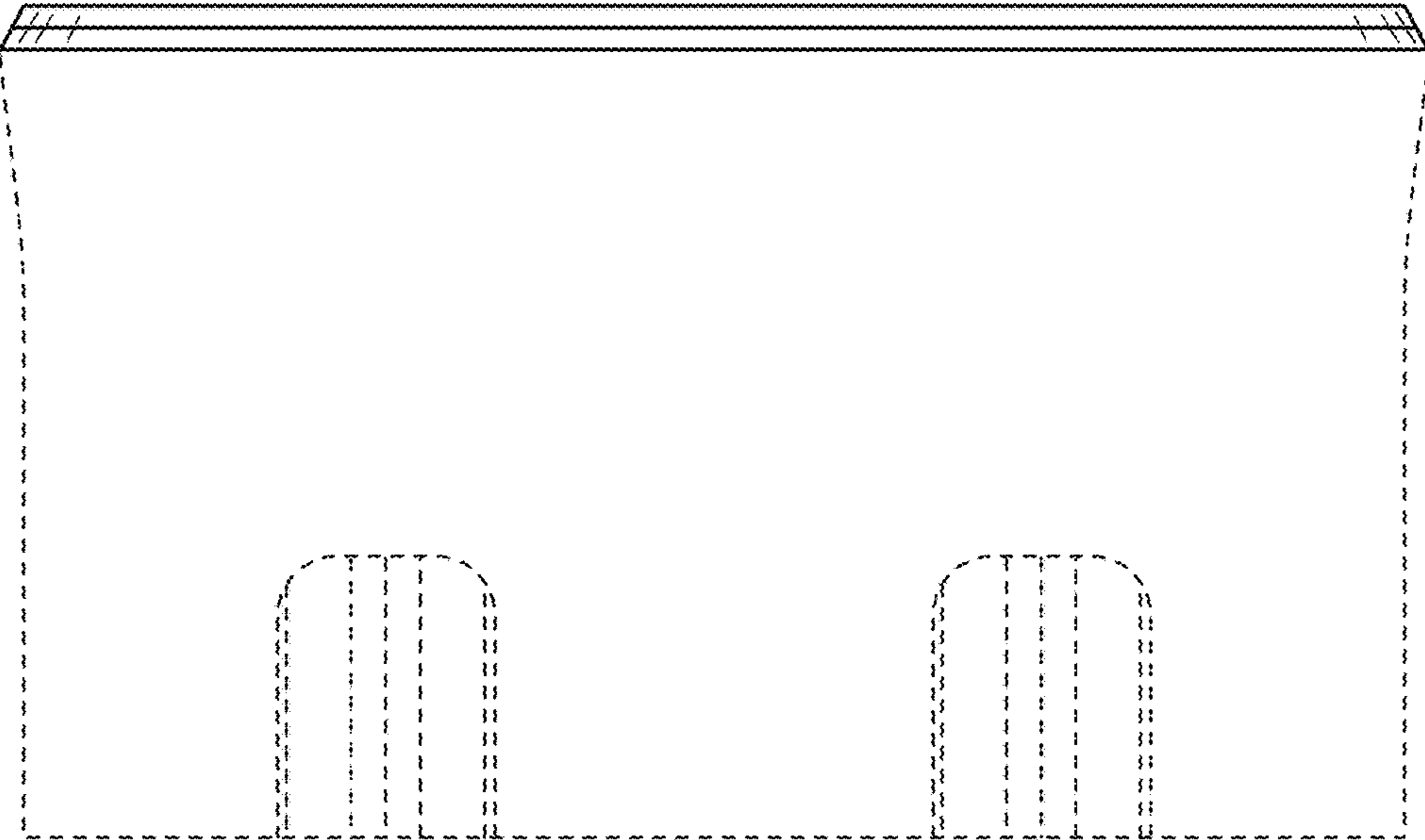

FIG. 3

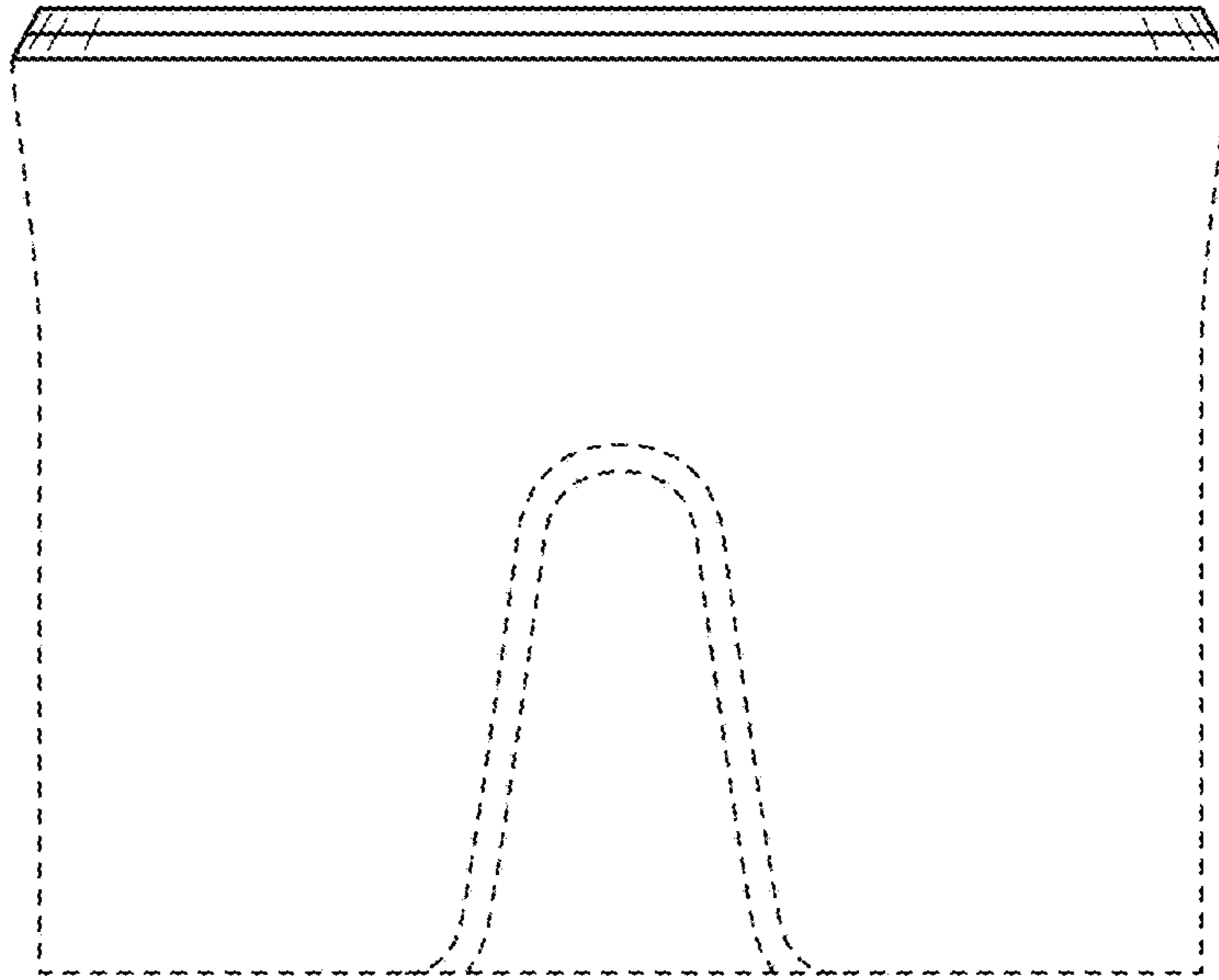

FIG. 4

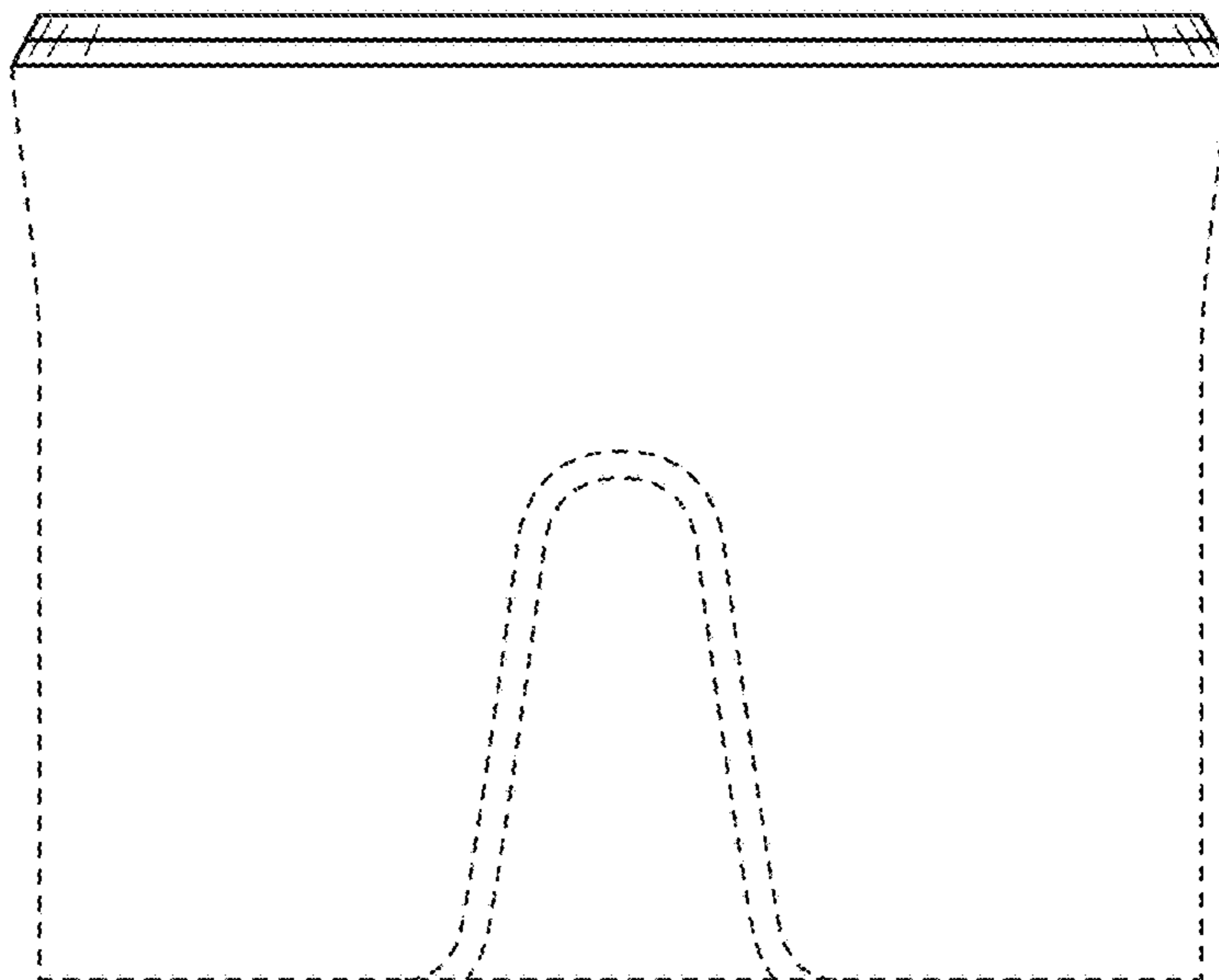

FIG. 5

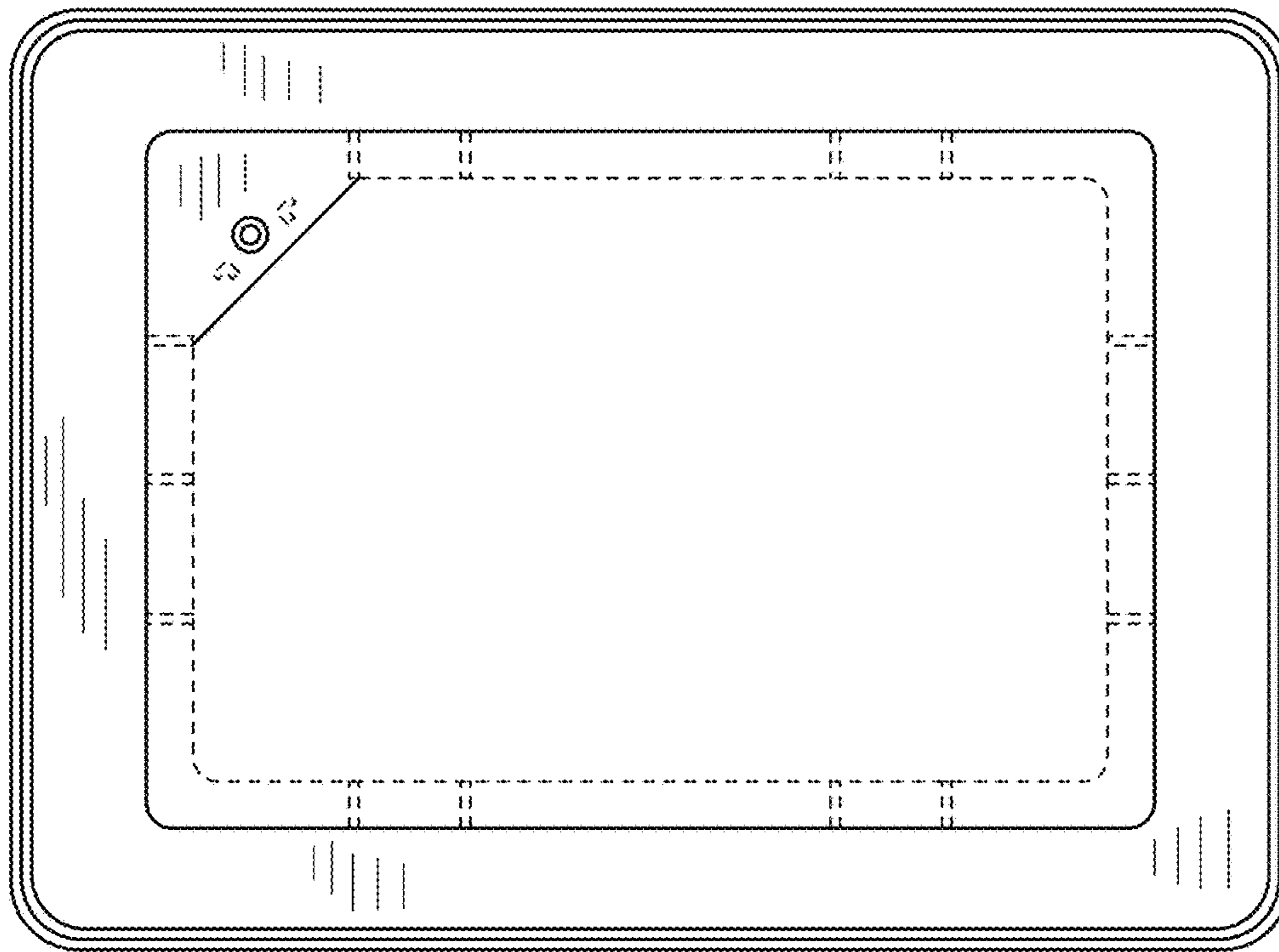

FIG. 6

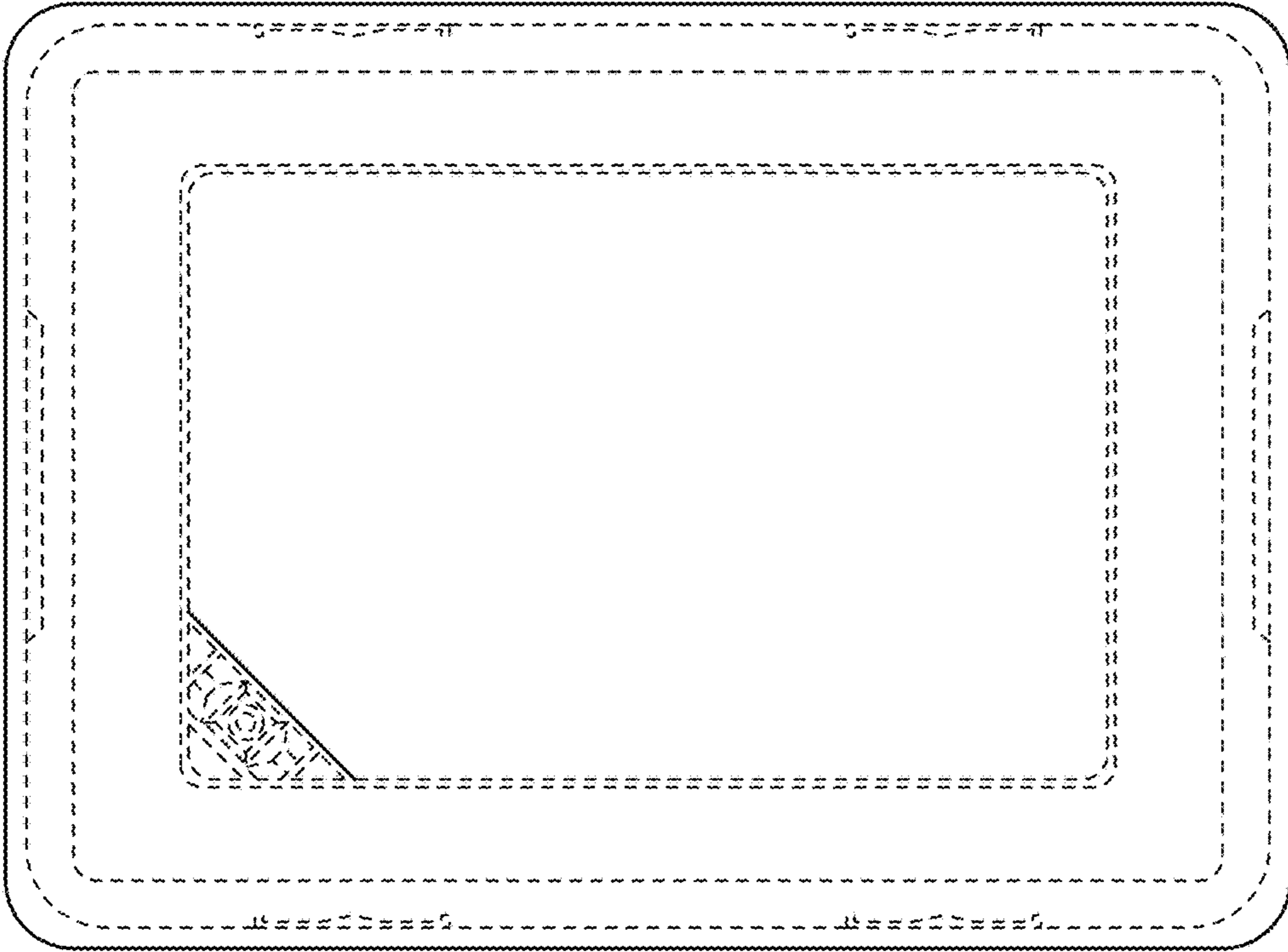

FIG. 7