



US00D841211S

(12) **United States Design Patent** (10) **Patent No.:** **US D841,211 S**
Wang (45) **Date of Patent:** **** Feb. 19, 2019**

(54) **STAGE LIGHT**
(71) Applicant: **Xiaodong Wang**, Henan (CN)
(72) Inventor: **Xiaodong Wang**, Henan (CN)
(**) Term: **15 Years**
(21) Appl. No.: **29/653,778**
(22) Filed: **Jun. 19, 2018**
(51) **LOC (11) Cl.** **26-03**
(52) **U.S. Cl.**
USPC **D26/63**
(58) **Field of Classification Search**
USPC D26/1, 24, 61, 63, 65, 37, 118, 120, 138,
D26/139
CPC F21V 21/14; F21V 15/01; F21V 14/02;
F21V 21/30; F21V 21/00; F21V 14/00;
F21S 8/00; F21S 8/003; F21S 8/043;
F21Y 2105/001
See application file for complete search history.

D802,815 S 11/2017 Kjaergaard Toft et al.
D802,816 S 11/2017 Kjaergaard Toft et al.
D808,069 S 1/2018 Kjaergaard Toft et al.
D808,070 S 1/2018 Kjaergaard Toft et al.
D814,090 S * 3/2018 Deng D26/63
D814,686 S * 4/2018 Chen D26/110
D823,514 S * 7/2018 Timtchenko D26/63

* cited by examiner

Primary Examiner — Brian N. Vinson

(57) **CLAIM**

The ornamental design for a stage light, as shown and described.

DESCRIPTION

FIG. 1 is a perspective view of a stage light showing my new design;
FIG. 2 is a front elevational view thereof, shown the upper part detaching with the body;
FIG. 3 is a front elevational view of the body of the stage light, shown separately for completeness of illustration;
FIG. 4 is a rear elevational view thereof, shown separately for completeness of illustration;
FIG. 5 is a left side elevational view thereof, shown separately for completeness of illustration;
FIG. 6 is a right side elevational view thereof, shown separately for completeness of illustration;
FIG. 7 is a top plan view thereof, shown separately for completeness of illustration;
FIG. 8 is a bottom plan view thereof, shown separately for completeness of illustration; and,
FIG. 9 is a perspective view thereof, shown separately for completeness of illustration.
The broken lines shown in drawings are for the purpose of illustrating portions of the stage light and form no part of the claimed design.

(56) **References Cited**

U.S. PATENT DOCUMENTS

1,592,561 A * 7/1926 Godley F21S 41/00
362/339
D425,232 S 5/2000 Chang
D542,957 S 5/2007 Chang
D575,891 S 8/2008 Calleja
D613,885 S 4/2010 Lodhie
D630,372 S 1/2011 Lodhie
D672,900 S 12/2012 Gailly et al.
D689,221 S * 9/2013 Isaac D26/24
D700,385 S 2/2014 Quadri
D702,387 S 4/2014 Pedersen
D759,871 S 6/2016 Consuegra
D770,656 S 11/2016 Quadri
D773,093 S * 11/2016 Dworschak D26/63

1 Claim, 9 Drawing Sheets

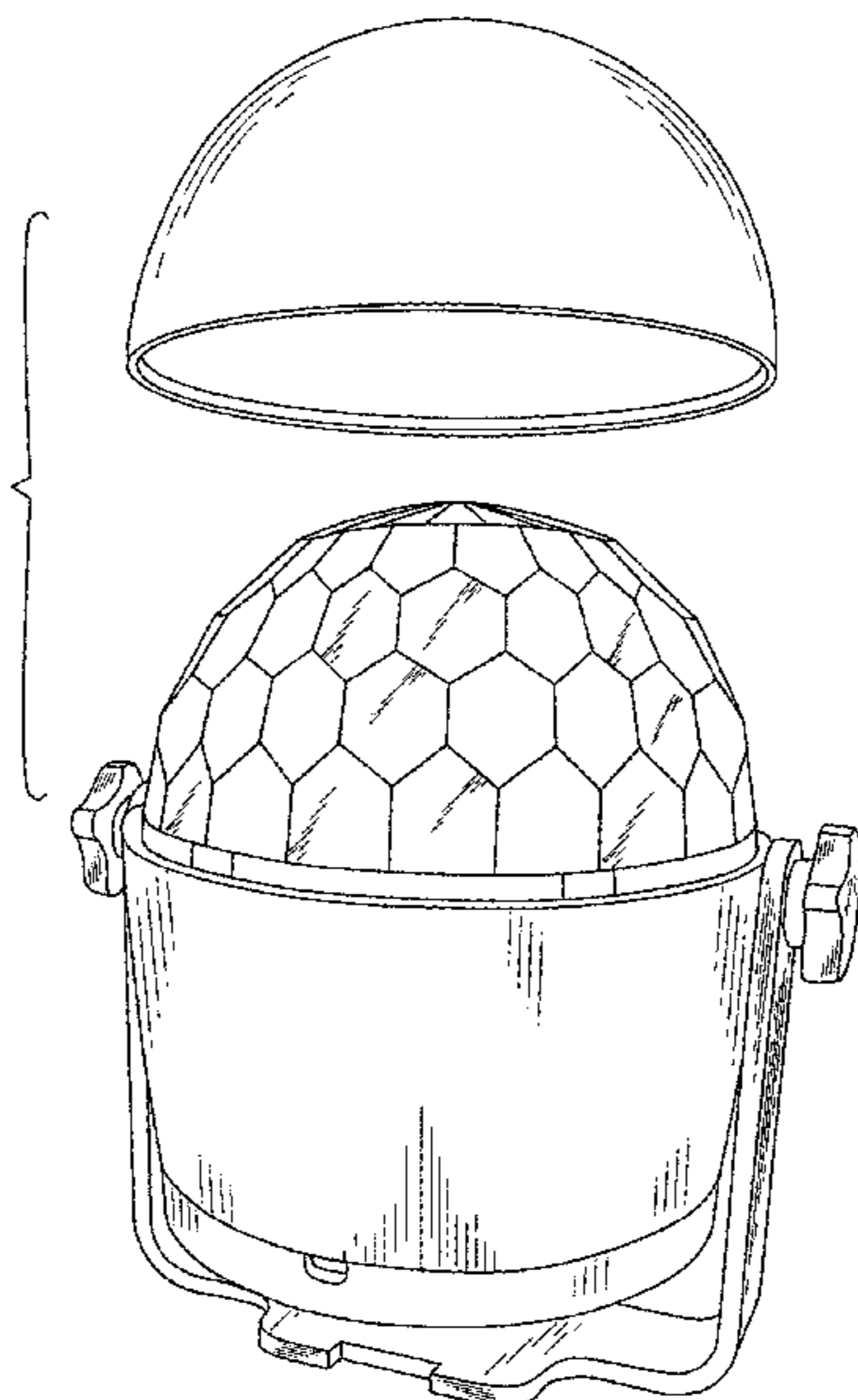

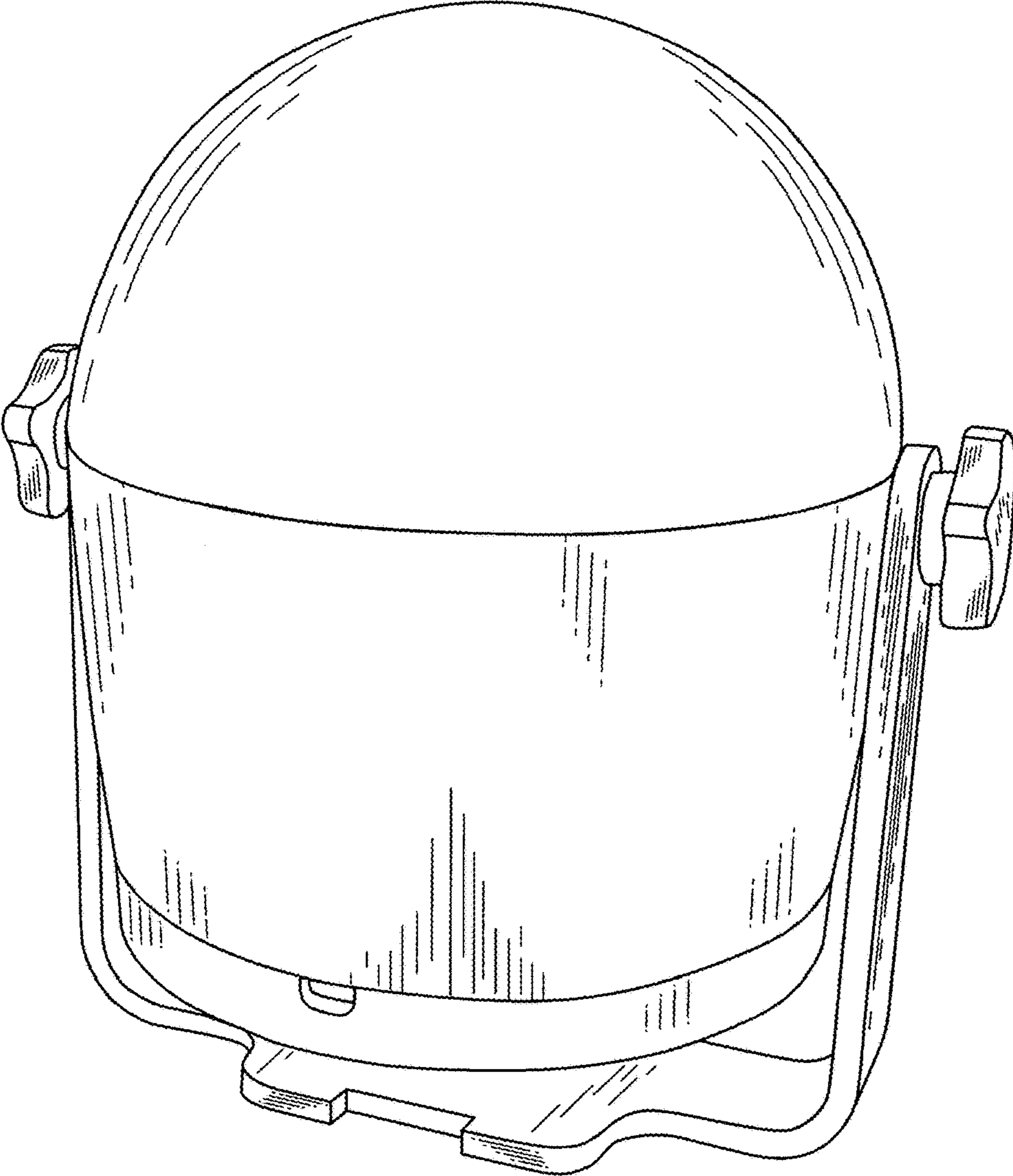

Figure 1

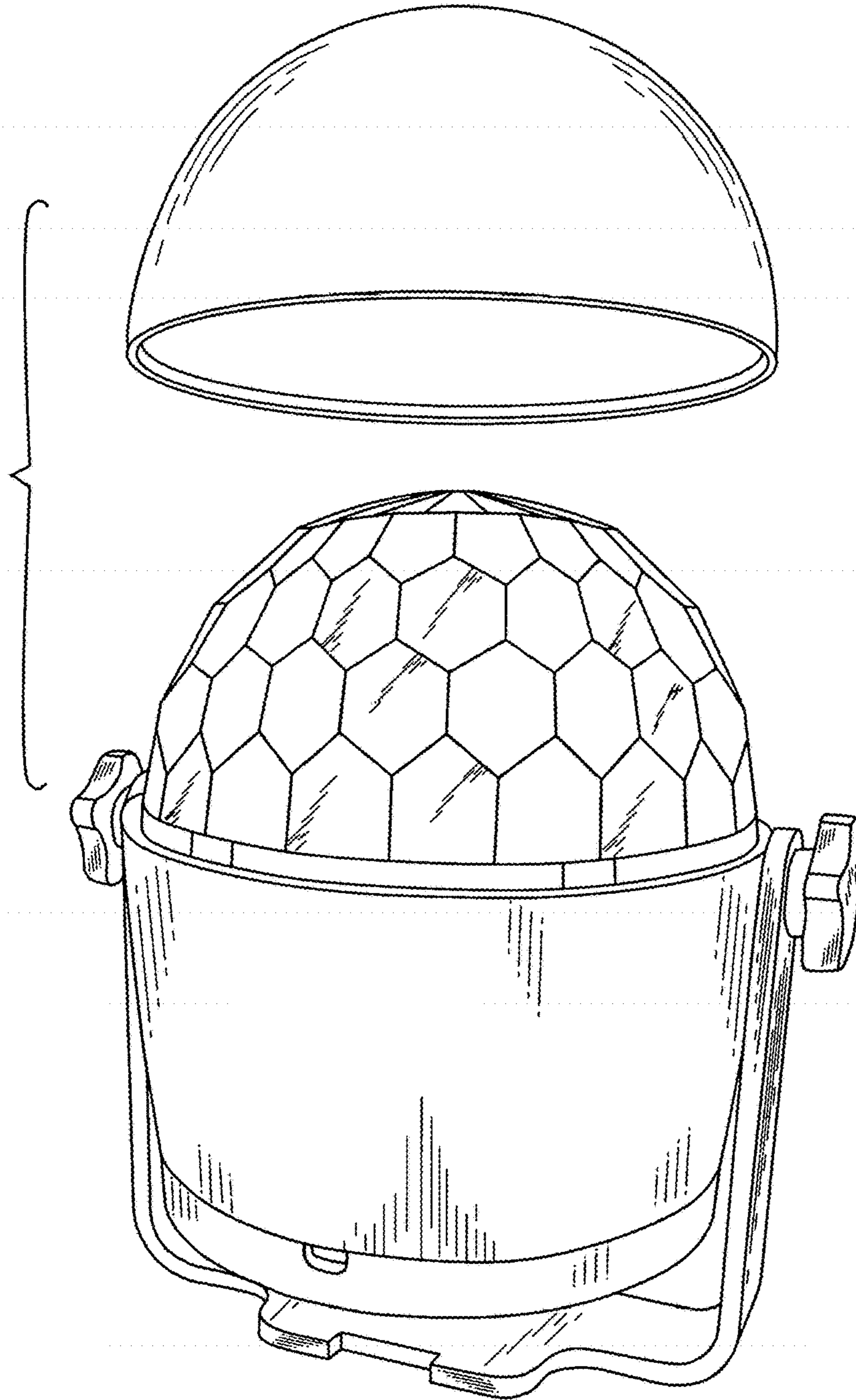

Figure 2

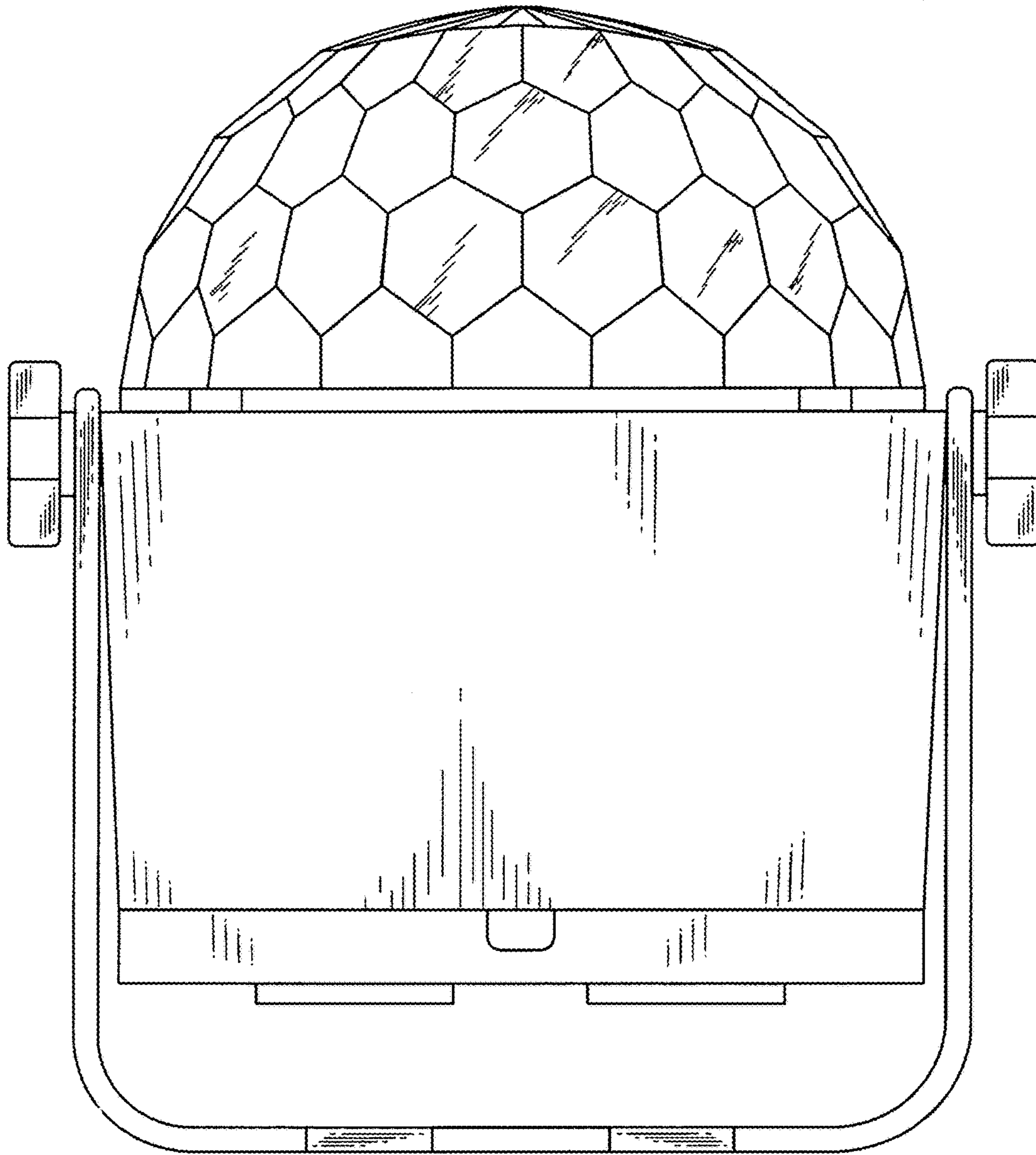

Figure 3

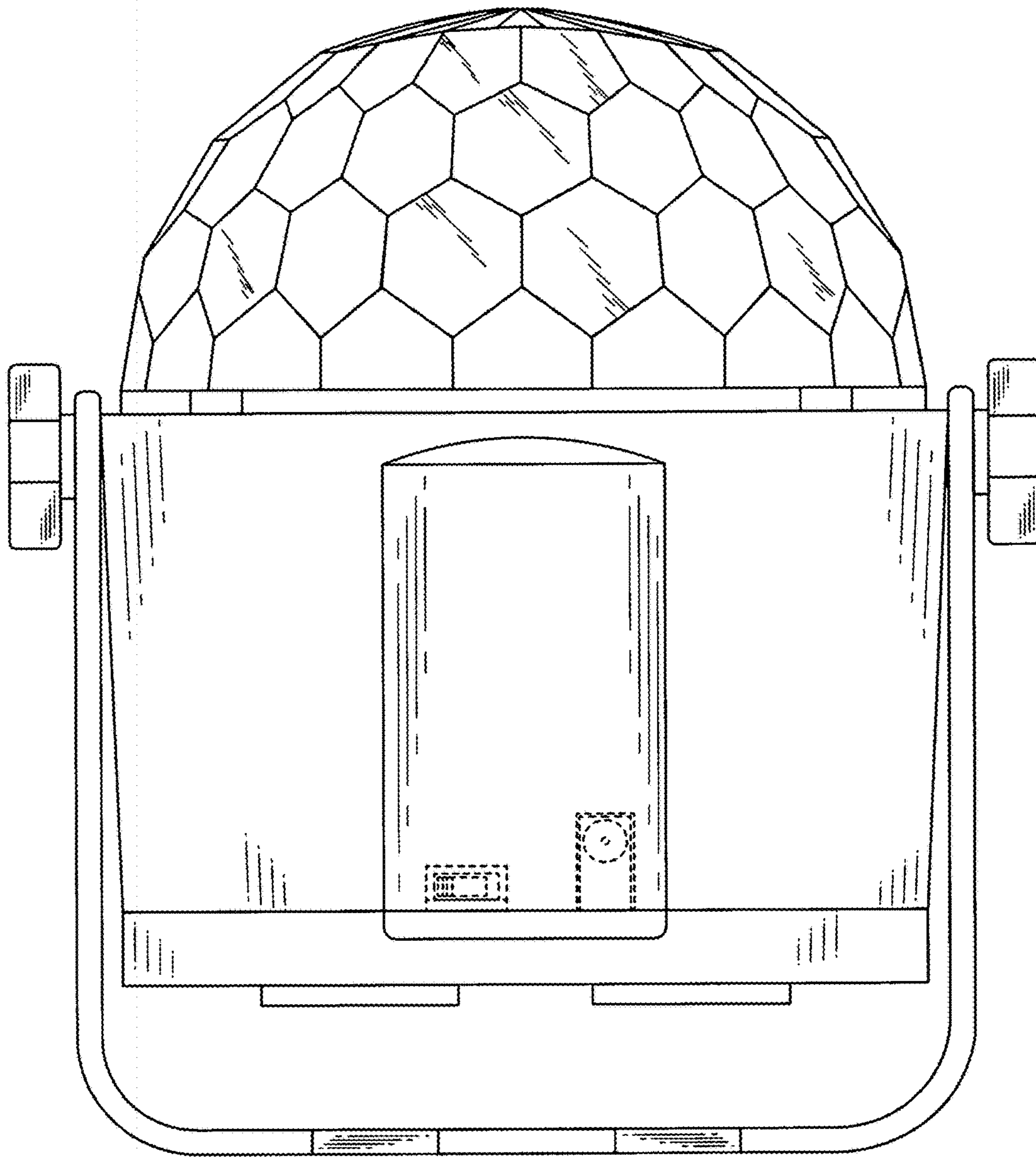

Figure 4

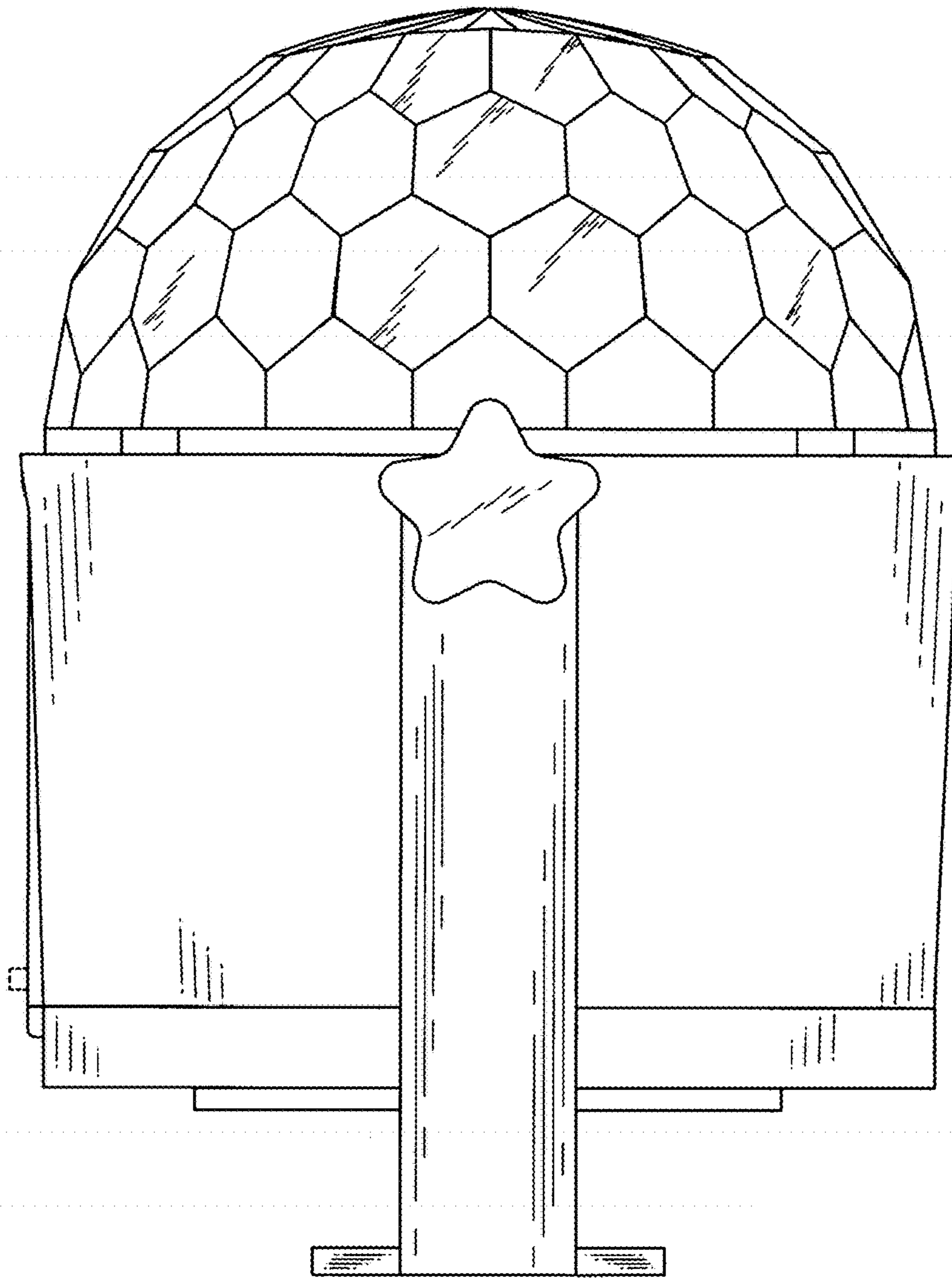

Figure 5

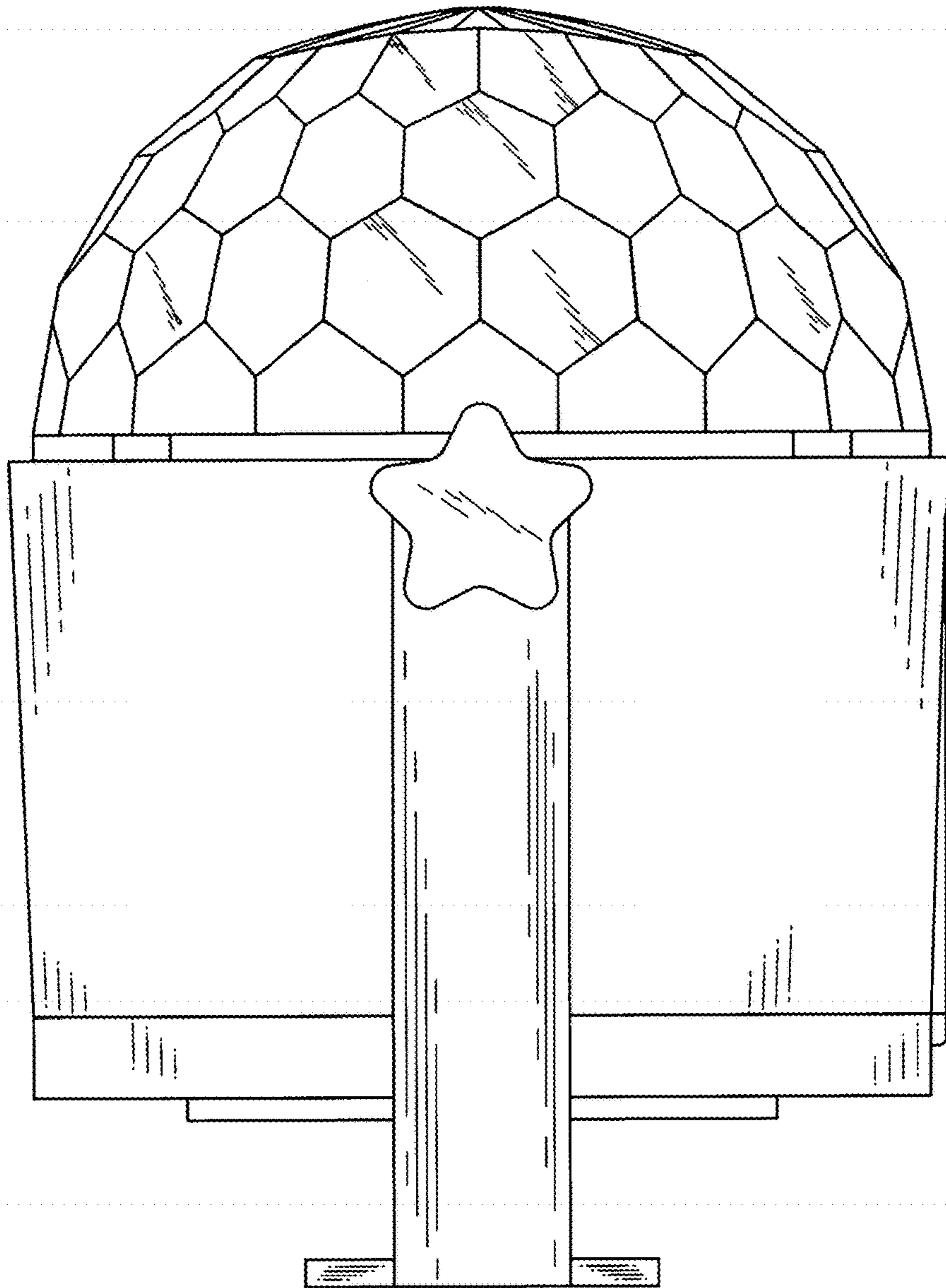

Figure 6

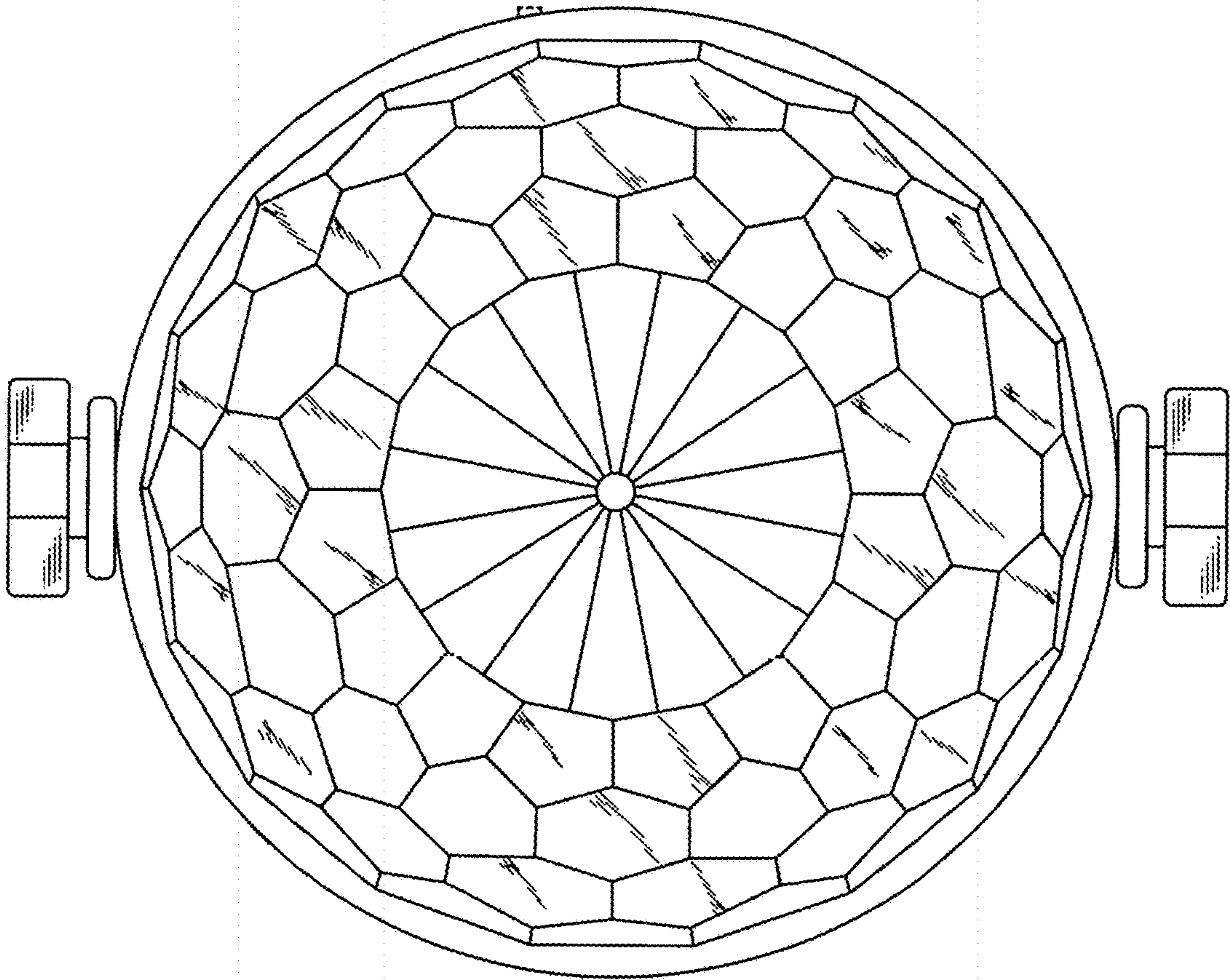

FIG.7

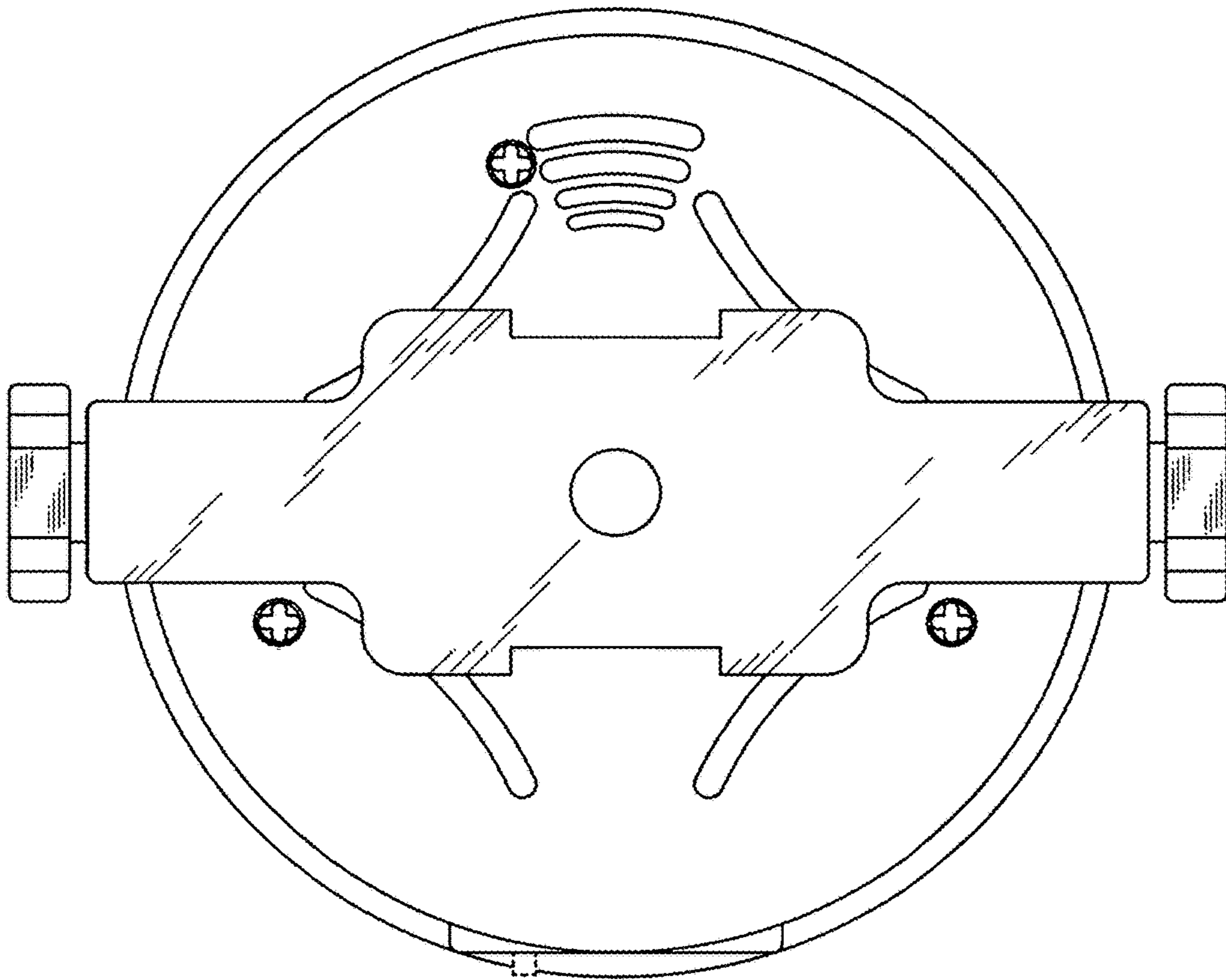

FIG.8

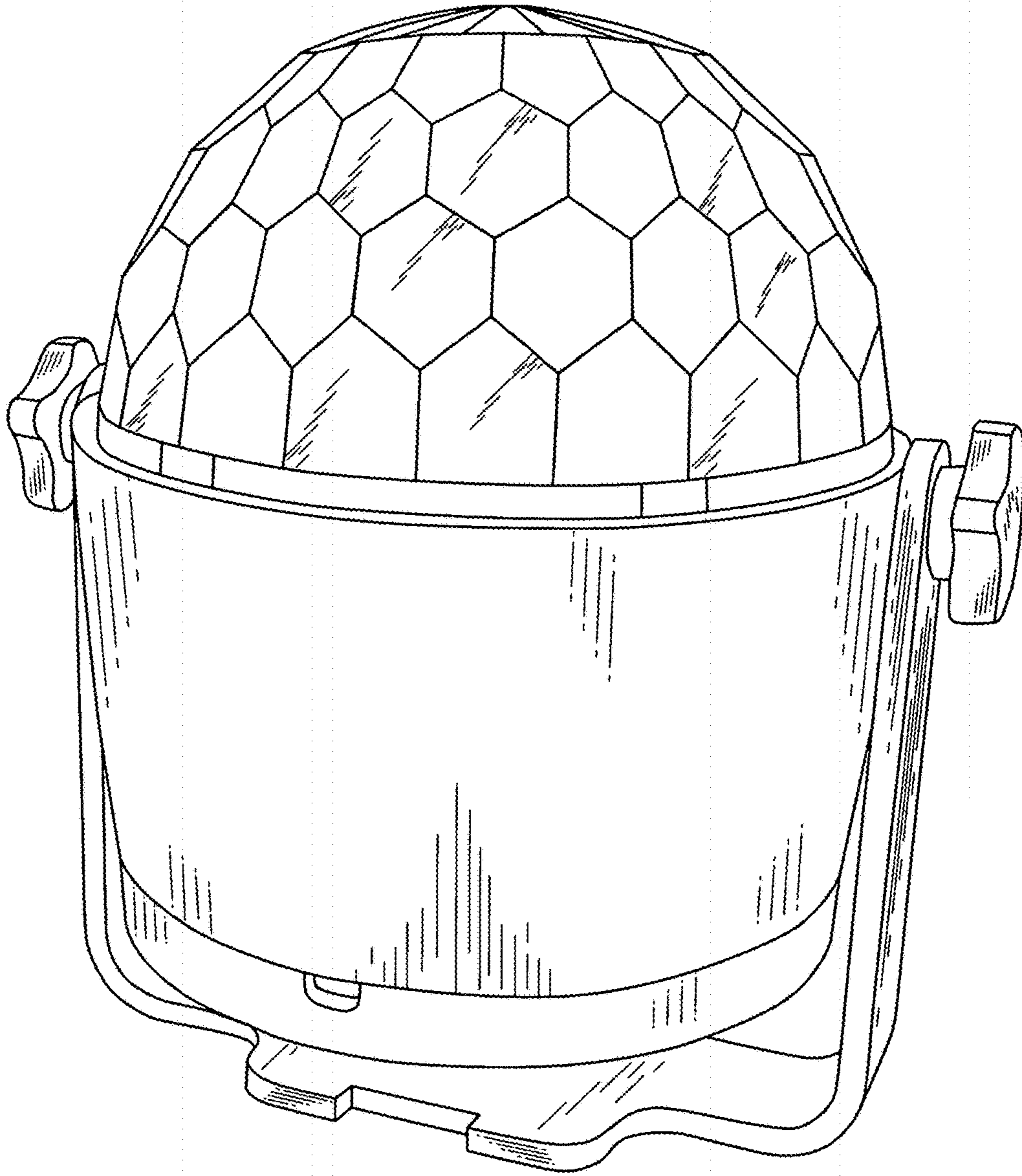

FIG.9