



US00D840916S

(12) **United States Design Patent** (10) **Patent No.:** **US D840,916 S**
Badillo (45) **Date of Patent:** **** Feb. 19, 2019**

- (54) **ROOF RACK INSERT**
- (71) Applicant: **Intelligent Designs 2000 Corp.**,
Aurora, CO (US)
- (72) Inventor: **Paul Badillo**, Littleton, CO (US)
- (73) Assignee: **INTELLIGENT DESIGNS 2000**
CORP., Aurora, CO (US)
- (**) Term: **15 Years**
- (21) Appl. No.: **29/612,930**
- (22) Filed: **Aug. 4, 2017**

2,492,841 A	12/1949	Burkey
2,521,815 A	9/1950	Will
2,663,472 A	12/1953	Belgau
2,784,888 A	3/1957	Lecanu-Deschamps
2,800,264 A	7/1957	McFadyen
2,967,635 A	1/1961	Barnett
3,158,301 A	11/1964	Hedgepeth
3,215,323 A	11/1965	Bonitt
3,260,929 A	7/1966	Hedgepeth
3,330,454 A	7/1967	Bott
3,531,006 A	9/1970	Farchmin
D223,753 S	6/1972	Seals
3,762,587 A	10/1973	Longee, Sr.
3,765,713 A	10/1973	Suitt

(Continued)

Related U.S. Application Data

- (63) Continuation of application No. 29/535,957, filed on Aug. 12, 2015, now Pat. No. Des. 793,946, which is a continuation of application No. 13/942,489, filed on Jul. 15, 2013, now Pat. No. 9,676,343, which is a continuation of application No. 12/861,034, filed on Aug. 23, 2010, now Pat. No. 8,496,146.
- (51) **LOC (11) Cl.** **12-16**
- (52) **U.S. Cl.**
USPC **D12/412**
- (58) **Field of Classification Search**
USPC D12/412, 406, 413, 414, 414.1; D6/552;
D3/304-306
CPC B60R 9/04; B60R 9/048; B60R 9/045
See application file for complete search history.

(56) **References Cited**

U.S. PATENT DOCUMENTS

D30,369 S	3/1899	Mandt
D33,754 S	12/1900	Hien
704,436 A	7/1902	Cluff
744,113 A	11/1903	Rye
1,564,776 A	12/1925	Green
1,606,954 A	11/1926	Moen et al.
2,387,779 A	10/1945	Strauss

OTHER PUBLICATIONS

U.S. Appl. No. 10/948,972, filed Sep. 24, 2004.
(Continued)

Primary Examiner — Katrina A Betton
(74) *Attorney, Agent, or Firm* — Sheridan Ross PC

(57) **CLAIM**

The ornamental design for a roof rack insert, as shown and described.

DESCRIPTION

FIG. 1 is a perspective view of a roof rack insert;
FIG. 2 is a front elevation view thereof;
FIG. 3 is a rear elevation view thereof;
FIG. 4 is a left elevation view thereof;
FIG. 5 is a right elevation view thereof;
FIG. 6 is a top plan view thereof;
FIG. 7 is a bottom plan view thereof; and,
FIG. 8 is a perspective view of the roof rack insert positioned adjacent to a vehicle roof rack.
The broken lines depict unclaimed environmental subject matter and do not form any part of the claimed design.

1 Claim, 4 Drawing Sheets

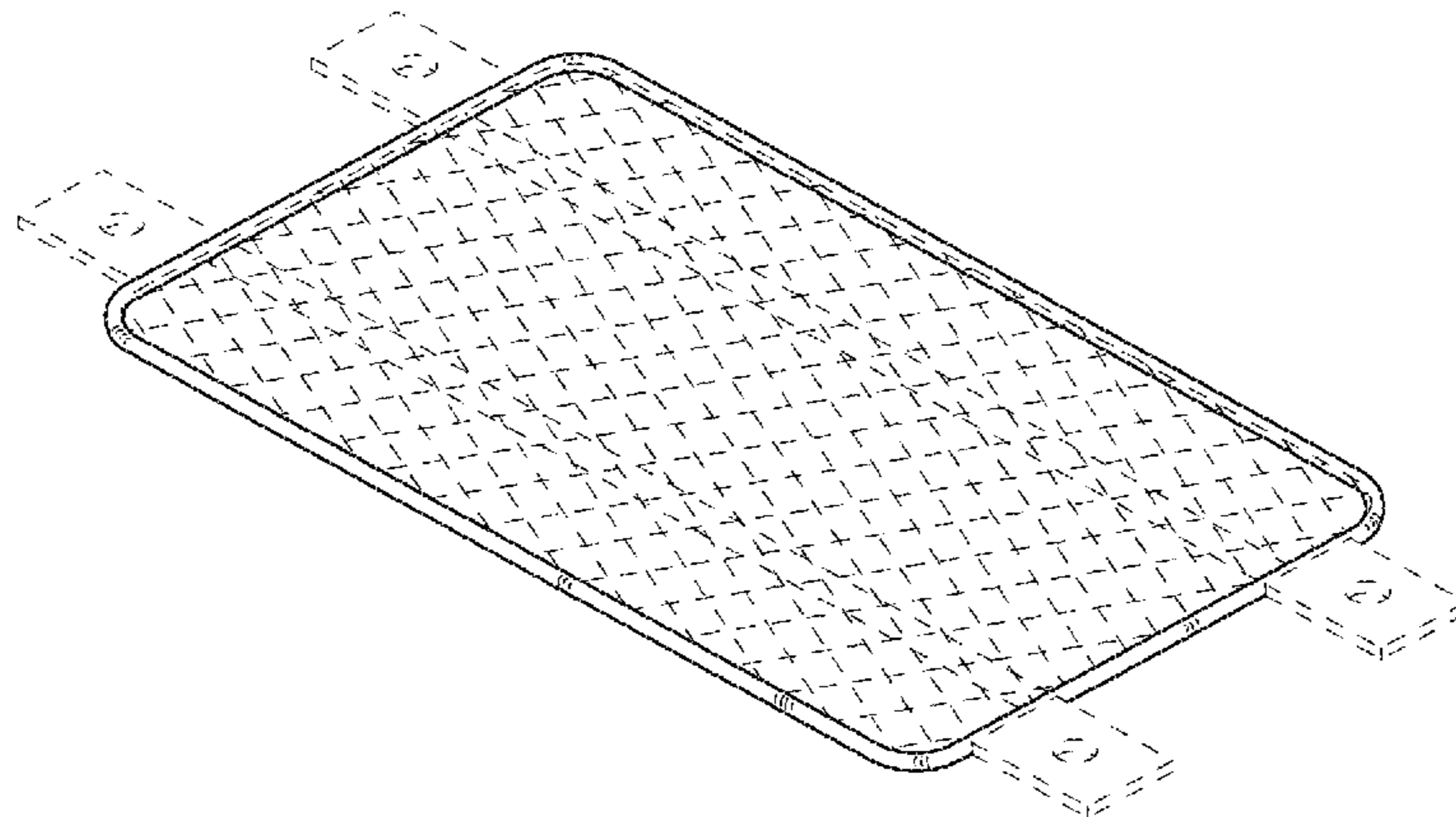

(56)

References Cited

U.S. PATENT DOCUMENTS

3,902,642 A 9/1975 McNeece
 3,905,499 A 9/1975 Speidel
 D243,447 S 2/1977 Smith, III et al.
 4,240,571 A 12/1980 Ernst
 4,249,683 A 2/1981 Park
 4,336,897 A 6/1982 Luck
 4,350,471 A 9/1982 Lehman
 4,817,834 A 4/1989 Weiler
 4,948,024 A 8/1990 Warner et al.
 4,995,538 A 2/1991 Marengo
 D324,664 S 3/1992 Burnette
 5,171,083 A 12/1992 Rich
 5,320,061 A 6/1994 Laughlin et al.
 5,381,939 A 1/1995 Tippets
 D359,134 S 6/1995 Toews
 5,560,525 A 10/1996 Grohmann et al.
 D406,557 S 3/1999 Bentley
 D413,562 S 9/1999 Van Dusen et al.
 6,003,633 A 12/1999 Rolson
 6,015,074 A 1/2000 Snavelly et al.
 D422,553 S 4/2000 VonDuyke
 6,116,378 A 9/2000 Barrow
 6,126,051 A 10/2000 Potter
 D434,364 S 11/2000 Bauer et al.
 6,152,339 A 11/2000 Kreisler
 D434,718 S 12/2000 Kreisler
 D435,510 S 12/2000 Quidort
 6,179,180 B1 1/2001 Walker et al.
 D442,289 S 5/2001 Ziaylek et al.
 6,308,874 B1 10/2001 Kim et al.
 6,425,508 B1 7/2002 Cole et al.
 6,428,263 B1 8/2002 Schellens
 D463,358 S 9/2002 Thomas
 D470,451 S 2/2003 Bushart et al.
 6,561,397 B1 5/2003 Bauer et al.
 6,581,813 B2 6/2003 Bove et al.
 D477,562 S 7/2003 McCoy et al.
 6,604,606 B1 8/2003 McDougal et al.
 D479,884 S 9/2003 Berryman
 D481,003 S 10/2003 Bauer et al.
 6,715,652 B2 4/2004 Kmita et al.
 D490,163 S 5/2004 Thurston
 6,739,349 B2 5/2004 Kastenschmid et al.
 6,755,332 B2 6/2004 Crane et al.
 6,772,928 B2 8/2004 Ford et al.
 D508,015 S 8/2005 Badillo
 D512,783 S 12/2005 Badillo
 D520,938 S 5/2006 Badillo
 7,055,454 B1 6/2006 Whiting et al.
 D537,404 S 2/2007 Bauer et al.
 7,226,226 B2 * 6/2007 Troman B41J 33/04
 347/217
 7,226,266 B2 6/2007 Henderson et al.
 7,249,927 B2 7/2007 Wooten et al.
 D549,838 S 8/2007 Badillo
 D558,123 S 12/2007 Murillo
 D564,419 S 3/2008 Clontz
 D578,952 S * 10/2008 Badillo D12/406
 D603,321 S * 11/2009 Kramer D12/412
 D621,328 S 8/2010 Sistare et al.
 D624,005 S 9/2010 Winner et al.
 D638,333 S 5/2011 Freeman
 D650,316 S 12/2011 Pirolo et al.
 8,496,146 B2 7/2013 Badillo
 D765,577 S 9/2016 Kmita et al.
 D772,783 S 11/2016 Schleef
 9,676,343 B2 6/2017 Badillo
 D793,946 S 8/2017 Badillo
 D815,012 S * 4/2018 Badillo D12/412
 D825,924 S * 8/2018 Tuang D3/306
 2005/0082326 A1 * 4/2005 Badillo B60R 9/00
 224/326

2005/0092796 A1 * 5/2005 Essig B60R 9/00
 224/321
 2005/0095102 A1 5/2005 Watson
 2011/0101056 A1 * 5/2011 Barkey B60R 9/052
 224/321

OTHER PUBLICATIONS

U.S. Appl. No. 29/303,917, filed Feb. 20, 2008 now U.S. Pat. No. D. 578,952.
 U.S. Appl. No. 29/177,928, filed Mar. 17, 2003 now U.S. Pat. No. D. 508,015.
 U.S. Appl. No. 29/233,827, filed Jul. 8, 2005 now U.S. Pat. No. D. 520,938.
 U.S. Appl. No. 29/183,072, filed Jun. 4, 2003 now U.S. Pat. No. D. 512,783.
 U.S. Appl. No. 29/246,929, filed May 22, 2006 now U.S. Pat. No. D. 549,838.
 U.S. Appl. No. 12/861,034, filed Aug. 23, 2010 now U.S. Pat. No. 8,496,146.
 U.S. Appl. No. 13/942,489, filed Jul. 15, 2013 now U.S. Pat. No. 9,676,343.
 U.S. Appl. No. 29/535,865, filed Aug. 11, 2015.
 U.S. Appl. No. 29/535,957, filed Aug. 12, 2015 now U.S. Pat. No. D. 793,946.
 U.S. Appl. No. 29/612,929, filed Aug. 4, 2017.
 U.S. Appl. No. 29/612,927, filed Aug. 4, 2017.
 U.S. Appl. No. 29/612,924, filed Aug. 4, 2017.
 U.S. Appl. No. 15/586,769, filed May 4, 2017.
 U.S. Appl. No. 29/535,865, filed Aug. 11, 2015, Badillo.
 U.S. Appl. No. 15/586,769, filed May 4, 2017, Badillo.
 U.S. Appl. No. 29/612,924, filed Aug. 4, 2017, Badillo.
 U.S. Appl. No. 29/612,927, filed Aug. 4, 2017, Badillo.
 U.S. Appl. No. 29/612,929, filed Aug. 4, 2017, Badillo.
 Advertisement: Yakima Spare Tire Carrier, Cargo Basket for Roof Racks, available at http://www.rackoutfitters.com/catalog/yakima_spare_tire_carrier_1836640.htm, dated Jul. 7, 2003, 1 page.
 Advertisement: Thule 840-Playpen Basket, Cargo Basket for Roof Racks, available at http://www.rackoutfitters.com/catalog/thule_840_-_playpen_basket_1885452.htm, dated Jul. 7, 2003, 1 page.
 Advertisement: SURCO, Products, Inc., "Basket rack-it just flat out carries what you need to take," available at http://www.everythingsuv.com/surco_safari_roof_racks-esuv.asp, dated Jul. 7, 2003, 10 pages.
 Advertisement: KargoMaster, Kargo Master Safari Racks, available at http://www.kargomaster.com/jeep23.asp?rack=sport_jeep, Jul. 7, 2007, 1 page.
 Advertisement: KargoMaster, The Bushman Steel Rack, available at <http://www.kargomaster.com/bushman.asp?type=Jeep>, dated Jul. 7, 2003, 1 page.
 Advertisement: KargoMaster, Seregenti Telescoping Steel Rack, available at <http://www.kargomaster.com/seregenti.asp?type=Jeep>, dated Jul. 7, 2003, 1 page.
 Advertisement: Bauer Vehicle Gear Roof Racks, Roof Storage, Bike Storage & Pet Barriers from Eve, available at http://www.everythingsuv.com/bvg_products-esuv.asp, Jul. 7, 2003, 2 pages.
 Advertisement: Manik Original Off-Road Equipment, Hummer Rough Terrain Package New Product Release "Tilt-Forward 1-Piece Front Bar," 2002, 1 page.
 Advertisement: Manik Original Off-Road Equipment, Hummer Rough Terrain Package New Product Release "Combination Tube Step Rocker Bar," 2002, 1 page.
 Advertisement: Congo Cage Jeep Rack, available at <http://www.kargomaster.com/item.asp?id=62>, printed Apr. 17, 2009, 13 pages.
 Product Literature entitled, "921-Dave's Rack 921-12X," Olympic 4X4, date unknown, 10 pages.
 Advertisement: 921—Daves Rack, Olympic 4X4 Products for over 60 years, available at <http://olympic4x4products.com/utility-racks/921-daves-rack>, printed Jan. 14, 2011, 3 pages.
 "Installation Guide: BR-JPTJ2D-1-0 BajaRack JEEP TJ 2 Doors," BajaRack Adventure Equipment, 4 page, first sold 2013.
 "BR-JPJK-Series Installation Instructions," BajaRack Adventure Equipment, 5 pages, first sold 2013.
 "Installation Guide: BR-JP-JK4D-1-0 BajaRack JEEP JK 4 Doors," BajaRack Adventure Equipment, 6 pages, first sold 2013.

(56)

References Cited

OTHER PUBLICATIONS

Official Action for U.S. Appl. No. 12/861,034 dated Oct. 4, 2012, 16 pages.

Notice of Allowance for U.S. Appl. No. 12/861,034 dated Mar. 29, 2013, 7 pages.

Official Action for U.S. Appl. No. 13/942,489 dated May 3, 2016, 11 pages.

Final Action for U.S. Appl. No. 13/942,489 dated Sep. 29, 2016, 15 pages.

Notice of Allowance for U.S. Appl. No. 13/942,489 dated Feb. 7, 2017, 5 pages.

Official Action for U.S. Appl. No. 29/535,865 dated Aug. 23, 2016, 5 pages.

Final Action for U.S. Appl. No. 29/535,865 dated Feb. 2, 2017, 8 pages.

Notice of Allowance for U.S. Appl. No. 29/535,957 dated Mar. 27, 2017, 6 pages.

Official Action for U.S. Appl. No. 15/586,769 dated Jul. 17, 2017 14 pages.

Official Action for U.S. Appl. No. 29/535,865, dated Nov. 3, 2017 10 pages.

Official Action for U.S. Appl. No. 15,586,769, dated Dec. 5, 2017 9 pages.

U.S. Appl. No. 29/640,814, filed Mar. 16, 2018, Badillo.

Official Action for U.S. Appl. No. 29/535,865, dated Jun. 28, 2018, 9 pages.

Official Action for U.S. Appl. No. 15/586,769, dated Jun. 26, 2018, 8 pages.

Official Action for U.S. Appl. No. 15/344,244, dated Jun. 21, 2018, 11 pages.

* cited by examiner

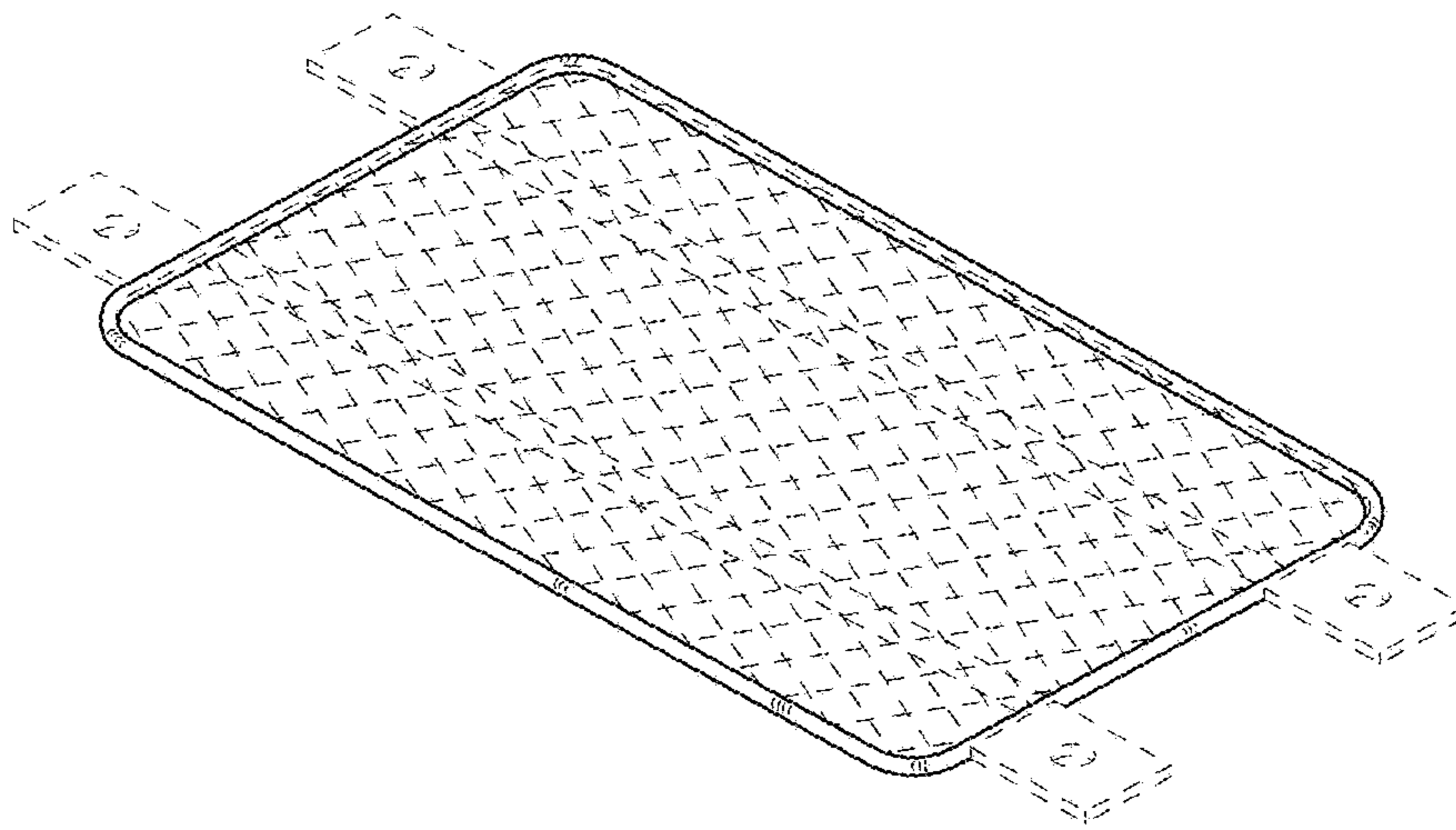

FIG. 1

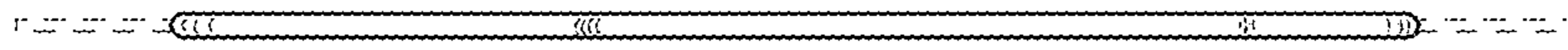

FIG. 2

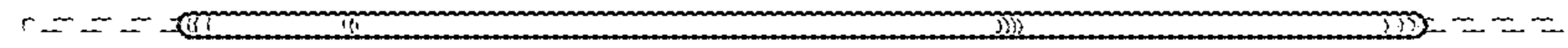

FIG. 3

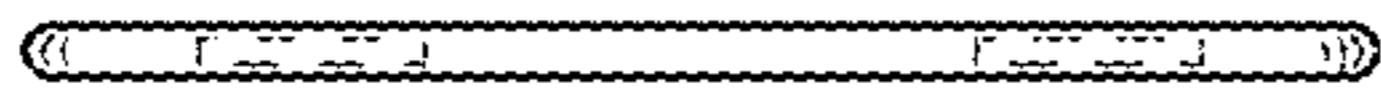

FIG. 4

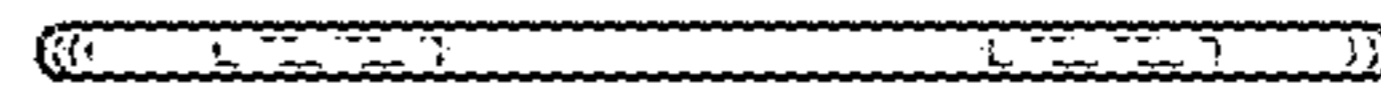

FIG. 5

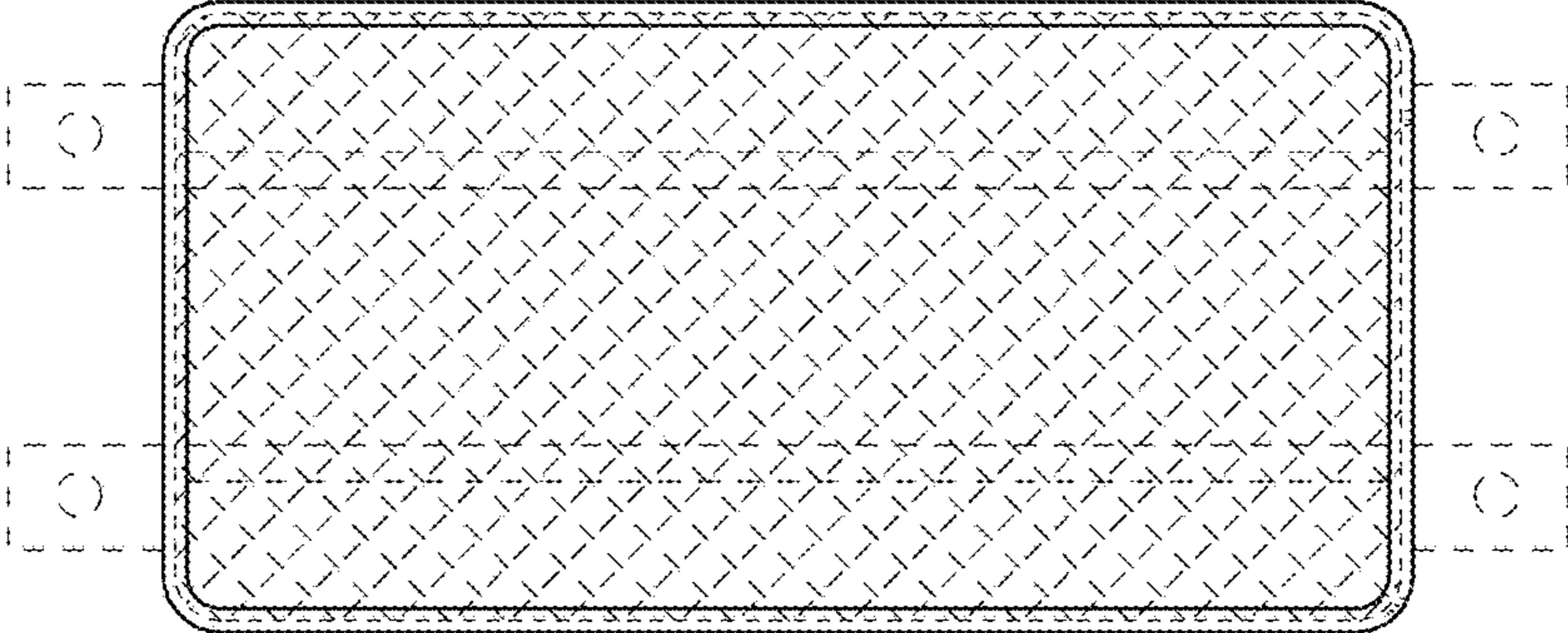

FIG.6

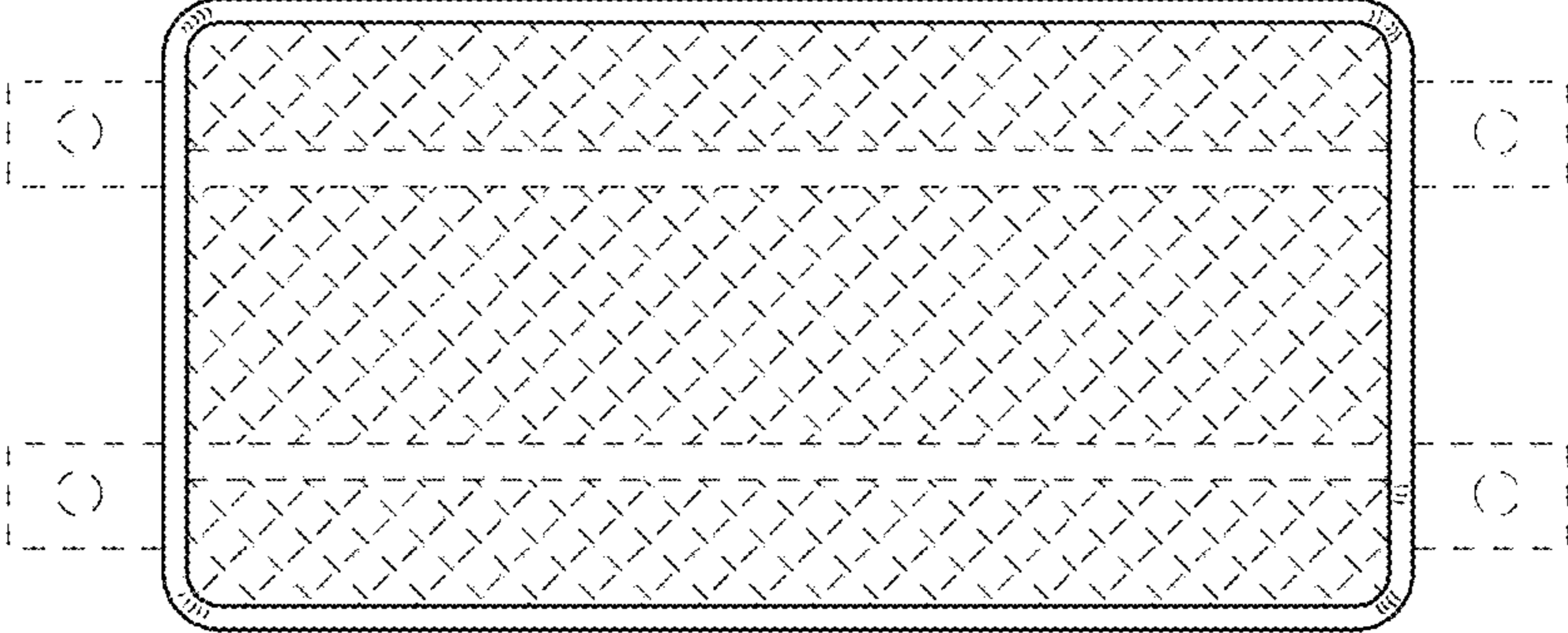

FIG.7

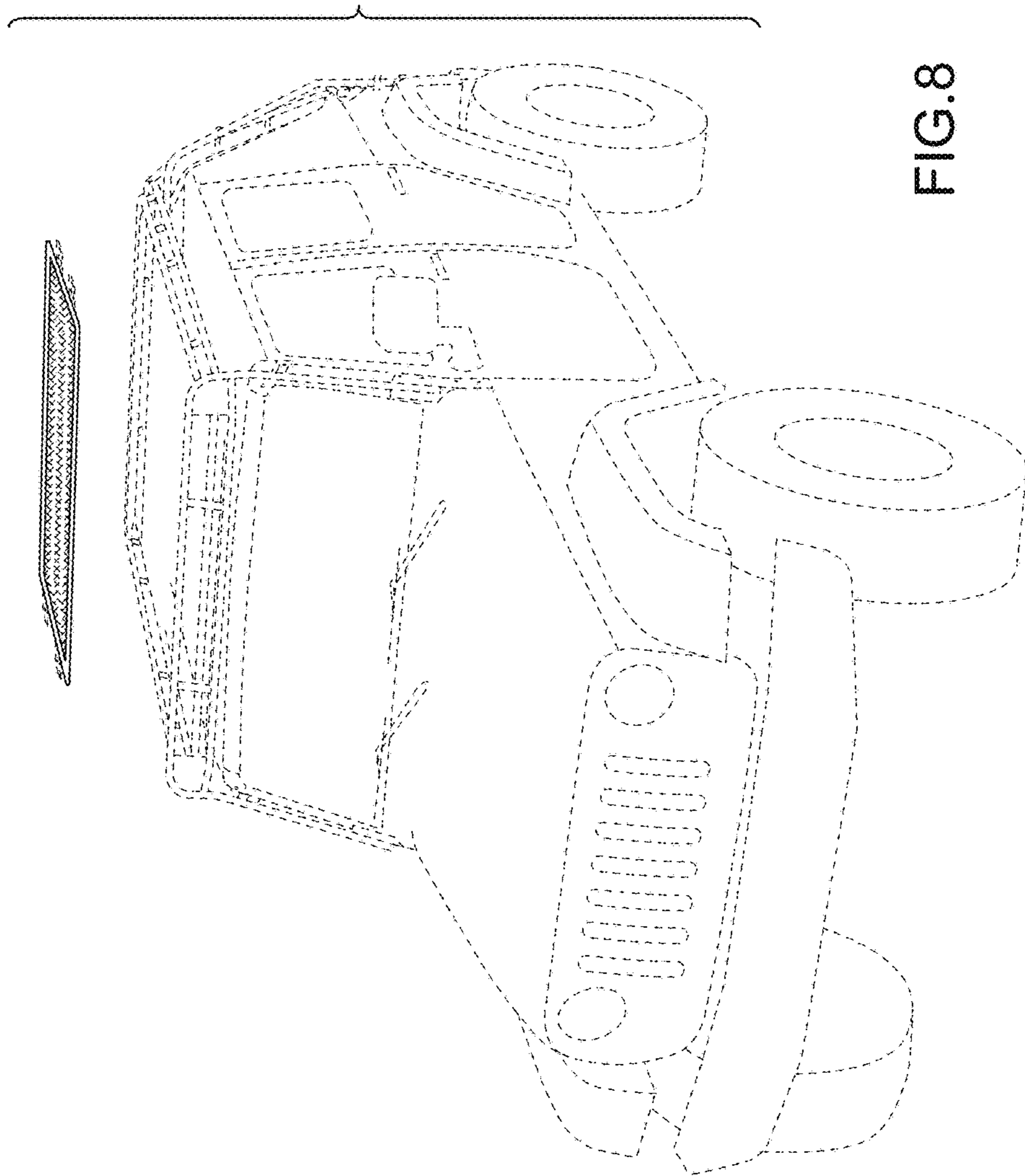

FIG. 8