

US00D840873S

(12) **United States Design Patent**  
**Nurnberger et al.**

(10) **Patent No.:** **US D840,873 S**

(45) **Date of Patent:** **\*\* Feb. 19, 2019**

(54) **AUTOMOBILE AND/OR REPLICA THEREOF**

(71) Applicant: **ASTON MARTIN LAGONDA LIMITED**, Warwick (GB)

(72) Inventors: **Miles Nurnberger**, Warwick (GB);  
**Julian Nunn**, Warwick (GB)

(73) Assignee: **Aston Martin Lagonda Limited** (GB)

(\*\*) Term: **15 Years**

(21) Appl. No.: **29/621,813**

(22) Filed: **Oct. 11, 2017**

(30) **Foreign Application Priority Data**

Apr. 13, 2017 (EM) ..... 003856111-0001

(51) **LOC (11) Cl.** ..... **12-08**

(52) **U.S. Cl.**  
USPC ..... **D12/92**

(58) **Field of Classification Search**  
USPC ..... D12/86, 90-92; D21/424, 433, 434;  
296/181.1-181.5, 183.1  
CPC ..... B62D 25/00; B62D 25/06; B62D 33/00;  
B62D 35/00  
See application file for complete search history.

(56) **References Cited**

**U.S. PATENT DOCUMENTS**

D620,396 S	7/2010	Reichman et al.	
D626,466 S	11/2010	Reichman et al.	
D629,718 S	12/2010	Reichman et al.	
D629,719 S	12/2010	Reichman et al.	
D629,725 S	12/2010	Reichman et al.	
D630,140 S	1/2011	Reichman et al.	
D670,640 S	11/2012	Reichman et al.	
D687,348 S *	8/2013	Nurnberger	D12/92
D689,812 S	9/2013	Reichman et al.	
D692,800 S *	11/2013	Wiltshire	D12/92
D698,283 S *	1/2014	Palm	D12/92

D704,102 S *	5/2014	Nurnberger	D12/92
D704,601 S	5/2014	Nurnberger	
D726,079 S	4/2015	Reichman et al.	
D727,804 S *	4/2015	Nurnberger	D12/163
D730,777 S	6/2015	Nurnberger	
D739,789 S	9/2015	Payne	
D740,725 S	10/2015	Payne	

(Continued)

**OTHER PUBLICATIONS**

U.S. Appl. No. 29/542,940, filed Oct. 19, 2015, Kahn.

(Continued)

*Primary Examiner* — Melody N Brown

(74) *Attorney, Agent, or Firm* — Dorsey & Whitney LLP

(57) **CLAIM**

The ornamental design for an automobile and/or replica thereof, as shown and described.

**DESCRIPTION**

FIG. 1 is a front elevation view of an automobile and/or replica thereof in accordance with the present design; FIG. 2 is a rear elevation view thereof; FIG. 3 is a right side elevation view thereof, the left side elevation view being a mirror image thereof except for the presence of a fuel access door shown in broken line in FIG. 4;

FIG. 4 is a top plan view thereof;

FIG. 5 is a front perspective view thereof; and,

FIG. 6 is a rear perspective view thereof.

The broken lines show portions of the automobile and/or replica thereof that form no part of the claimed design.

Any combination of the illustrated features may be claimed in this application or a continuing application claiming priority to this application by converting any of the solid lines to broken lines, any of the broken lines to solid lines, or any combination thereof.

**1 Claim, 5 Drawing Sheets**

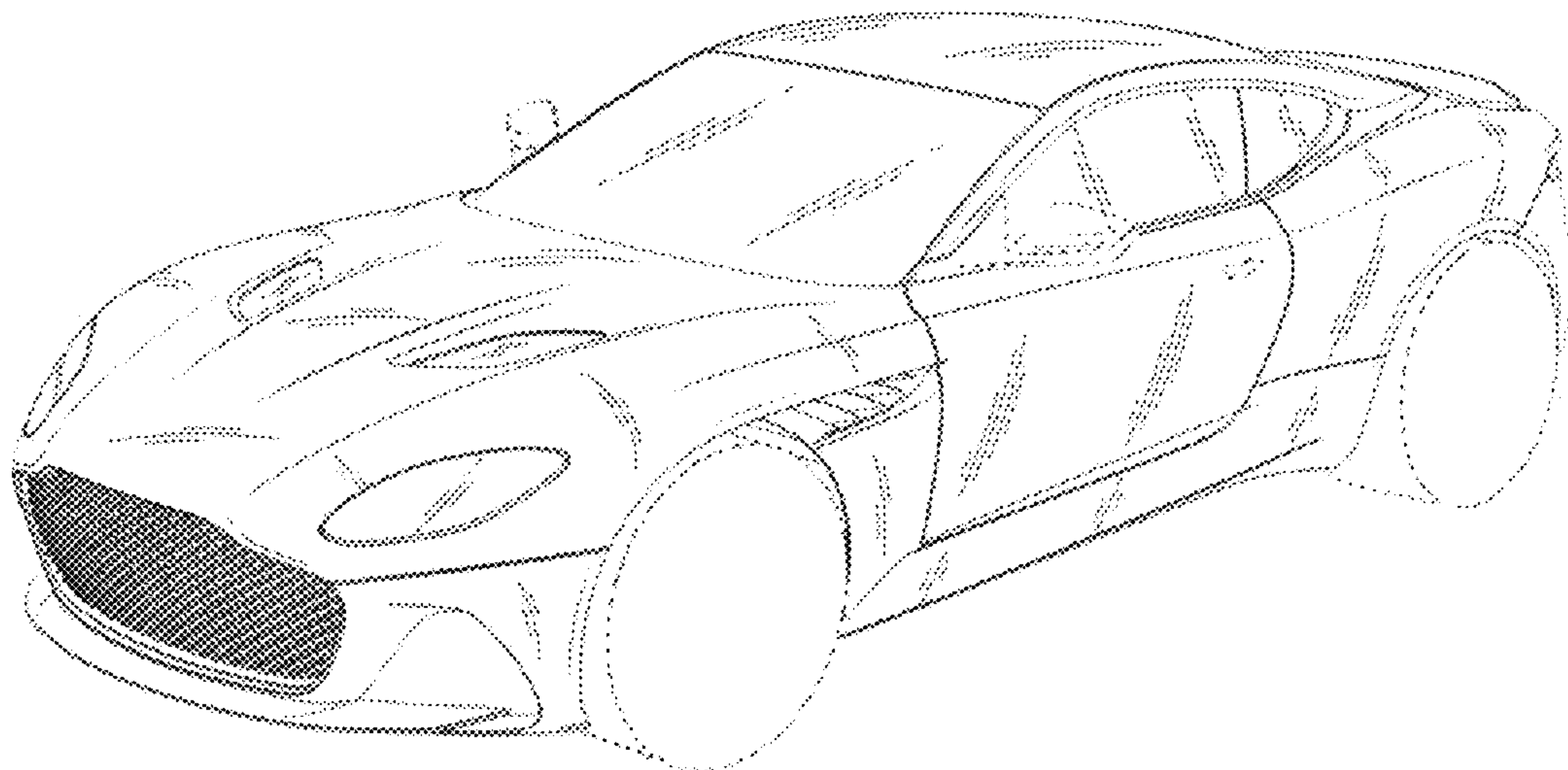

(56)

**References Cited**

U.S. PATENT DOCUMENTS

D758,247 S 6/2016 Nurnberger et al.  
 D766,474 S 9/2016 Holgate et al.  
 D772,128 S 11/2016 Platt  
 D774,950 S \* 12/2016 Holgate ..... D12/92  
 D774,995 S 12/2016 Holgate et al.  
 D777,070 S 1/2017 Nurnberger  
 D778,790 S 2/2017 Nurnberger  
 D780,632 S 3/2017 Nurnberger  
 D780,633 S 3/2017 Nurnberger et al.  
 D780,634 S 3/2017 Nurnberger et al.  
 D780,636 S 3/2017 Kahn  
 D785,525 S 5/2017 Nurnberger  
 D786,155 S 5/2017 Holgate et al.  
 D786,744 S 5/2017 Nurnberger et al.  
 D796,404 S 9/2017 Nurnberger  
 D800,619 S 10/2017 Platt  
 D801,558 S 10/2017 Nurnberger et al.  
 D820,164 S \* 6/2018 Nurnberger ..... D12/92  
 D825,387 S \* 8/2018 Nurnberger ..... D12/92

OTHER PUBLICATIONS

U.S. Appl. No. 29/573,909, filed Aug. 10, 2016, Cooper.  
 U.S. Appl. No. 29/582,156, filed Oct. 25, 2016, Earley.  
 U.S. Appl. No. 29/582,165, filed Oct. 25, 2016, Earley.  
 U.S. Appl. No. 29/582,167, filed Oct. 25, 2016, Earley.  
 U.S. Appl. No. 29/582,170, filed Oct. 25, 2016, Earley.  
 U.S. Appl. No. 29/583,268, filed Nov. 3, 2016, Nurnberger et al.

U.S. Appl. No. 29/583,272, filed Nov. 3, 2016, Nurnberger et al.  
 U.S. Appl. No. 29/583,278, filed Nov. 3, 2016, Nurnberger et al.  
 U.S. Appl. No. 29/584,625, filed Nov. 16, 2016, Nurnberger et al.  
 U.S. Appl. No. 29/584,629, filed Nov. 16, 2016, Nurnberger et al.  
 U.S. Appl. No. 29/589,582, filed Jan. 3, 2017, Nurnberger et al.  
 U.S. Appl. No. 29/589,583, filed Jan. 3, 2017, Nurnberger et al.  
 U.S. Appl. No. 29/589,586, filed Jan. 3, 2017, Nurnberger et al.  
 U.S. Appl. No. 29/589,618, filed Jan. 3, 2017, Nurnberger et al.  
 U.S. Appl. No. 29/589,621, filed Jan. 3, 2017, Nurnberger et al.  
 U.S. Appl. No. 29/595,005, filed Feb. 24, 2017, Nurnberger et al.  
 U.S. Appl. No. 29/604,102, filed May 15, 2017, Nurnberger et al.  
 U.S. Appl. No. 29/616,003, filed Sep. 1, 2017, Re et al.  
 U.S. Appl. No. 29/616,006, filed Sep. 1, 2017, Re et al.  
 U.S. Appl. No. 29/616,008, filed Sep. 1, 2017, Re et al.  
 U.S. Appl. No. 29/616,010, filed Sep. 1, 2017, Re et al.  
 U.S. Appl. No. 29/616,014, filed Sep. 1, 2017, Re et al.  
 U.S. Appl. No. 29/621,815, filed Oct. 11, 2017, Nurnberger et al.  
 U.S. Appl. No. 29/626,411, filed Nov. 16, 2017, Nurnberger et al.  
 U.S. Appl. No. 29/626,415, filed Nov. 16, 2017, Nurnberger et al.  
 U.S. Appl. No. 29/626,419, filed Nov. 16, 2017, Hill et al.  
 U.S. Appl. No. 29/626,801, filed Nov. 20, 2017, Hill et al.  
 U.S. Appl. No. 29/631,883, filed Jan. 3, 2018, Hill et al.  
 U.S. Appl. No. 29/631,887, filed Jan. 3, 2018, Hill et al.  
 Aston Martin 2013, "Aston Martin Centenary Celebration Programme," 2013; 204 pages.  
 1976 and 1987 Aston Martin Lagonda, [online], [site visited Jul. 24, 2014], Available from Internet, <URL: <http://www.astonmartin.com/heritage/past-models/lagonda>>, 2 pages.

\* cited by examiner



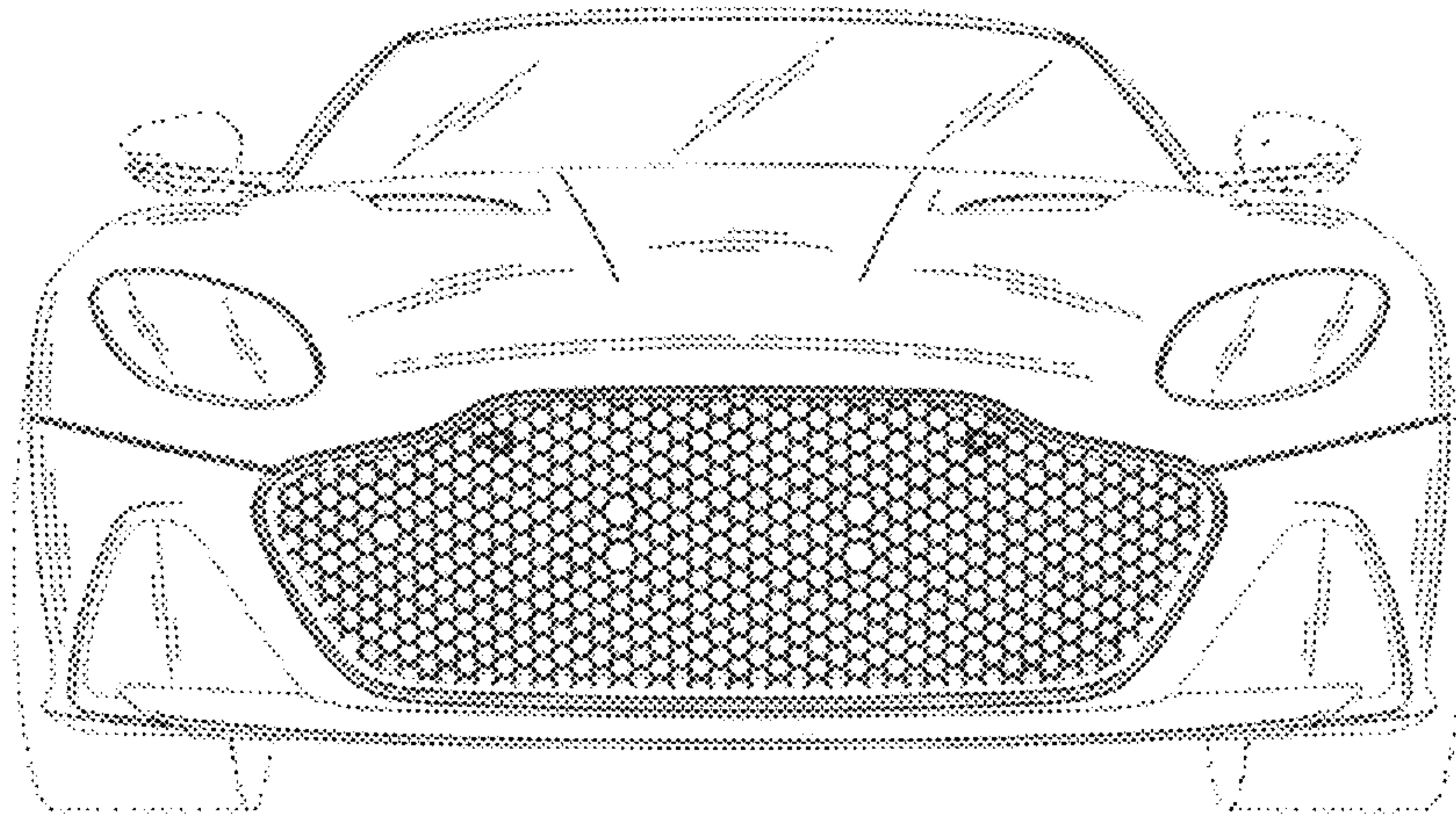

Fig. 1

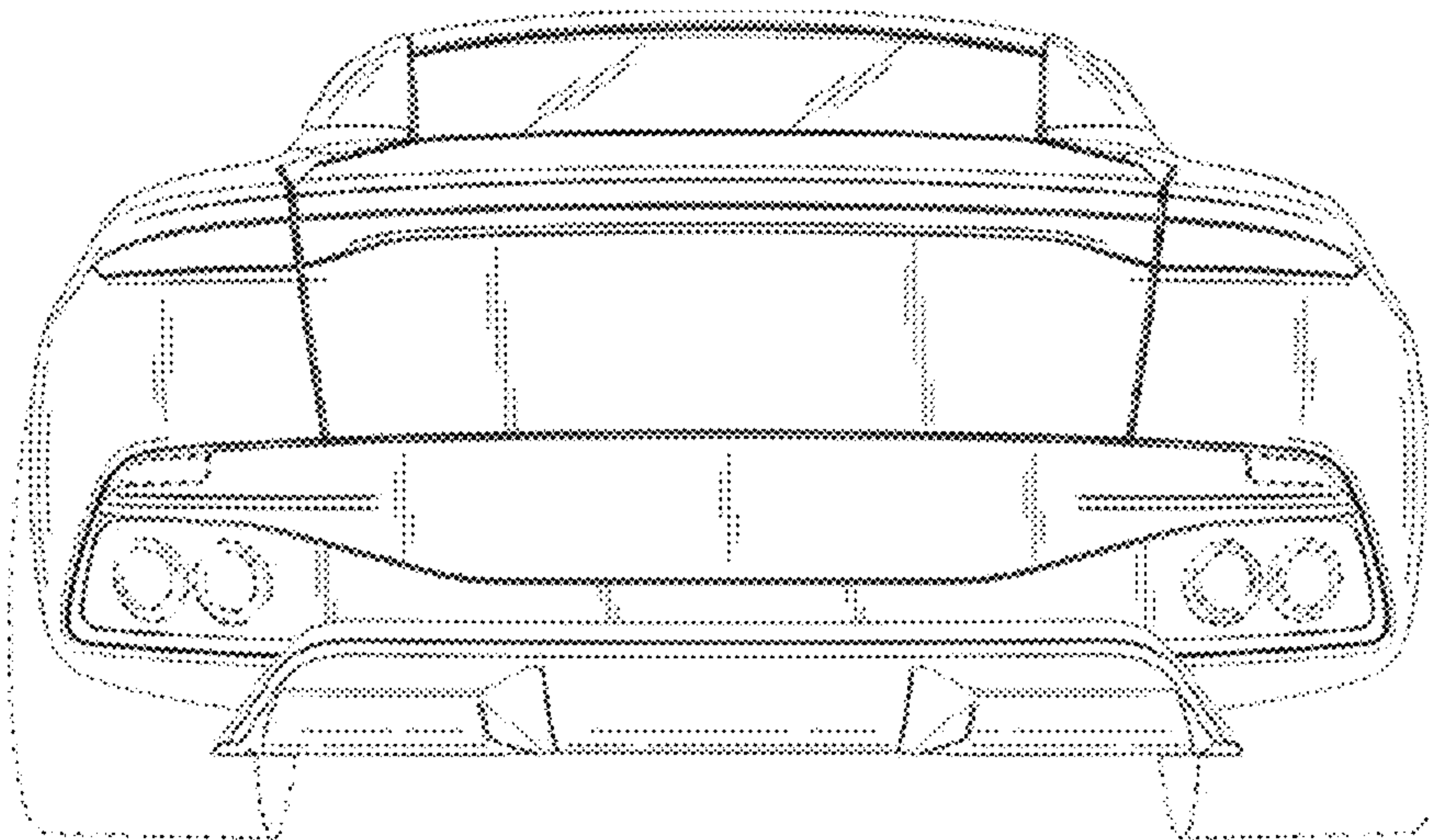

Fig. 2

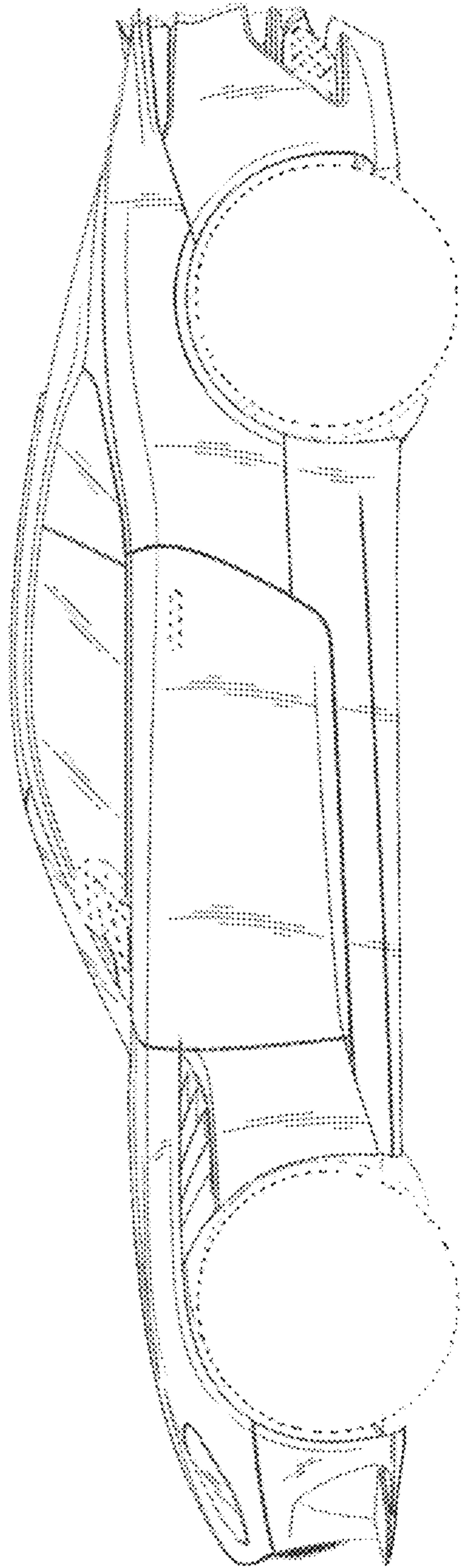

Fig. 3

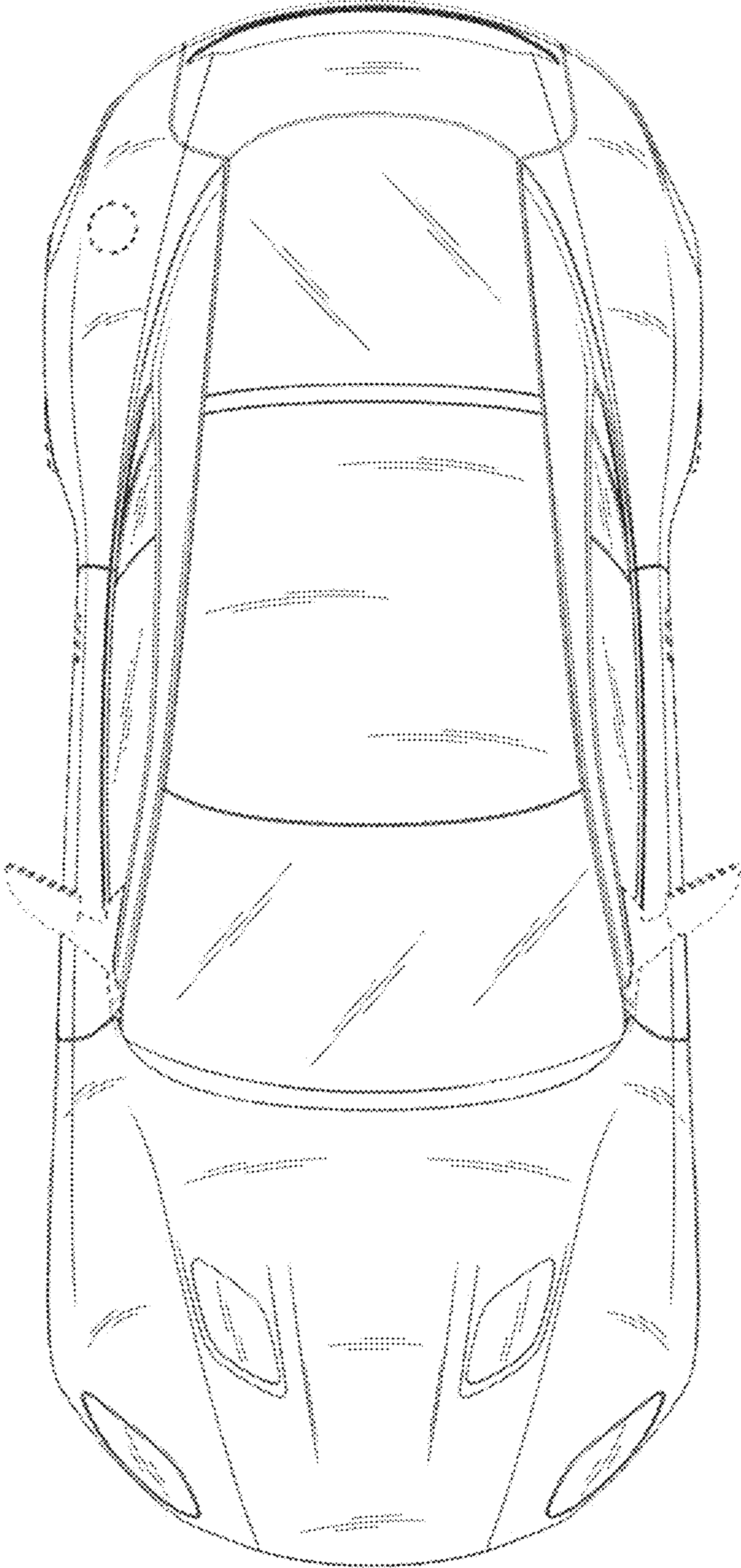

Fig. 4



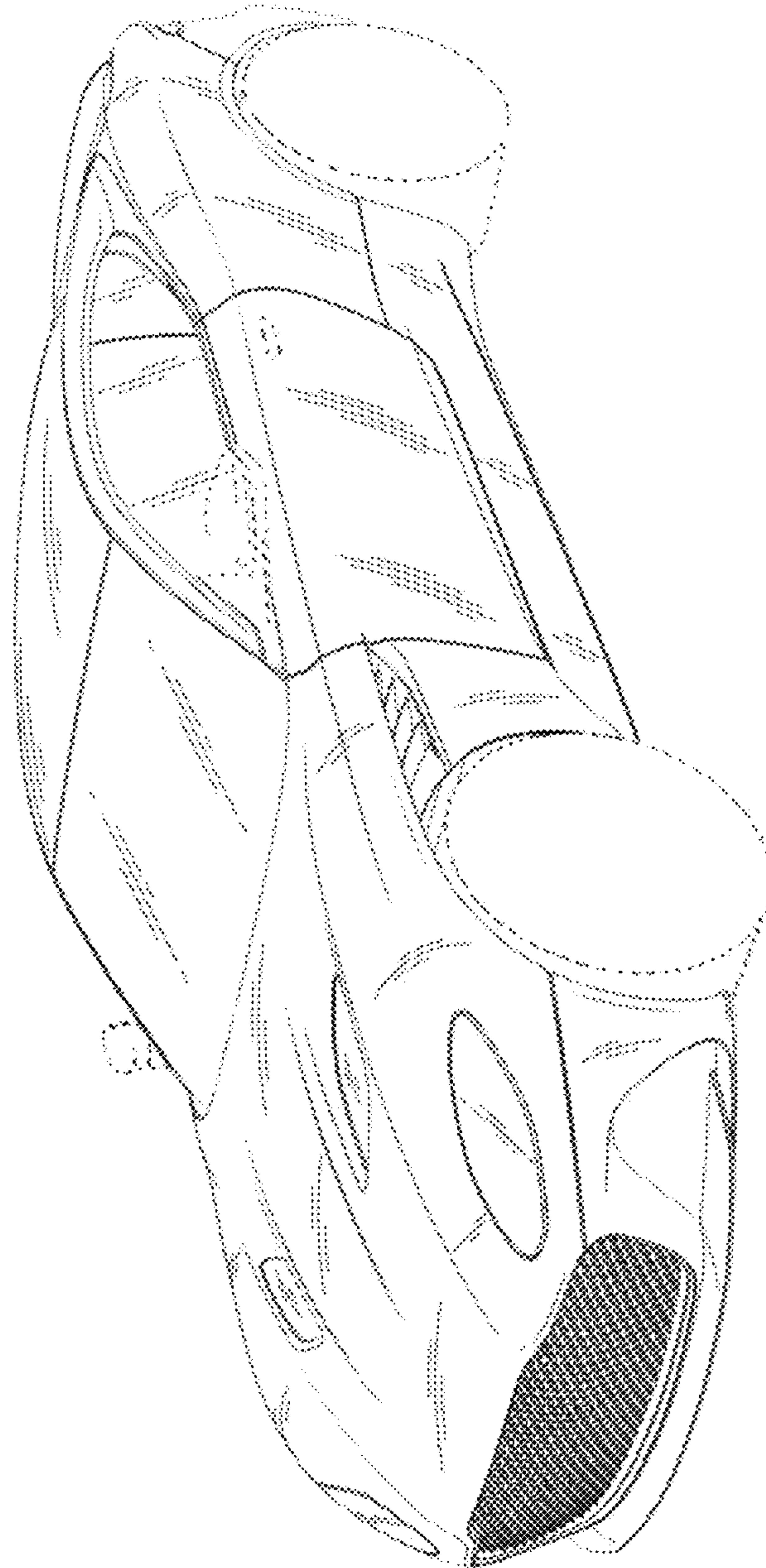

Fig. 5

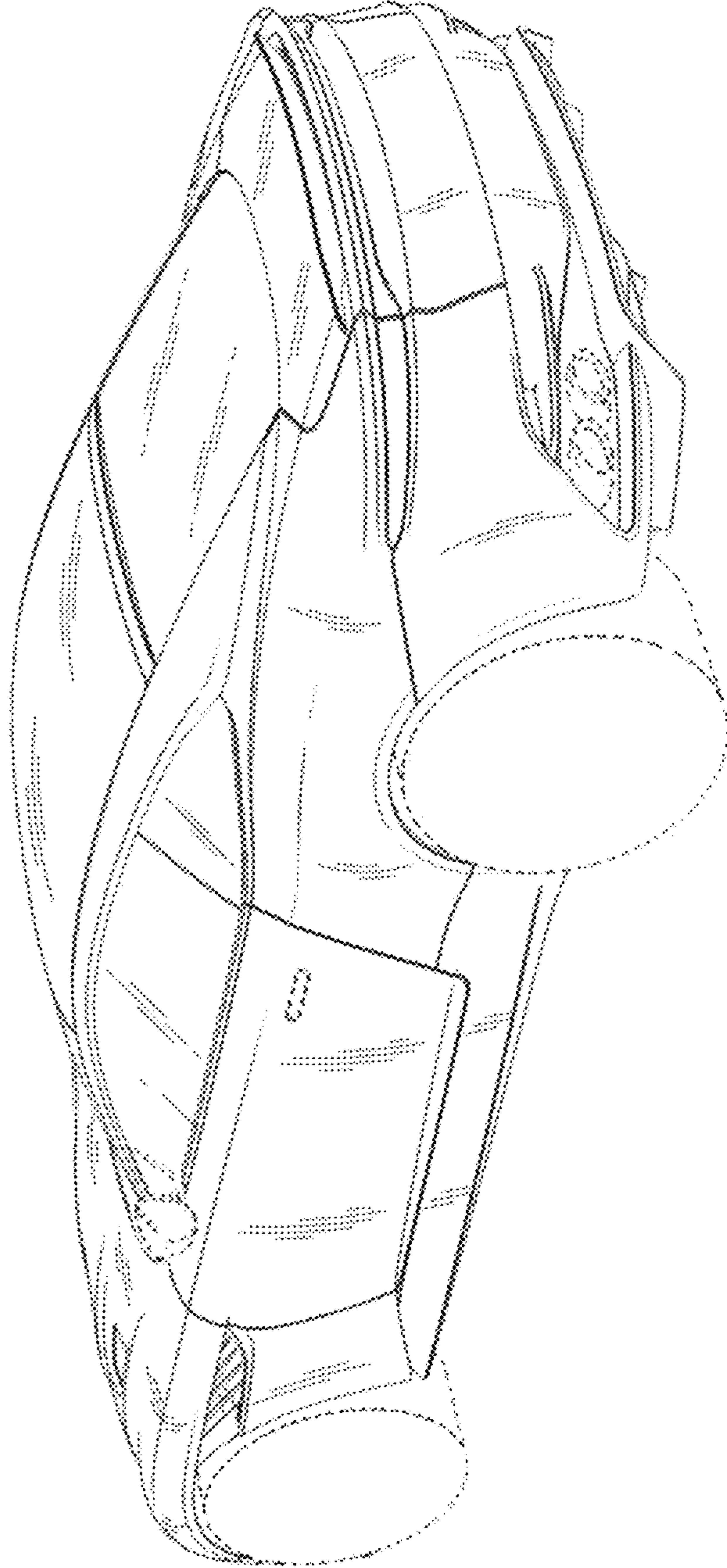

Fig. 6