



US00D840862S

(12) **United States Design Patent** (10) **Patent No.:** **US D840,862 S**
Neeley (45) **Date of Patent:** **** Feb. 19, 2019**

(54) **RING**
(71) Applicant: **Gregory Neeley**, Austin, TX (US)
(72) Inventor: **Gregory Neeley**, Austin, TX (US)
(**) Term: **15 Years**
(21) Appl. No.: **29/573,883**
(22) Filed: **Aug. 10, 2016**
(51) **LOC (11) Cl.** **11-01**
(52) **U.S. Cl.**
USPC **D11/34**
(58) **Field of Classification Search**
USPC ... D11/1-4, 7, 8, 16, 17, 20, 22, 24, 26, 28,
D11/29, 34, 35, 36, 37, 38, 39
CPC ... A44C 9/0007; A44C 9/0015; A44C 9/0023;
A44C 9/0046; A44C 13/00; A44C
17/0225; A44C 17/0208; A44C 17/0241
See application file for complete search history.

(56) **References Cited**

U.S. PATENT DOCUMENTS

D443,222	S	*	6/2001	Cabarbaye	D11/26
D563,821	S	*	3/2008	McKeever	D11/26
D576,909	S	*	9/2008	McKeever	D11/26
D600,155	S	*	9/2009	Canova	D11/34
D606,895	S	*	12/2009	Lebail	D11/34
D612,283	S	*	3/2010	Gruosi	D11/26
D624,450	S	*	9/2010	Maier	D11/26
D626,025	S	*	10/2010	Iacomucci	D11/26
D631,382	S	*	1/2011	Iacomucci	D11/26
D663,649	S	*	7/2012	Gruosi	D11/26
D665,296	S	*	8/2012	Fillon	D11/26
D794,494	S	*	8/2017	Morin	D11/26
D794,495	S	*	8/2017	Morin	D11/26
D810,607	S	*	2/2018	Marchand	D11/34
D817,215	S	*	5/2018	Wempe	D11/35

OTHER PUBLICATIONS

Diamond Crossover Ring (available online) Retrieved from the internet Jan. 26, 2018, retrieved frmo URL: <https://www.pinterest.com/pin/258816309812515849/>.*

Crossover Statement Ring (available online May 6, 2016) Retrieved from the internet Jan. 26, 2018, retrieved frmo URL: https://www.amazon.com/FAPPAC-Crossover-Statement-Enriched-Swarovski/dp/B01FH0LP2O/ref=sr_1_102?ie=UTF8&qid=1516985512&sr=8-102&keywords=crossover+ring.*

(Continued)

Primary Examiner — Kevin K Rudzinski

Assistant Examiner — Richard Kearney

(74) *Attorney, Agent, or Firm* — Hulsey P.C.

(57) **CLAIM**

The ornamental design for a ring, as shown and described.

DESCRIPTION

FIG. 1 shows a side perspective view of a first embodiment of a ring showing my new design;
FIG. 2 shows a front, top perspective view thereof;
FIG. 3 shows a right side view thereof;
FIG. 4 shows a left side view thereof;
FIG. 5 shows a front side view thereof;
FIG. 6 shows a rear side view of thereof;
FIG. 7 shows a top view thereof;
FIG. 8 shows a bottom view thereof;
FIG. 9 shows a side perspective view of a second embodiment of the ring;
FIG. 10 shows a front, top perspective view thereof;
FIG. 11 shows a right side view thereof;
FIG. 12 shows a left side view thereof;
FIG. 13 shows a front side view thereof;
FIG. 14 shows a rear side view thereof;
FIG. 15 shows a top view thereof; and,
FIG. 16 shows a bottom view thereof.
The broken lines shown in the drawings illustrate portions of the article that form no part of the claimed design.

1 Claim, 16 Drawing Sheets

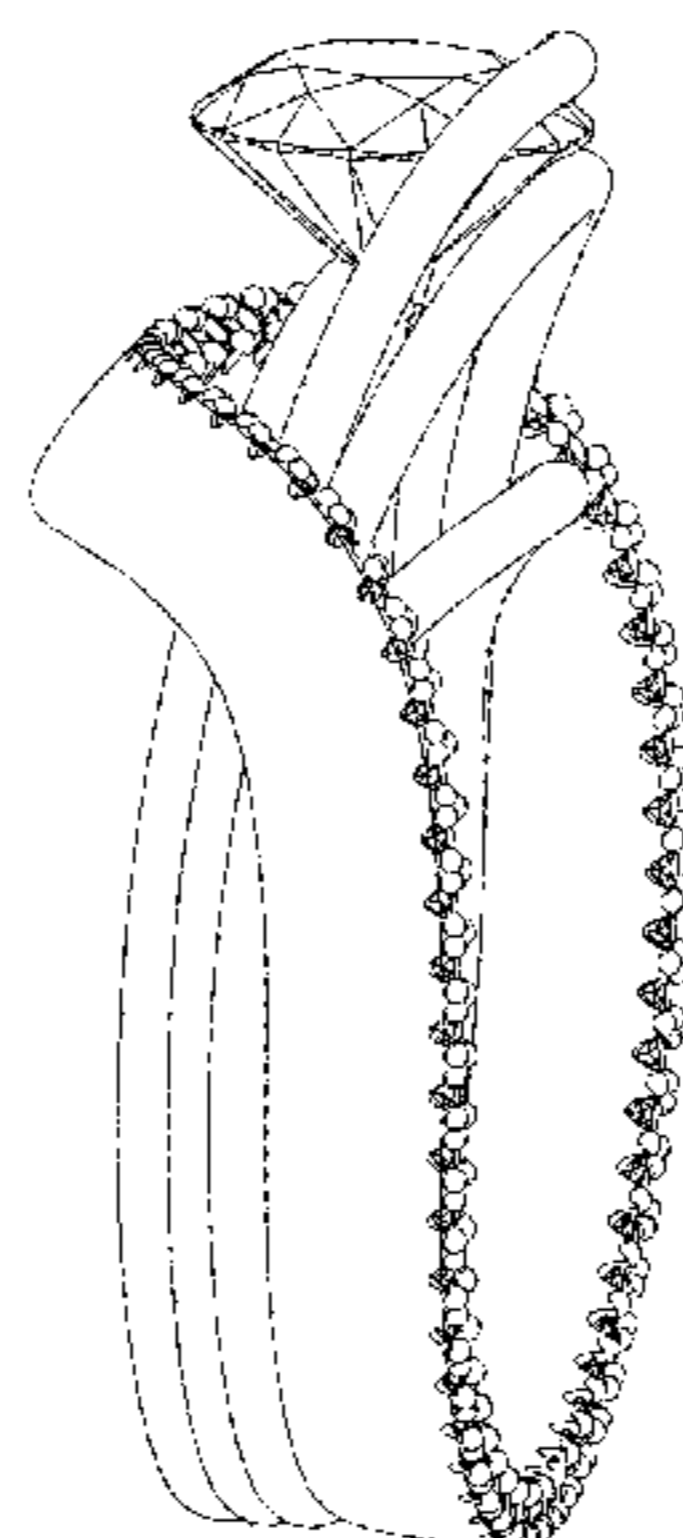

(56)

References Cited

OTHER PUBLICATIONS

Greg Neeley Austin 1 Engagement Ring (available online) Retrieved from the internet Jan. 26, 2018, retrieved from URL: <http://www.gregneeleydesign.com/austin1-engagement-ring>.*

Multi Band Crossover Ring (available online) Retrieved from the internet Jan. 26, 2018, retrieved from URL: <https://www.pinterest.com/pin/277675133254300672/>.*

* cited by examiner

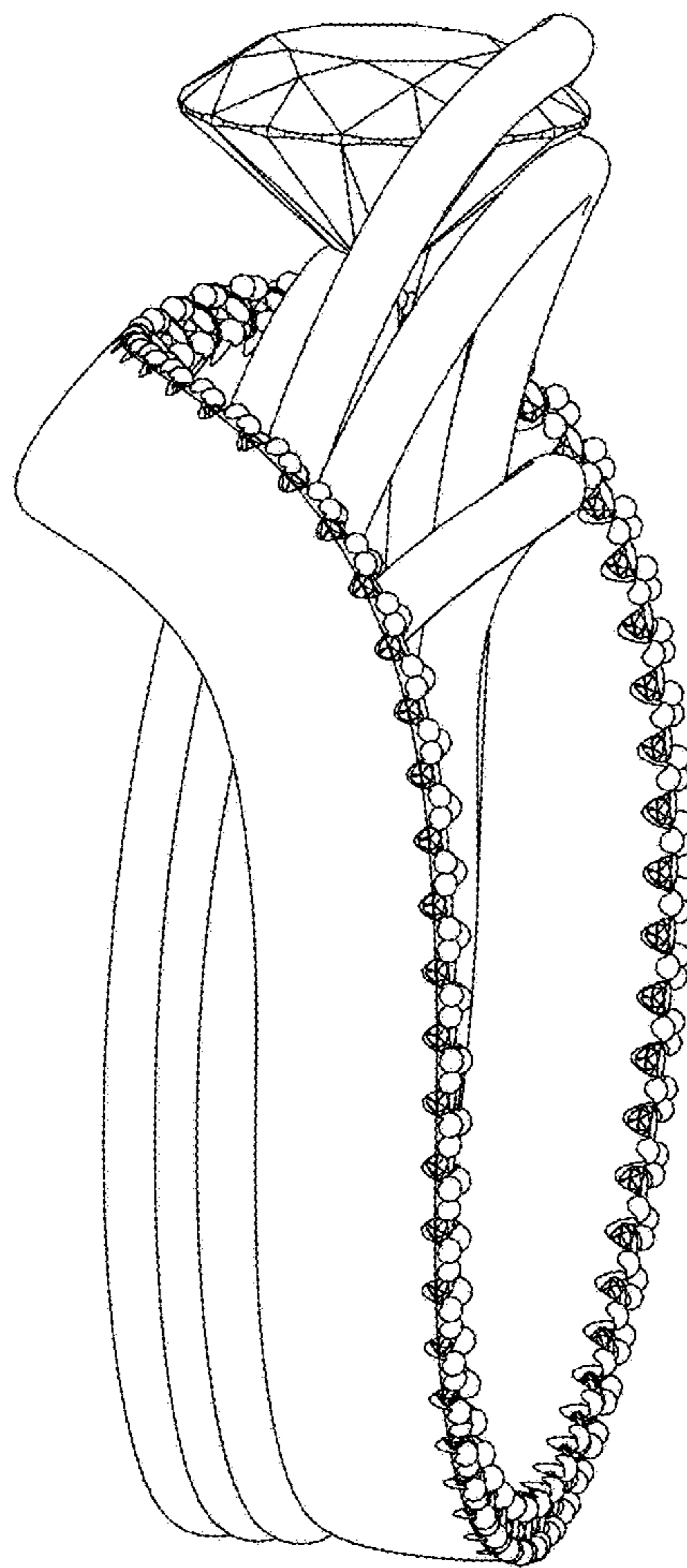

FIG. 1

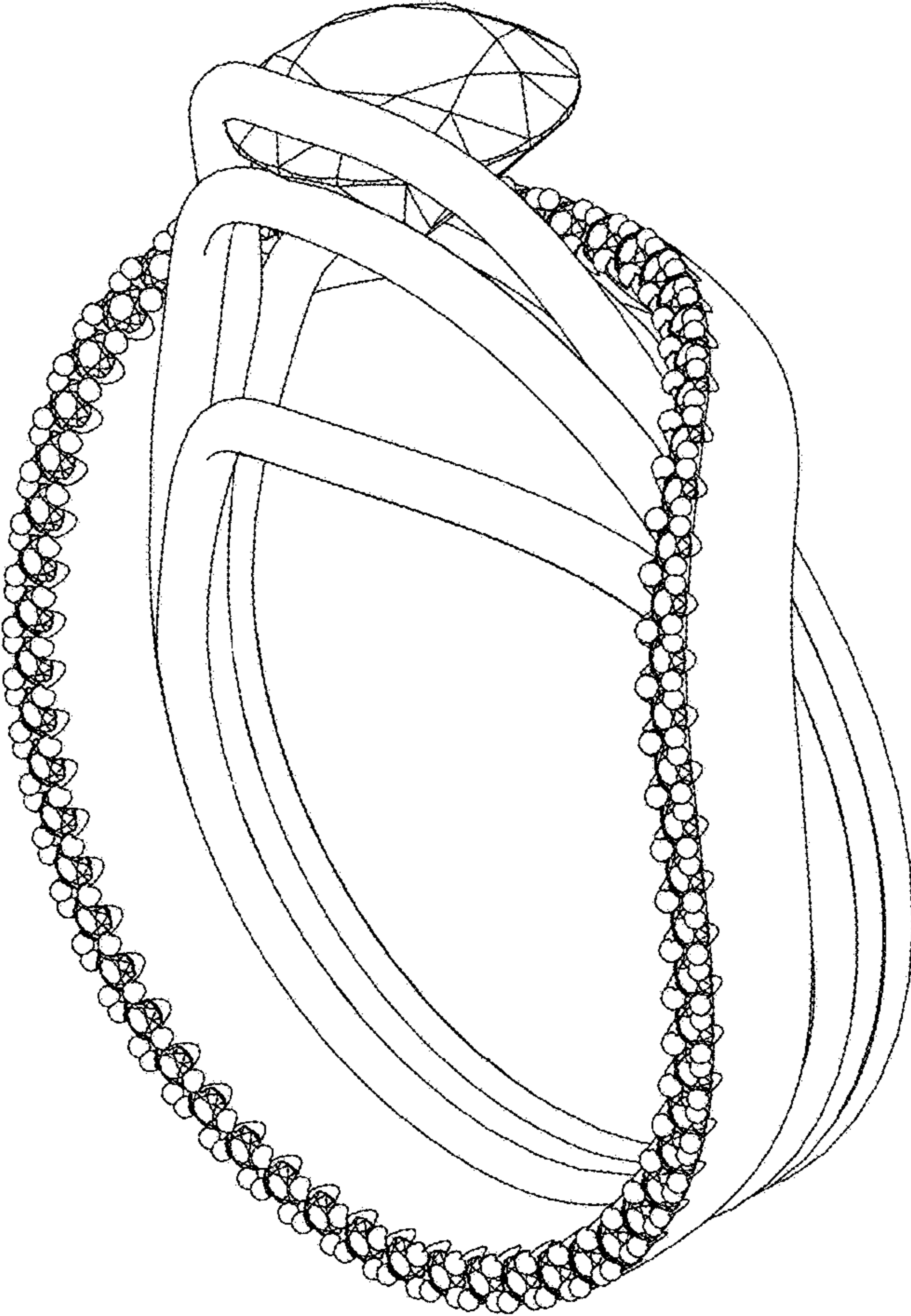

FIG. 2

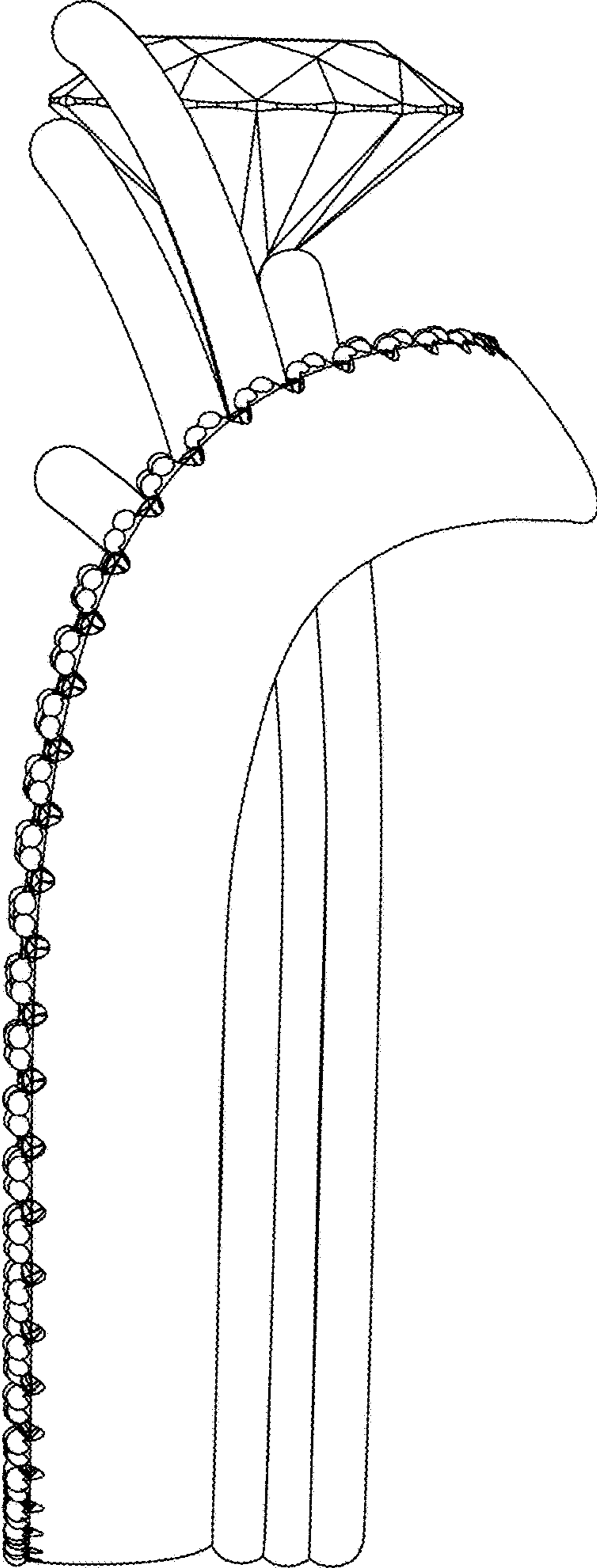

FIG. 3

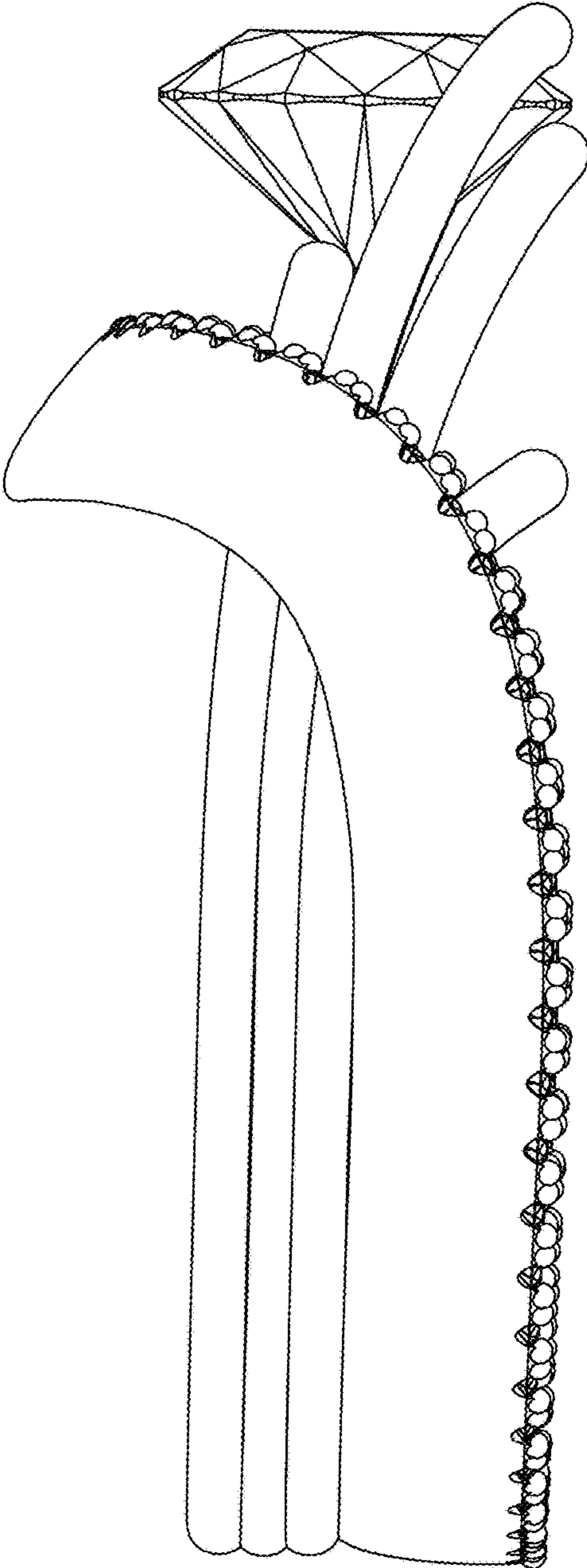

FIG. 4

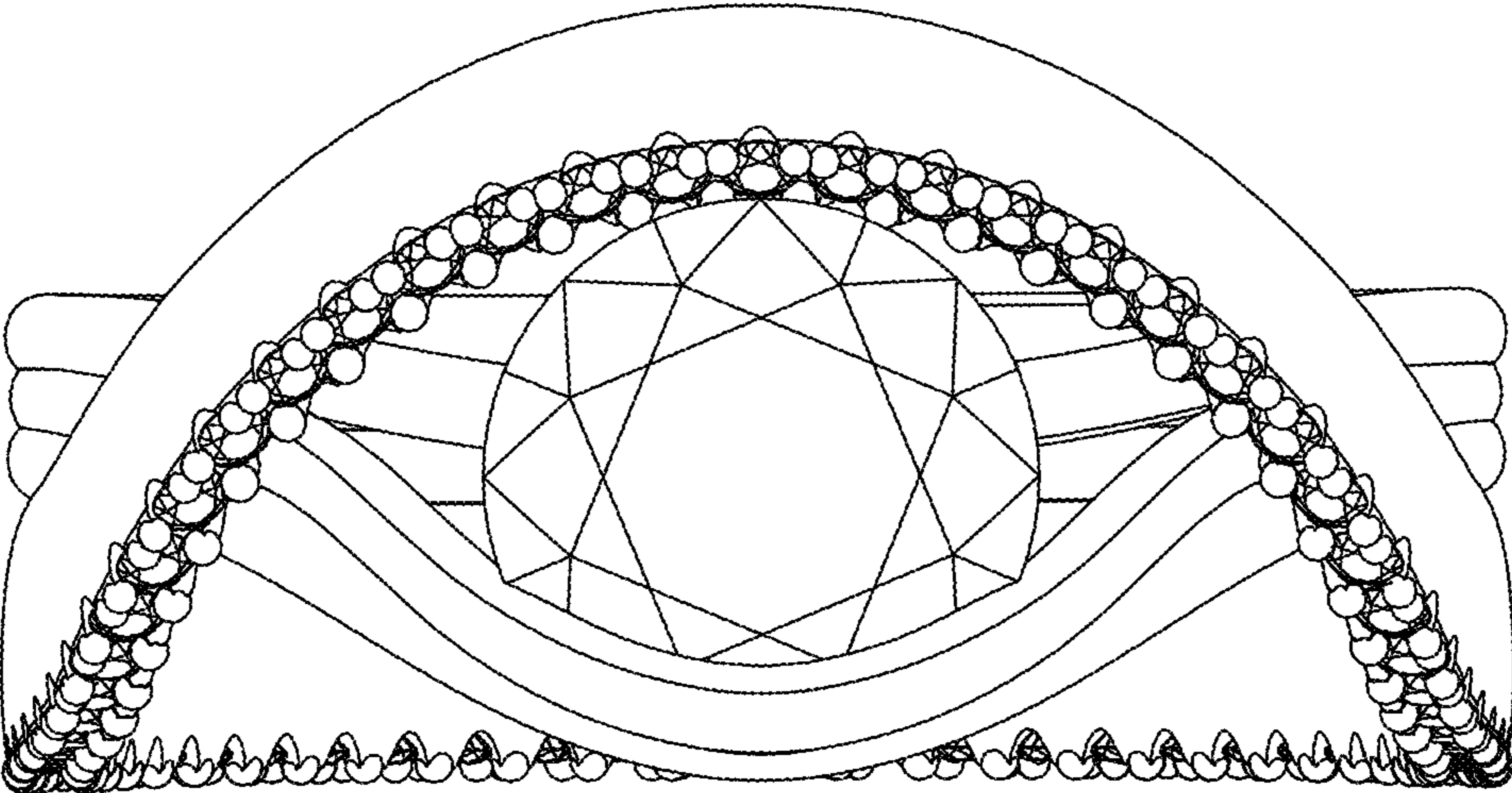

FIG. 5

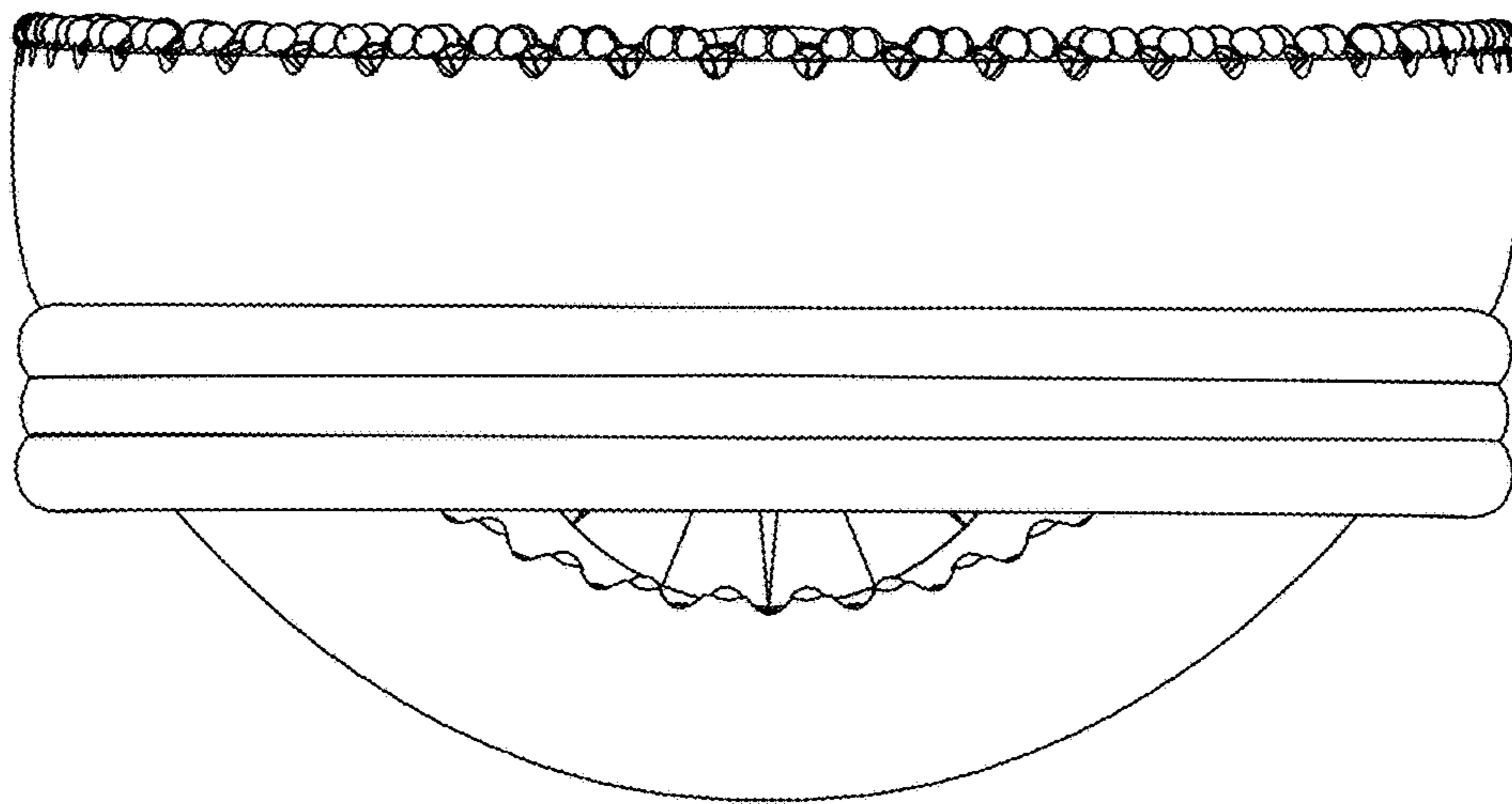

FIG. 6

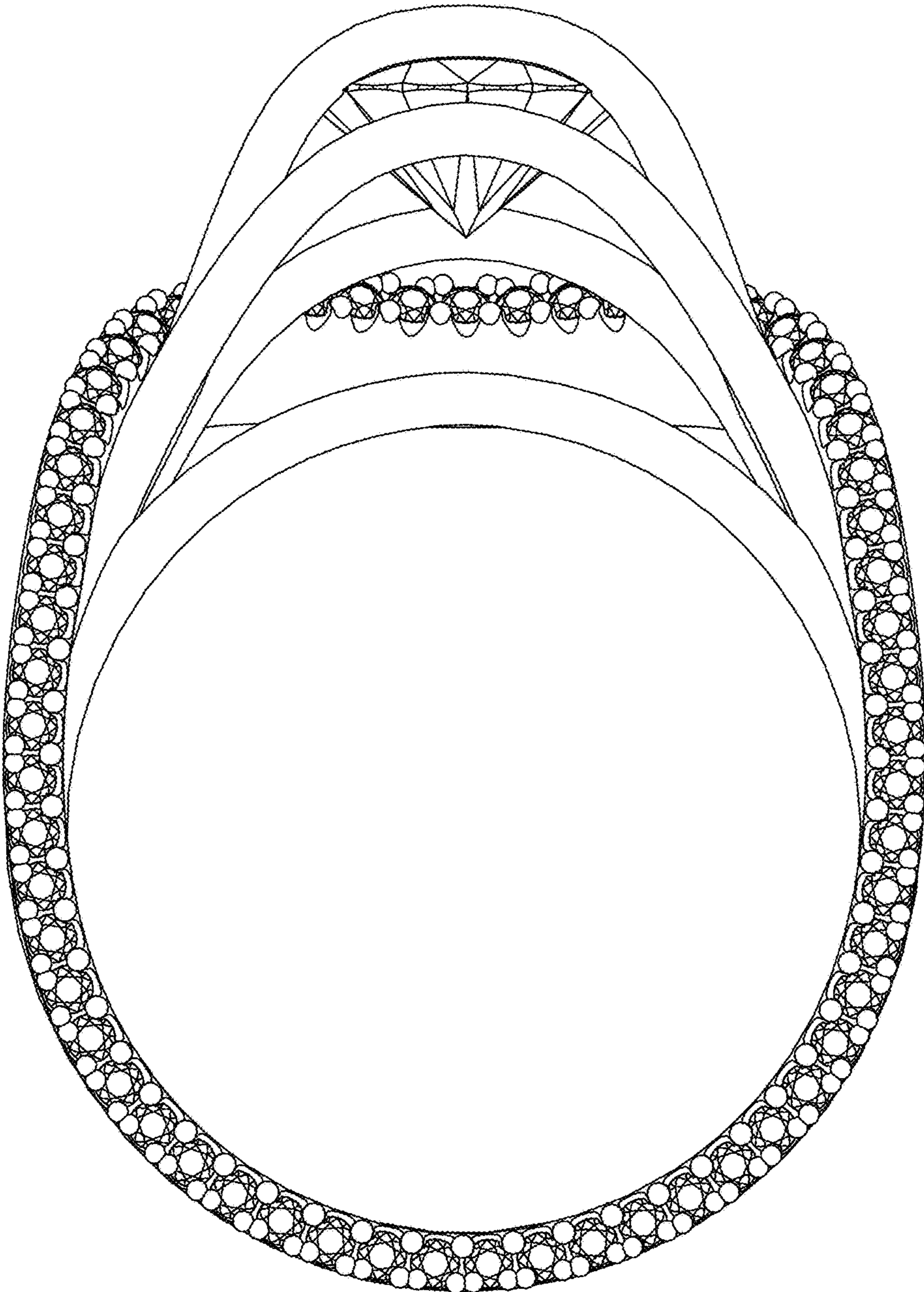

FIG. 7

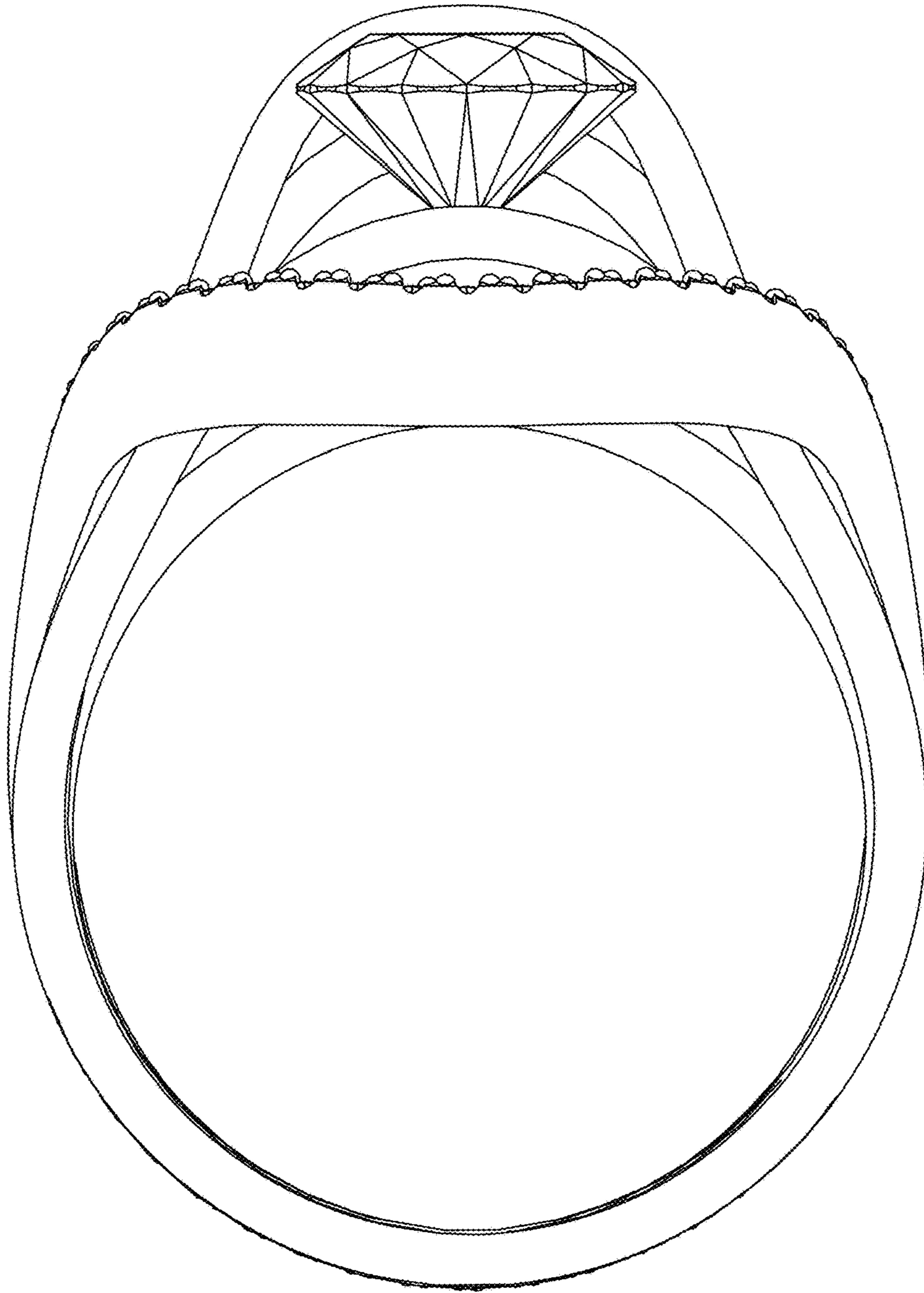

FIG. 8

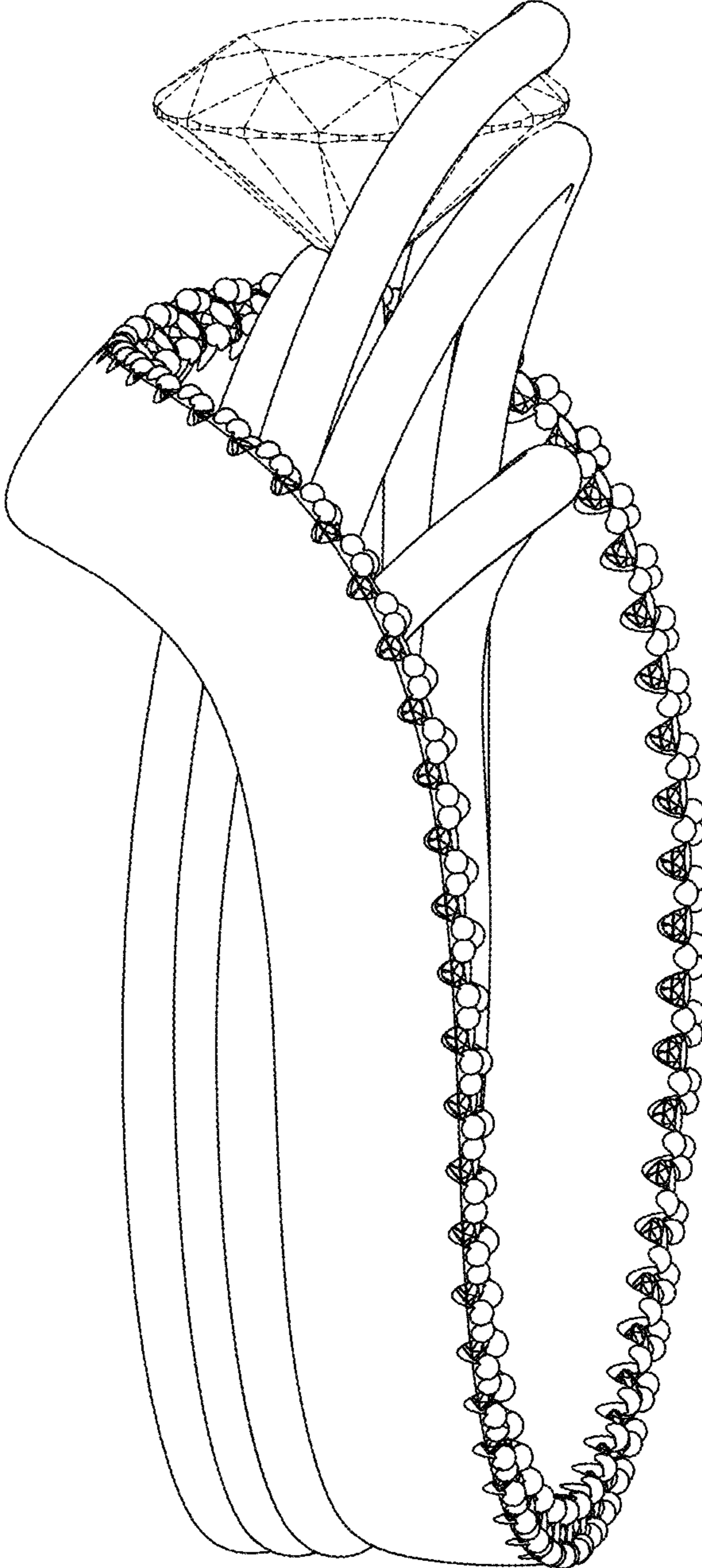

FIG. 9

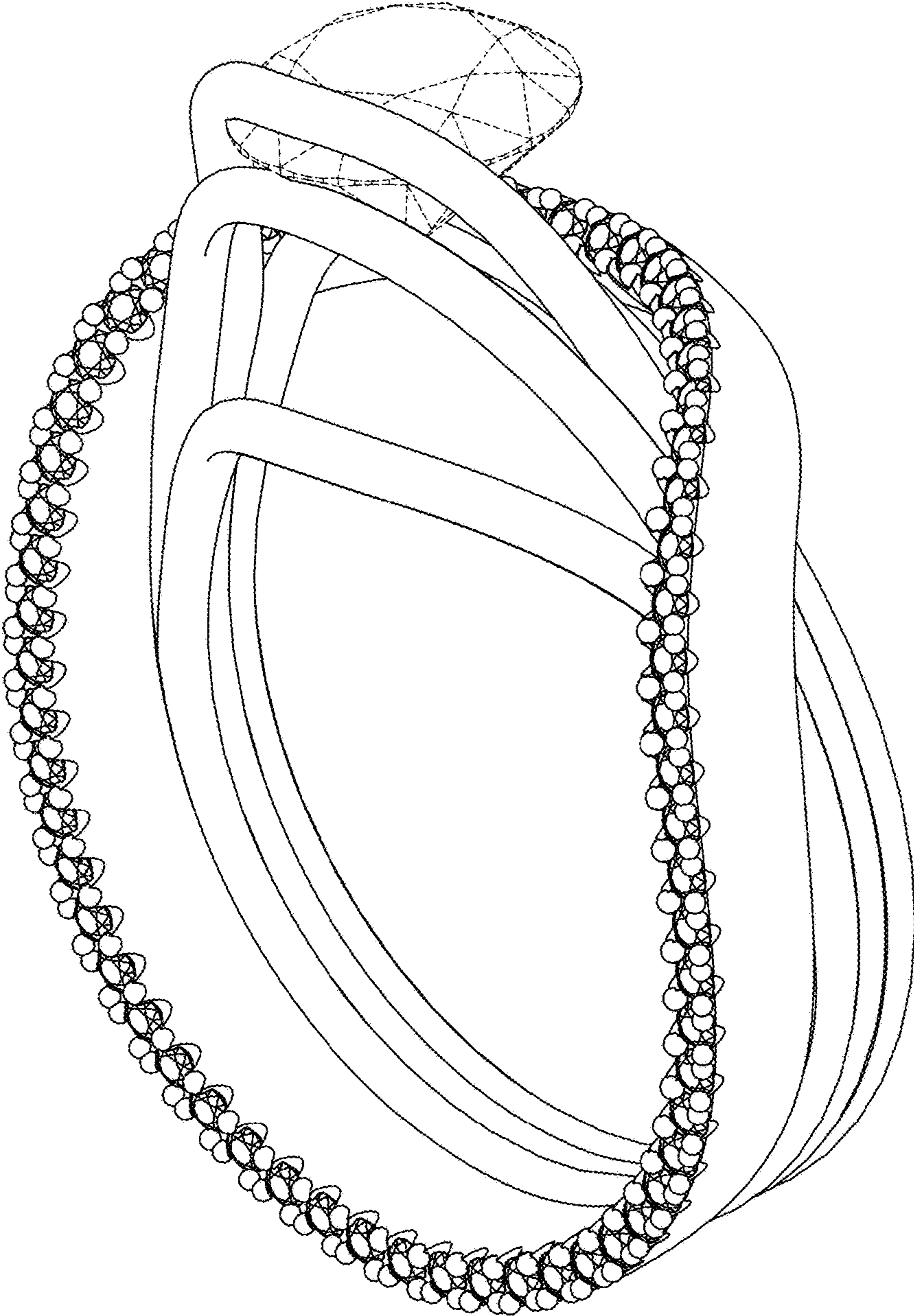

FIG. 10

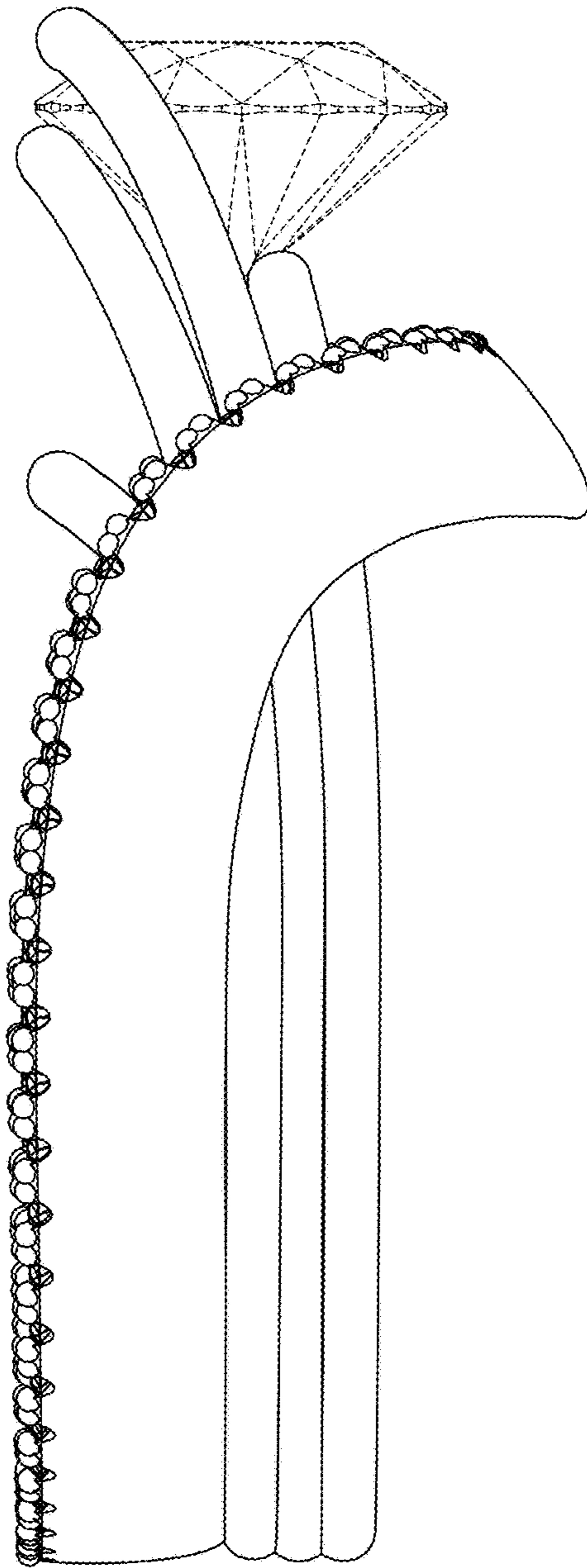

FIG. 11

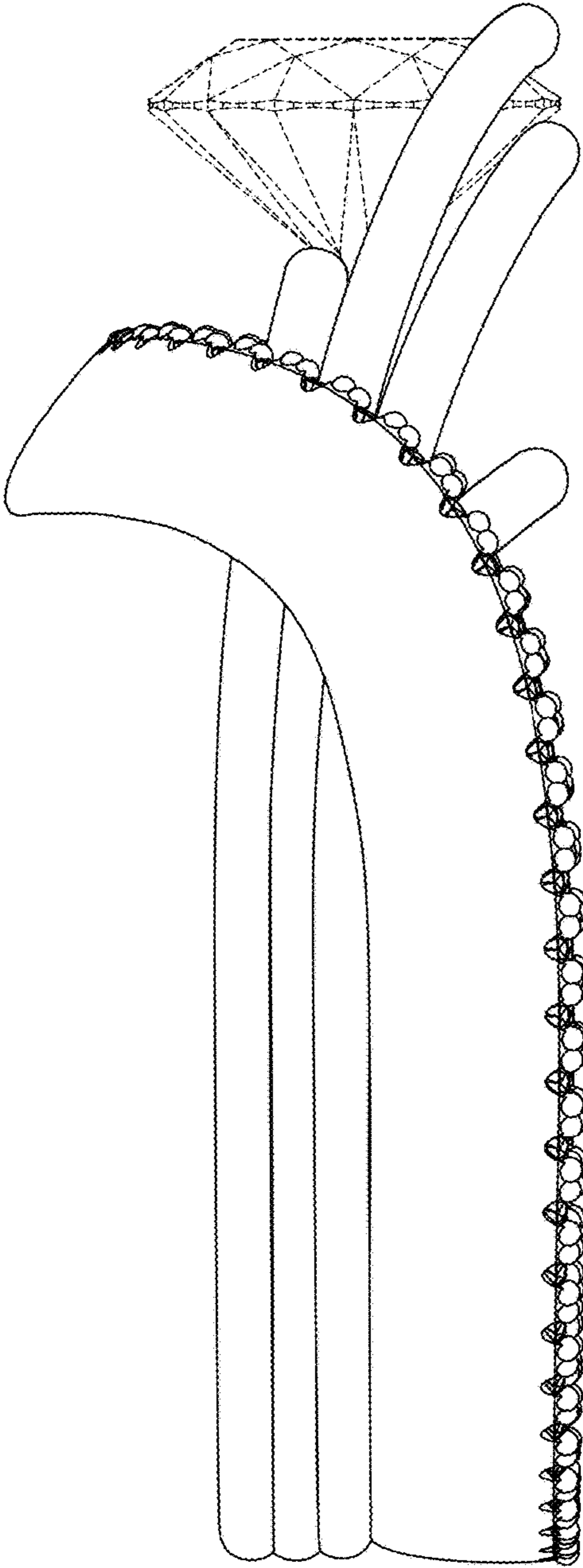

FIG. 12

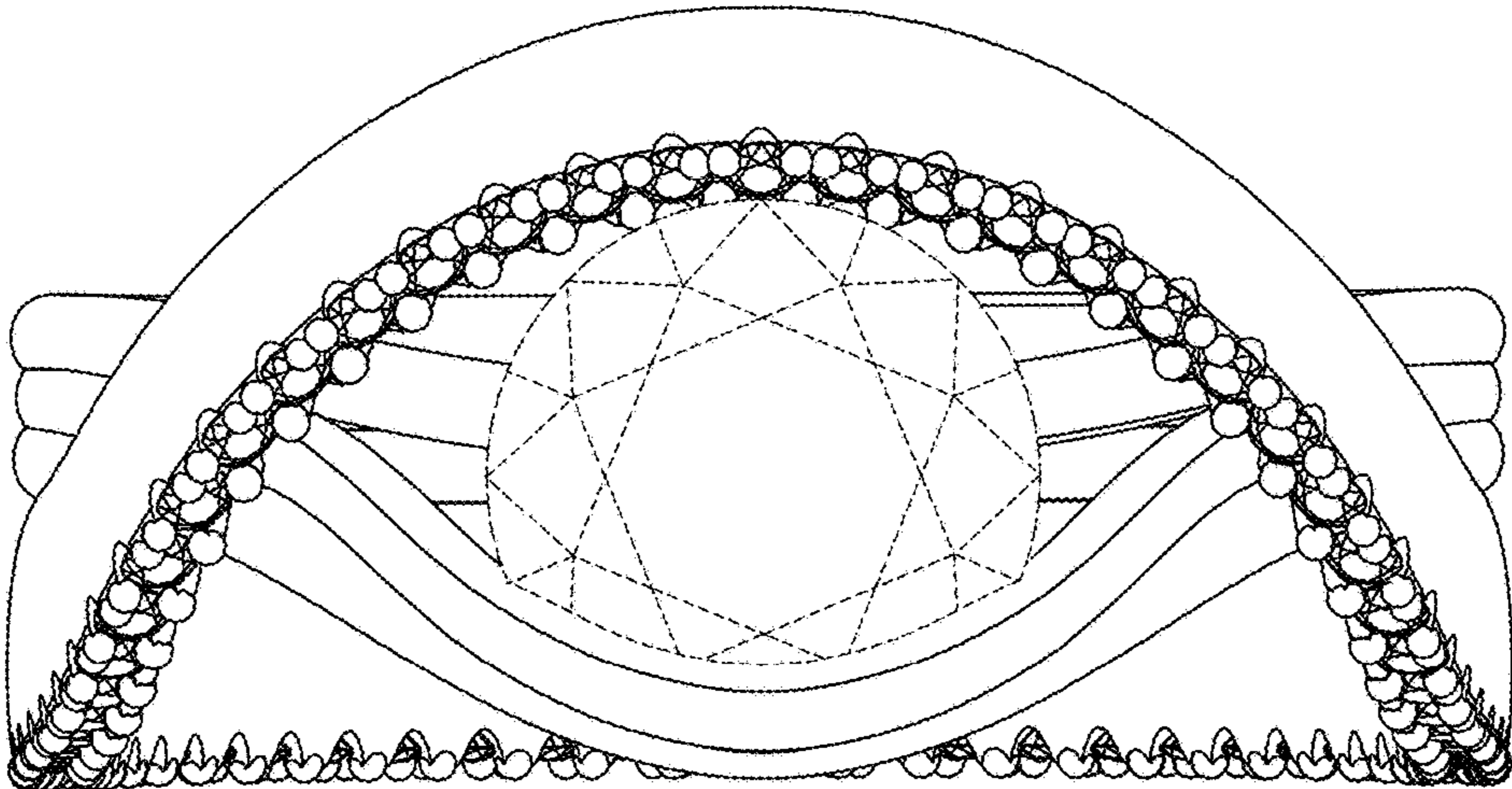

FIG. 13

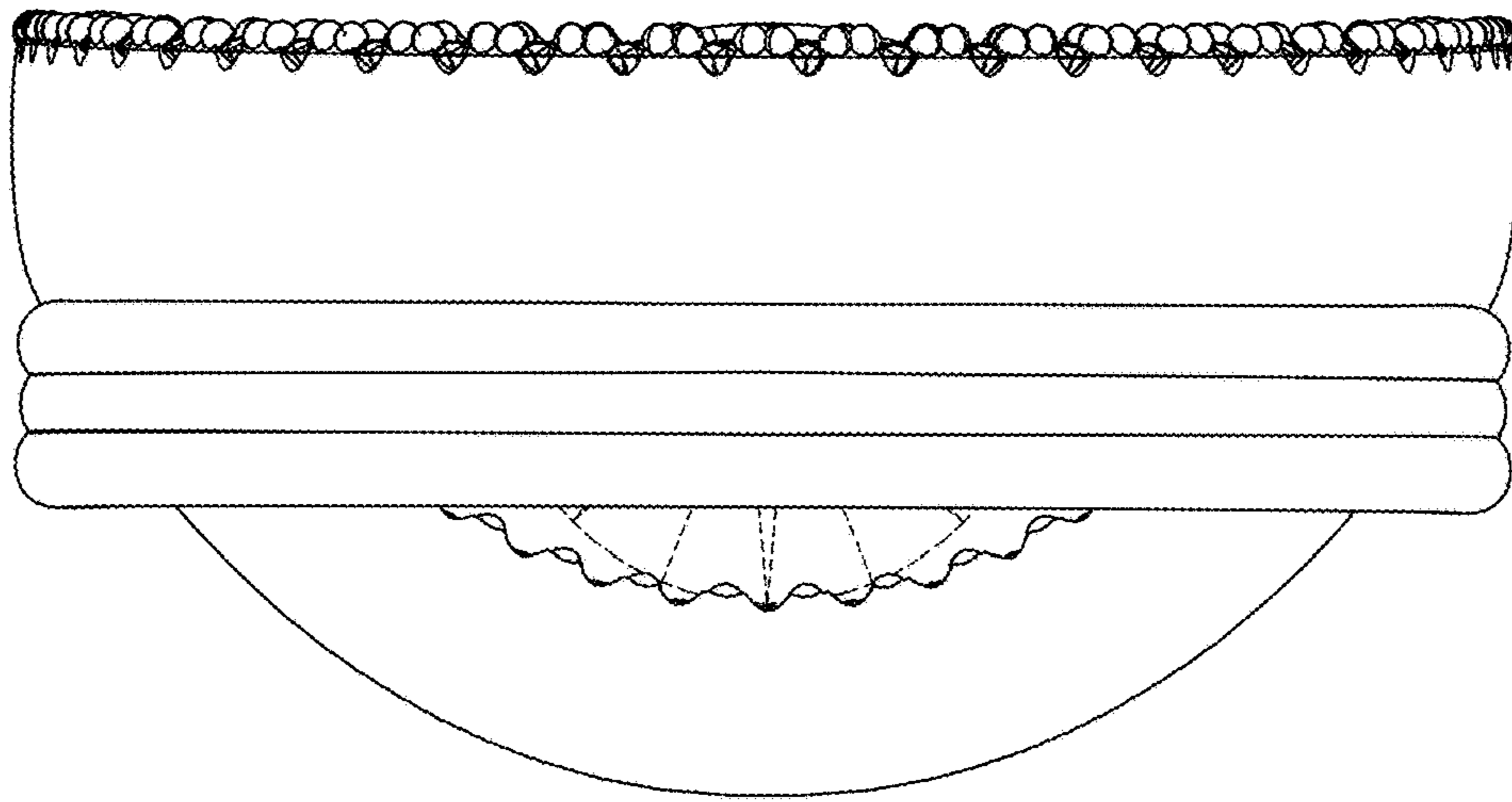

FIG. 14

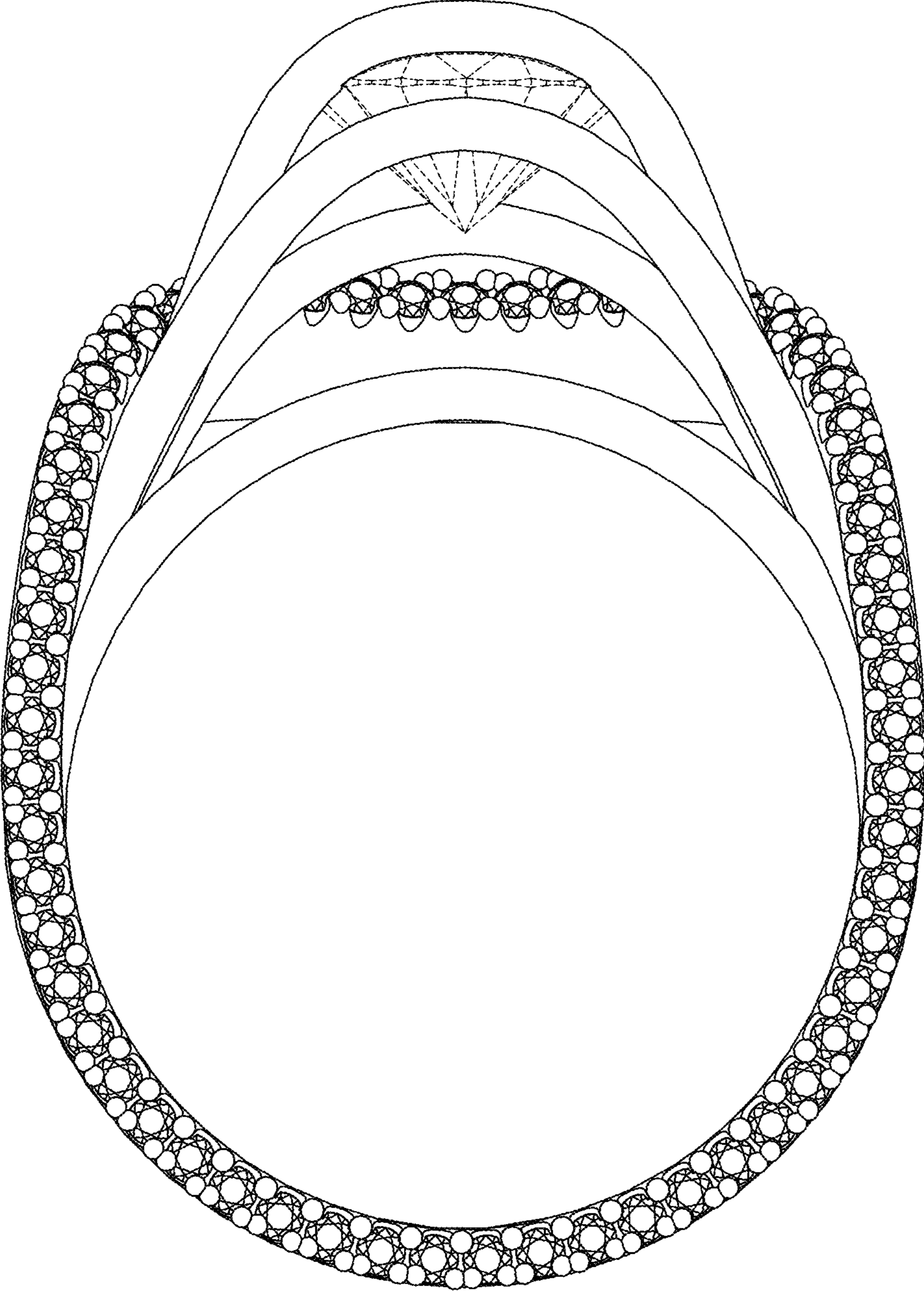

FIG. 15

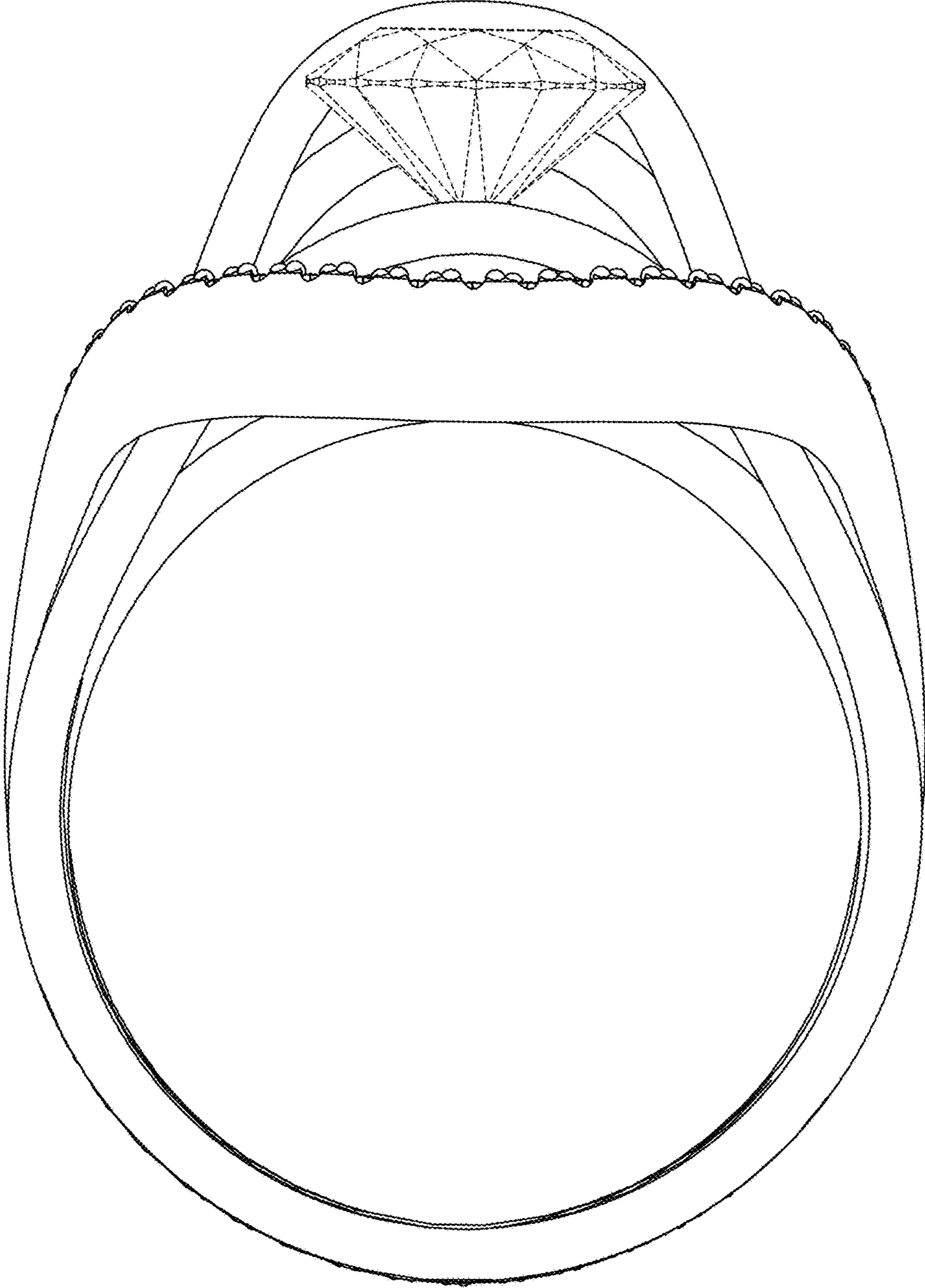

FIG. 16