



US00D840825S

(12) **United States Design Patent** (10) **Patent No.:** **US D840,825 S**
Miller et al. (45) **Date of Patent:** **** Feb. 19, 2019**

(54) **CONTAINER**

Assistant Examiner — Fritzgerald L Butac

(71) Applicant: **The Procter & Gamble Company**,
Cincinnati, OH (US)

(74) *Attorney, Agent, or Firm* — Alexandra S. Anoff

(72) Inventors: **Douglas Scott Miller**, Lebanon, OH
(US); **Peter Karl Patzak**, Darmstadt
(DE); **Marek Mikovec**, Roudnice Nad
Labem (CZ)

(57) **CLAIM**

The ornamental design for a container, as shown and described.

(73) Assignee: **The Procter and Gamble Company**,
Cincinnati, OH (US)

DESCRIPTION

(**) Term: **15 Years**

(21) Appl. No.: **29/561,758**

(22) Filed: **Apr. 20, 2016**

(51) **LOC (11) Cl.** **09-01**

(52) **U.S. Cl.**
USPC **D9/545**; D9/529

(58) **Field of Classification Search**
USPC D6/528; D7/509, 527, 529;
D9/500–505, 516, 519, 523, 525, 529,
(Continued)

FIG. 1 is a perspective view of a first embodiment of a container, embodying our new design;
FIG. 2 is a front view thereof;
FIG. 3 is a back view thereof;
FIG. 4 is a right side view thereof;
FIG. 5 is a left side view thereof;
FIG. 6 is a top plan view thereof;
FIG. 7 is a bottom view thereof;
FIG. 8 is a perspective view of a second embodiment of a container, embodying our new design;
FIG. 9 is a front view thereof;
FIG. 10 is a back view thereof;
FIG. 11 is a right side view thereof;
FIG. 12 is a left side view thereof;
FIG. 13 is a top plan view thereof;
FIG. 14 is a bottom view thereof;
FIG. 15 is a perspective view of a third embodiment of a container, embodying our new design;
FIG. 16 is a front view thereof;
FIG. 17 is a back view thereof;
FIG. 18 is a right side view thereof;
FIG. 19 is a left side view thereof;
FIG. 20 is a top plan view thereof;
FIG. 21 is a bottom view thereof;
FIG. 22 is a perspective view of a fourth embodiment of a container, embodying our new design;
FIG. 23 is a front view thereof;
FIG. 24 is a back view thereof;
FIG. 25 is a right side view thereof;
FIG. 26 is a left side view thereof;
FIG. 27 is a top plan view thereof; and,
FIG. 28 is a bottom view thereof.

(56) **References Cited**

U.S. PATENT DOCUMENTS

D484,402 S * 12/2003 Crawford D9/693
D535,567 S * 1/2007 Snyder D9/551
(Continued)

OTHER PUBLICATIONS

Head and Shoulders Dry Scalp Care, Almond Oil, Dandruff Shampoo, posted on amazon.com, earliest review posted Dec. 13, 2011, no production date given, [online], [site visited May 17, 2017], Available from Internet, <URL: https://www.amazon.com/Head-Shoulders-Almond-Dandruff-Shampoo/product-reviews/B000GCXSHO/ref=cm_cr_getr_d_paging_btm_24?ie=UTF8>.
(Continued)

Primary Examiner — Garth Rademaker

(Continued)

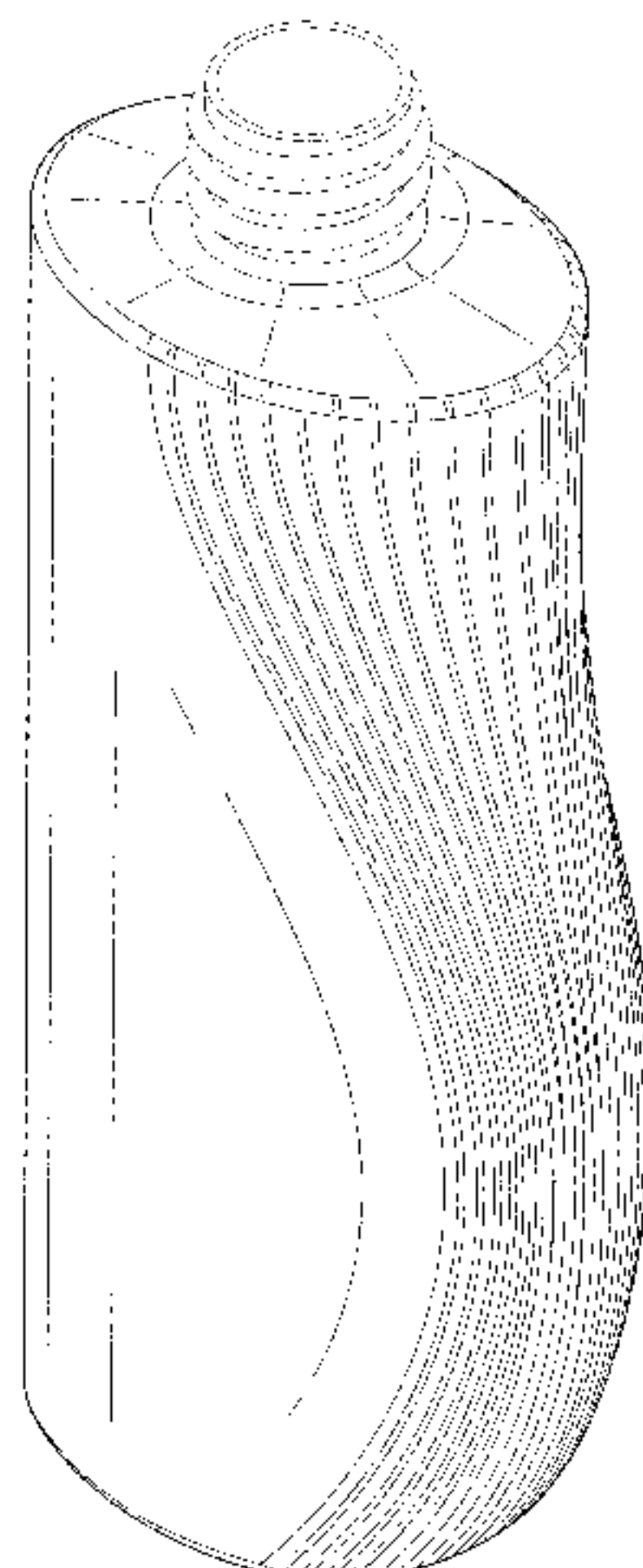

The broken lines show portions of a container that form no part of the claimed design.

1 Claim, 20 Drawing Sheets

(58) **Field of Classification Search**

USPC D9/539, 544–546, 549, 550, 554–556,
D9/558, 559, 563, 565, 568, 569,
D9/572–575, 772, 776, 778, 779;
D11/143, 146, 152, 154, 156
CPC B65D 1/02
See application file for complete search history.

(56) **References Cited**

U.S. PATENT DOCUMENTS

D542,145 S *	5/2007	Campbell	D9/565
D547,655 S *	7/2007	van der Heijden	D9/434
D563,233 S *	3/2008	Patzak	D9/549
D565,424 S *	4/2008	Moriya	D9/682
D573,884 S *	7/2008	Crabtree	D9/522
D601,035 S *	9/2009	Rangaswamy	D9/694
D607,734 S *	1/2010	Kuzma	D9/539
D613,176 S *	4/2010	Gameros	D9/558
D614,494 S *	4/2010	Palmer	D9/516
D626,843 S *	11/2010	Oates	D9/516
D626,858 S *	11/2010	Oates	D9/682
D642,061 S *	7/2011	Bowers	D9/522
D643,737 S *	8/2011	Handy	D9/558
D656,839 S *	4/2012	Shaw	D9/682
D669,359 S *	10/2012	Kuzma	D9/542
D692,302 S *	10/2013	Oates	D9/516
D713,728 S *	9/2014	Brewer	D9/541
D715,149 S *	10/2014	Brewer	D9/529
D717,178 S *	11/2014	Brewer	D9/448
D719,453 S *	12/2014	Bunce	D9/542
D746,146 S *	12/2015	Wilkum	D9/535
D747,972 S *	1/2016	Allan	D9/682

D748,490 S *	2/2016	Allan	D9/563
D748,491 S *	2/2016	Jin	D9/682
D752,991 S *	4/2016	Ober	D9/691
D763,089 S *	8/2016	Handy	D9/530
D766,097 S *	9/2016	Lee	D9/690
D776,541 S *	1/2017	Jin	D9/520
D780,594 S *	3/2017	Harris	D9/682
D784,139 S *	4/2017	Robinson, II	D9/516
D784,822 S *	4/2017	Yen	D9/574

OTHER PUBLICATIONS

Herbal Essences Classic Moisturising Conditioner, posted on bigw.com.au, no posted date given, no production date given, [online], [site visited May 17, 2017], Available from Internet, <URL: <https://www.bigw.com.au/product/herbal-essences-classic-moisturising-conditioner-490-ml/p/WCC100000000289151/?siteName=B1G+W#>>.*

Head & Shoulders Lemon Fresh Shampoo, posted on mintmydeal.com, no posted date given, no production date given, [online], [site visited May 17, 2017], Available from Internet, <URL: http://www.mintmydeal.com/?module=product&mode=productdetails&page=withoutleft&product_id=1197>.*

Nair Shower Power Max, posted on chemistwarehouse.com.au, no posted date given, no production date given, [online], [site visited Oct. 19, 2017], Available from Internet, URL: <http://www.chemistwarehouse.com.au/buy/61185/Nair-Shower-Power-Max-312g> (Year: 2017).*

Head & Shoulders Classic Clean Anit-Dandruff 2-in-1 Shampoo, posted on amazon.co.uk, first available Dec. 8, 2014, no production date given, [online], [site visited Oct. 19, 2017], Available from Internet, URL: <https://www.amazon.co.uk/Head-Shoulders-Classic-Anti-Dandruff-Shampoo/dp/B00QPROY9U> (Year: 2017).*

Vital Care Mega Hold All Day Gel, posted on walmart.com, earliest review posted Feb. 12, 2013, no production date given, [online], [site visited Oct. 19, 2017], Available from Internet, URL: <https://www.walmart.com/ip/Vital-Care-Mega-Hold-All-Day-Gel-40-Oz/10320753#read-more> (Year: 2017).*

* cited by examiner

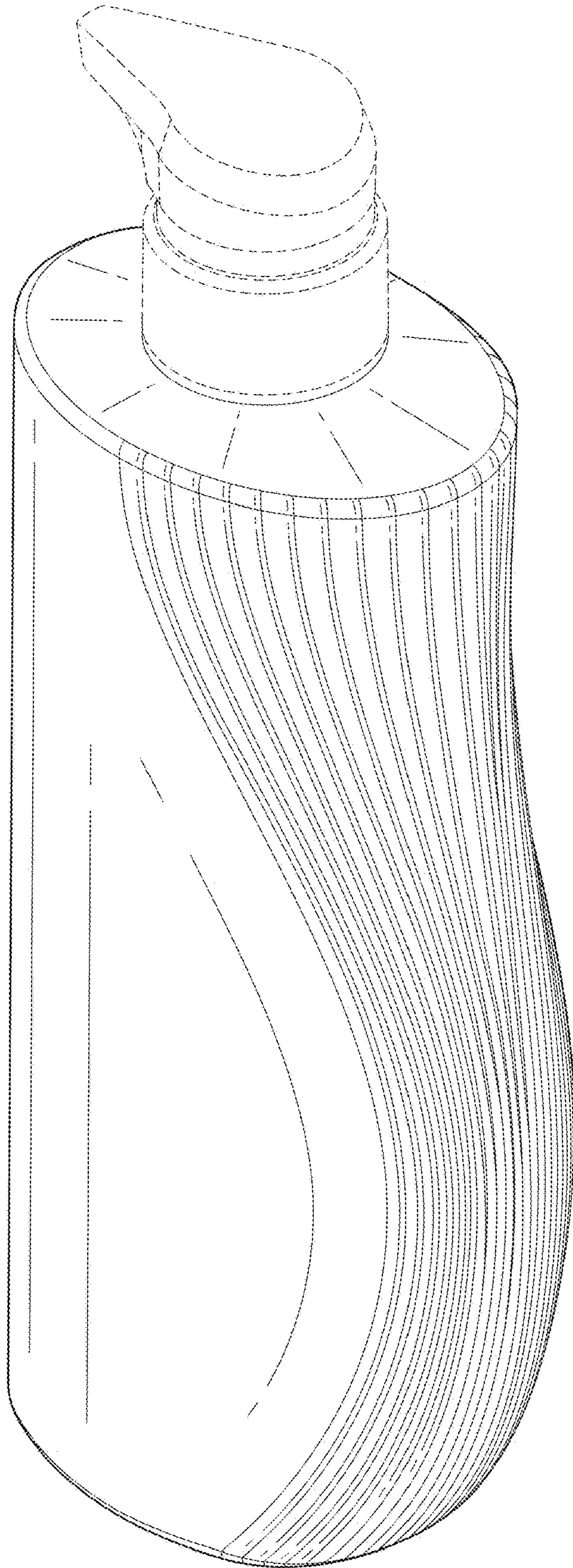

Fig. 1

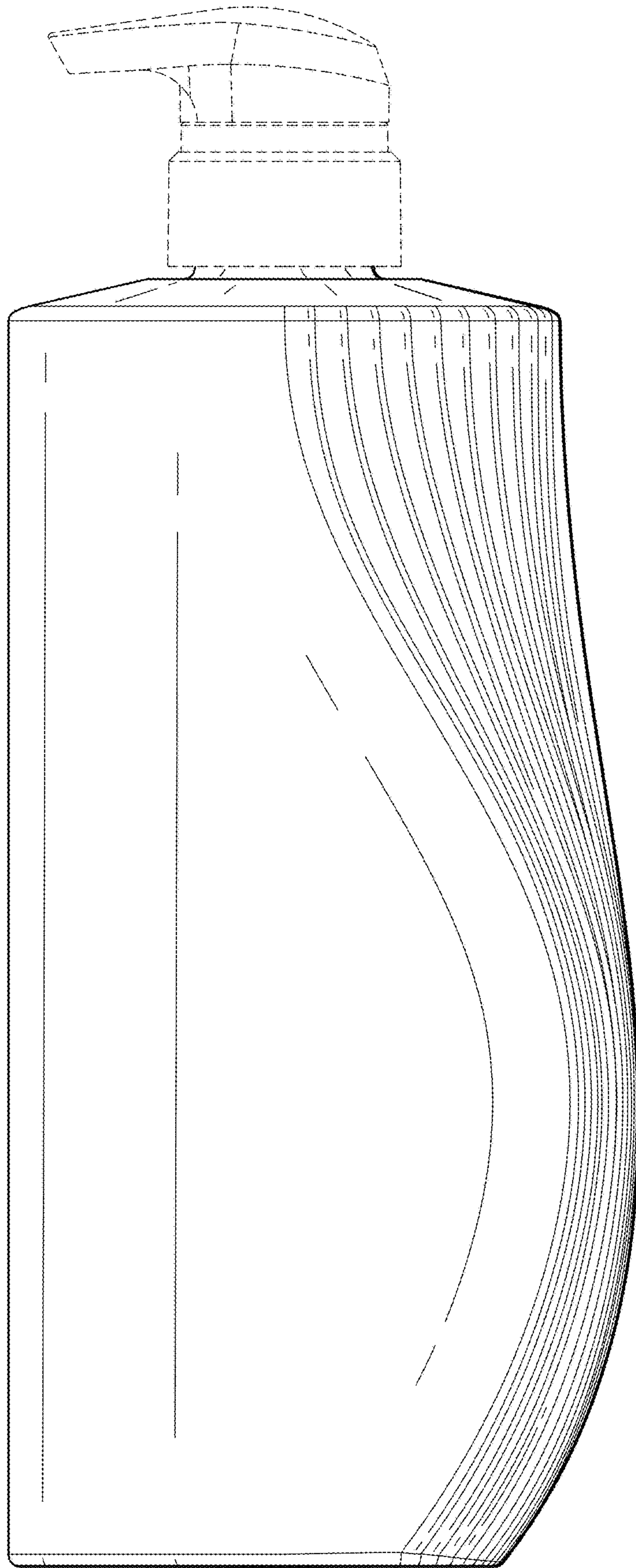

Fig. 2

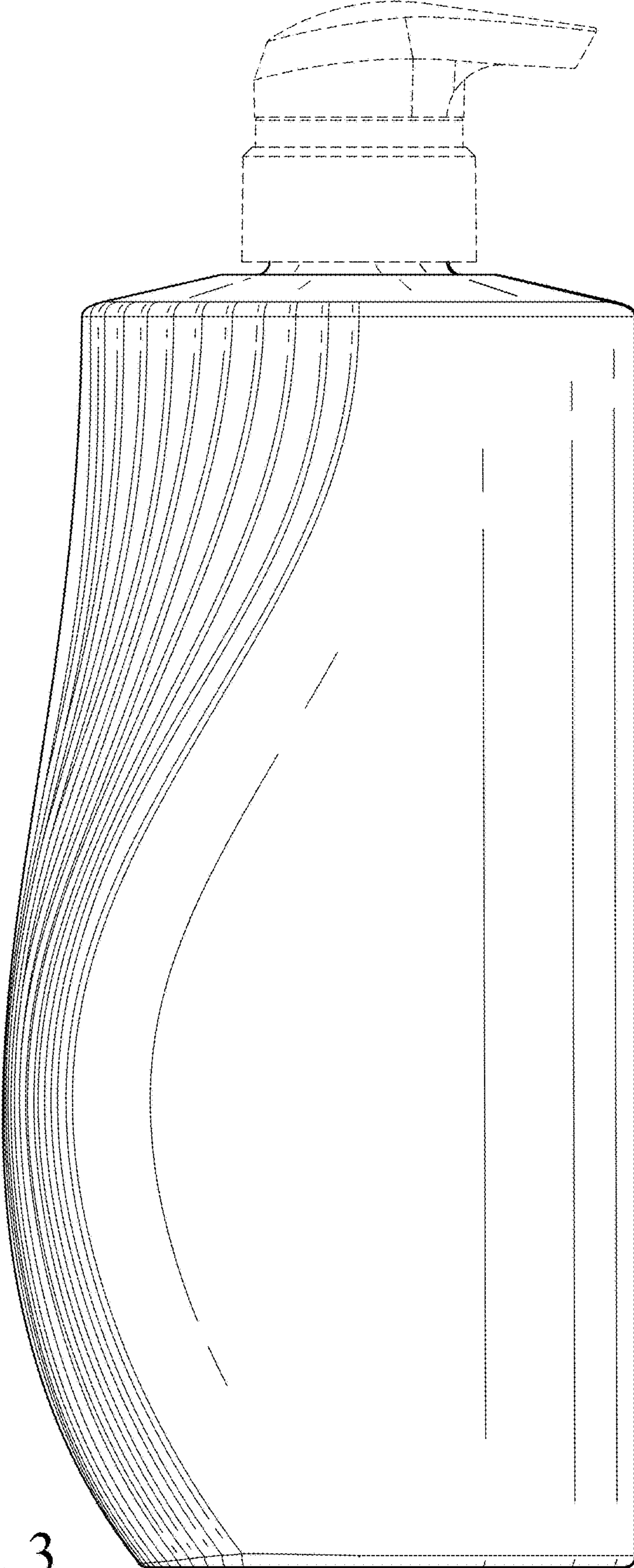

Fig. 3

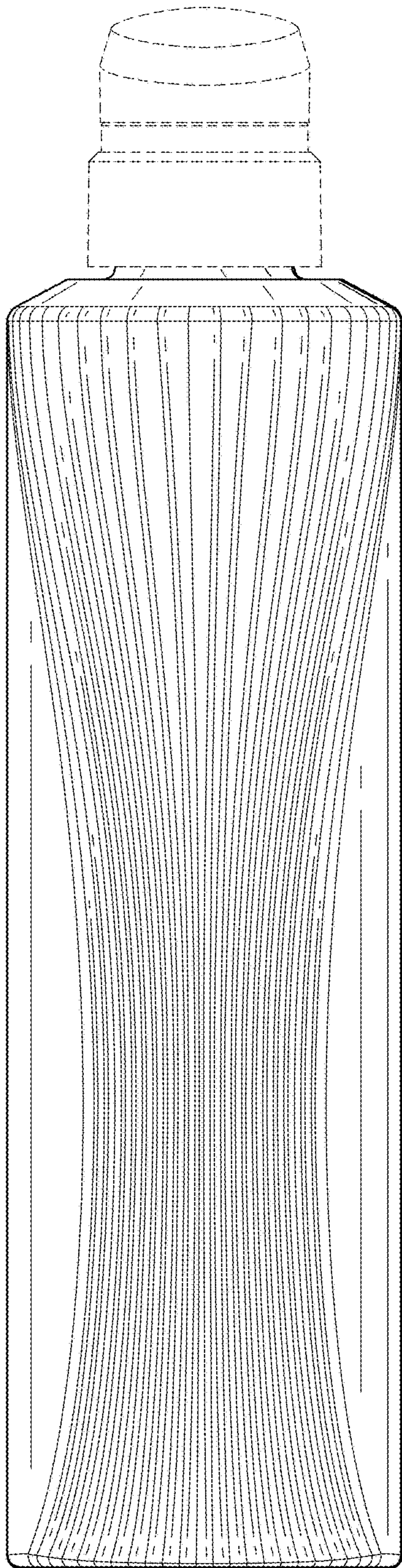

Fig. 4

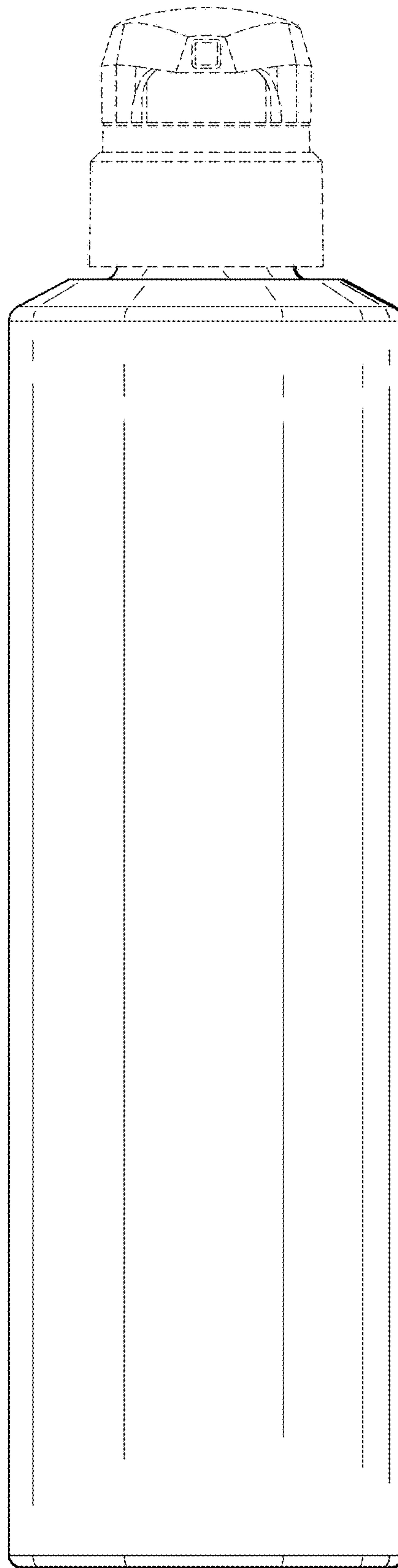

Fig. 5

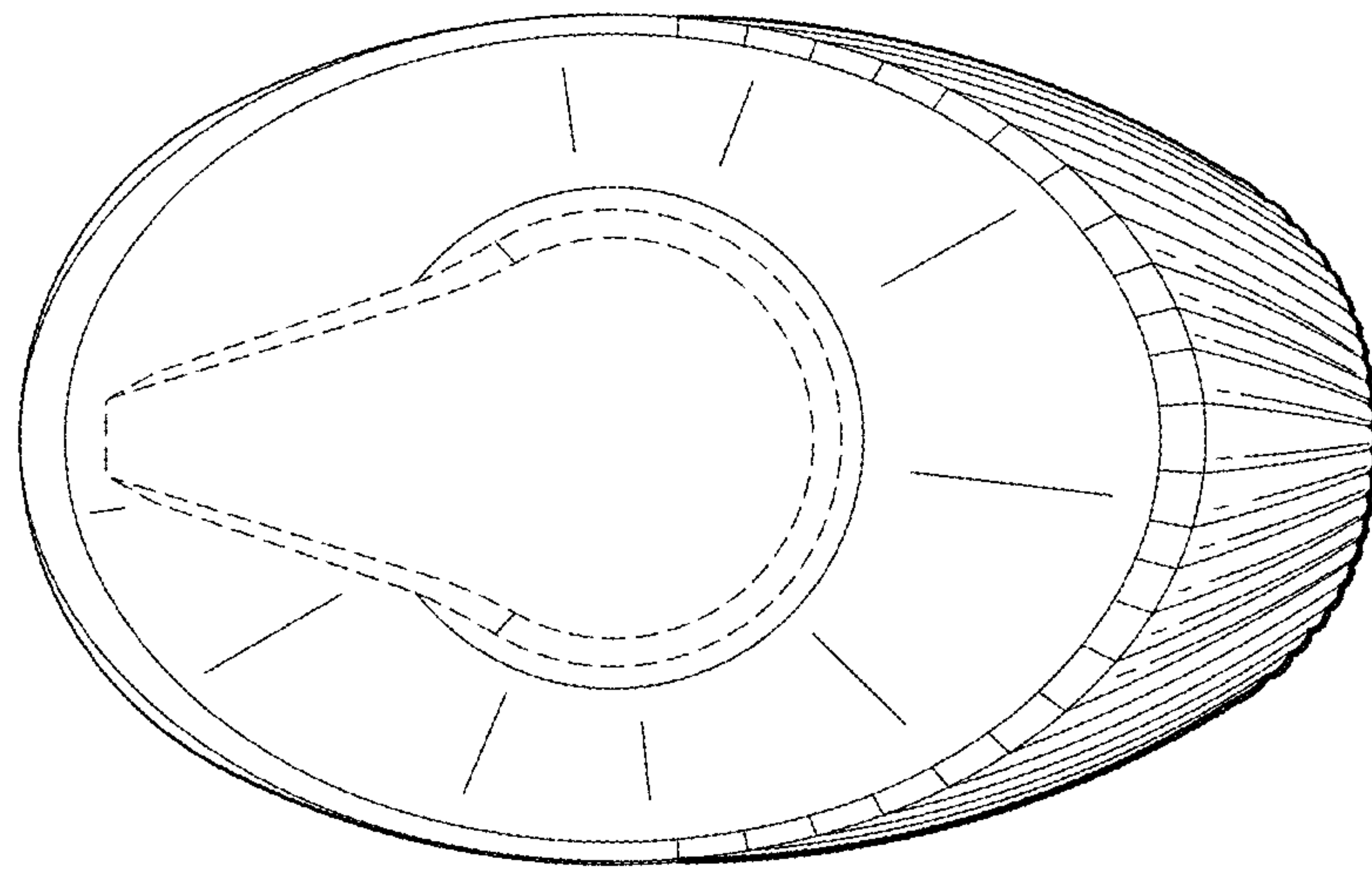

Fig. 6

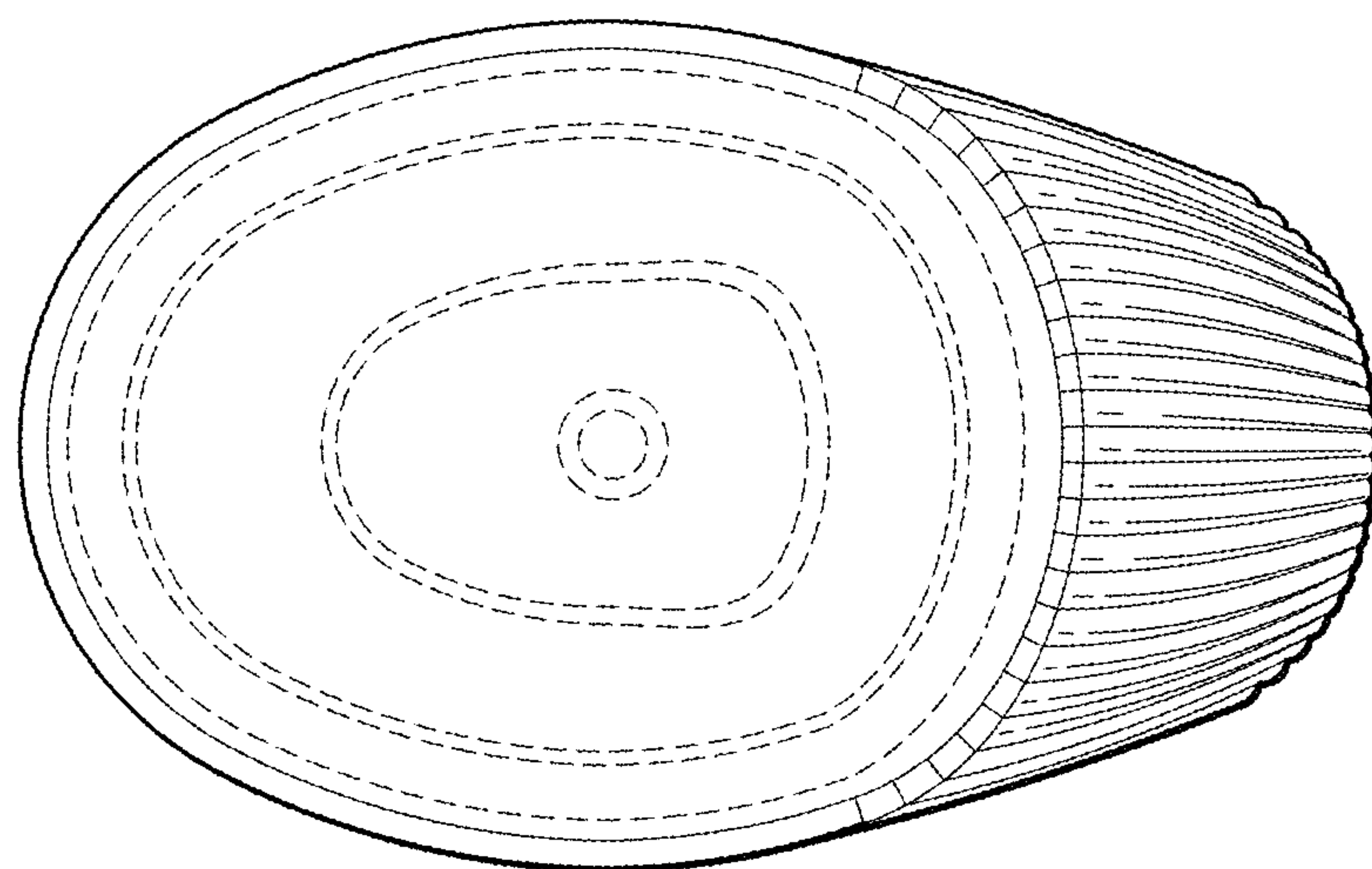

Fig. 7

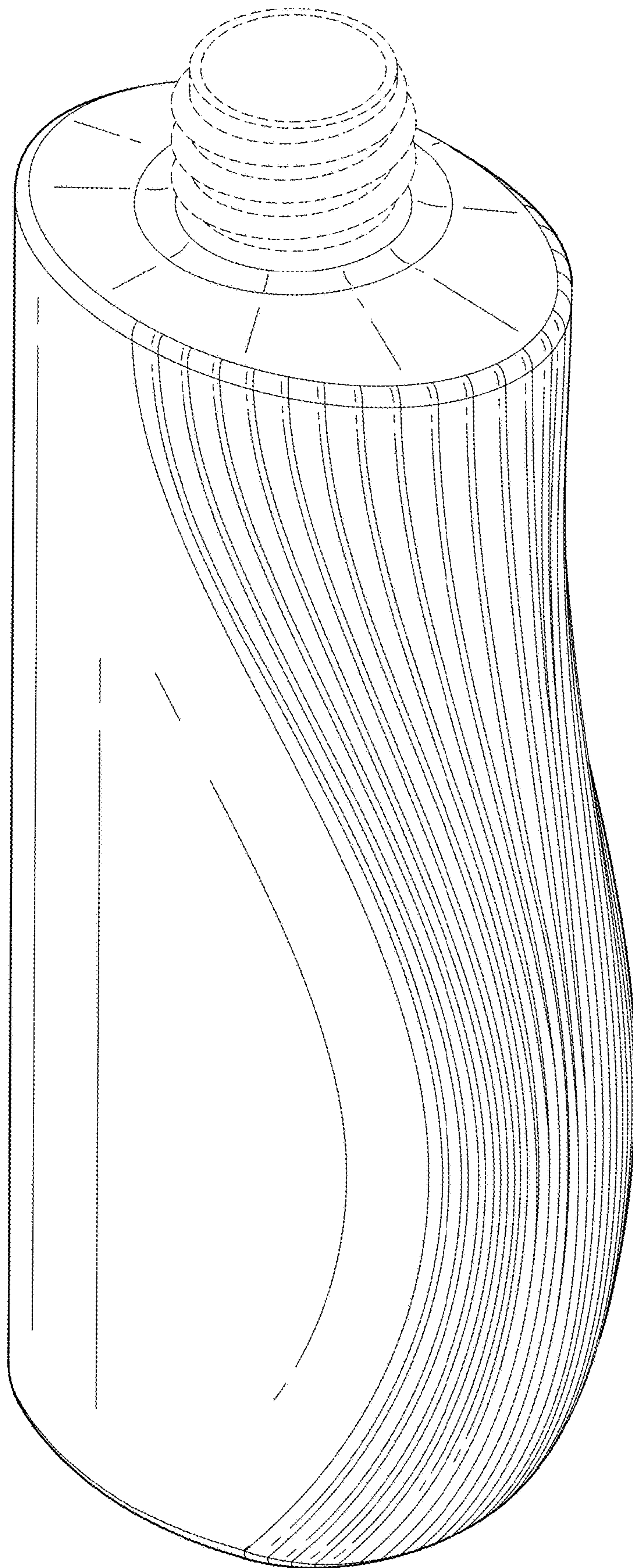

Fig. 8

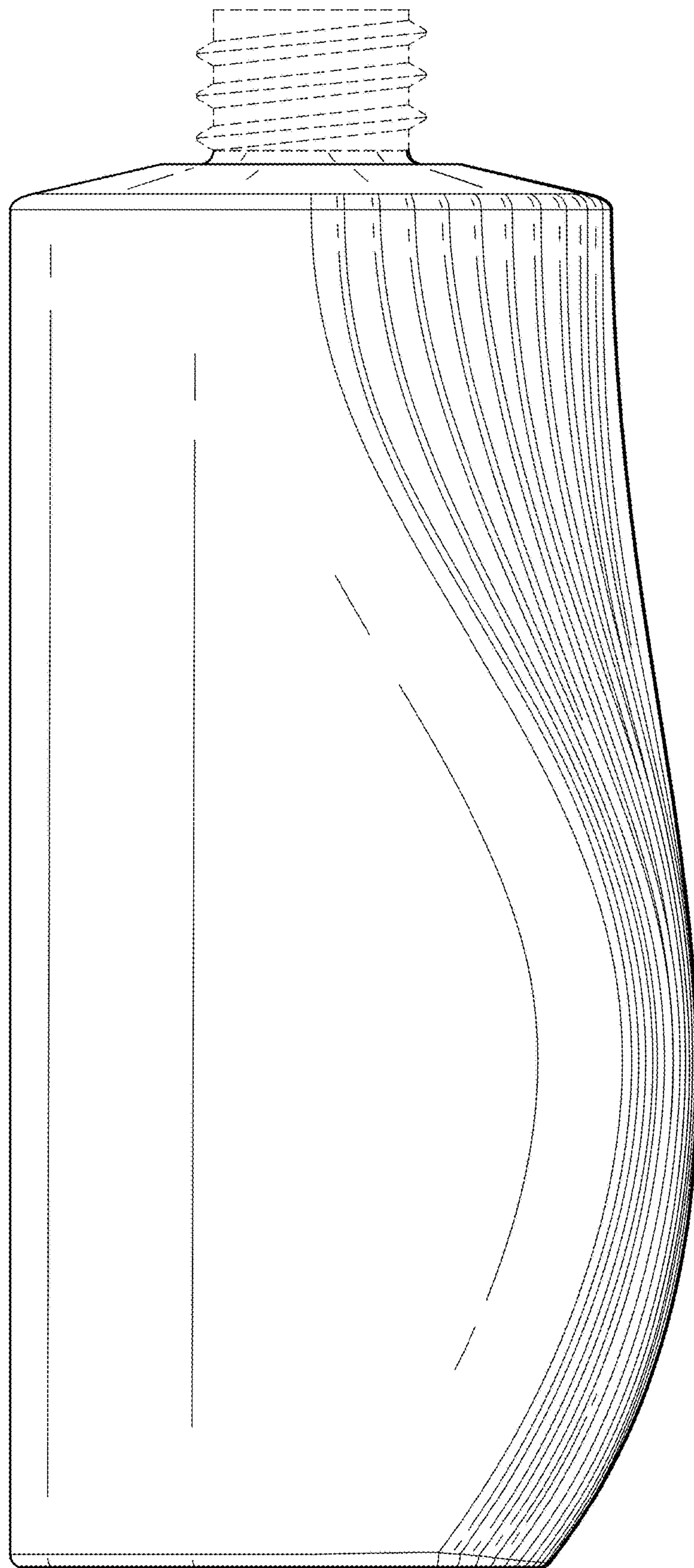

Fig. 9

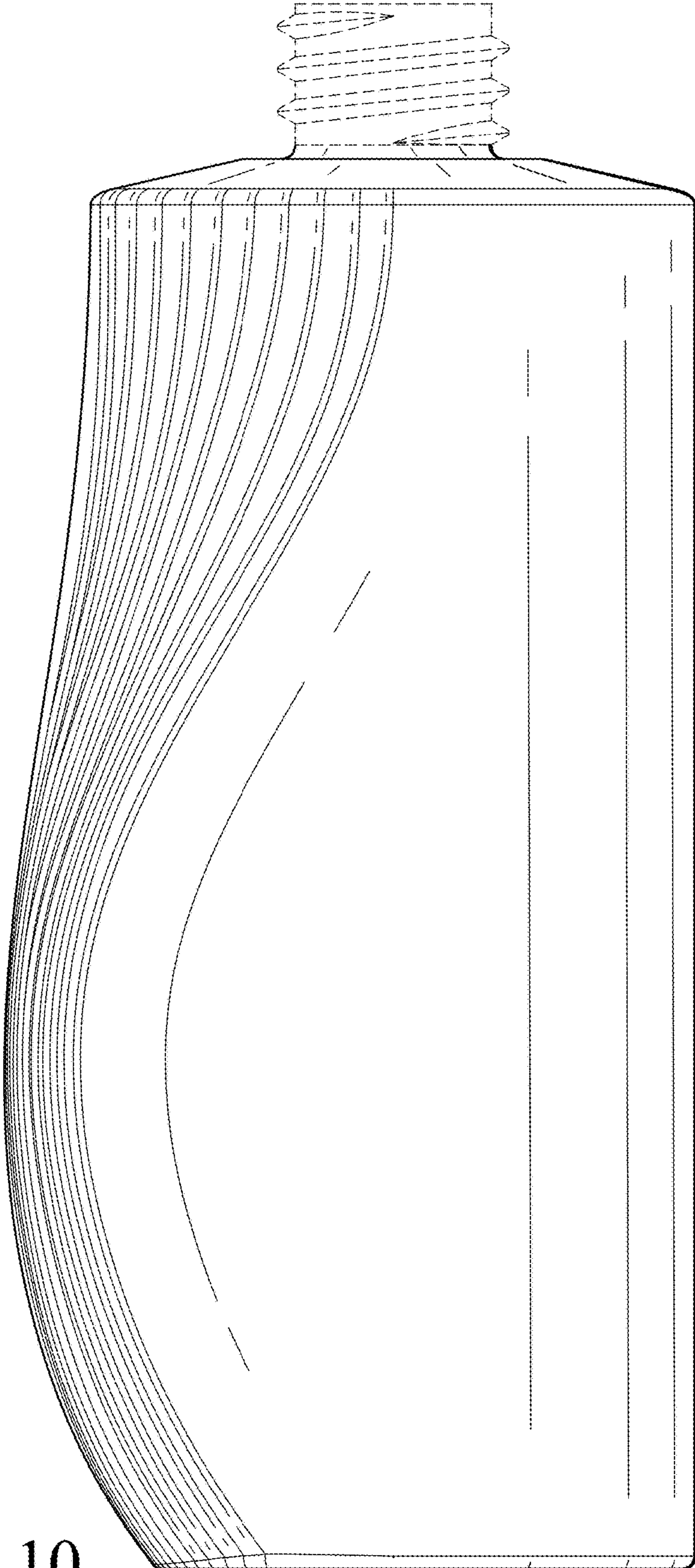

Fig. 10

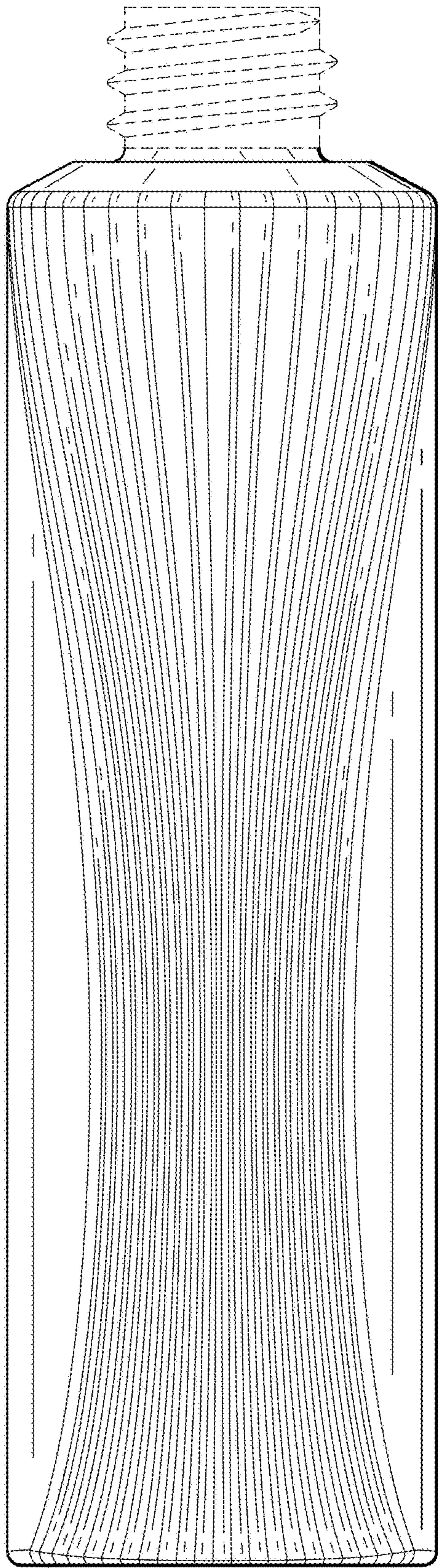

Fig. 11

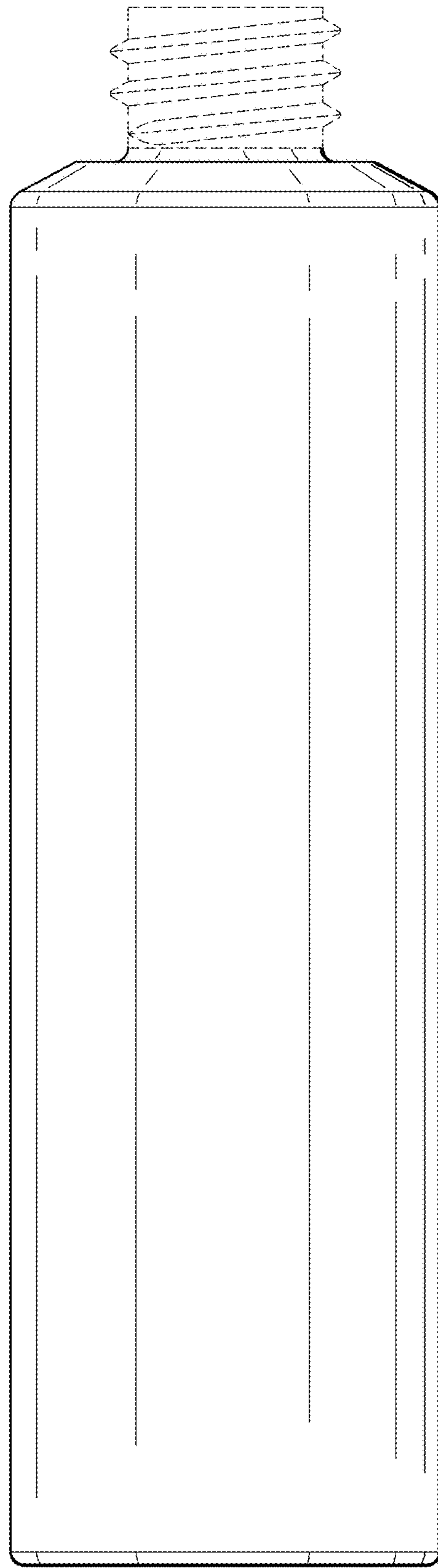

Fig. 12

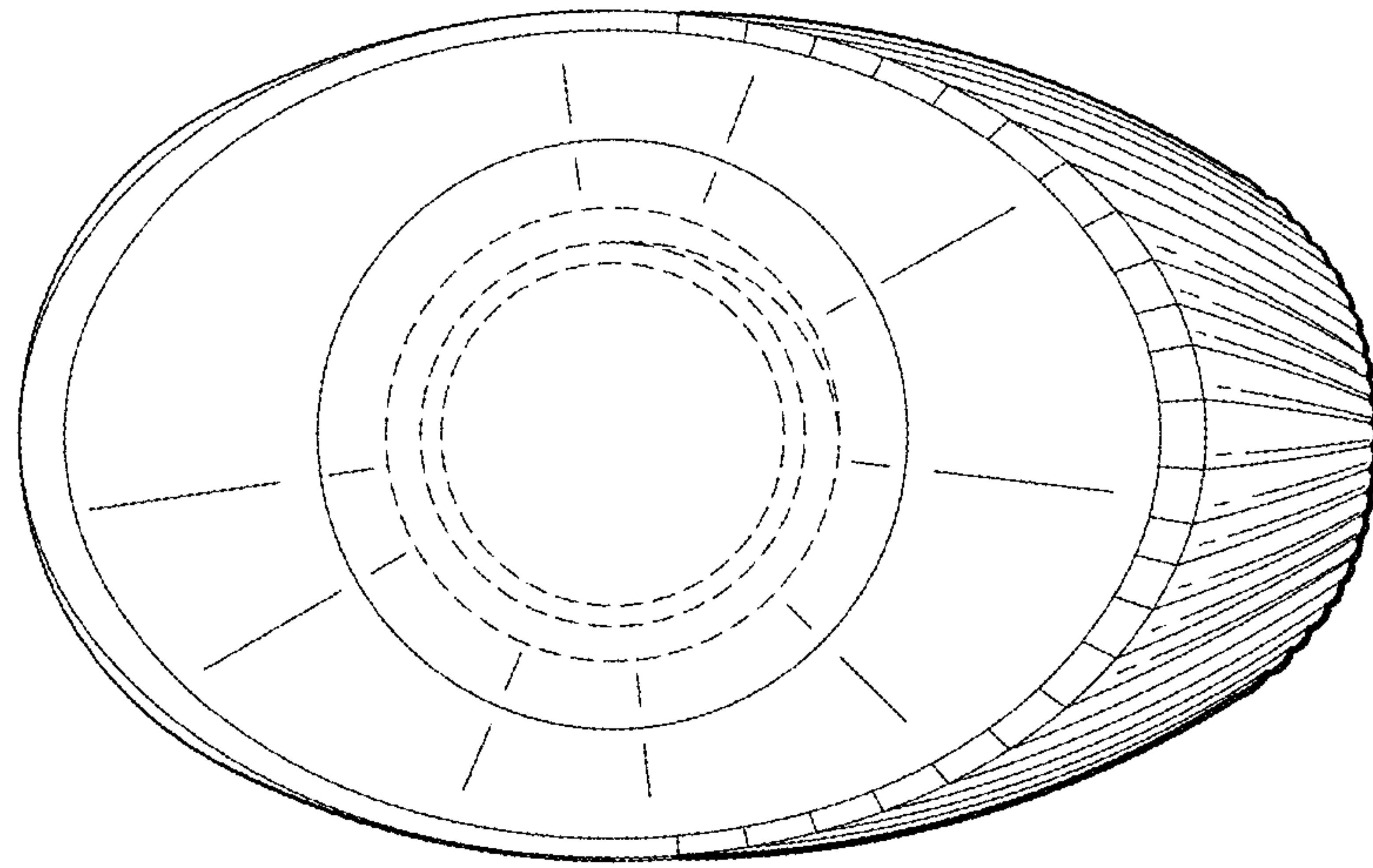

Fig. 13

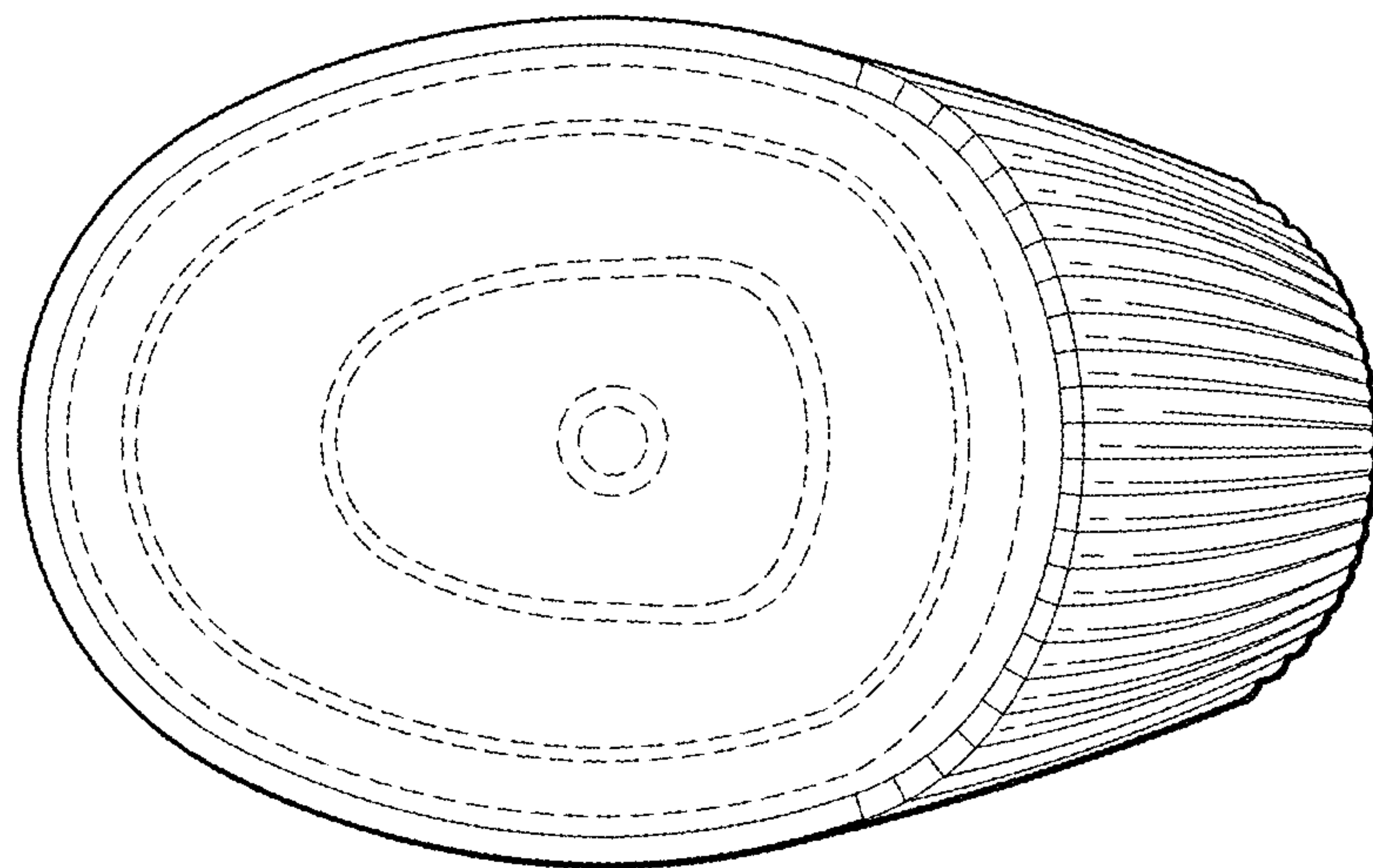

Fig. 14

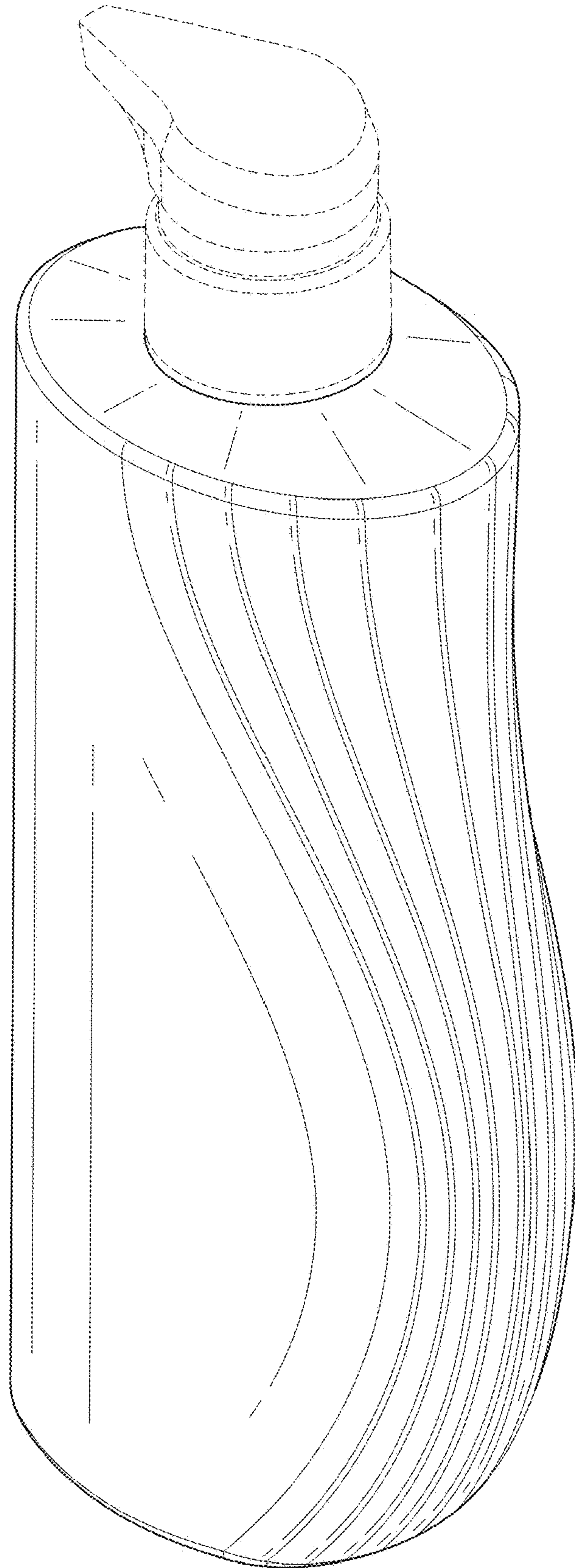

Fig. 15

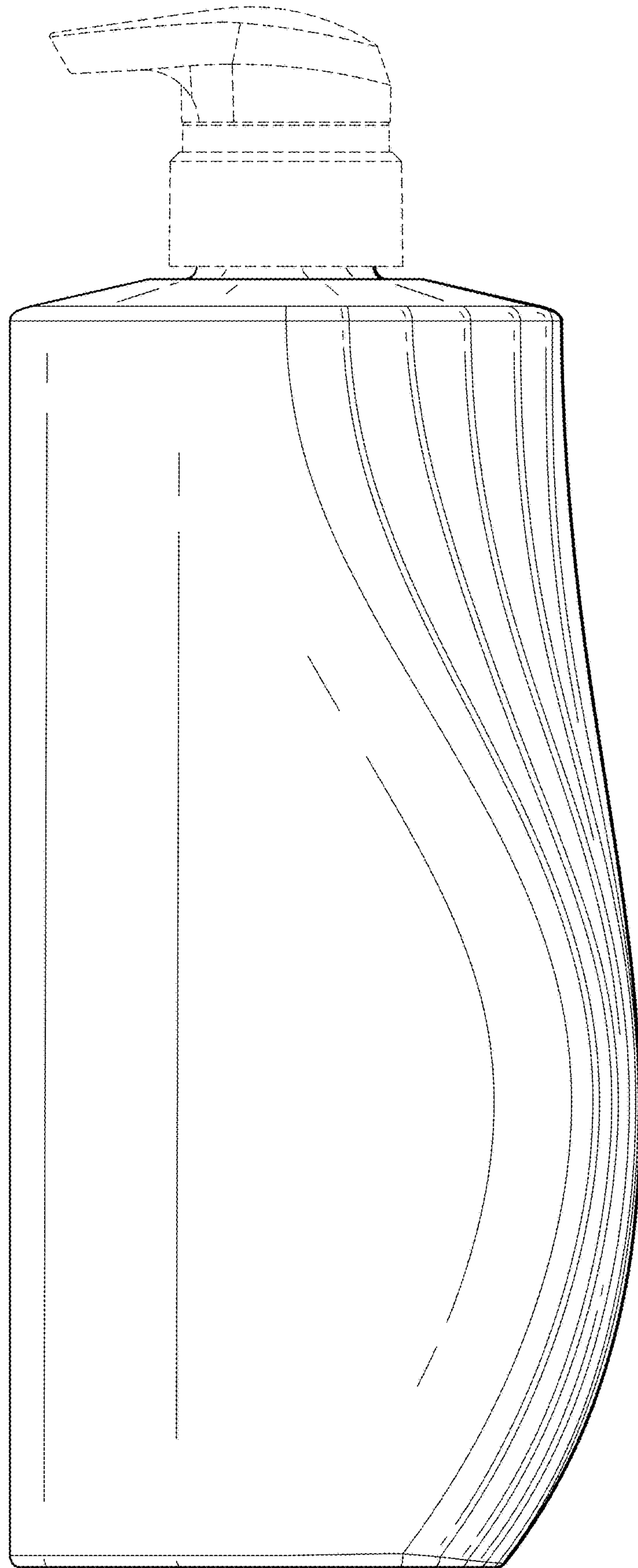

Fig. 16

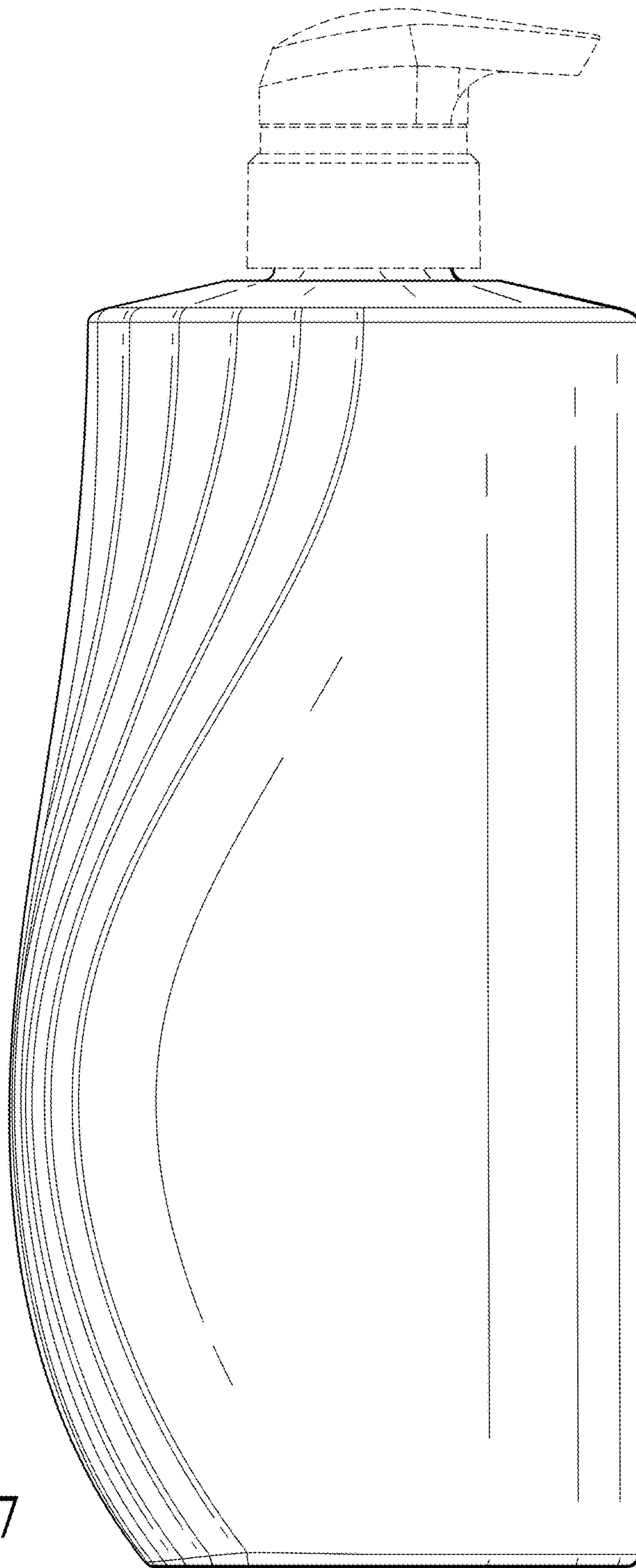

Fig. 17

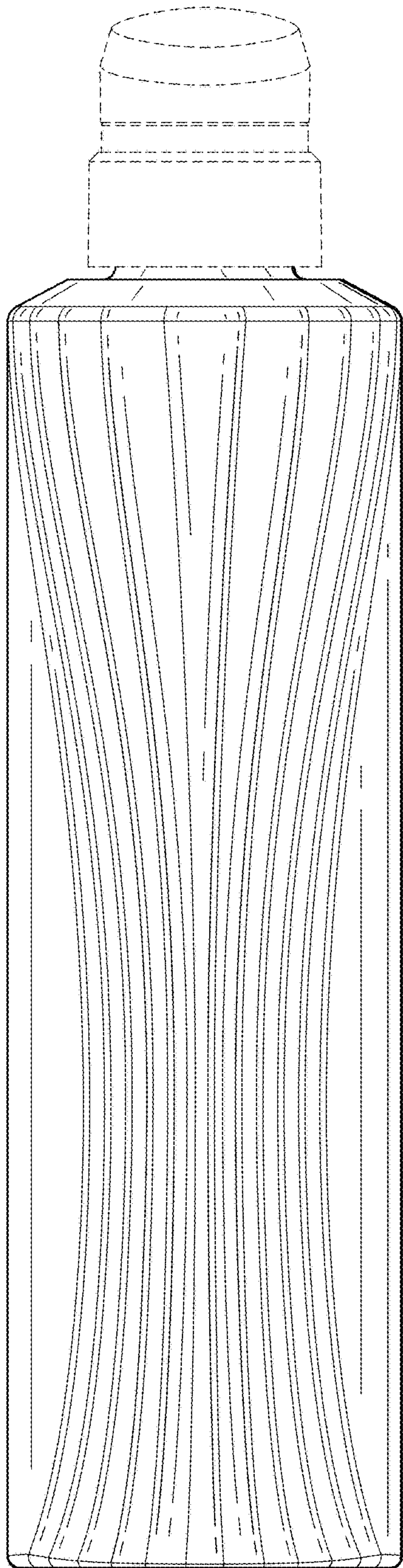

Fig. 18

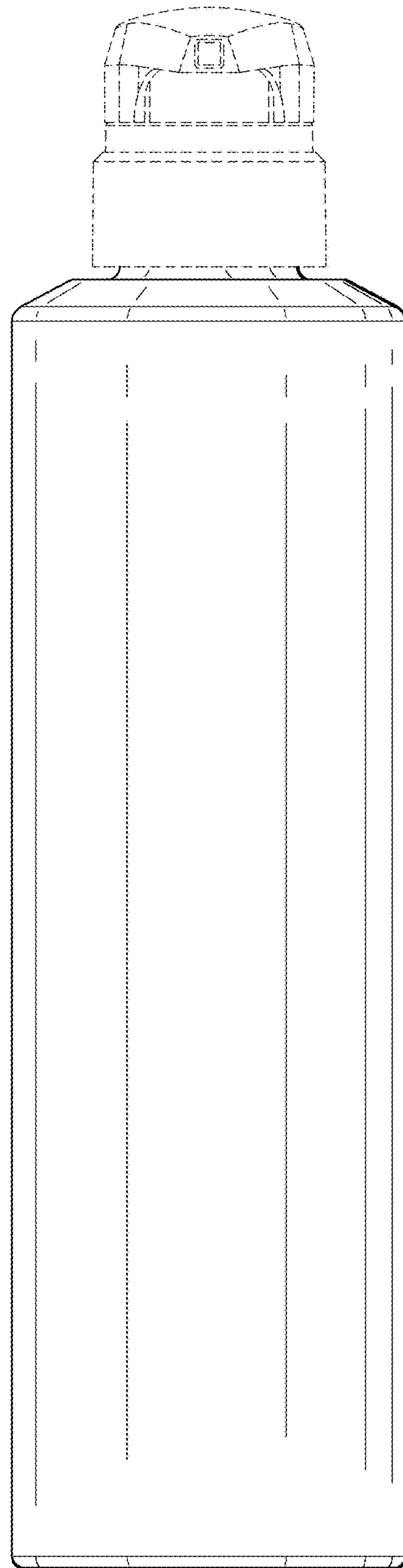

Fig. 19

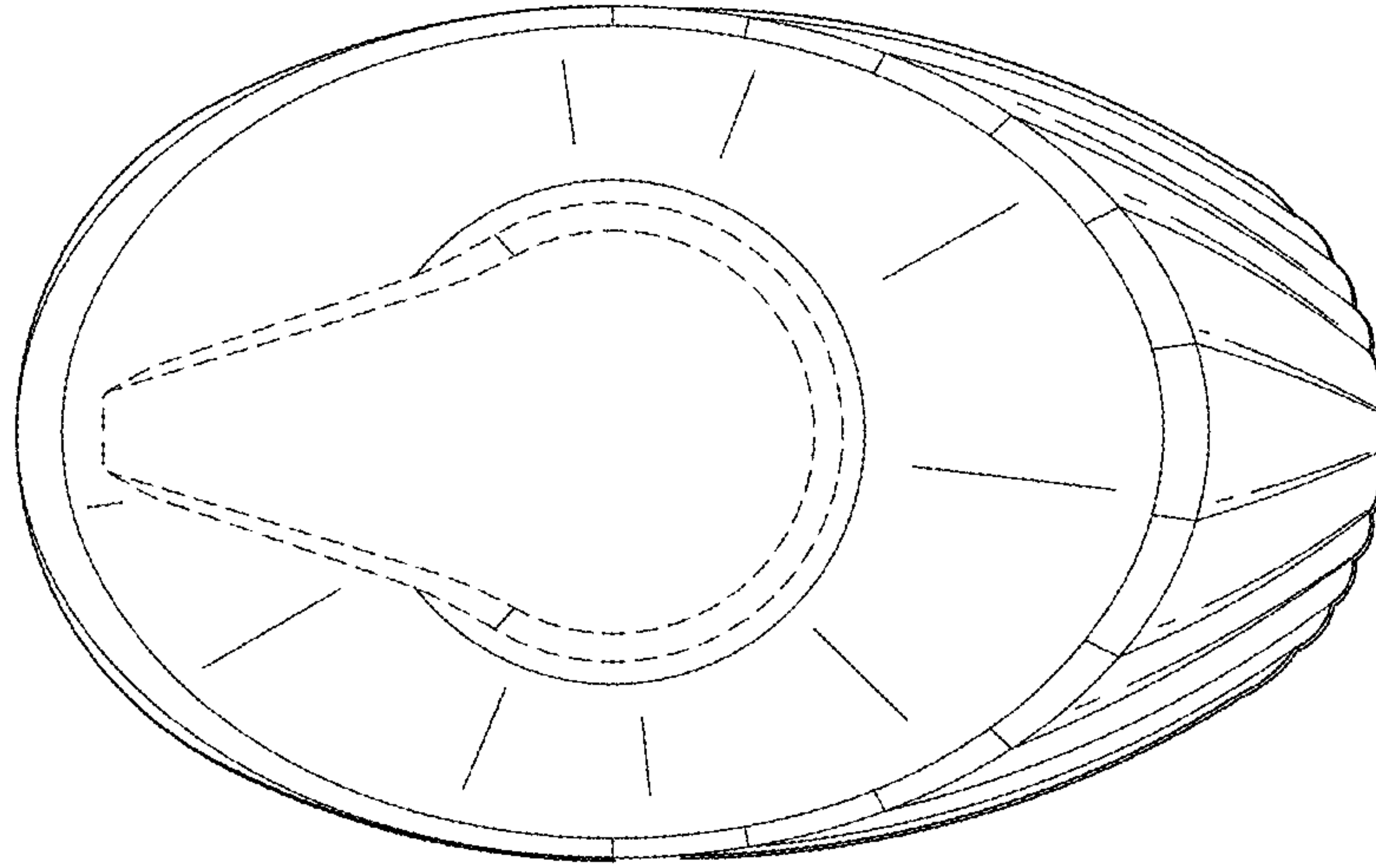

Fig. 20

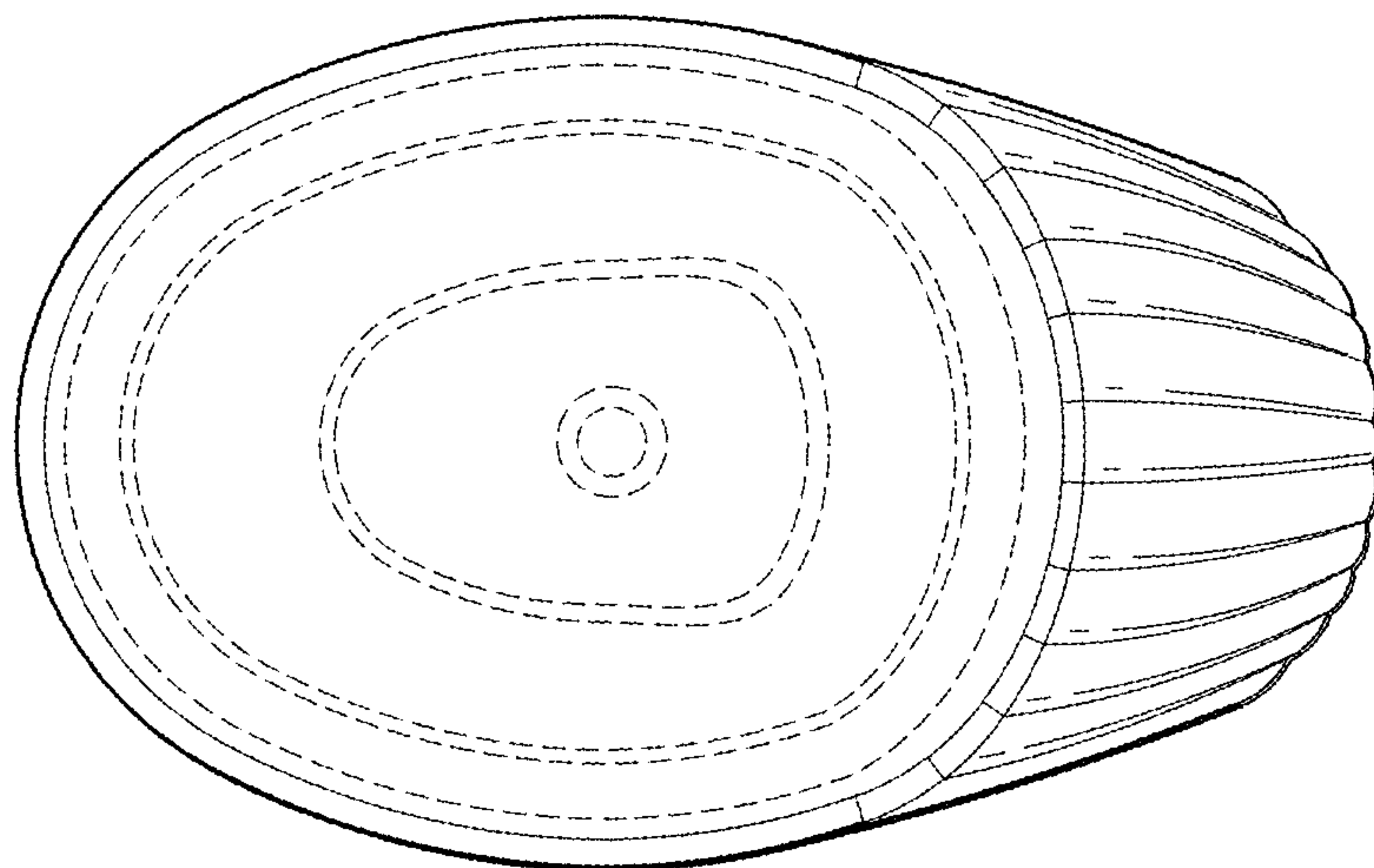

Fig. 21

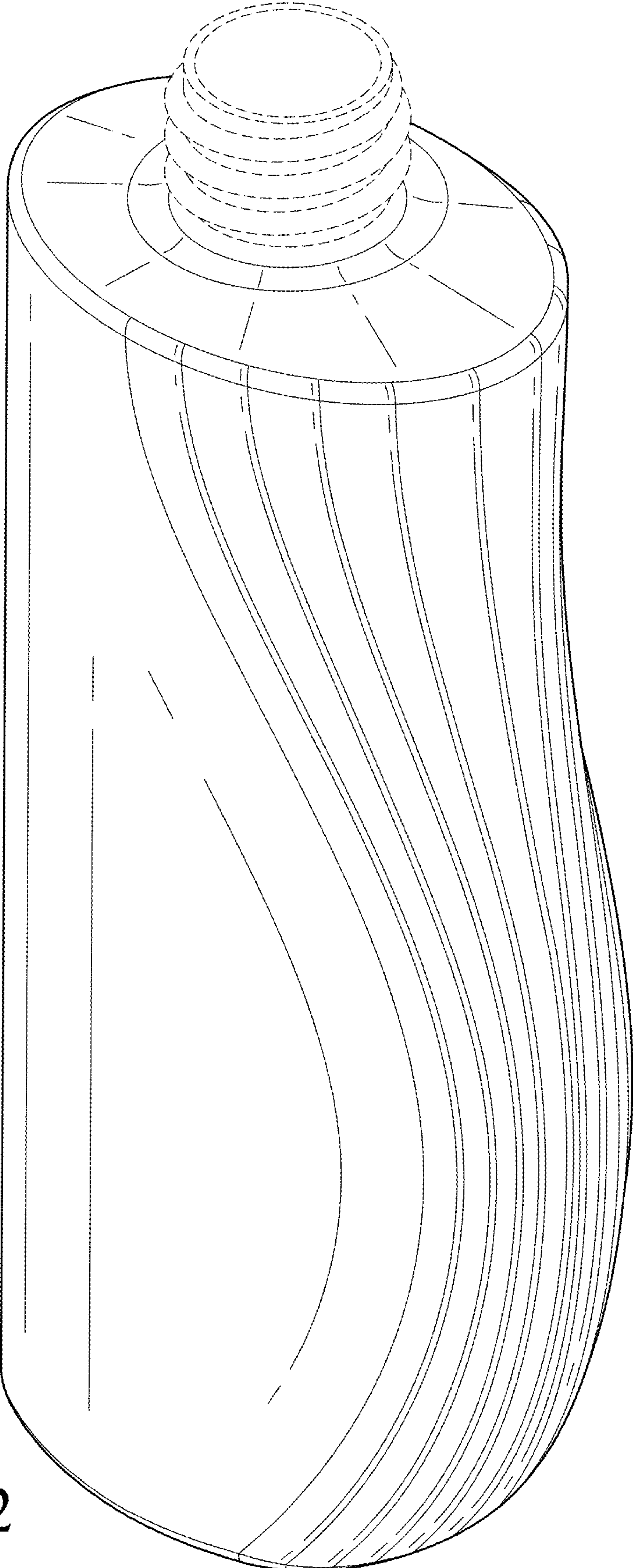

Fig. 22

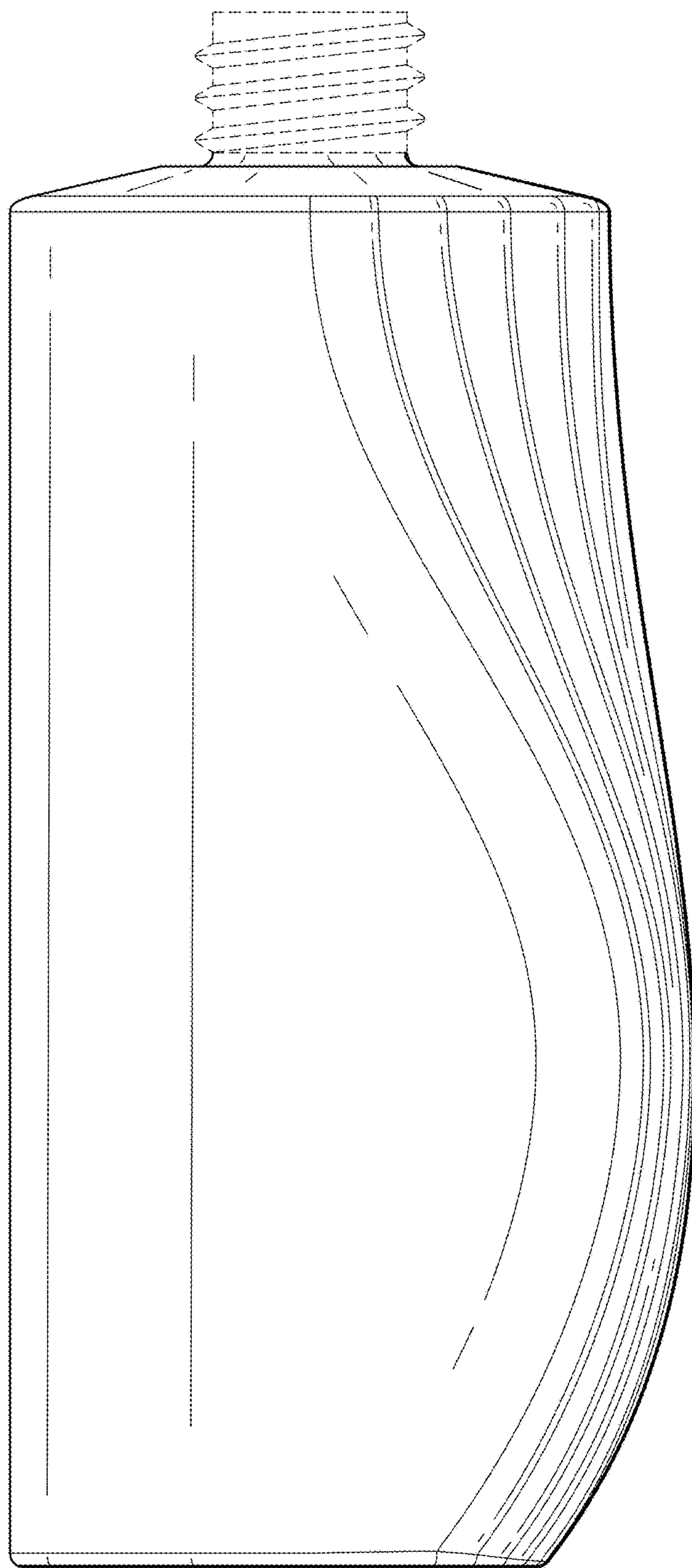

Fig. 23

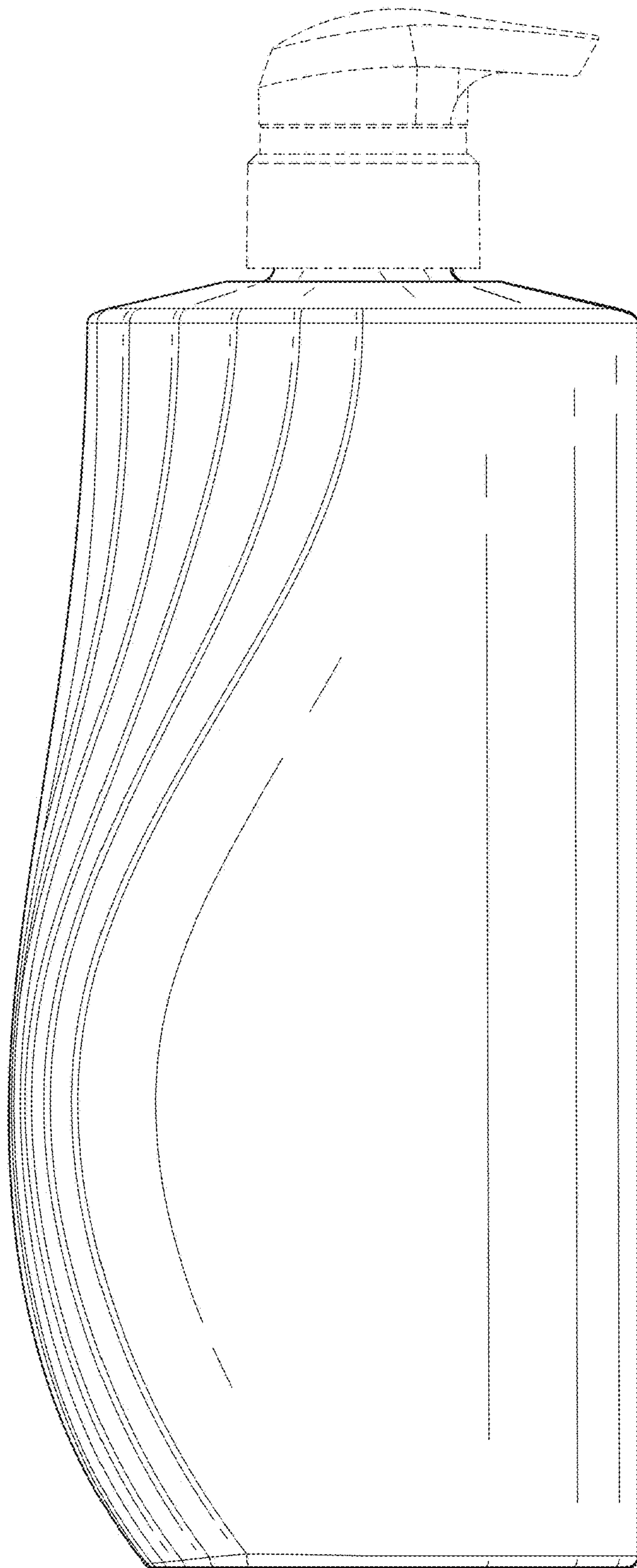

Fig. 24

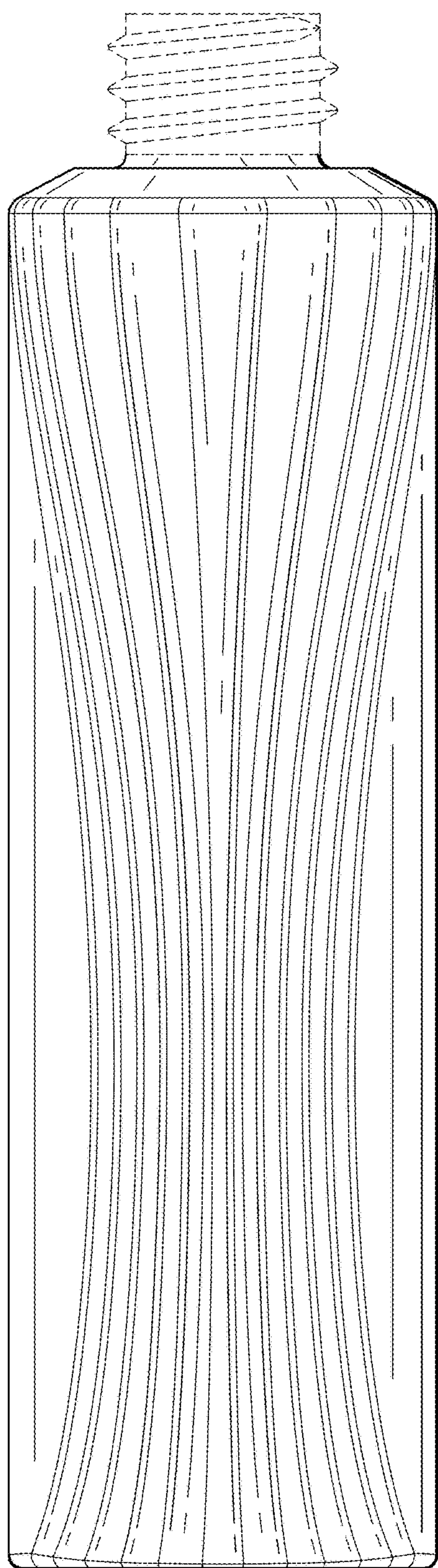

Fig. 25

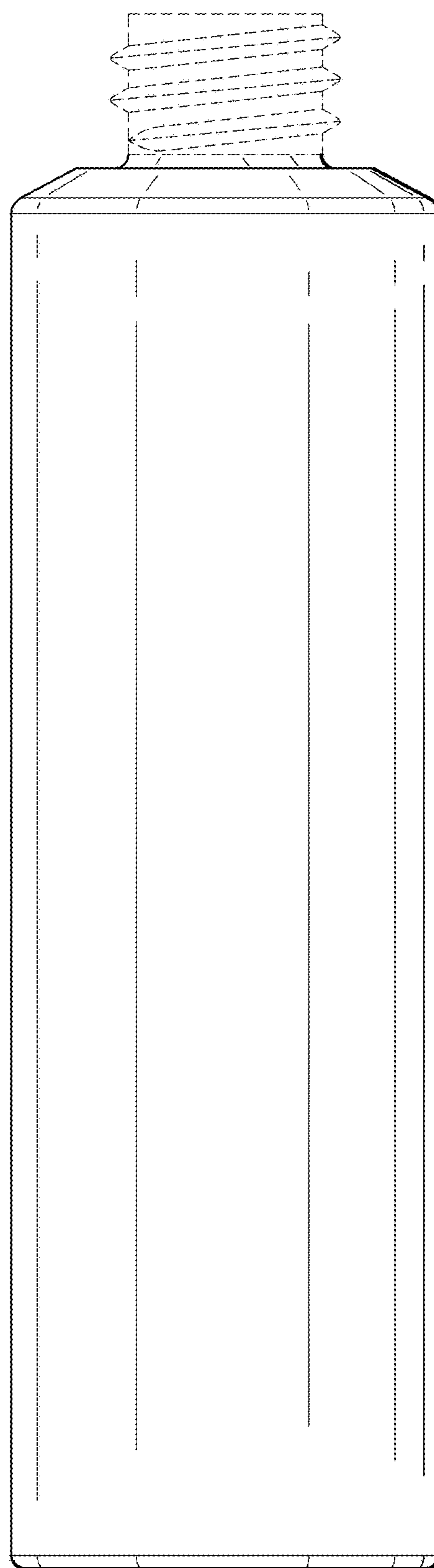

Fig. 26

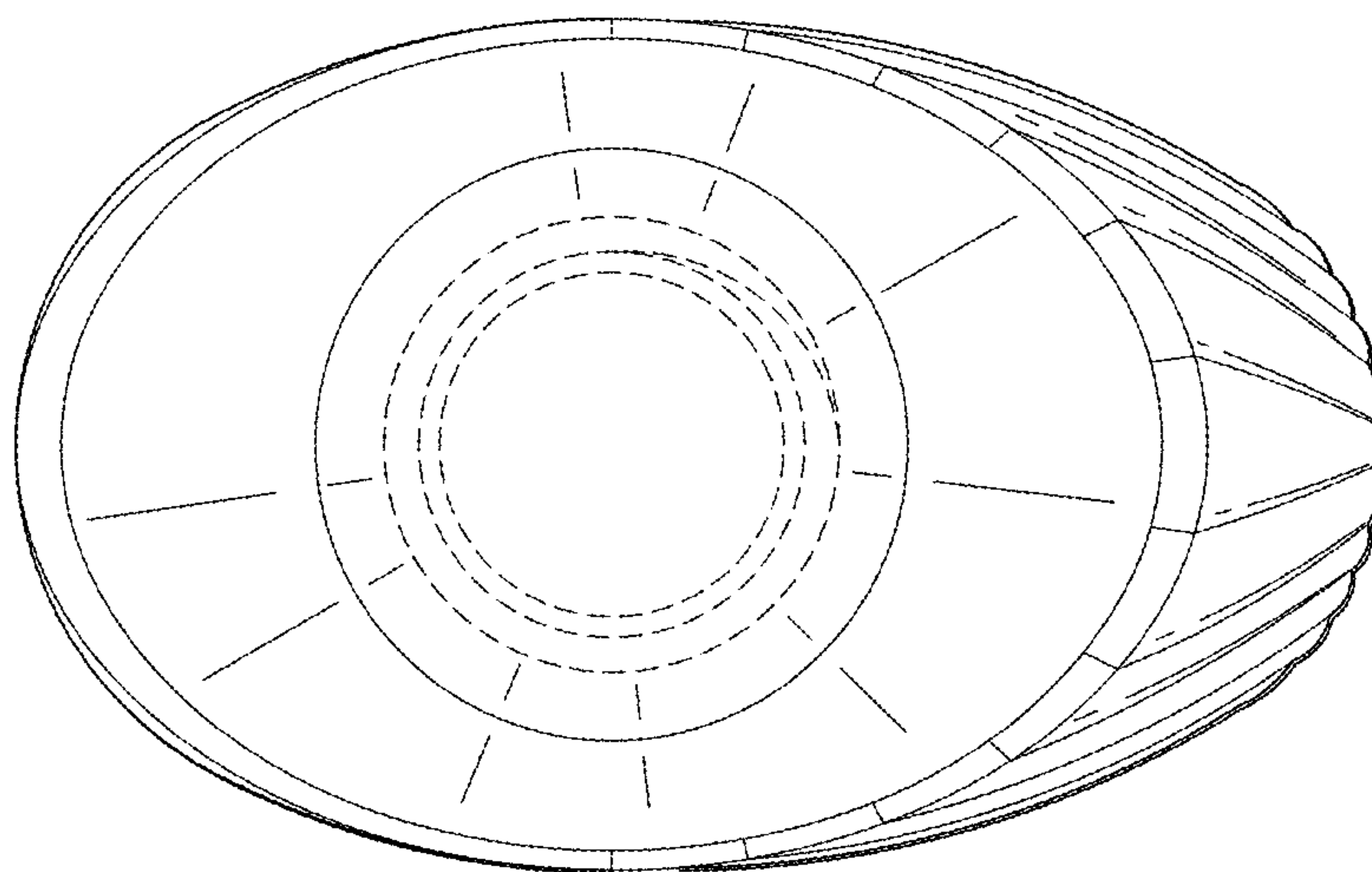

Fig. 27

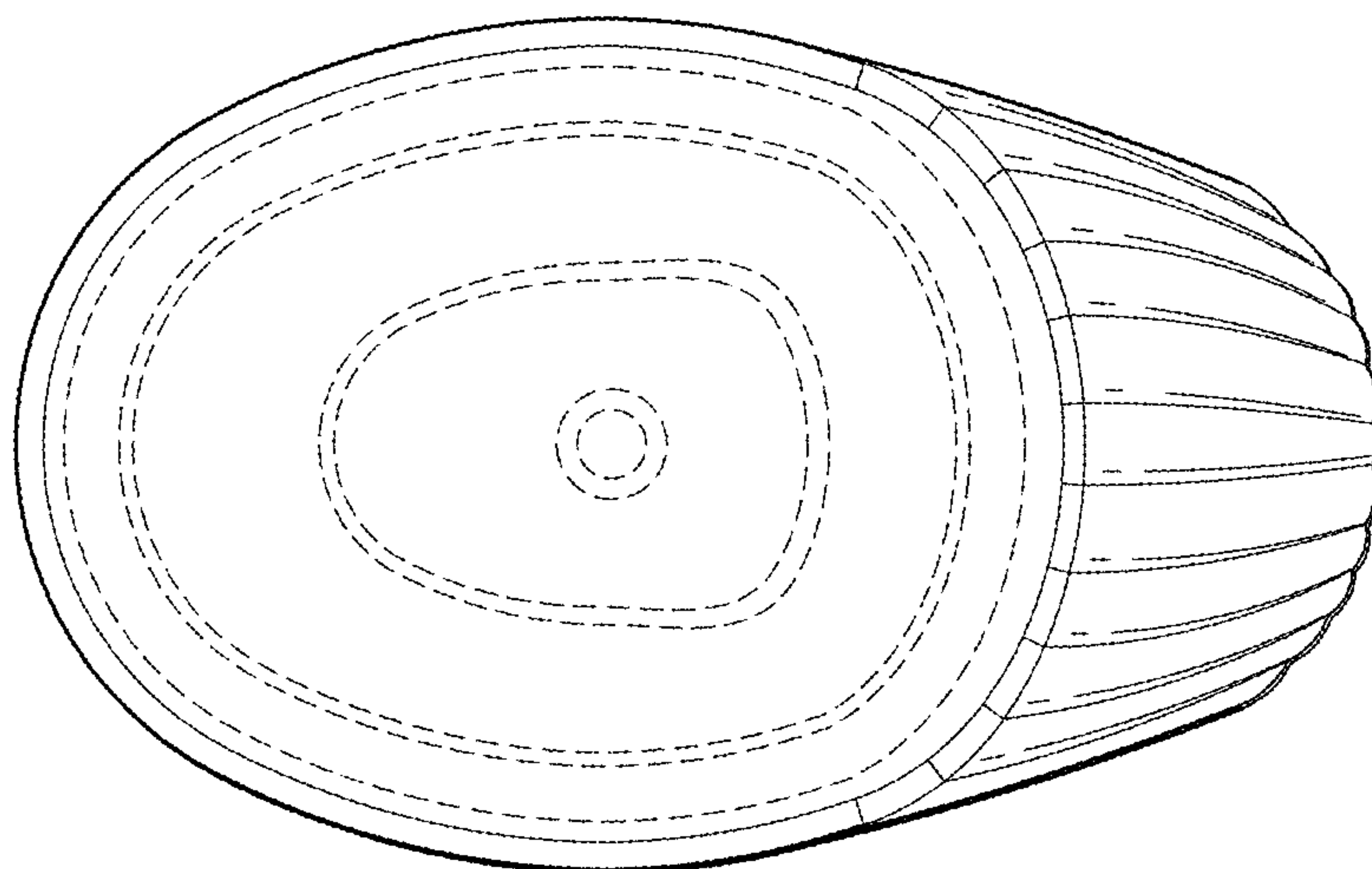

Fig. 28