

US00D840824S

(12) **United States Design Patent**
Bore

(10) **Patent No.:** **US D840,824 S**

(45) **Date of Patent:** **** Feb. 19, 2019**

(54) **BOTTLE**

(71) Applicant: **Henkel AG & Co. KGaA**, Duesseldorf (DE)

(72) Inventor: **Olivier Bore**, Parmain (FR)

(73) Assignee: **Henkel AG & Co. KGaA** (DE)

(**) Term: **15 Years**

(21) Appl. No.: **29/527,575**

(22) Filed: **May 20, 2015**

(30) **Foreign Application Priority Data**

Nov. 27, 2014 (EM) 002586933

(51) **LOC (11) Cl.** **09-01**

(52) **U.S. Cl.**
USPC **D9/544; D9/543**

(58) **Field of Classification Search**
USPC D9/516, 539, 543, 544, 575, 715, 719;
D7/510-513

CPC B65D 1/0223; B65D 2501/0081; B65D
47/128
See application file for complete search history.

(56) **References Cited**

U.S. PATENT DOCUMENTS

D217,227 S * 4/1970 Christianson D9/543
D277,551 S * 2/1985 Kerr 215/382
D308,631 S * 6/1990 Burns D9/520

D340,217 S * 10/1993 Delage D12/114
D353,097 S * 12/1994 Weiss D9/529
D373,086 S * 8/1996 Hirato D9/516
D387,668 S * 12/1997 Bond D9/520
D398,853 S * 9/1998 Phillips D9/526
D418,425 S * 1/2000 Gobe D9/516
D419,057 S * 1/2000 Gobe D9/521
D444,387 S * 7/2001 Adachi D9/520
D481,954 S * 11/2003 Potts D9/538
D491,470 S * 6/2004 Yang D9/544
D576,495 S * 9/2008 Slubski D9/537
D651,516 S * 1/2012 Schaeffer D9/522
D714,647 S * 10/2014 Kersten D9/445
D766,092 S * 9/2016 Maillet D9/544
D777,518 S * 1/2017 Frazier D7/510

* cited by examiner

Primary Examiner — Ian Simmons

Assistant Examiner — Keith Frank

(74) *Attorney, Agent, or Firm* — James J. Cummings

(57) **CLAIM**

The ornamental design for a bottle, as shown and described.

DESCRIPTION

FIG. 1 is a front perspective view of a bottle embodying our new design, the bottle having a transparent outer surface; FIG. 2 is a front side elevation view thereof; FIG. 3 is a rear side elevation view thereof; FIG. 4 is a left side elevation view thereof; FIG. 5 is a right side elevation view thereof; FIG. 6 is a top plan view thereof; and, FIG. 7 is a bottom plan view thereof.

1 Claim, 7 Drawing Sheets

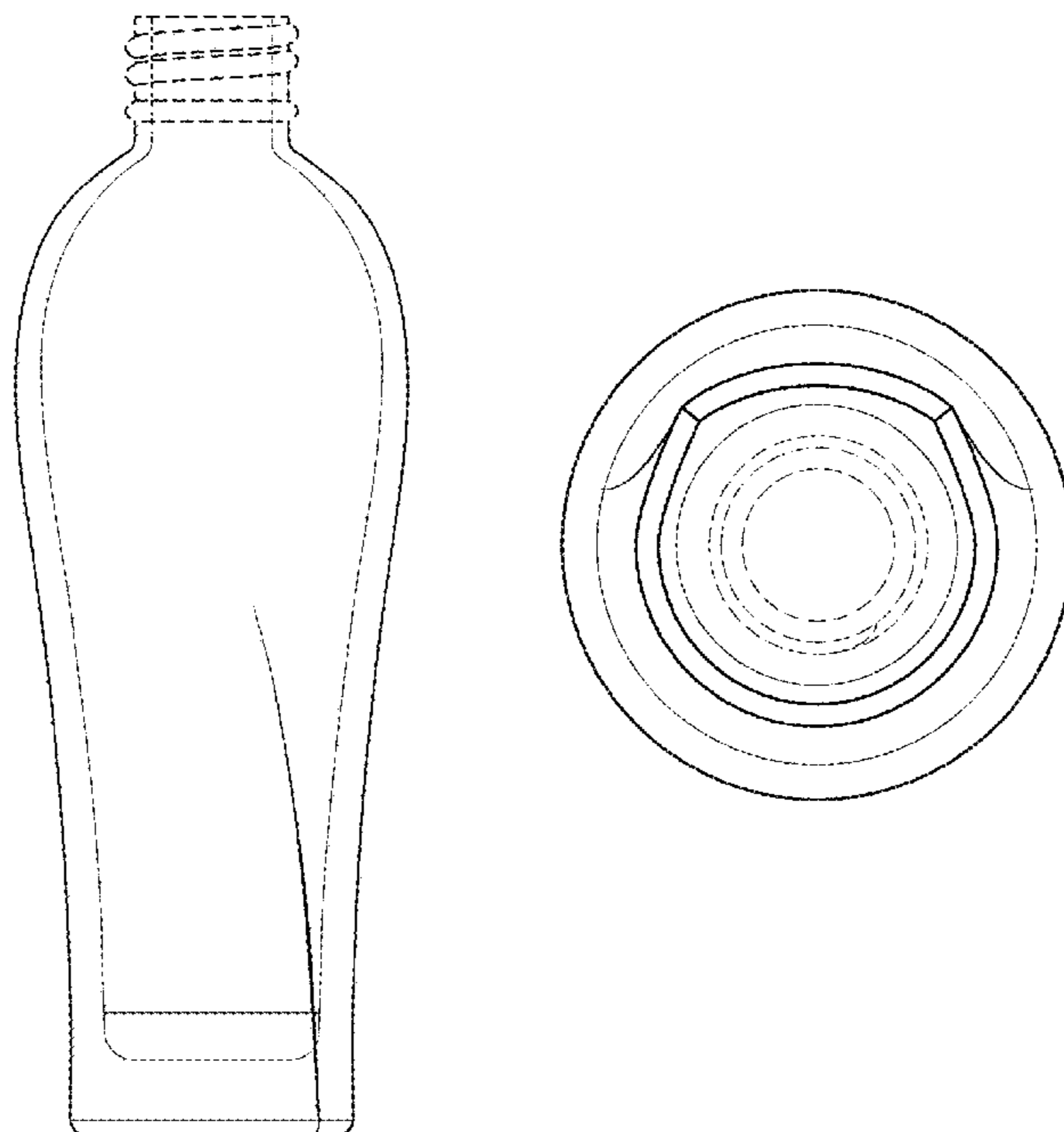

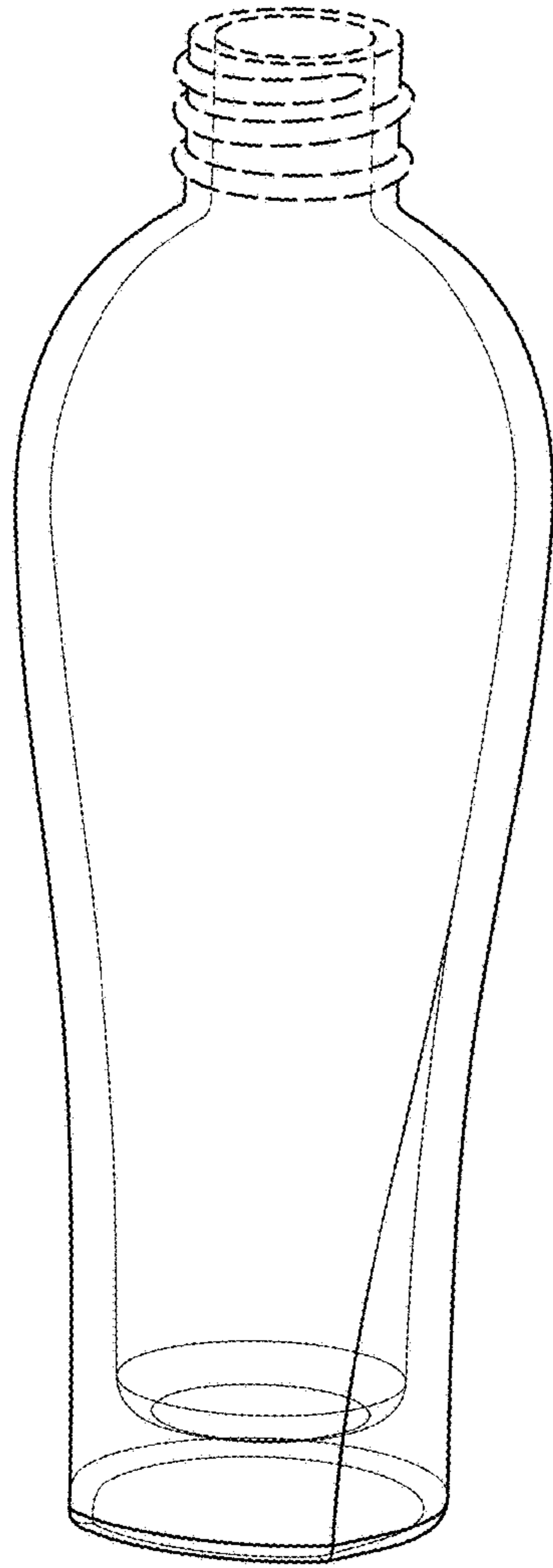

FIG. 1

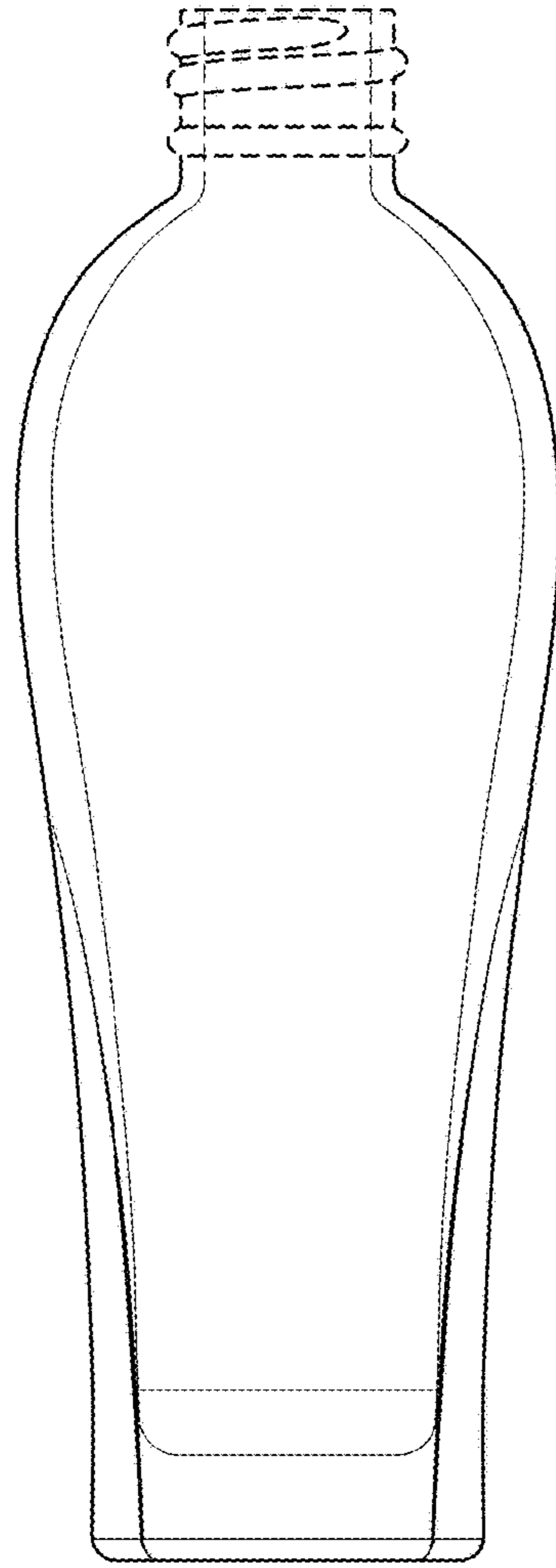

FIG. 2

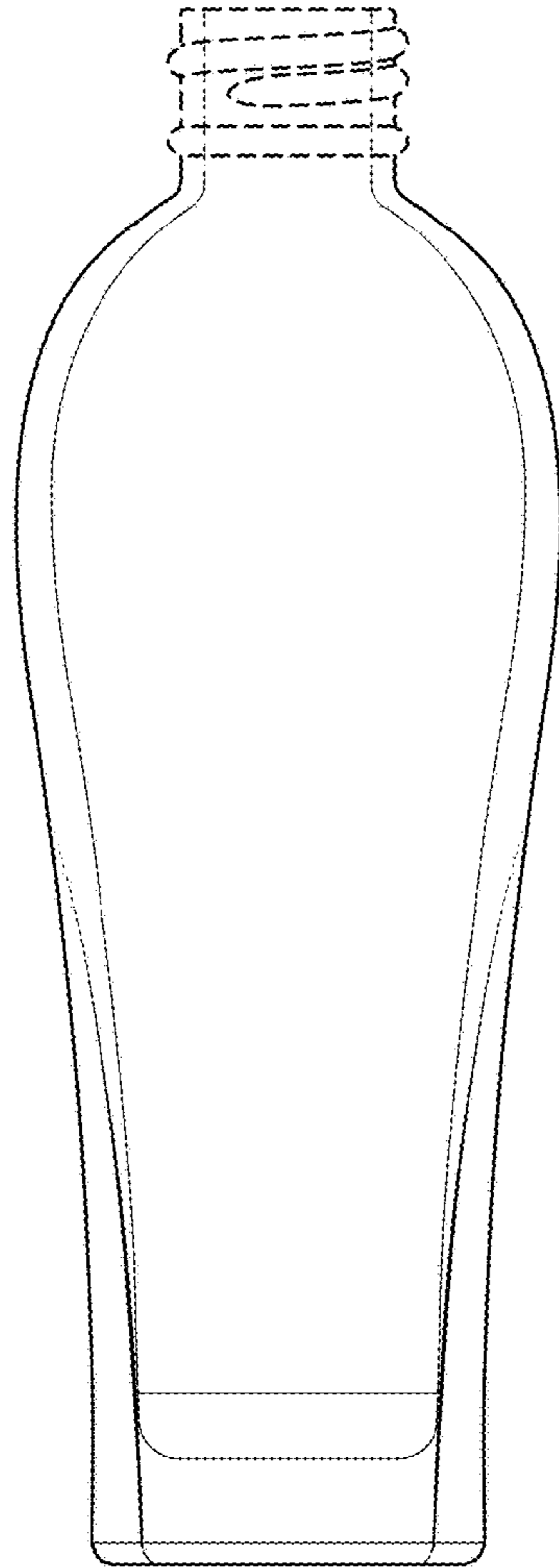

FIG.3

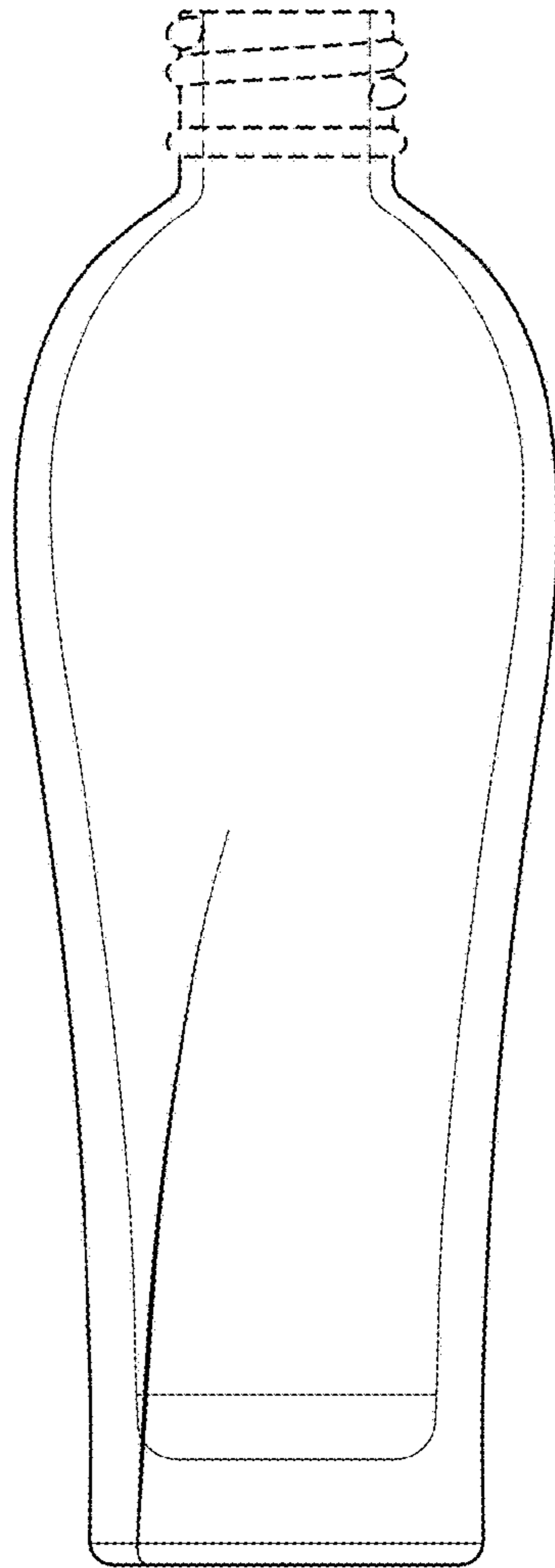

FIG. 4

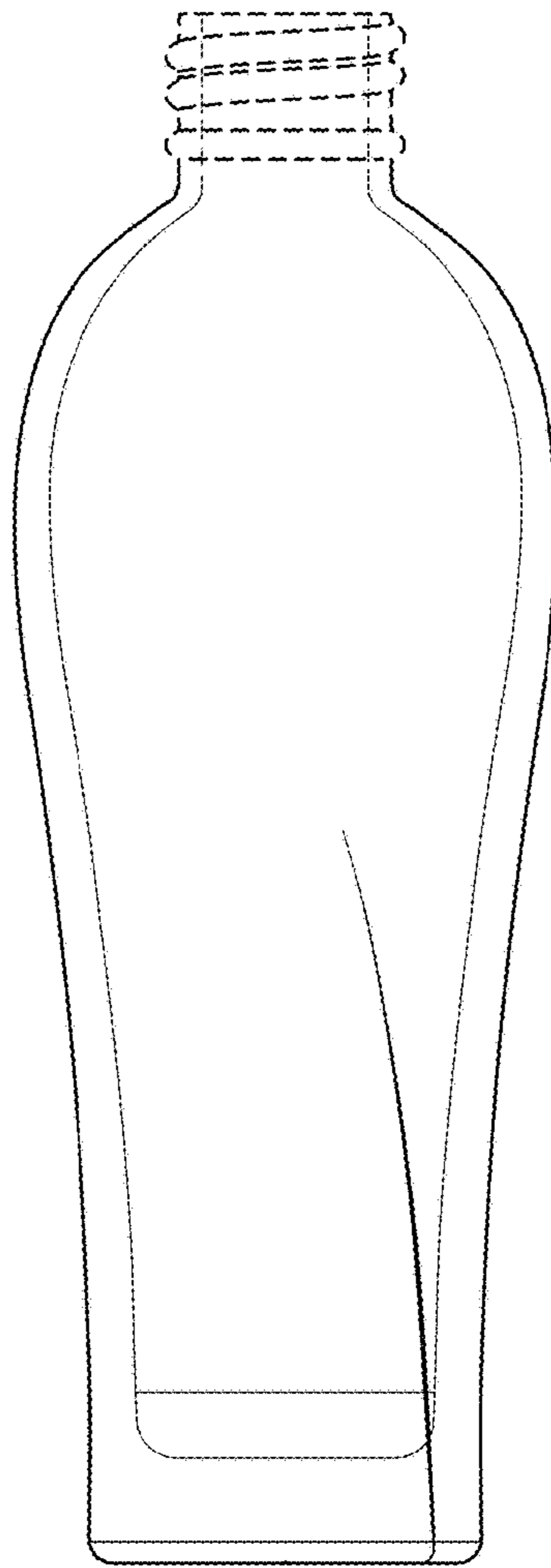

FIG. 5

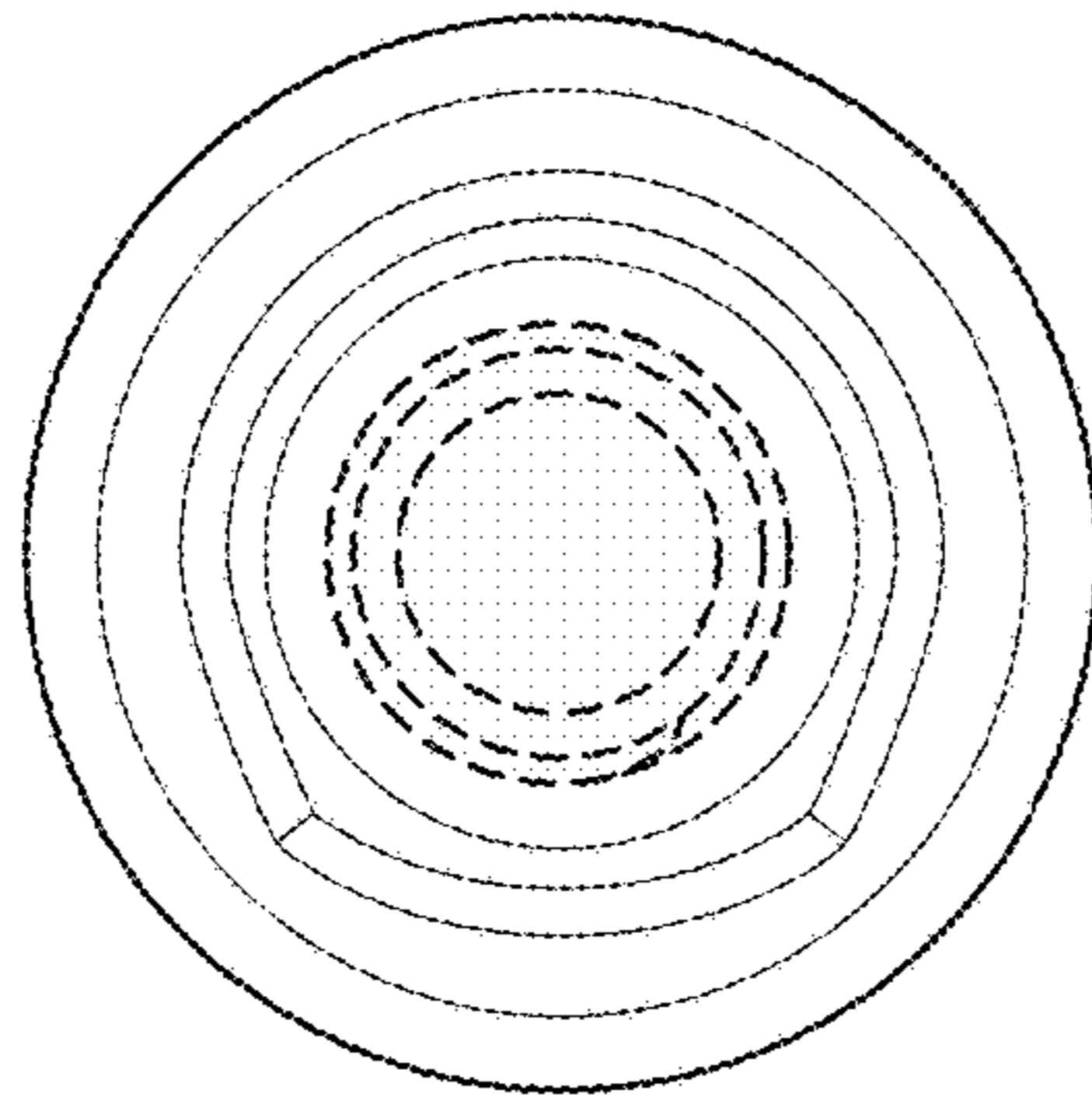

FIG.6

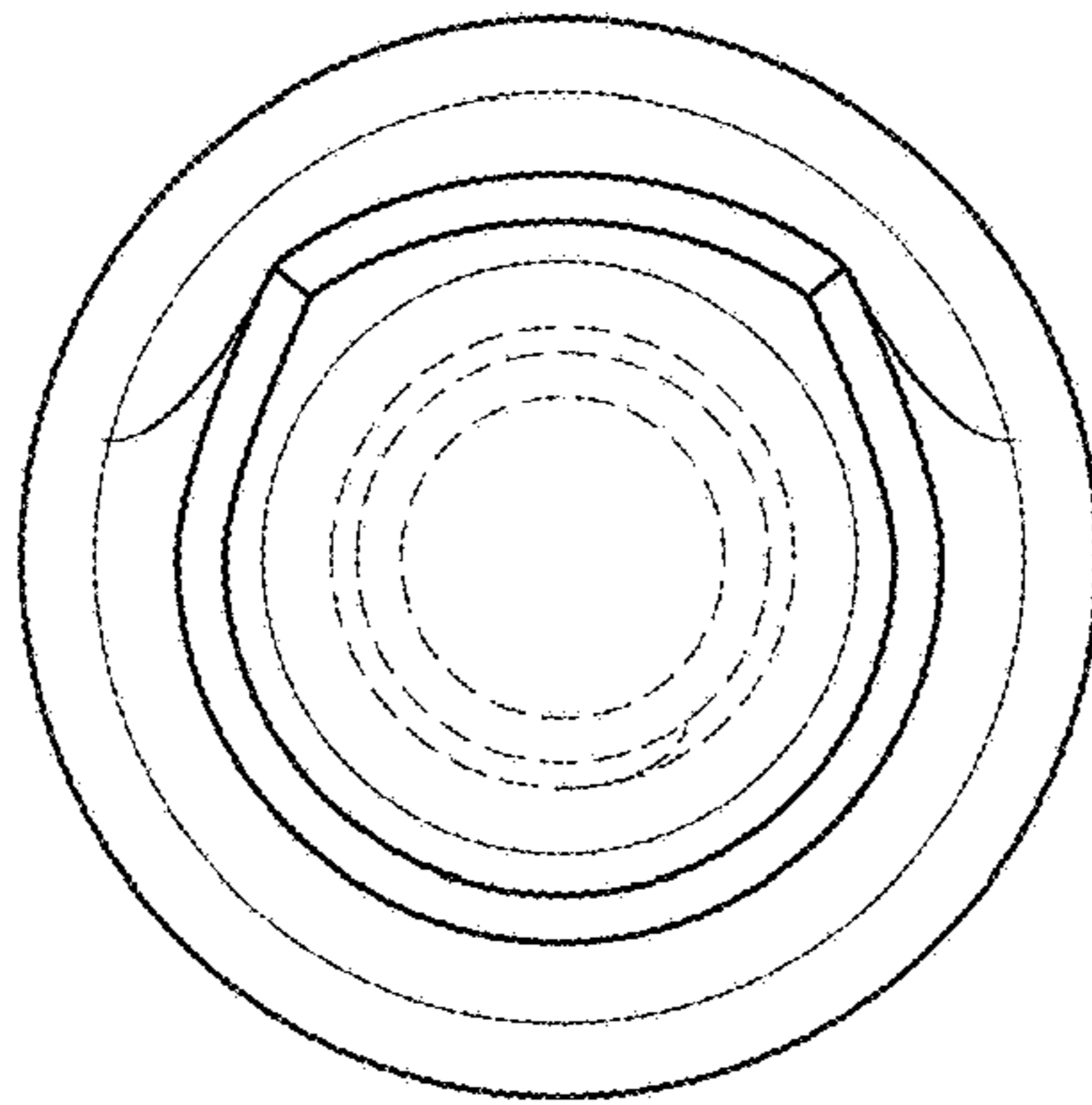

FIG.7