



US00D840676S

(12) **United States Design Patent**
Woodard et al.

(10) **Patent No.:** **US D840,676 S**

(45) **Date of Patent:** **** Feb. 19, 2019**

(54) **KIT BAG**

(71) Applicant: **WATER PIK, INC.**, Fort Collins, CO
(US)

(72) Inventors: **Brian Woodard**, Fort Collins, CO
(US); **Roy Swanson**, Denver, CO (US)

(73) Assignee: **WATER PIK, INC.**, Fort Collins, CO
(US)

(**) Term: **15 Years**

(21) Appl. No.: **29/648,900**

(22) Filed: **May 24, 2018**

Related U.S. Application Data

(63) Continuation-in-part of application No. 29/552,691,
filed on Jan. 25, 2016, now Pat. No. Des. 819,956.

(51) **LOC (11) Cl.** **03-01**

(52) **U.S. Cl.**
USPC **D3/203.6**

(58) **Field of Classification Search**
USPC D3/200, 201, 203.1, 203.5, 203.6, 232,
D3/245, 252, 301, 303
CPC A45C 1/024; A45C 5/005; A45C 11/008;
A45C 11/00; A45C 2200/20; A45C
2011/007; A45C 2003/008; A45D 44/18;
A45D 2200/25; B65D 81/38
See application file for complete search history.

(56) **References Cited**

U.S. PATENT DOCUMENTS

- 2,597,194 A * 5/1952 Sholl A45C 11/008
190/111
- D280,864 S * 10/1985 Allen D3/283
- D292,645 S * 11/1987 Young D3/245
- D377,861 S * 2/1997 Jacober D3/203.1
- D378,709 S * 4/1997 Jacobs D3/233

- D386,300 S * 11/1997 Kobel D3/217
- 6,047,752 A * 4/2000 Southwick A45C 3/00
150/112
- D425,295 S * 5/2000 Borja D3/203.1
- 6,161,665 A * 12/2000 Hoover A45C 3/00
190/103
- D438,375 S * 3/2001 Terry D3/233
- D451,279 S * 12/2001 Chin D3/301
- D453,416 S * 2/2002 Terry D3/205
- D455,005 S * 4/2002 Wolf D3/205
- D461,046 S * 8/2002 Cohen D3/205
- D494,360 S * 8/2004 Ostermann D3/205
- D512,216 S * 12/2005 Joyce D3/203.6
- D516,306 S * 3/2006 Koenig D3/233
- D557,892 S * 12/2007 Greiner D3/205
- D562,545 S * 2/2008 Dawson D3/203.1
- D565,837 S * 4/2008 Miles D3/203.1
- D576,403 S * 9/2008 Leslie D3/201
- D593,317 S * 6/2009 Yao D3/203.6
- D621,152 S * 8/2010 Lebow D3/203.1
- D657,141 S * 4/2012 Dolce D3/245

(Continued)

Primary Examiner — John Windmuller

Assistant Examiner — Steven J Czyz

(74) *Attorney, Agent, or Firm* — Dorsey & Whitney LLP

(57) **CLAIM**

We claim the ornamental design for a kit bag, as shown and described.

DESCRIPTION

FIG. 1 is a front isometric view of a kit bag.
 FIG. 2 is a front elevation view thereof.
 FIG. 3 is a rear elevation view thereof.
 FIG. 4 is a left side elevation view thereof.
 FIG. 5 is a right side elevation view thereof.
 FIG. 6 is a top plan view thereof; and,
 FIG. 7 is a bottom plan view thereof.
 The broken lines depict portions of the kit bag that form no part of the claimed design.

1 Claim, 4 Drawing Sheets

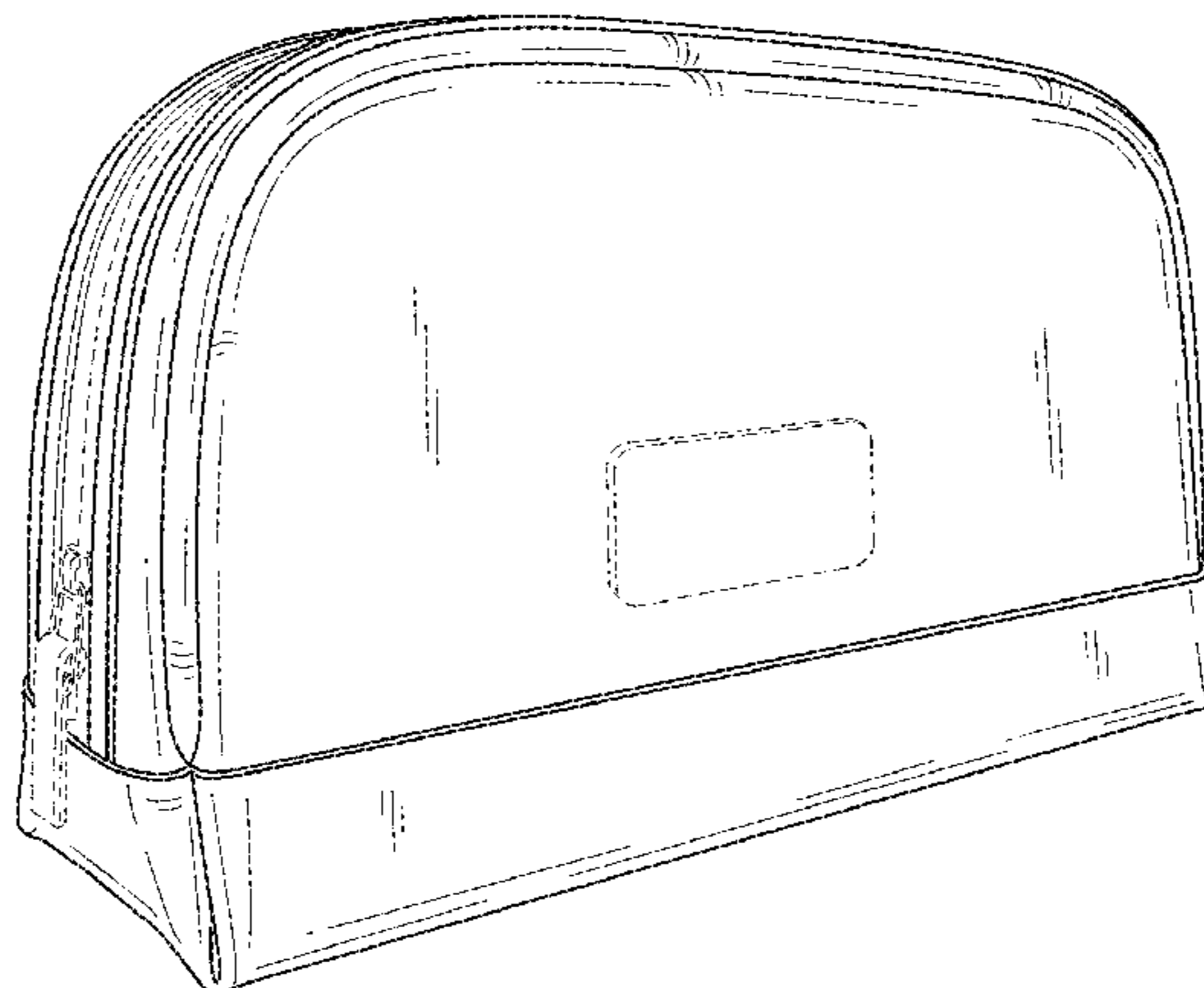

(56)

References Cited

U.S. PATENT DOCUMENTS

D663,944 S *	7/2012	Bouskill	D3/203.1
D690,506 S *	10/2013	Kuster	D3/232
D723,267 S *	3/2015	Basha	D3/232
D723,804 S *	3/2015	Coleman	D3/301
D725,899 S *	4/2015	Wang	D3/232
D739,142 S *	9/2015	Coleman	D3/285
D765,391 S *	9/2016	Dybdahl	D3/205
D778,609 S *	2/2017	Gardner	D3/301
D782,188 S *	3/2017	Tappeiner	D3/245
D790,211 S *	6/2017	Constantini	D3/205
D819,956 S *	6/2018	Woodard	D3/203.6

* cited by examiner

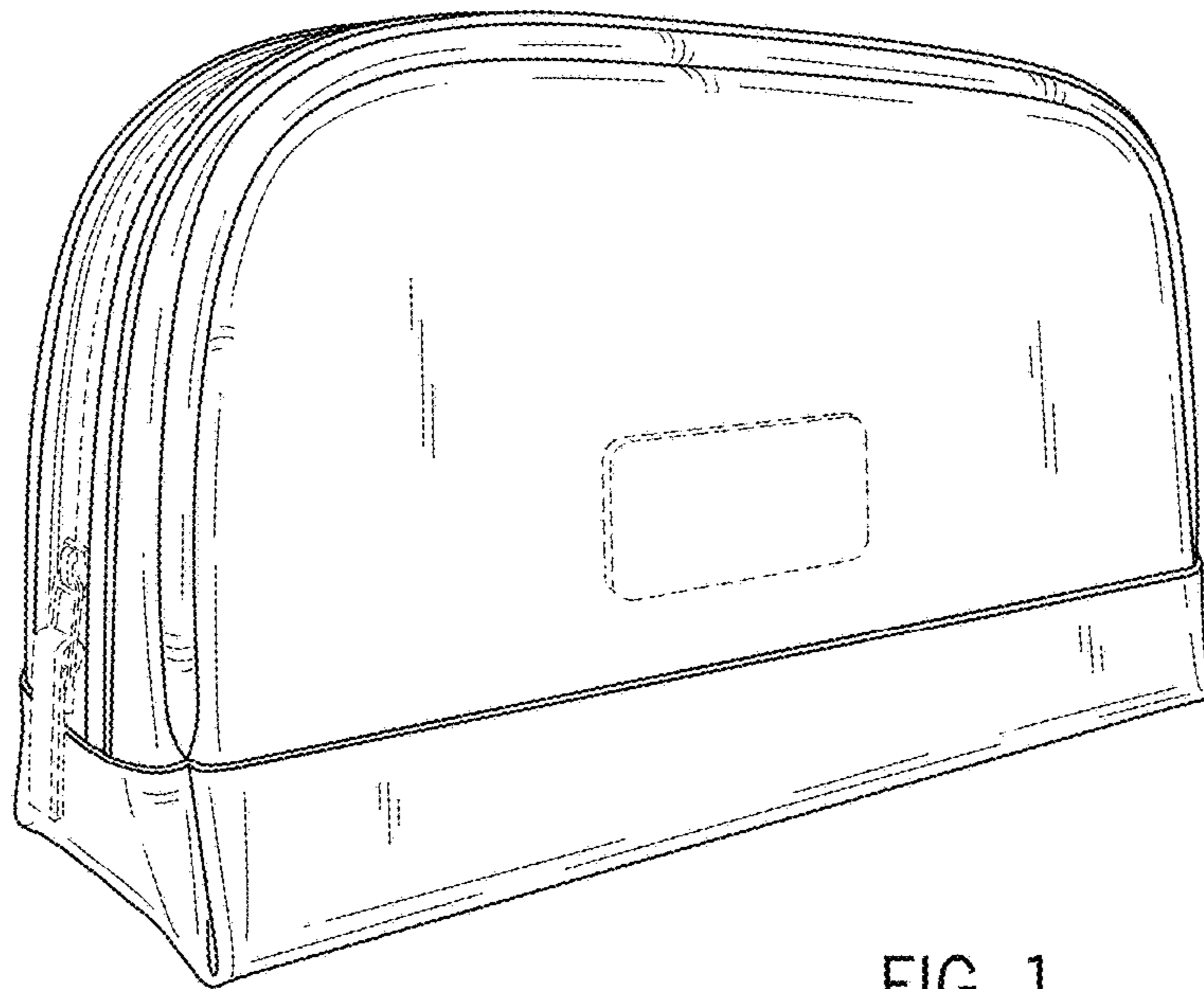

FIG. 1

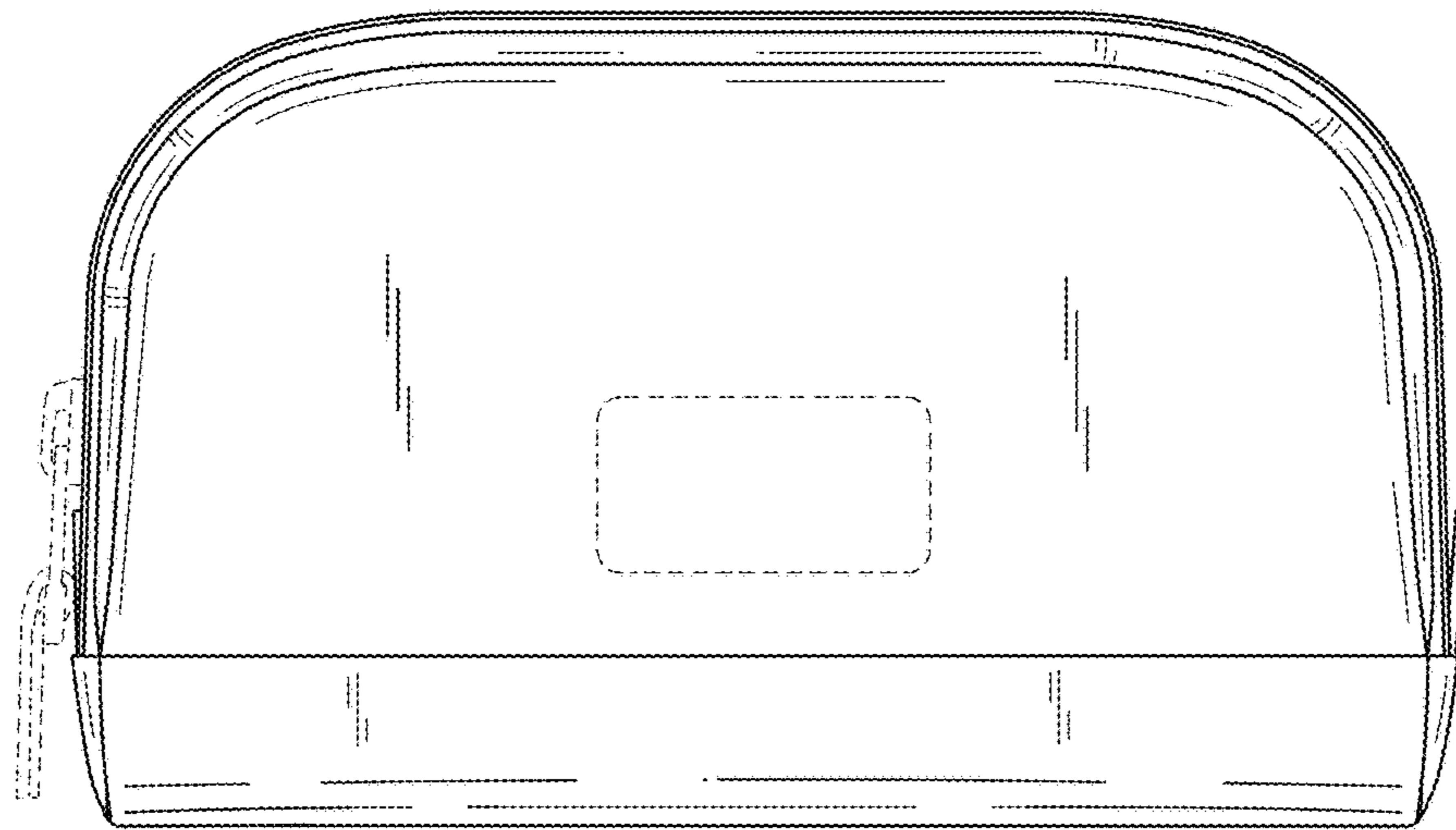

FIG. 2

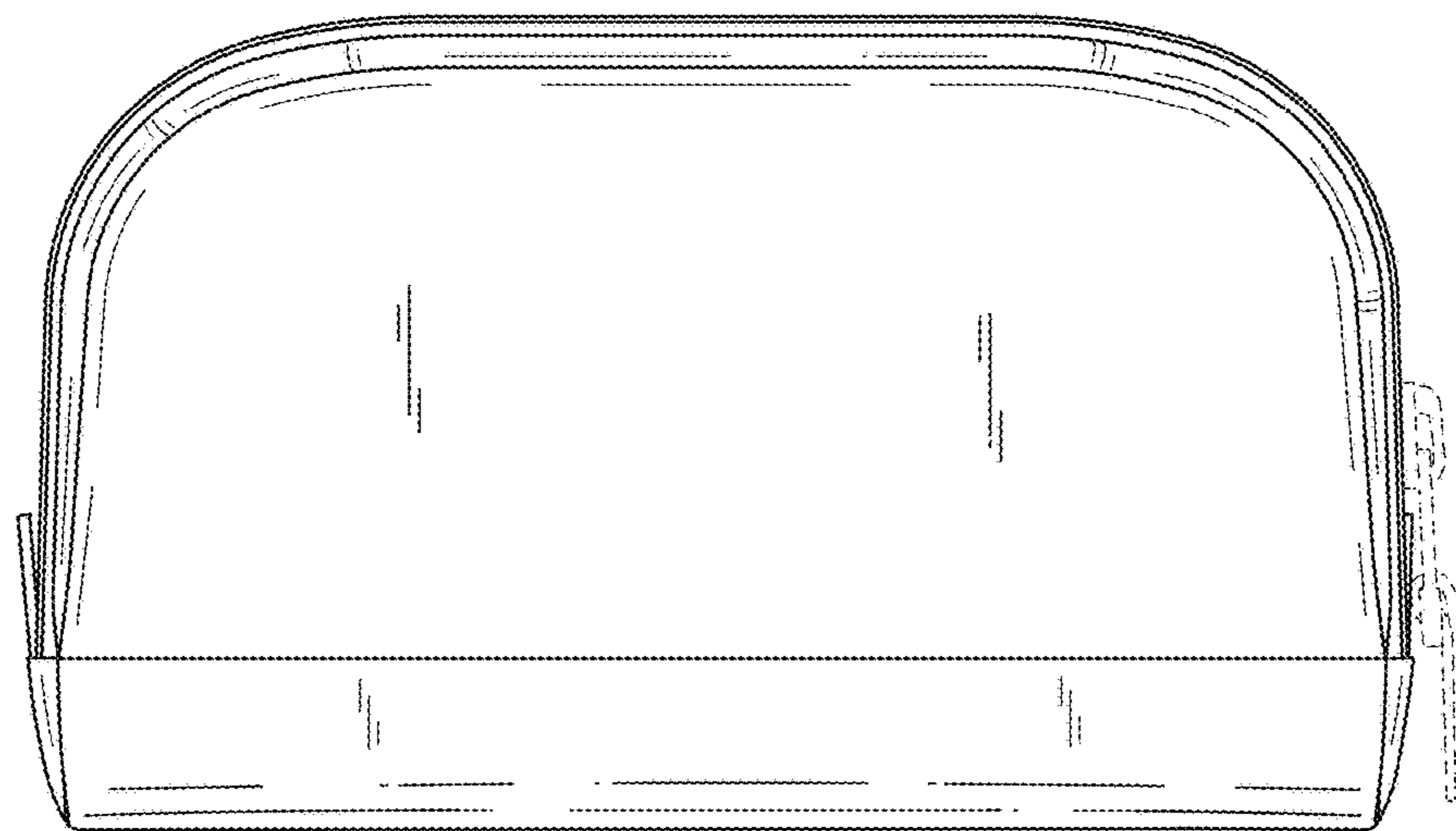

FIG. 3

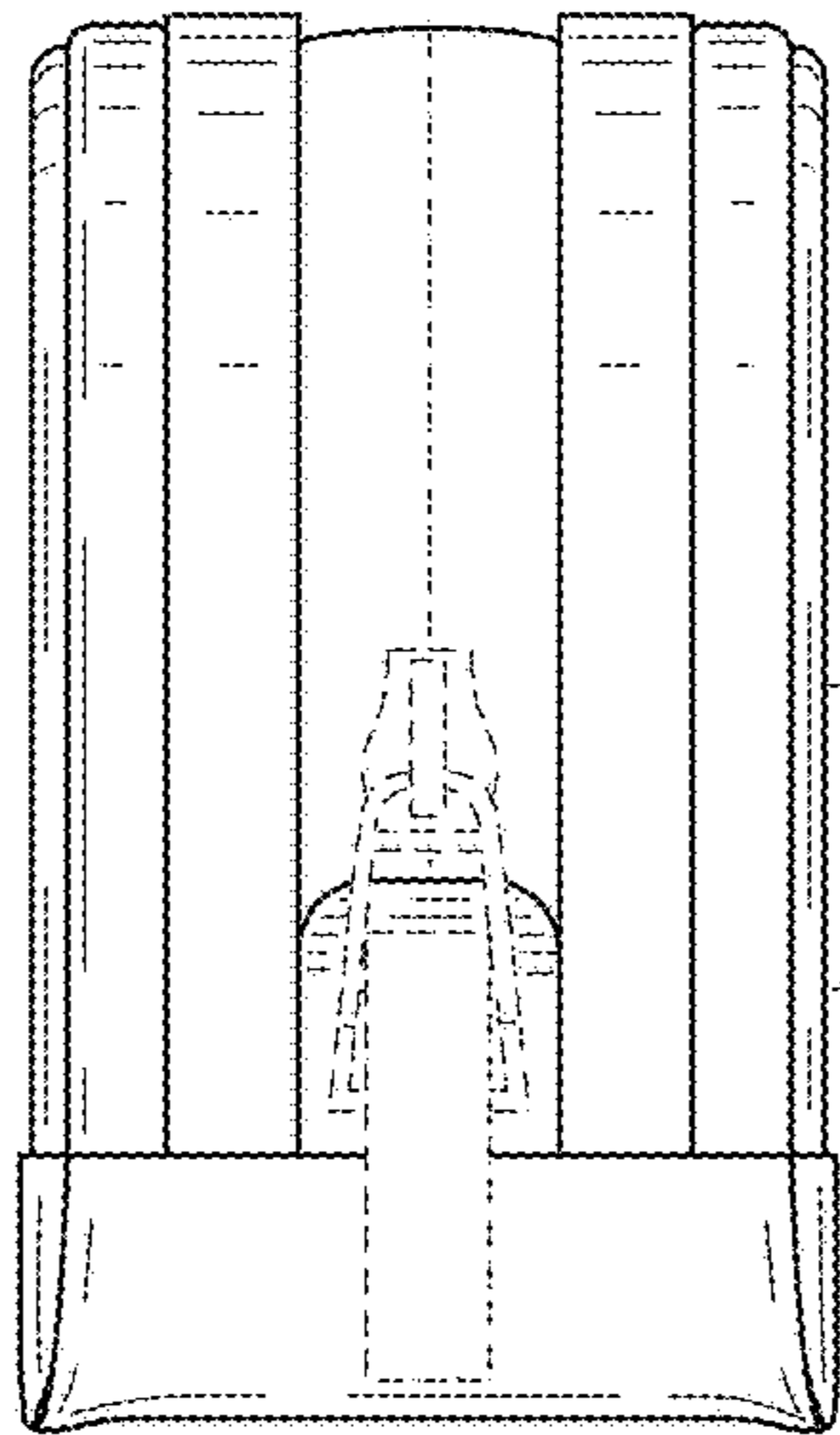

FIG. 4

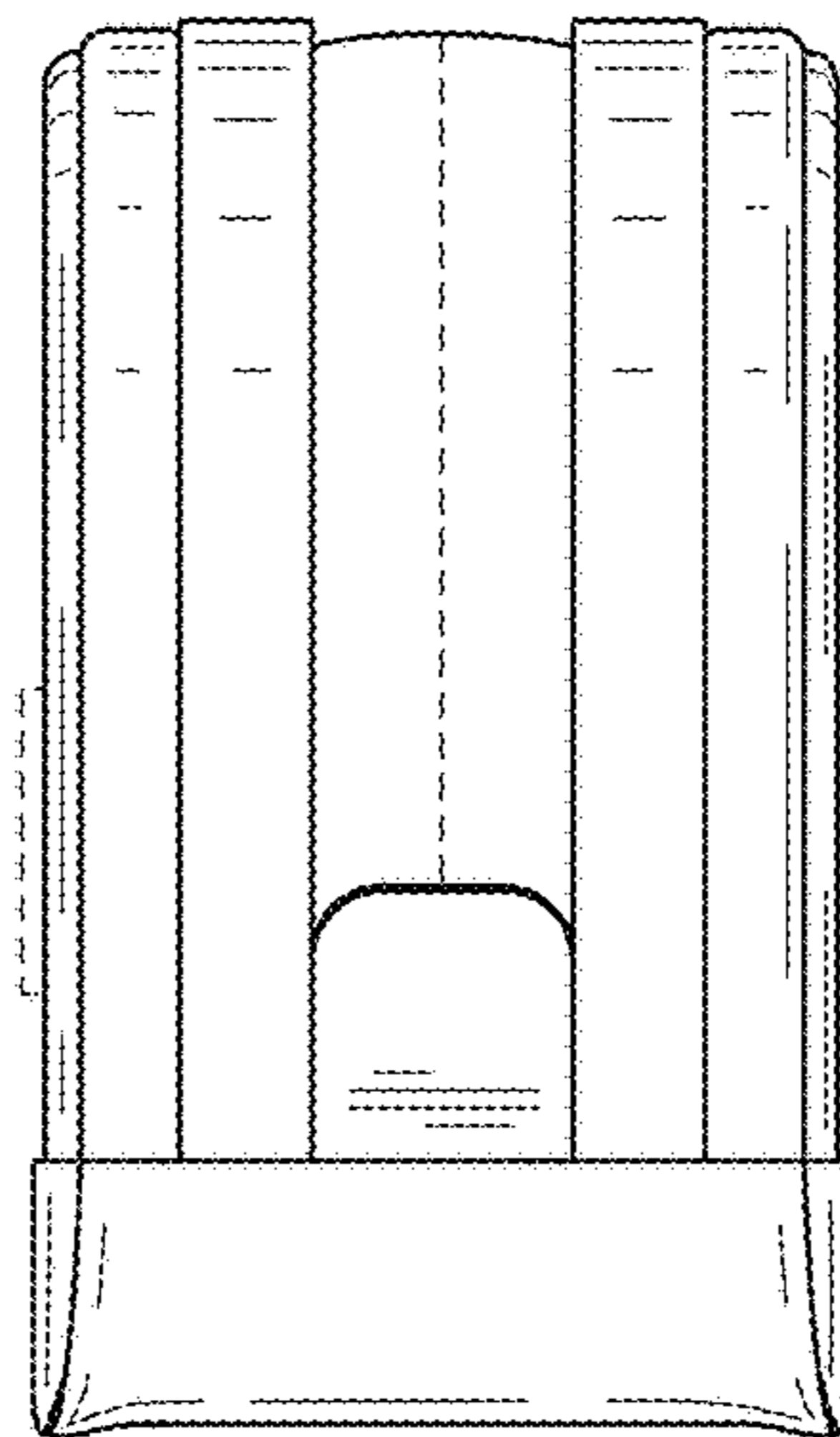

FIG. 5

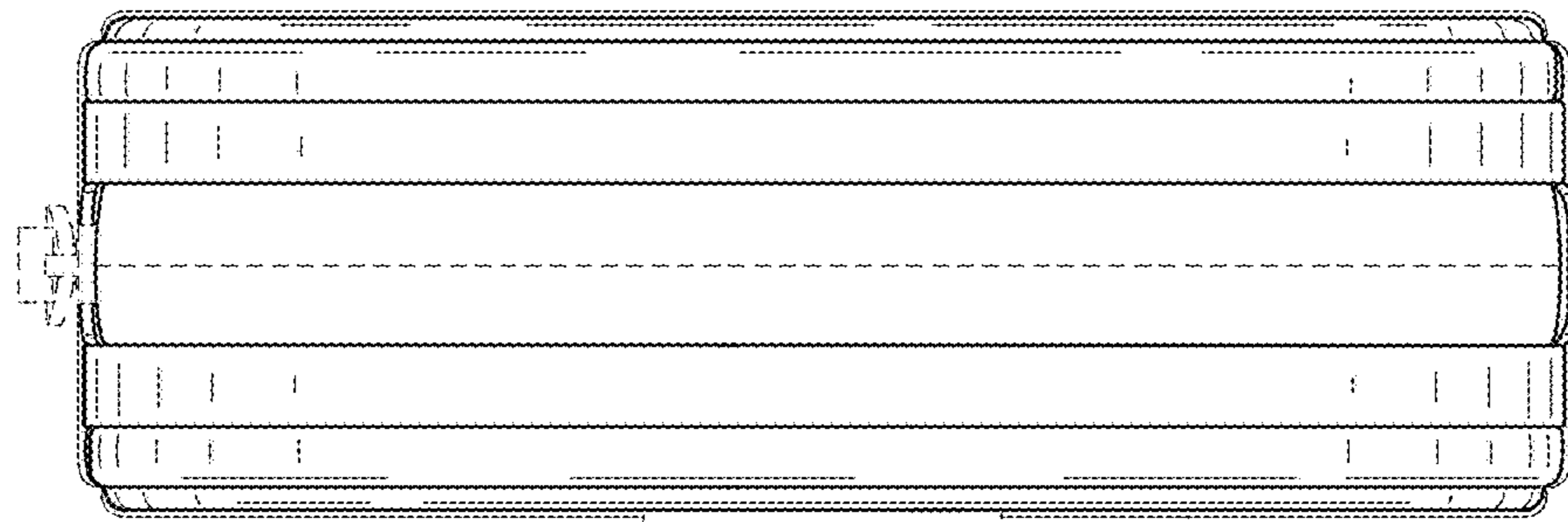

FIG. 6

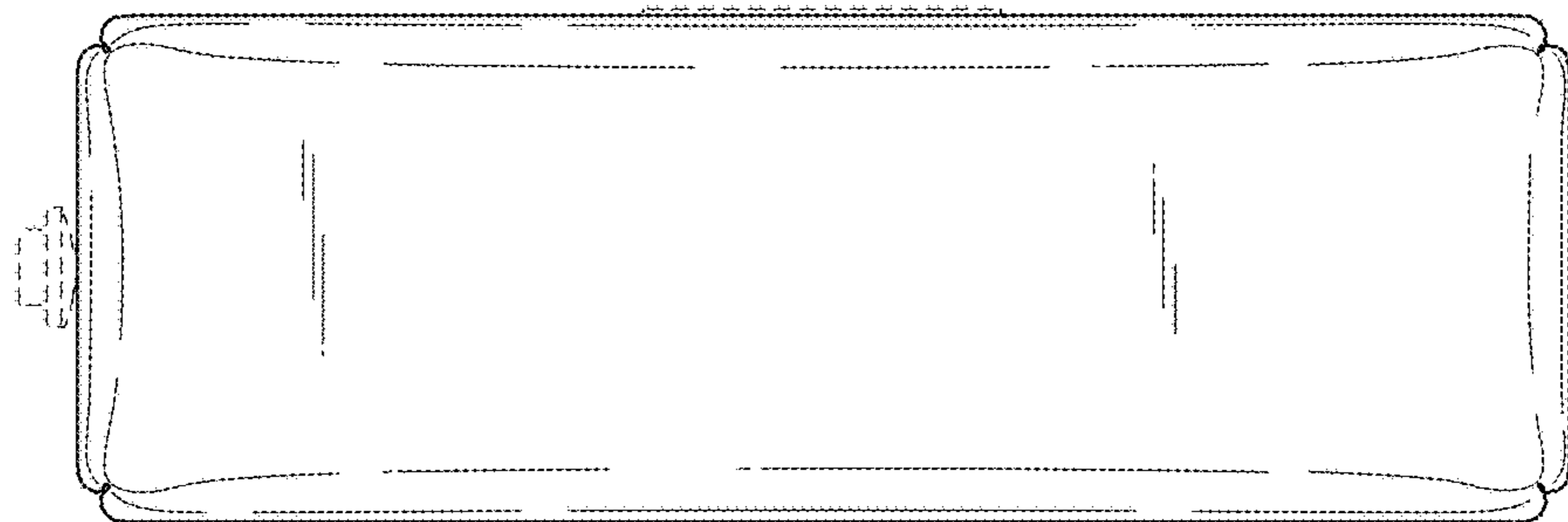

FIG. 7