



US00D840549S

(12) **United States Design Patent**
Kelly

(10) **Patent No.:** **US D840,549 S**
(45) **Date of Patent:** **** Feb. 12, 2019**

(54) **REAGENT RESERVOIR KIT**

DESCRIPTION

(71) Applicant: **Integra Biosciences AG**, Zizers (CH)
(72) Inventor: **Terrence Kelly**, Lowell, MA (US)
(73) Assignee: **Integra Biosciences AG**, Zizers (CH)
(**) Term: **15 Years**
(21) Appl. No.: **29/607,972**
(22) Filed: **Jun. 19, 2017**
(51) **LOC (11) Cl.** **24-02**
(52) **U.S. Cl.**
USPC **D24/223**
(58) **Field of Classification Search**
USPC D24/216, 224–227, 229, 231–233;
D3/203.1–203.8, 304, 313; D7/553.3;
D9/425, 431, 432, 456, 520, 732
(Continued)

FIG. 1 is a perspective view of a first embodiment of a reagent reservoir kit, showing the new design; FIG. 2 is a top view thereof; FIG. 3 is a left side elevation view thereof; FIG. 4 is a right side elevation view thereof; FIG. 5 is a front side elevation view thereof; FIG. 6 is a rear side elevation view thereof; FIG. 7 is a bottom plan view thereof; FIG. 8 is a perspective view of the reagent reservoir kit shown in FIGS. 1-7 with a lid removed to show a liner located in a base of the kit; FIG. 9 is a top plan view of the kit as shown in FIG. 8 with the lid removed; FIG. 10 is a left side elevation view of the kit shown in FIG. 8 with the lid removed; FIG. 11 is a right side elevation view of the kit shown in FIG. 8 with the lid removed; FIG. 12 is a front side elevation view of the kit shown in FIG. 8 with the lid removed; FIG. 13 is a rear side elevation view of the kit shown in FIG. 8 with the lid removed; FIG. 14 is a bottom plan view of the kit shown in FIG. 8 with the lid removed; FIG. 15 is a perspective view of the base for the reservoir reagent kit of the first and second embodiments; FIG. 16 is a top plan view of the base illustrated in FIG. 15; FIG. 17 is a left side elevation view of the base shown in FIG. 15; FIG. 18 is a right side elevation view of the base shown in FIG. 15; FIG. 19 is a front side elevation view of the base shown in FIG. 15; FIG. 20 is a rear side elevation view of the base shown in FIG. 15; FIG. 21 is a bottom plan view of the base shown in FIG. 15; FIG. 22 is a perspective view of a third embodiment of a reagent reservoir kit, showing the new design; FIG. 23 is a top view thereof; FIG. 24 is a left side elevation view thereof; FIG. 25 is a right side elevation view thereof; FIG. 26 is a front side elevation view thereof;

(56) **References Cited**

U.S. PATENT DOCUMENTS

3,819,505 A * 6/1974 Parent G01N 27/44756
422/430
4,721,679 A * 1/1988 Yiu B01L 3/5085
220/23.8

(Continued)

OTHER PUBLICATIONS

VistaLab Technologies Reagent Reservoirs, <https://vistalabl.com/>
Reagent Reservoirs, website visited Jun. 26, 2017.

Primary Examiner — Ian Simmons
Assistant Examiner — Samantha Q. Lawrence
(74) *Attorney, Agent, or Firm* — Andrus Intellectual
Property Law

(57) **CLAIM**

I claim an ornamental design for a reagent reservoir kit, as shown and described.

(Continued)

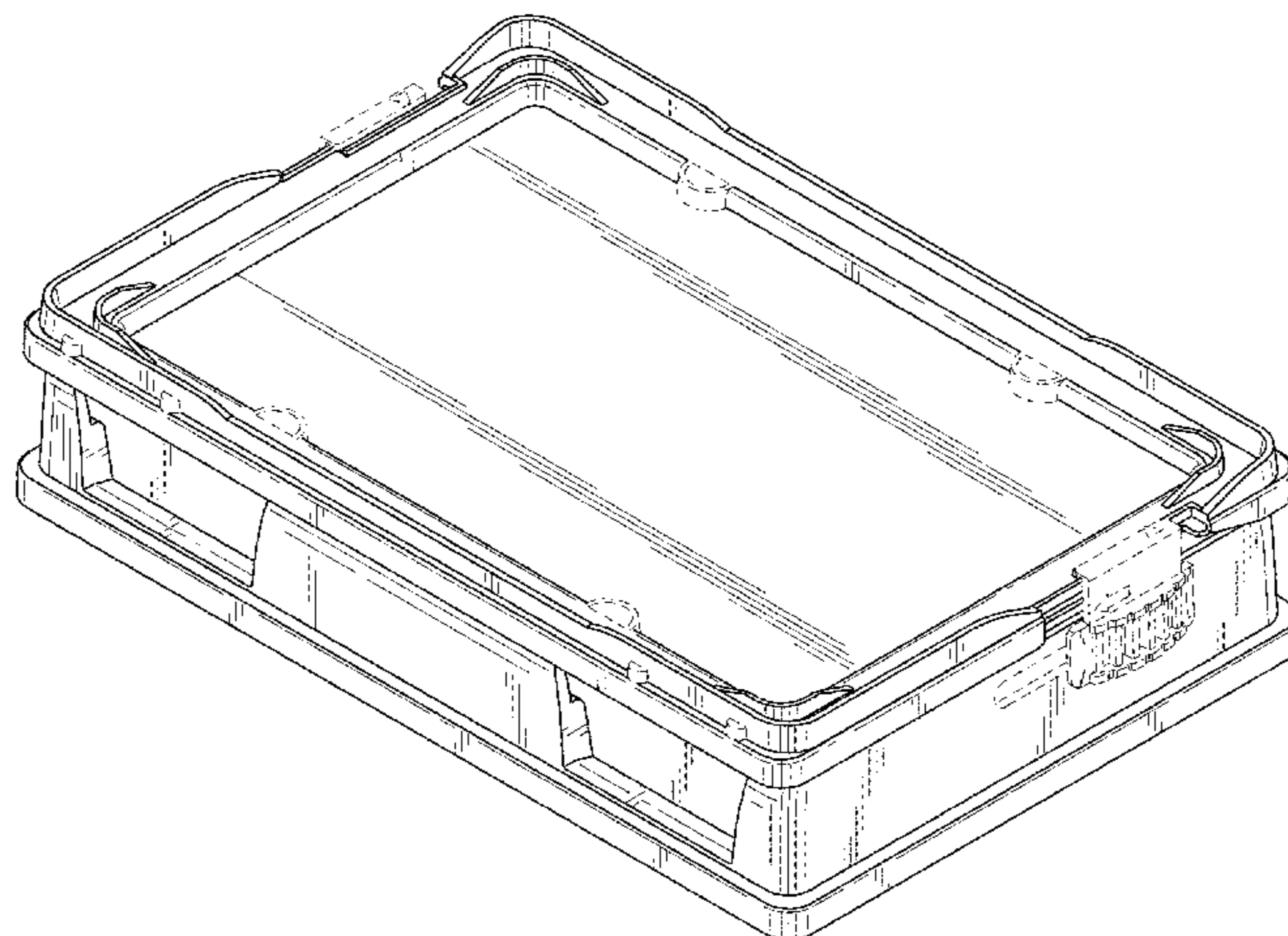

FIG. 27 is a rear side elevation view thereof;
 FIG. 28 is a bottom plan view thereof;
 FIG. 29 is a perspective view of the reagent reservoir kit shown in FIGS. 24-28 with a lid removed to show a liner located in a base of the kit;
 FIG. 30 is a top plan view of the kit as shown in FIG. 29 with the lid removed;
 FIG. 31 is a left side elevation view of the kit shown in FIG. 29 with the lid removed;
 FIG. 32 is a right side elevation view of the kit shown in FIG. 29 with the lid removed;
 FIG. 33 is a front side elevation view of the kit shown in FIG. 29 with the lid removed;
 FIG. 34 is a rear side elevation view of the kit shown in FIG. 29 with the lid removed;
 FIG. 35 is a bottom plan view of the kit shown in FIG. 29 with the lid removed;
 FIG. 36 is a perspective view of the base for the reservoir reagent kit of the third and fourth embodiments;
 FIG. 37 is a top plan view of the base illustrated in FIG. 36;
 FIG. 38 is a left side elevation view of the base shown in FIG. 36;
 FIG. 39 is a right side elevation view of the base shown in FIG. 36;
 FIG. 40 is a front side elevation view of the base shown in FIG. 36;
 FIG. 41 is a rear side elevation view of the base shown in FIG. 36; and,
 FIG. 42 is a bottom plan view of the base shown in FIG. 36.
 The broken lines in the drawings are included for the purpose of illustrating portions of the kit that form no part of the claimed design.

1 Claim, 30 Drawing Sheets

(58) **Field of Classification Search**

CPC . A61L 2/00; A61L 2/0011; A61L 2/06; A61L 2/10; A61L 2/26; A61M 1/3693; A61M 25/002; B01F 11/0022; B01F 11/0266; B01J 19/0046; B01L 3/0275; B01L 3/50; B01L 3/52; B01L 3/502; B01L 3/5021; B01L 3/5025; B01L 3/502715; B01L 3/505; B01L 3/508; B01L 3/5023; B01L 3/50255; B01L 3/502761; B01L 3/502707; B01L 3/5082; B01L 3/50825; B01L 3/5085; B01L 3/50851; B01L 3/50855; B01L 3/50853; B01L 3/523;

B01L 3/527; B01L 3/545; B01L 7/00; B01L 7/52; B01L 9/06; B01L 9/52; B05C 3/109; B65D 81/3484; G01N 21/03; G01N 21/07; G01N 27/00; G01N 27/44756; G01N 27/447; G01N 27/44704; G01N 27/4473; G01N 27/4475; G01N 27/61; G01N 27/84; G01N 33/08524; G01N 33/383; G01N 33/5032; G01N 33/54326; G01N 33/543; G01N 33/5431; G01N 33/5436; G01N 33/558; G01N 35/00029; G01N 35/02; G01N 35/025; G01N 35/026; G01N 35/04; G01N 35/1002; G03C 8/34
 See application file for complete search history.

(56)

References Cited

U.S. PATENT DOCUMENTS

4,822,742	A *	4/1989	Challberg	B01L 3/508 422/940
4,830,725	A *	5/1989	Berninger	G01N 27/44704 204/620
D303,012	S *	8/1989	Flesher	D24/233
D315,951	S *	4/1991	Berninger	D24/233
5,013,420	A *	5/1991	Schuette	G01N 27/4473 204/614
5,085,758	A *	2/1992	Guadagno	G01N 27/44704 204/616
5,514,255	A *	5/1996	Gautsch	G01N 27/44704 204/466
5,641,065	A	6/1997	Owens et al.	
6,027,695	A	2/2000	Oldenburg et al.	
6,036,021	A *	3/2000	Moi	G01N 27/44704 204/456
6,800,491	B2	10/2004	Ringleben et al.	
7,118,713	B2 *	10/2006	Brock	B01L 9/52 422/566
7,217,397	B1 *	5/2007	Astle	B01L 3/50855 117/206
D559,398	S	1/2008	Maliakal	
D587,110	S	2/2009	Kronshage et al.	
D599,031	S	8/2009	Kelly	
7,811,522	B2	10/2010	Mathus et al.	
D629,119	S *	12/2010	Motadel	D24/224
D669,596	S	10/2012	Motadel	
2011/0177592	A1 *	7/2011	Faustman	B03C 1/288 435/325
2013/0017132	A1 *	1/2013	Schryver	B01L 3/508 422/547
2017/0028400	A1 *	2/2017	Gaynor	B01L 3/52
2017/0045542	A1 *	2/2017	Lapham	G01N 35/026
2017/0157611	A1 *	6/2017	Weber	B01L 3/502707
2017/0246630	A1 *	8/2017	Gaynor	B01L 3/50851

* cited by examiner

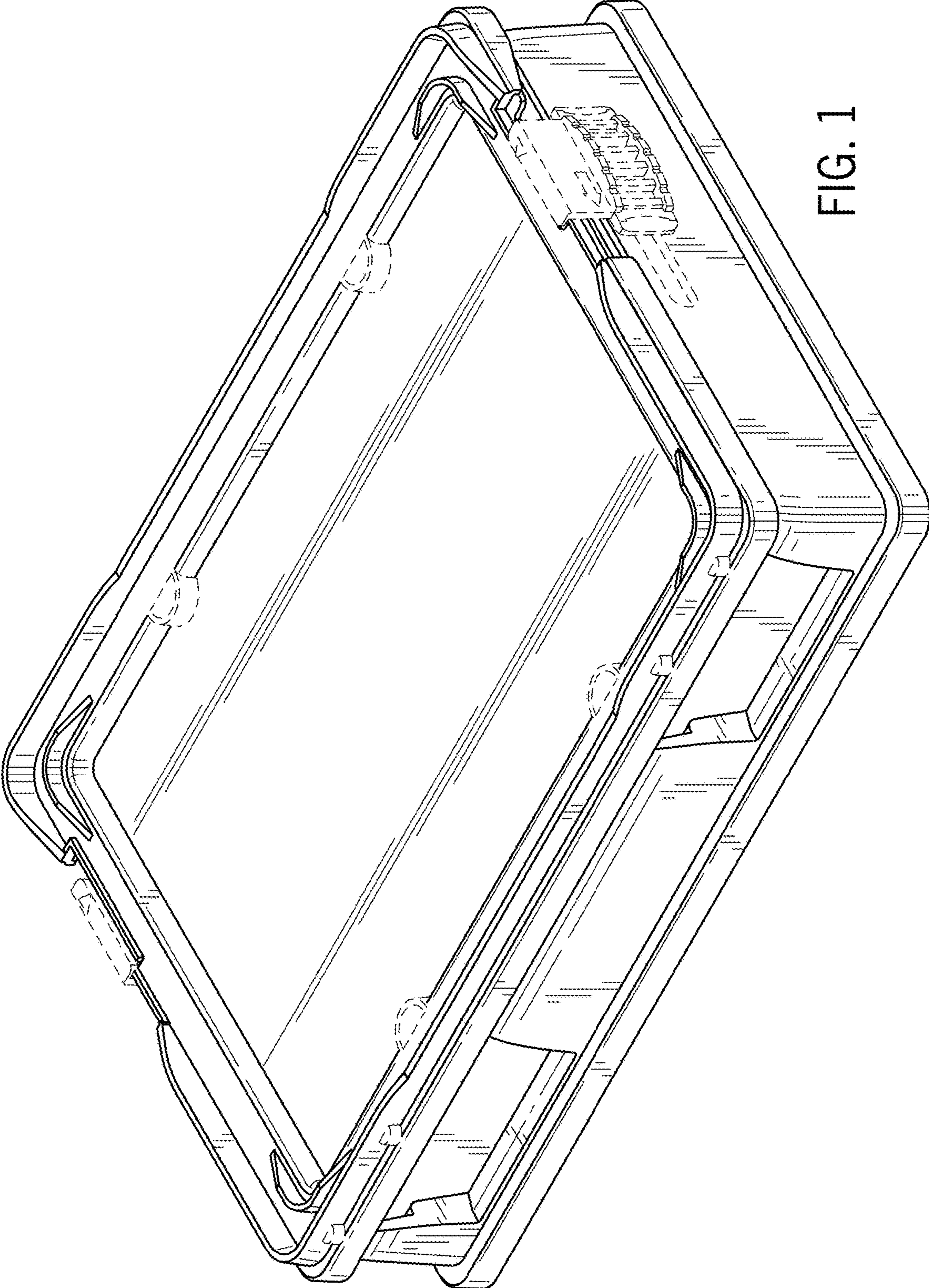
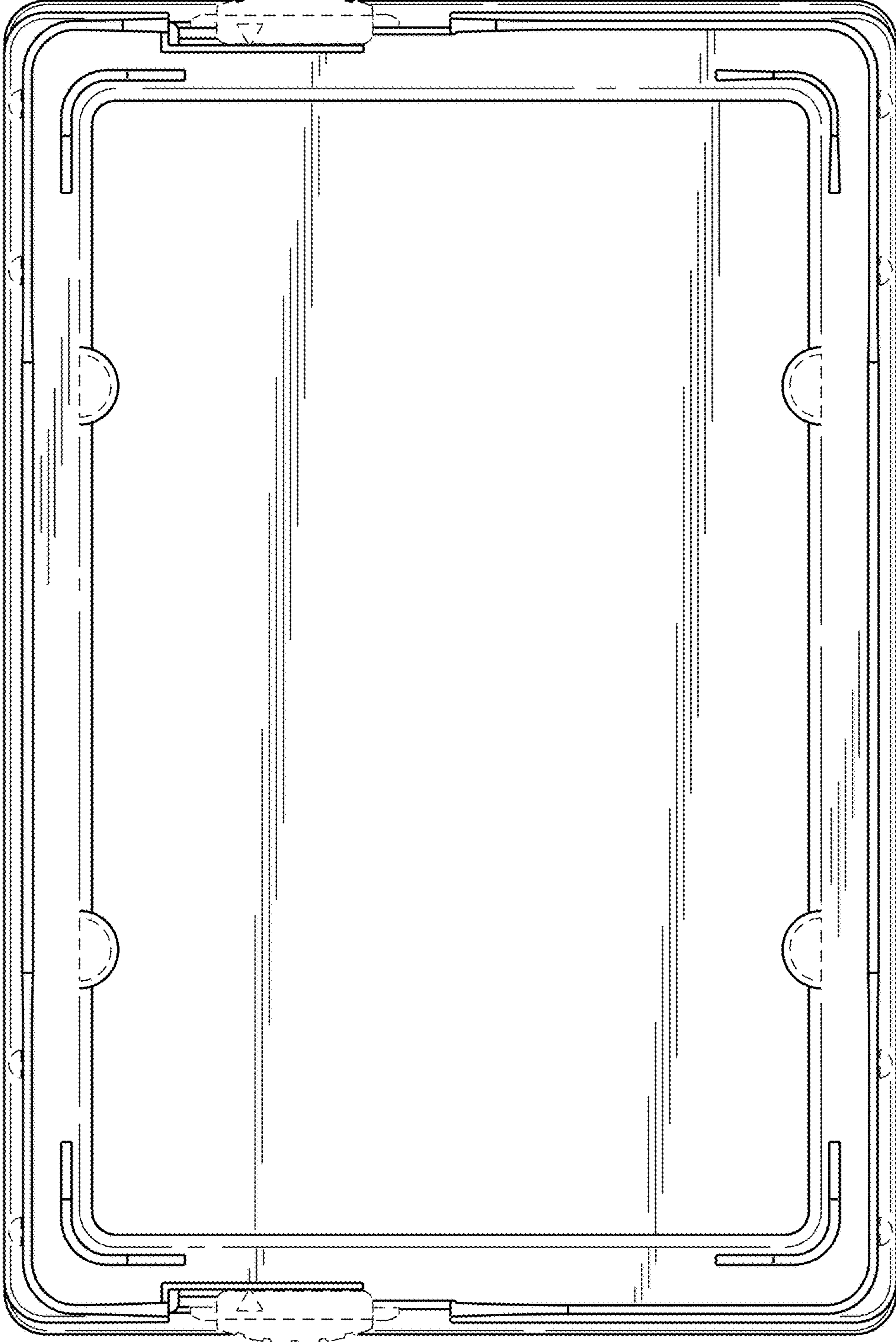

FIG. 1

FIG. 2



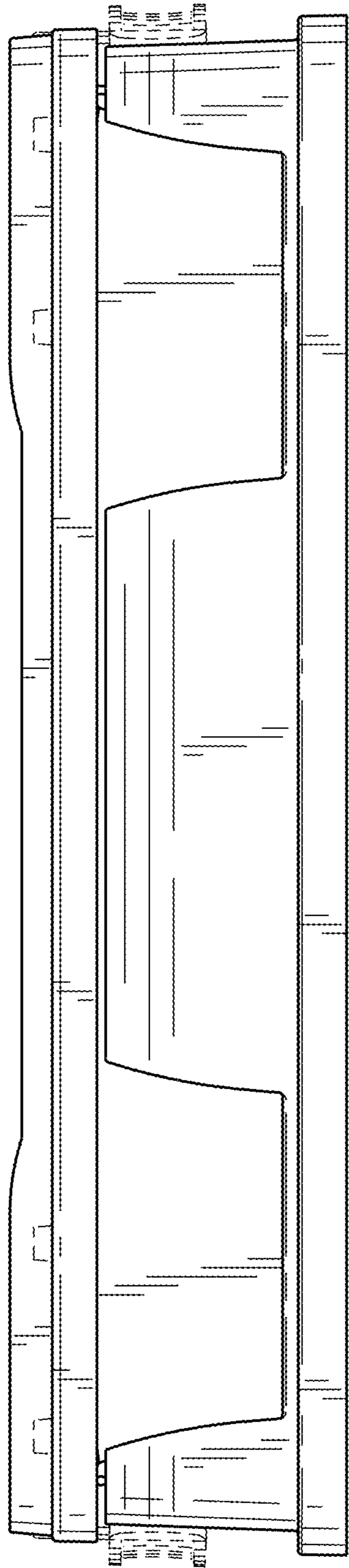

FIG. 3

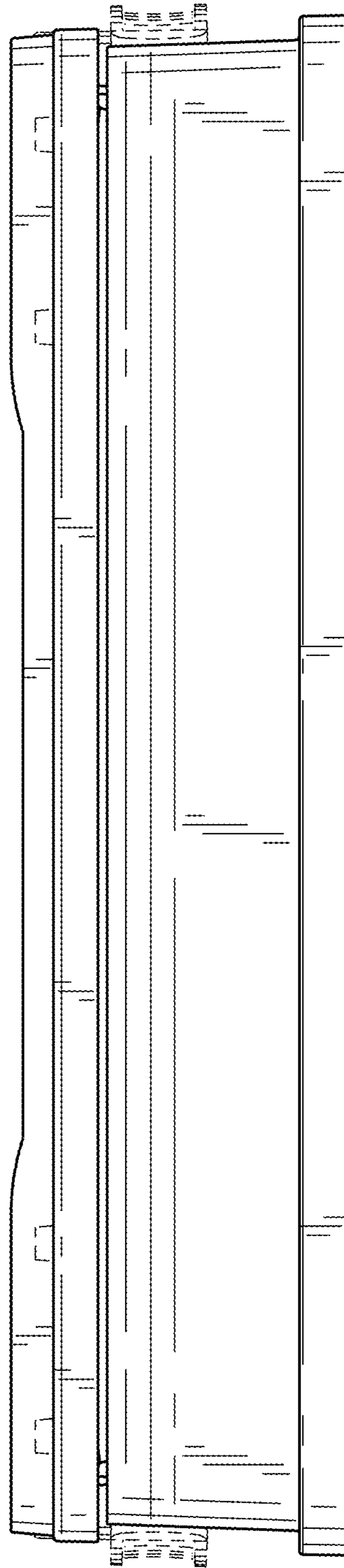

FIG. 4

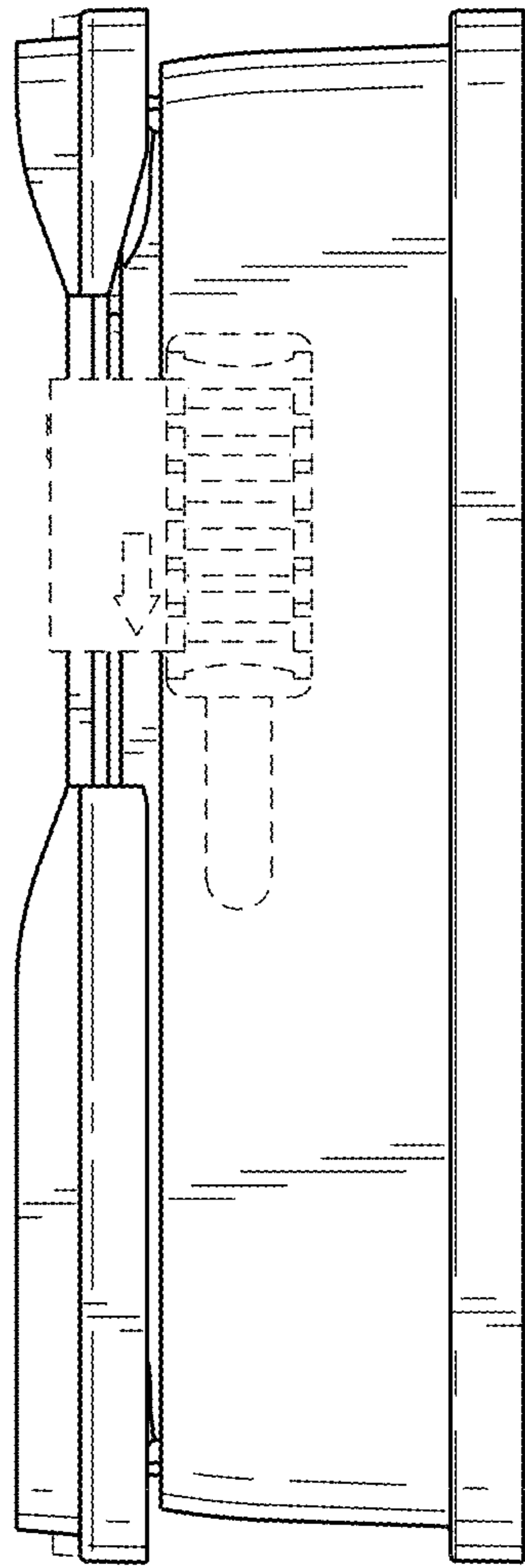

FIG. 5

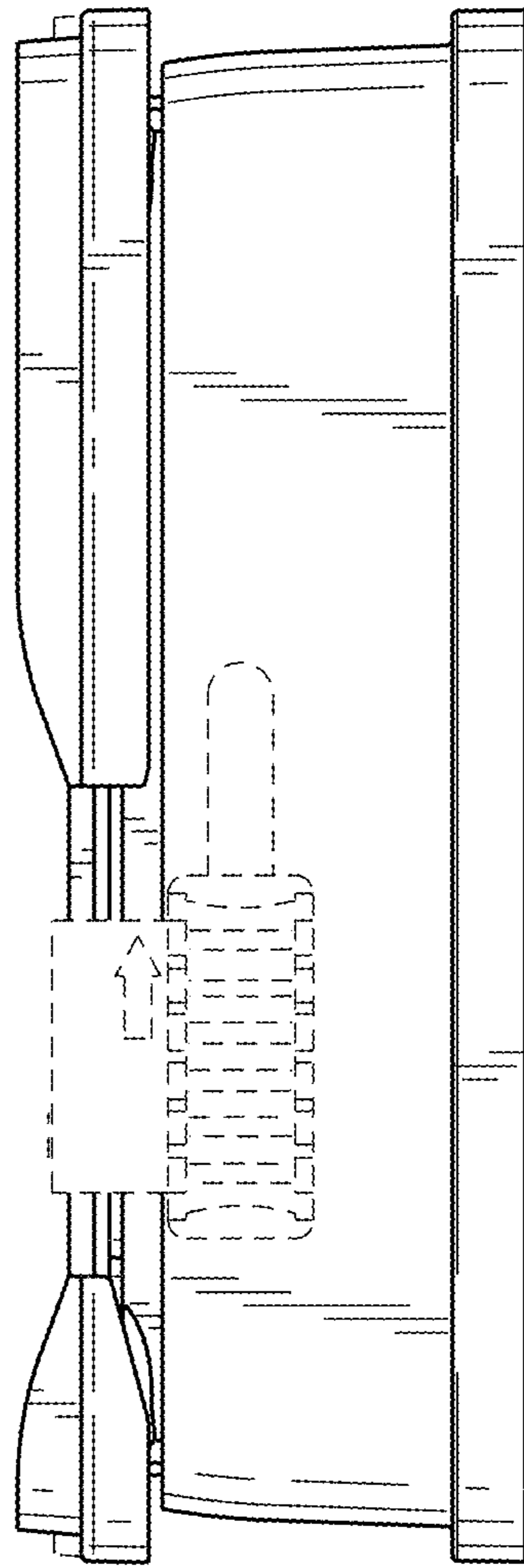

FIG. 6

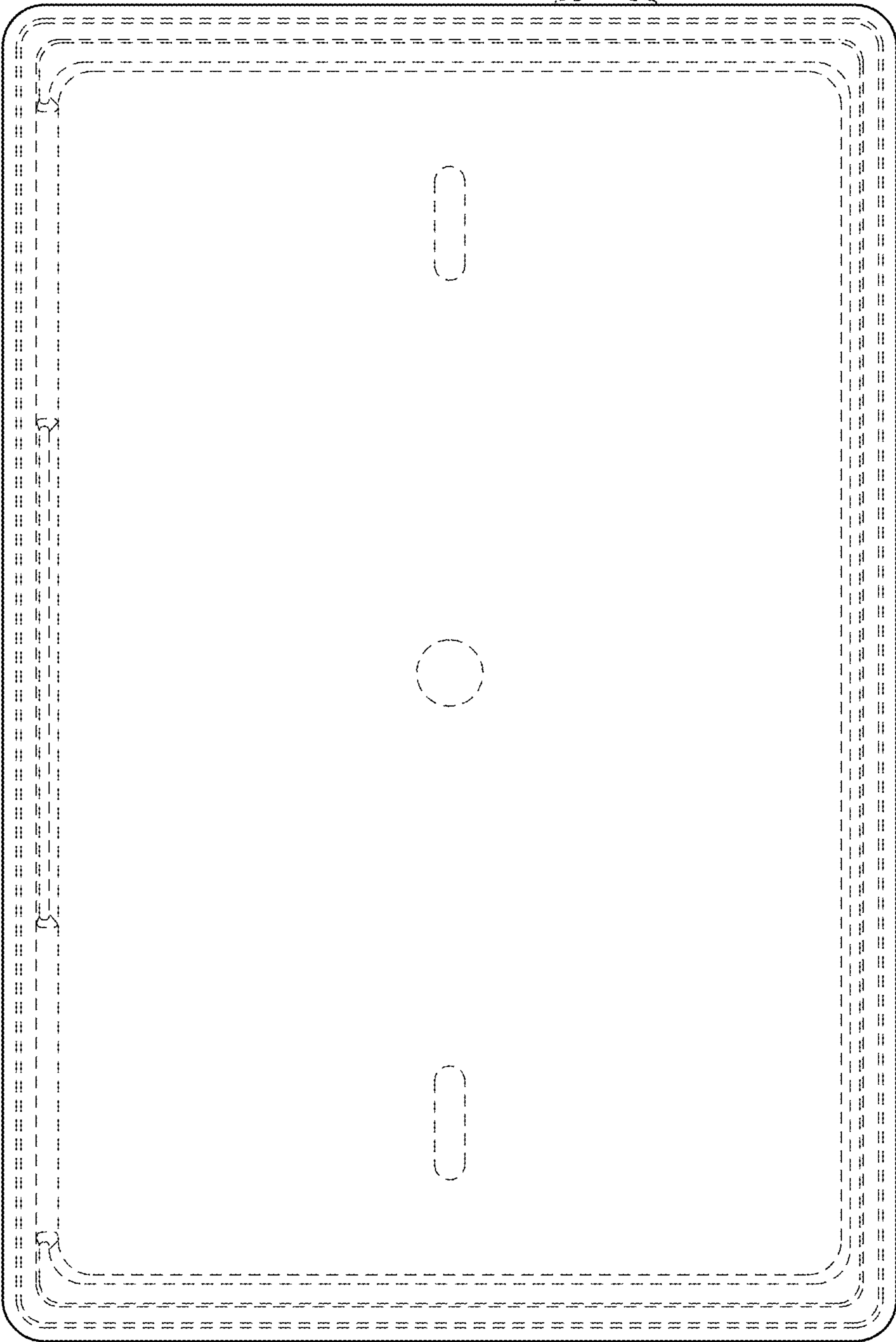

FIG. 7

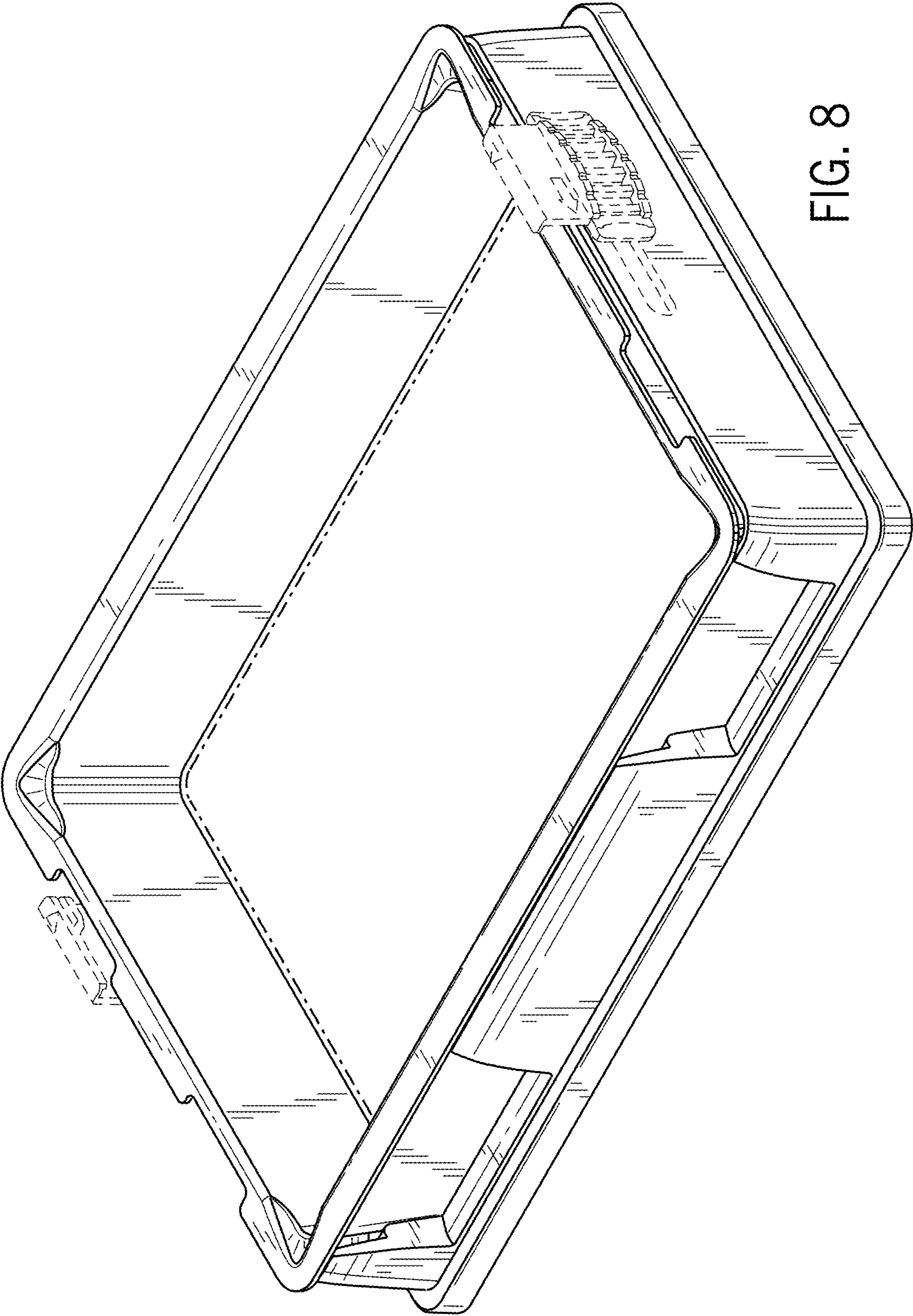
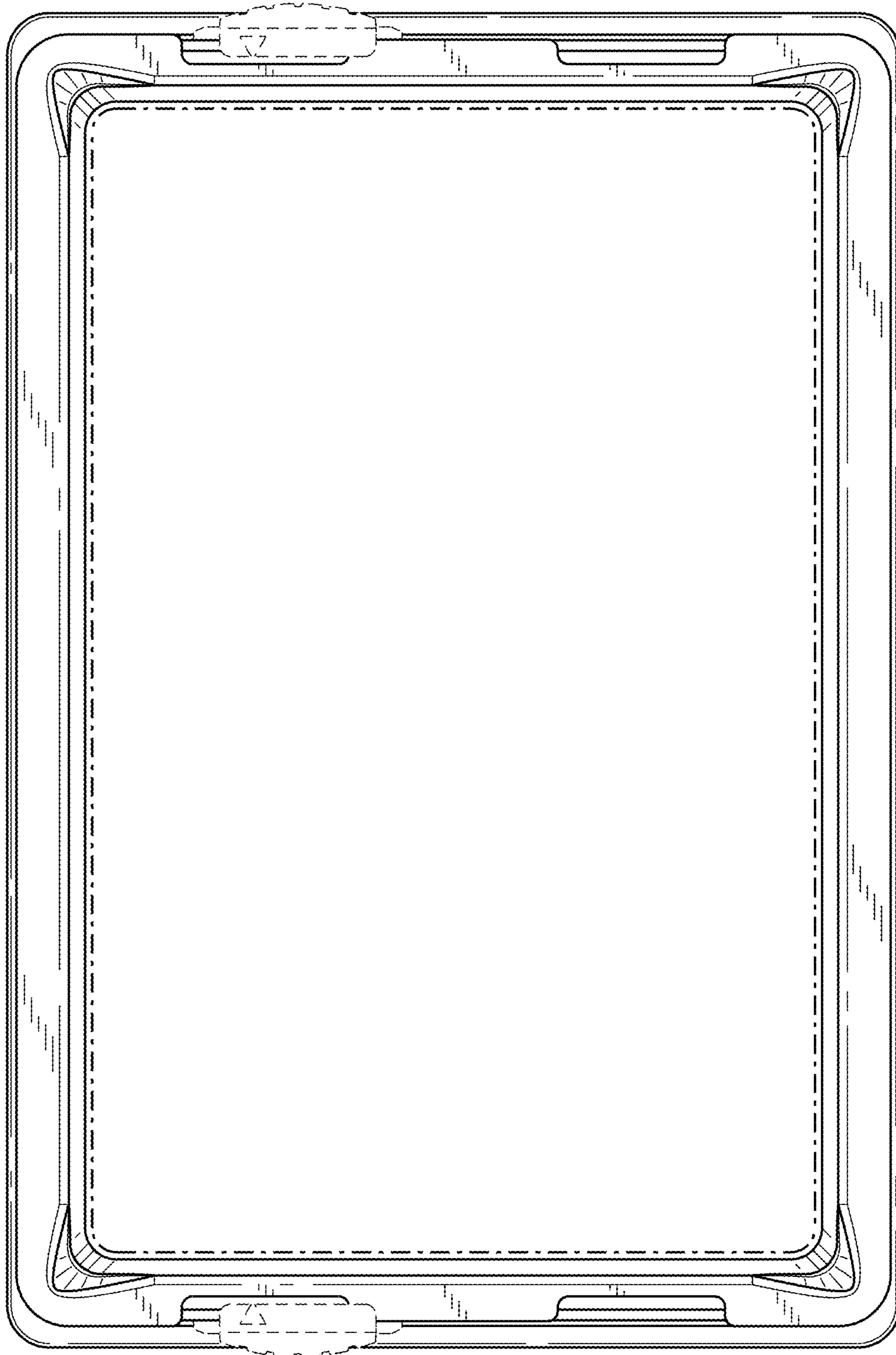

FIG. 8

FIG. 9



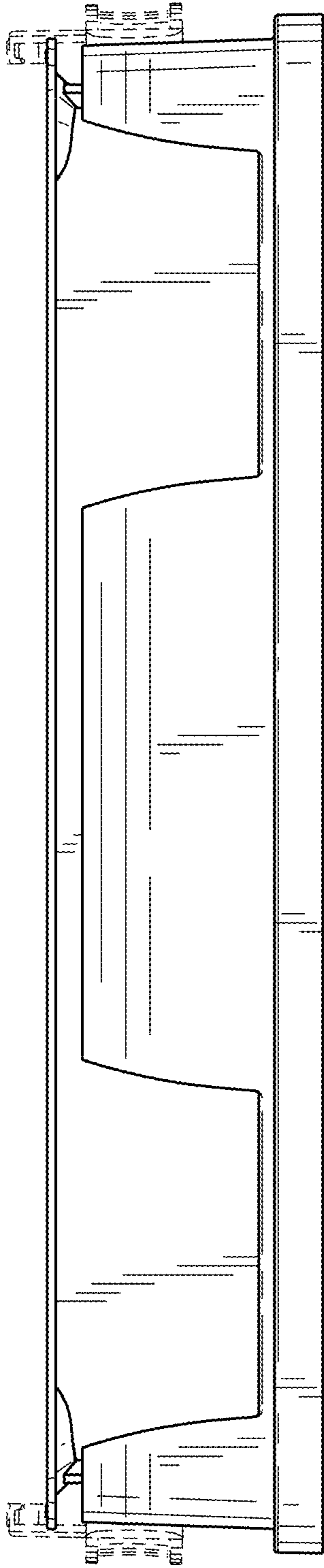

FIG. 10

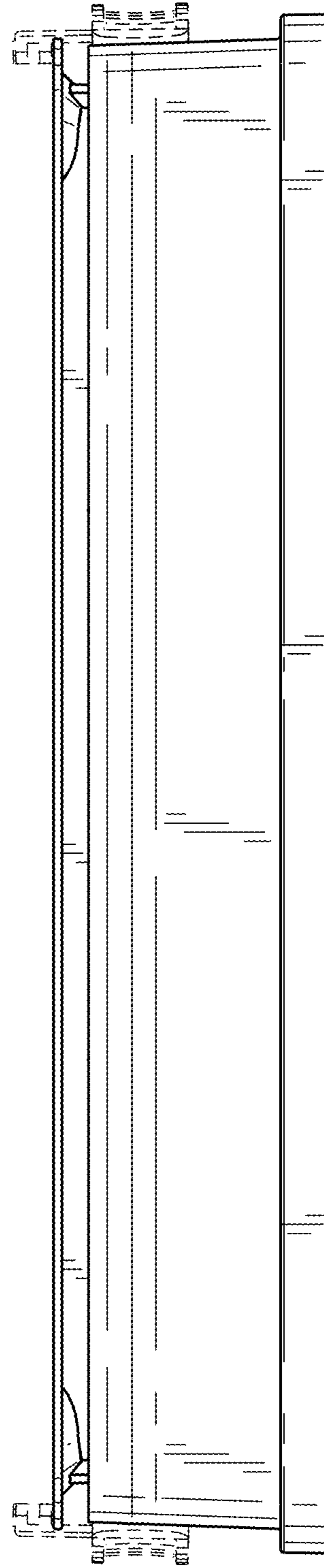

FIG. 11

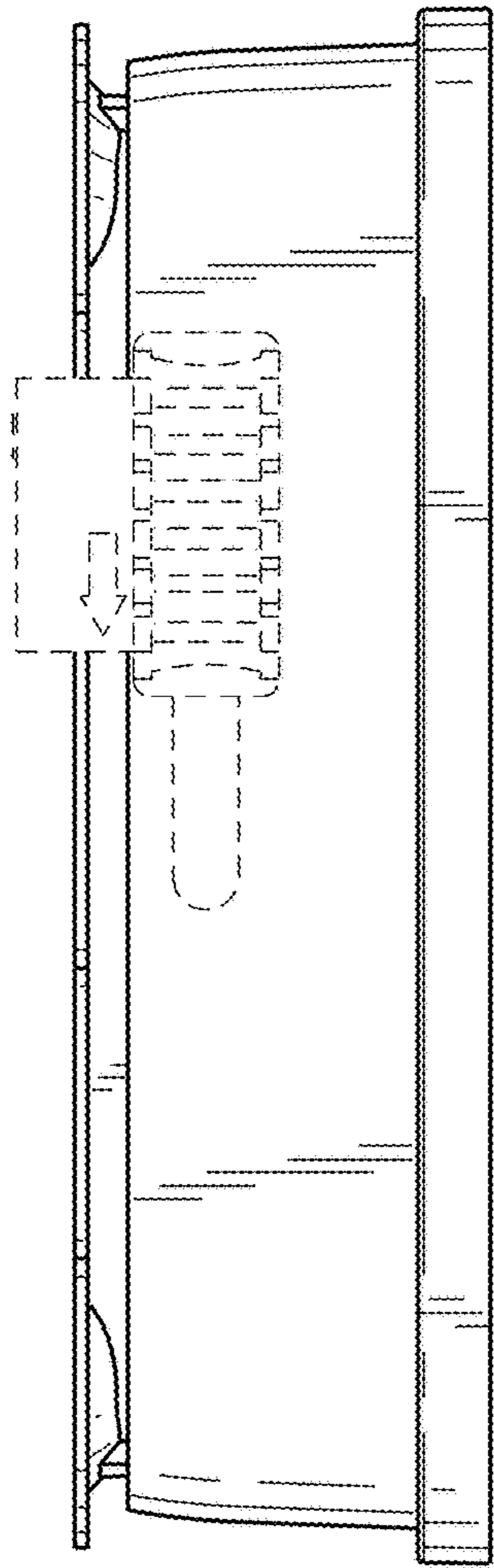

FIG. 12

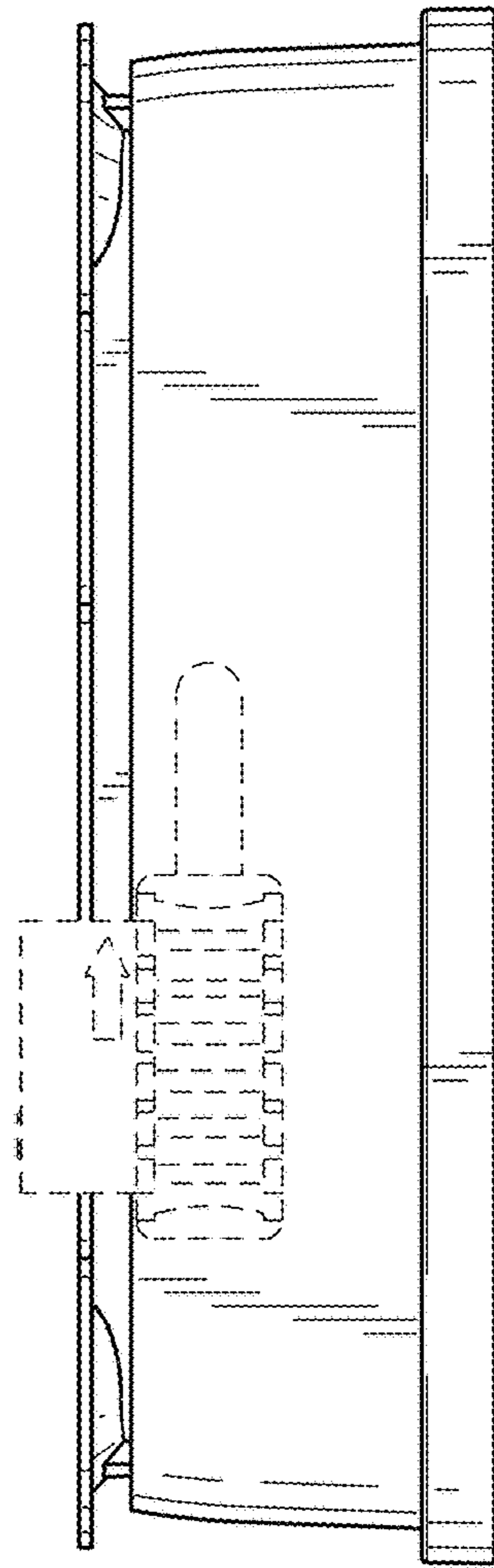

FIG. 13

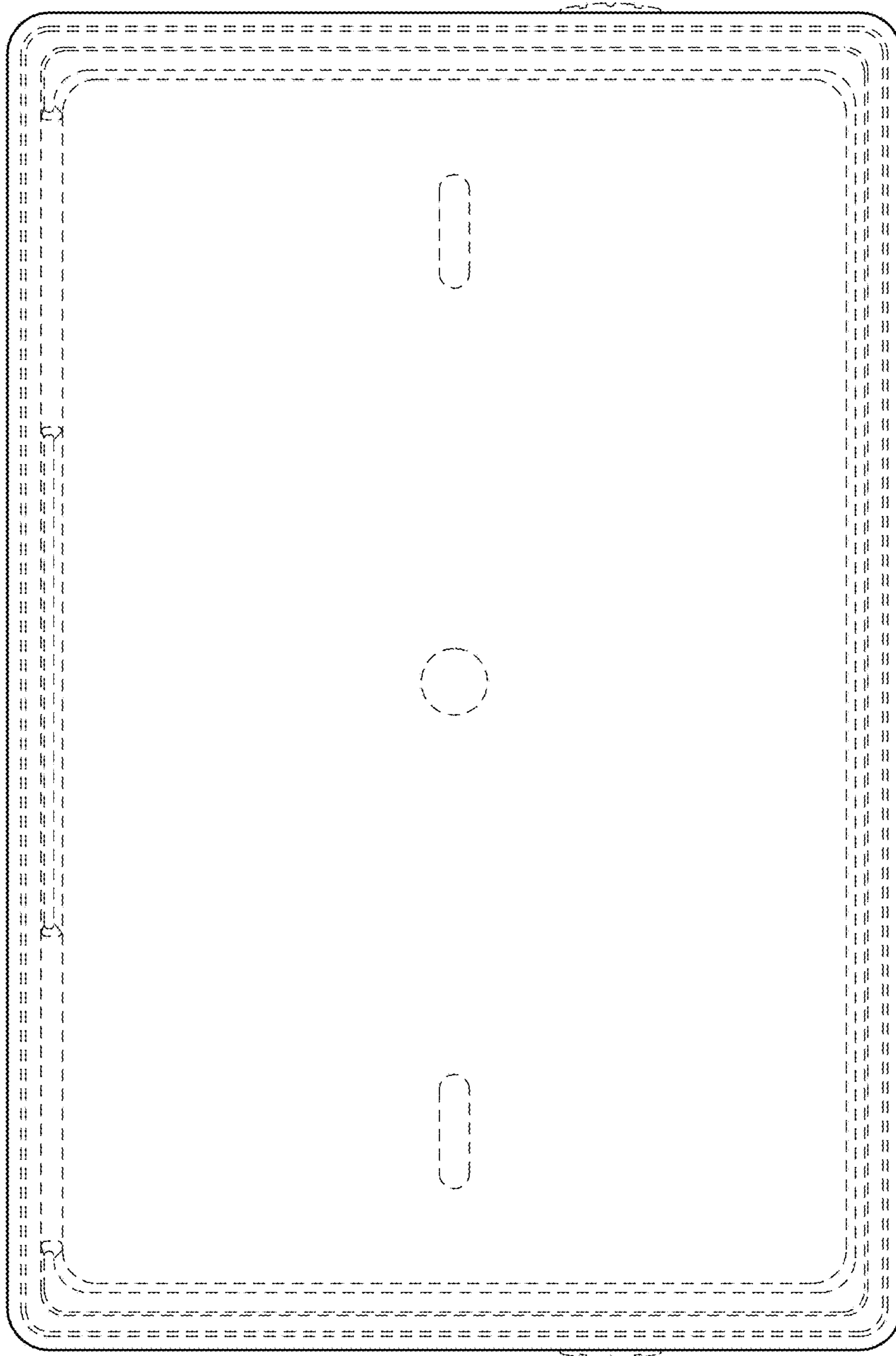

FIG. 14

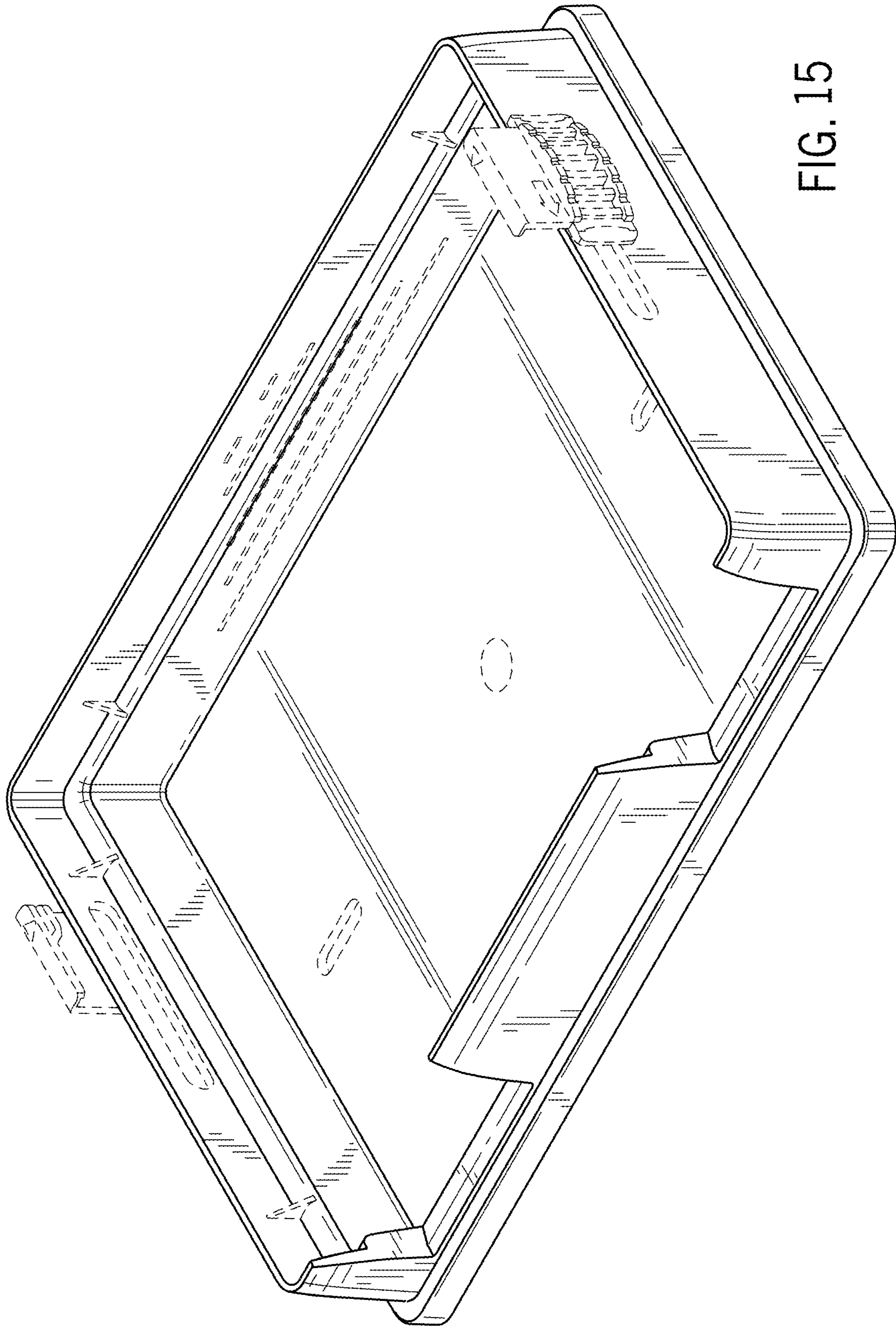
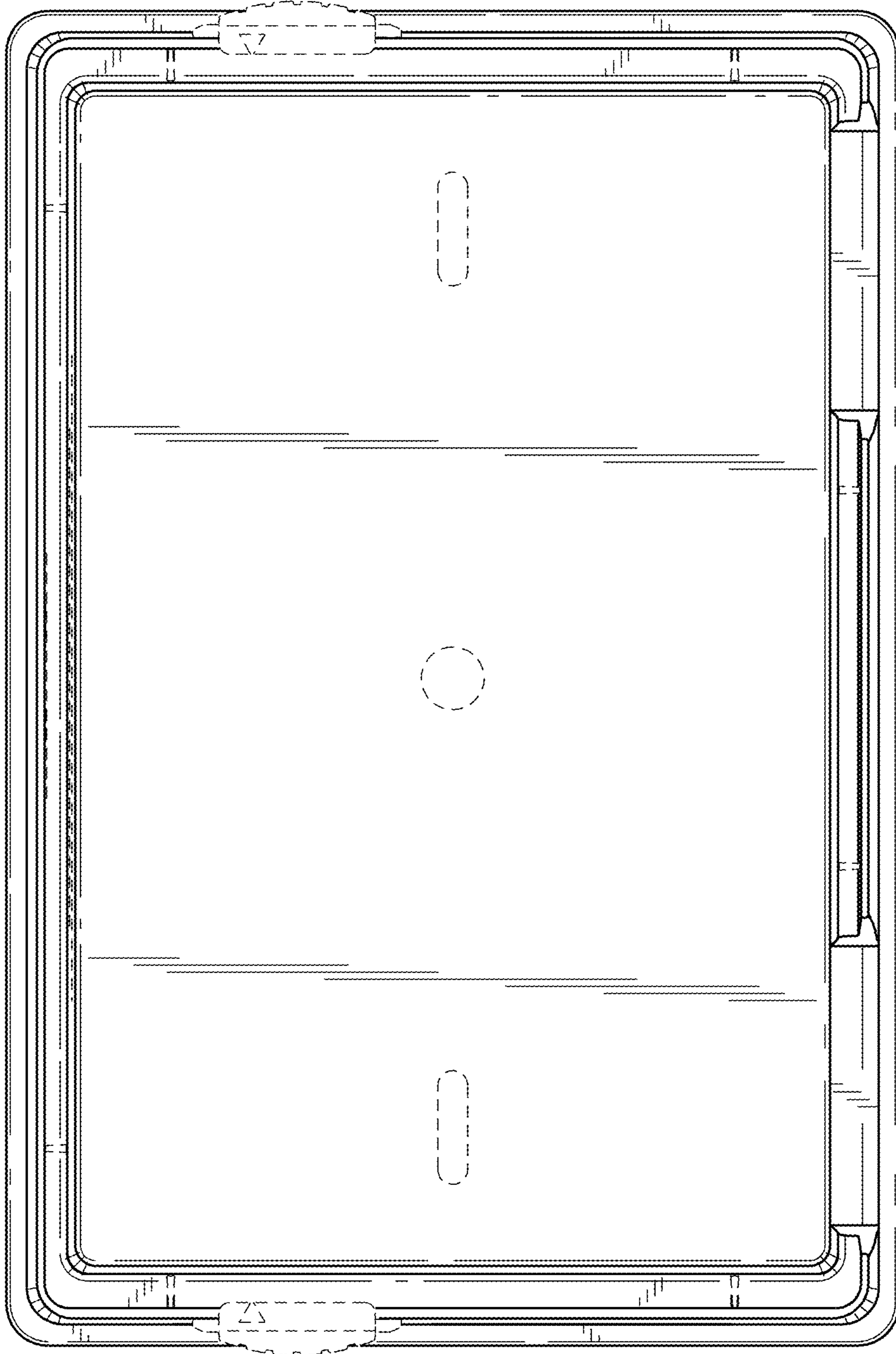

FIG. 15

FIG. 16



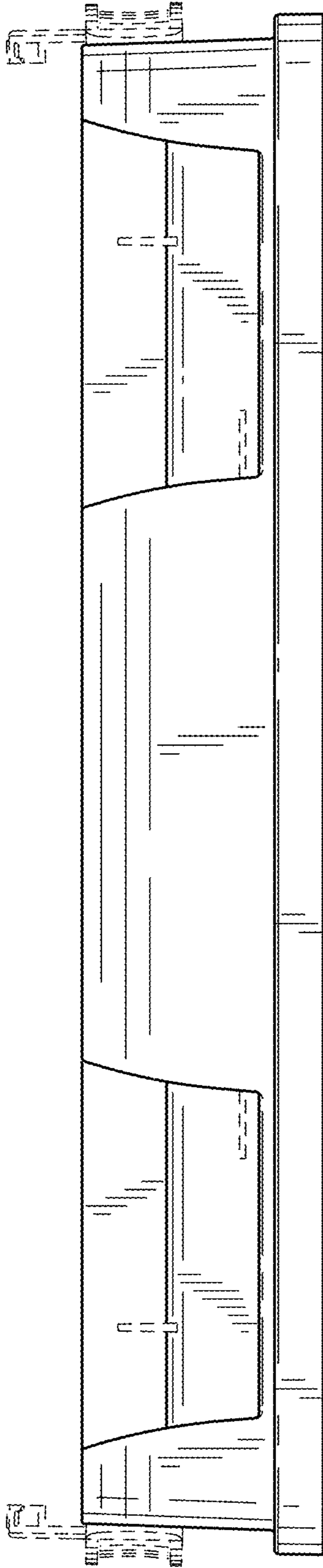

FIG. 17

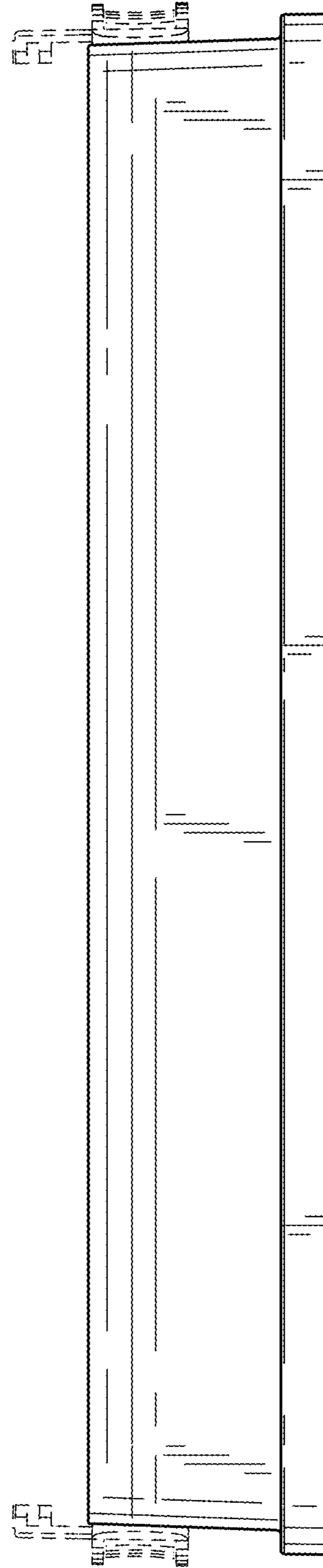

FIG. 18

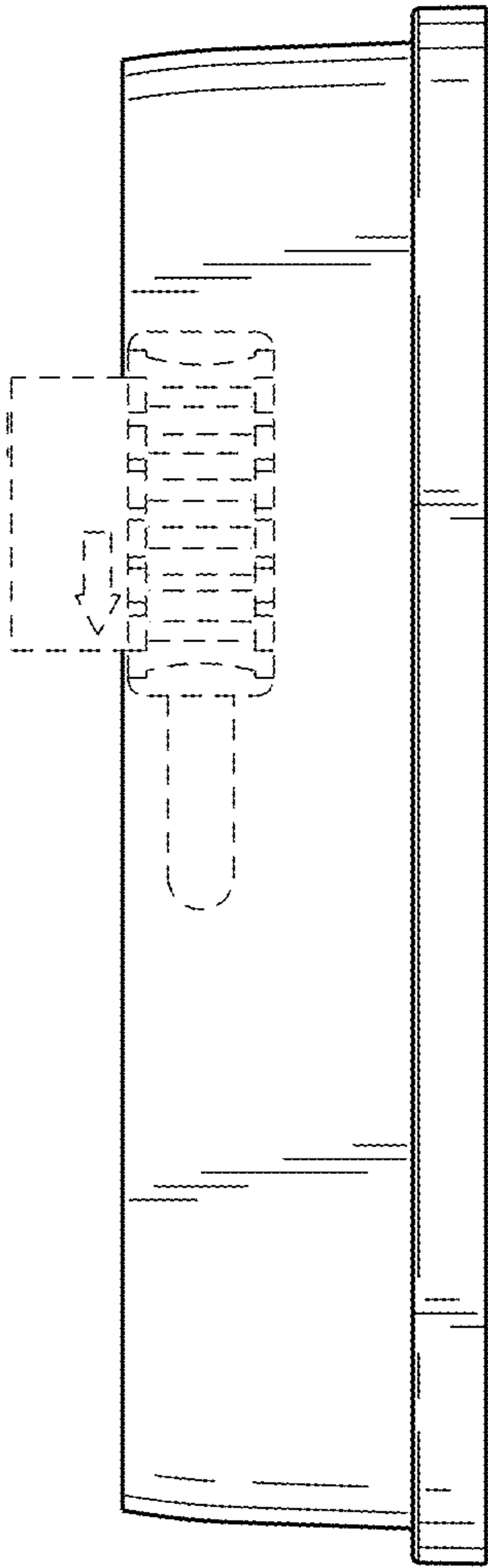

FIG. 19

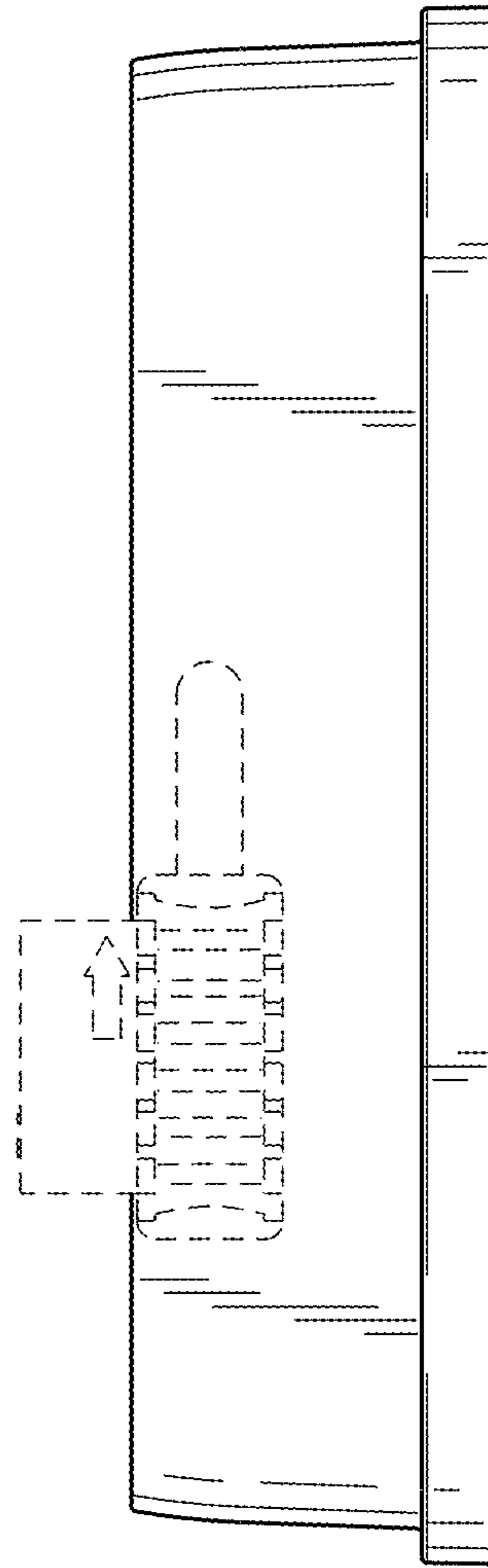

FIG. 20

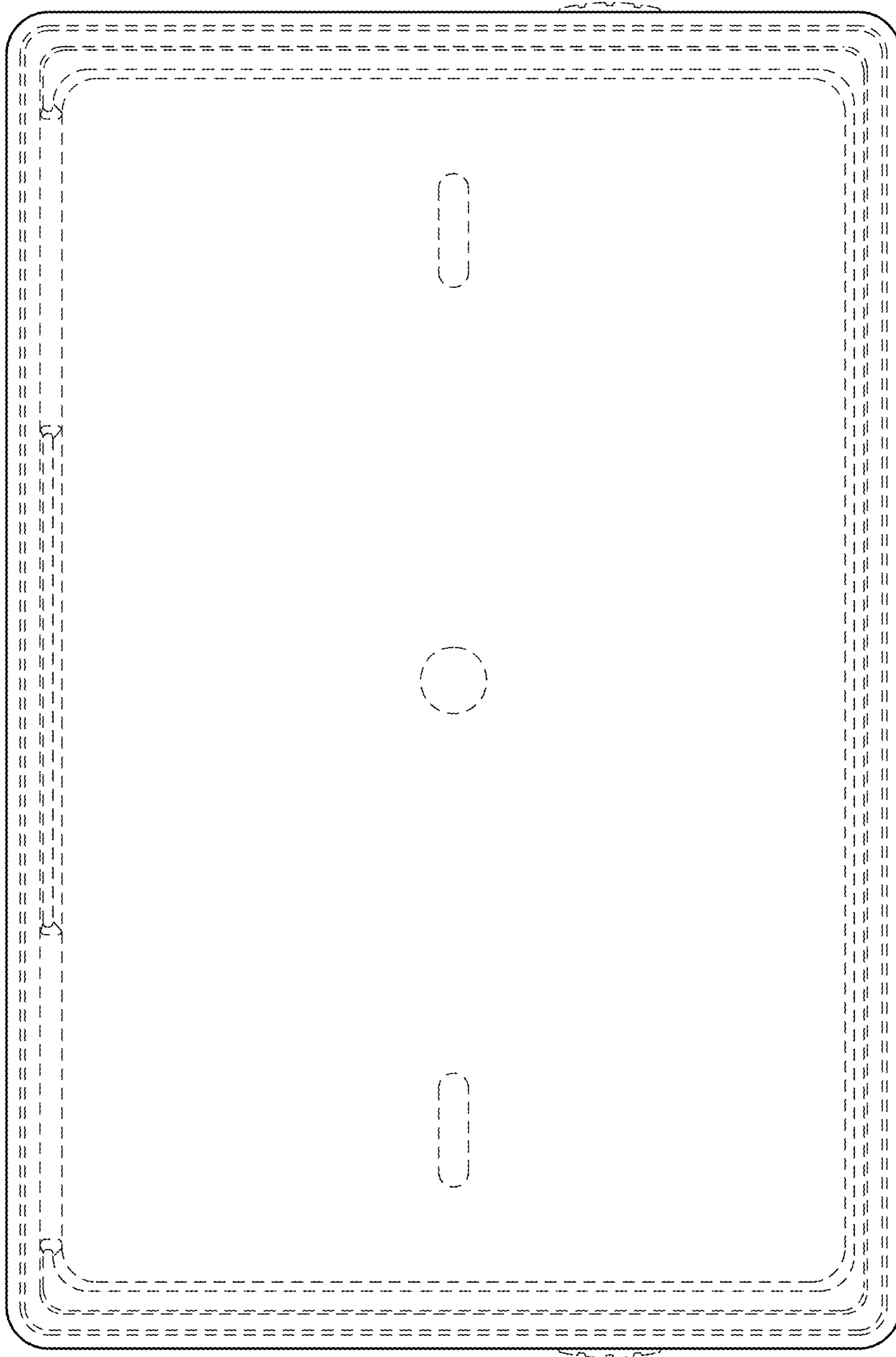

FIG. 21

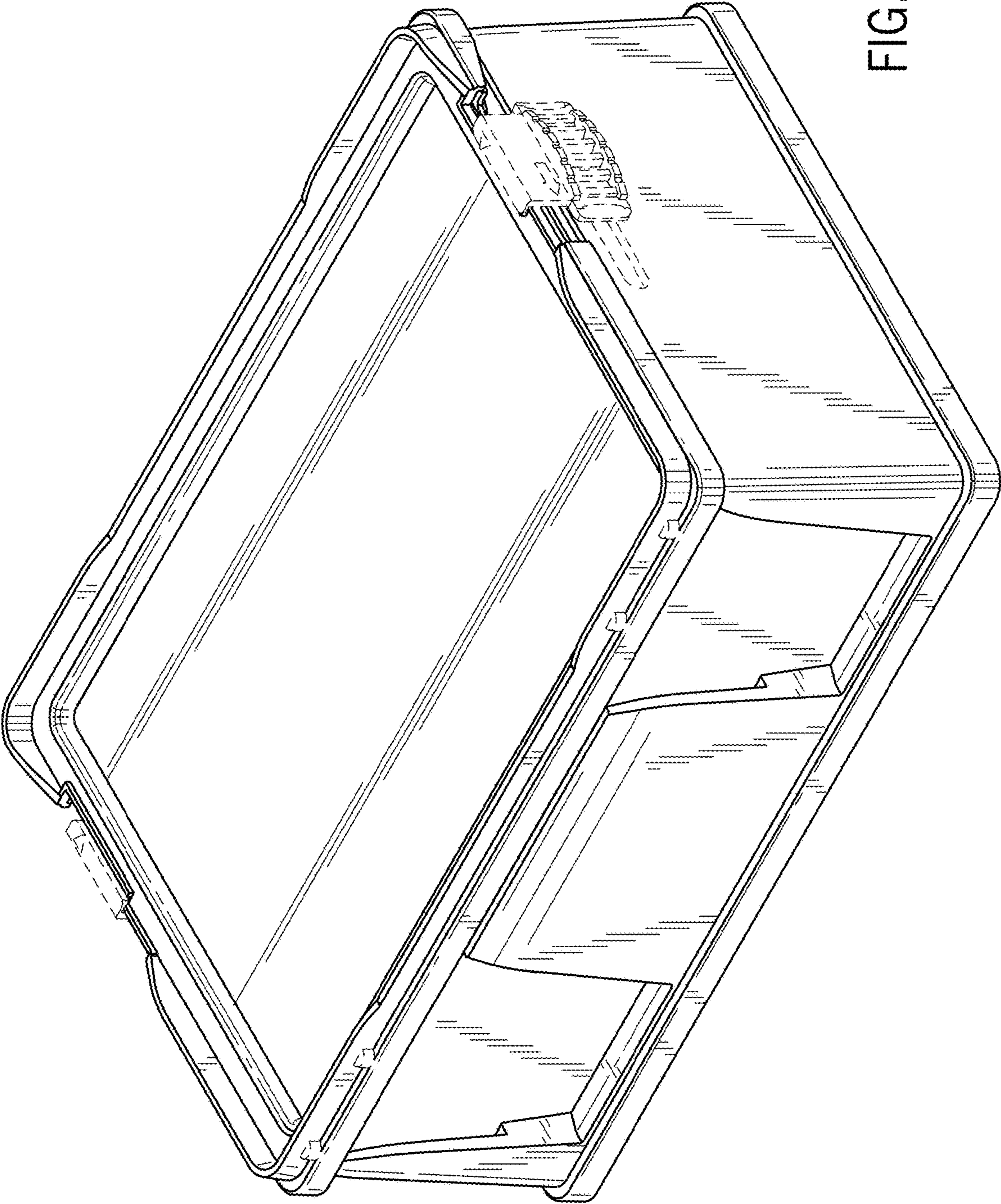
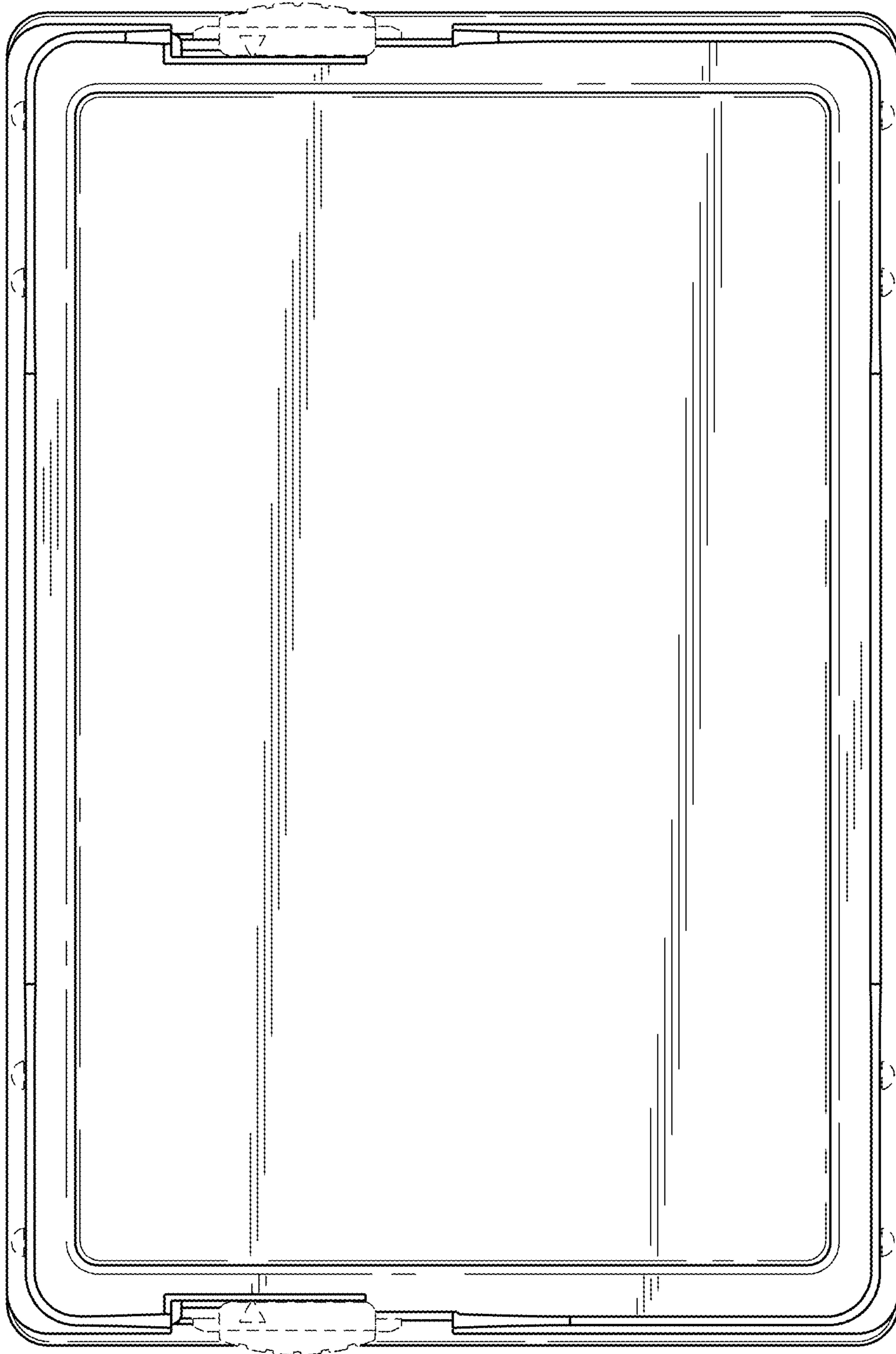

FIG. 22

FIG. 23



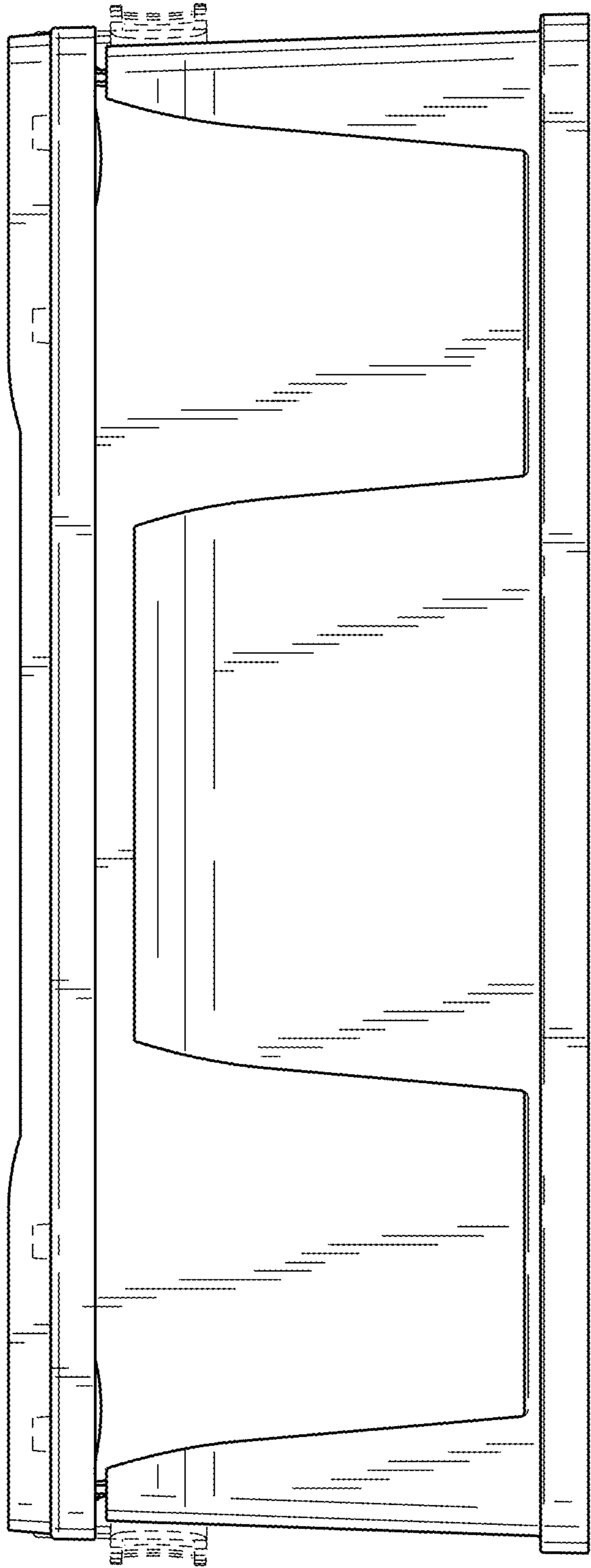

FIG. 24

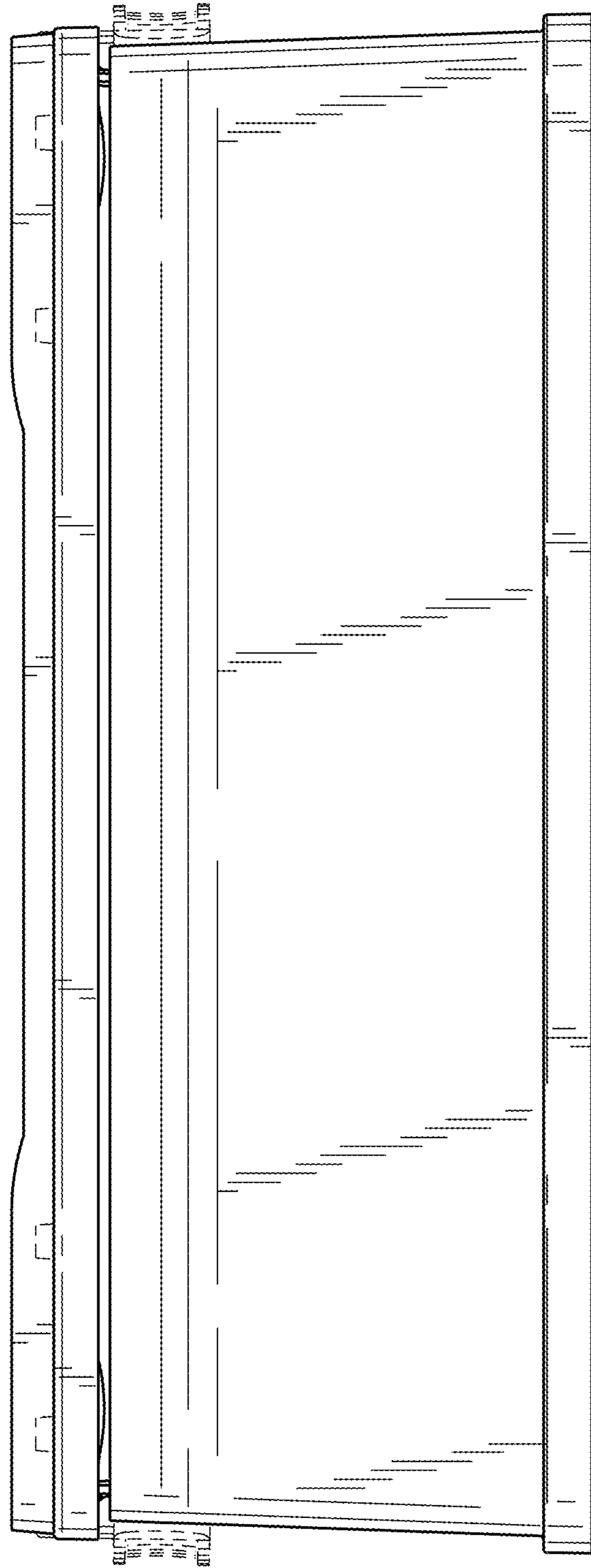

FIG. 25

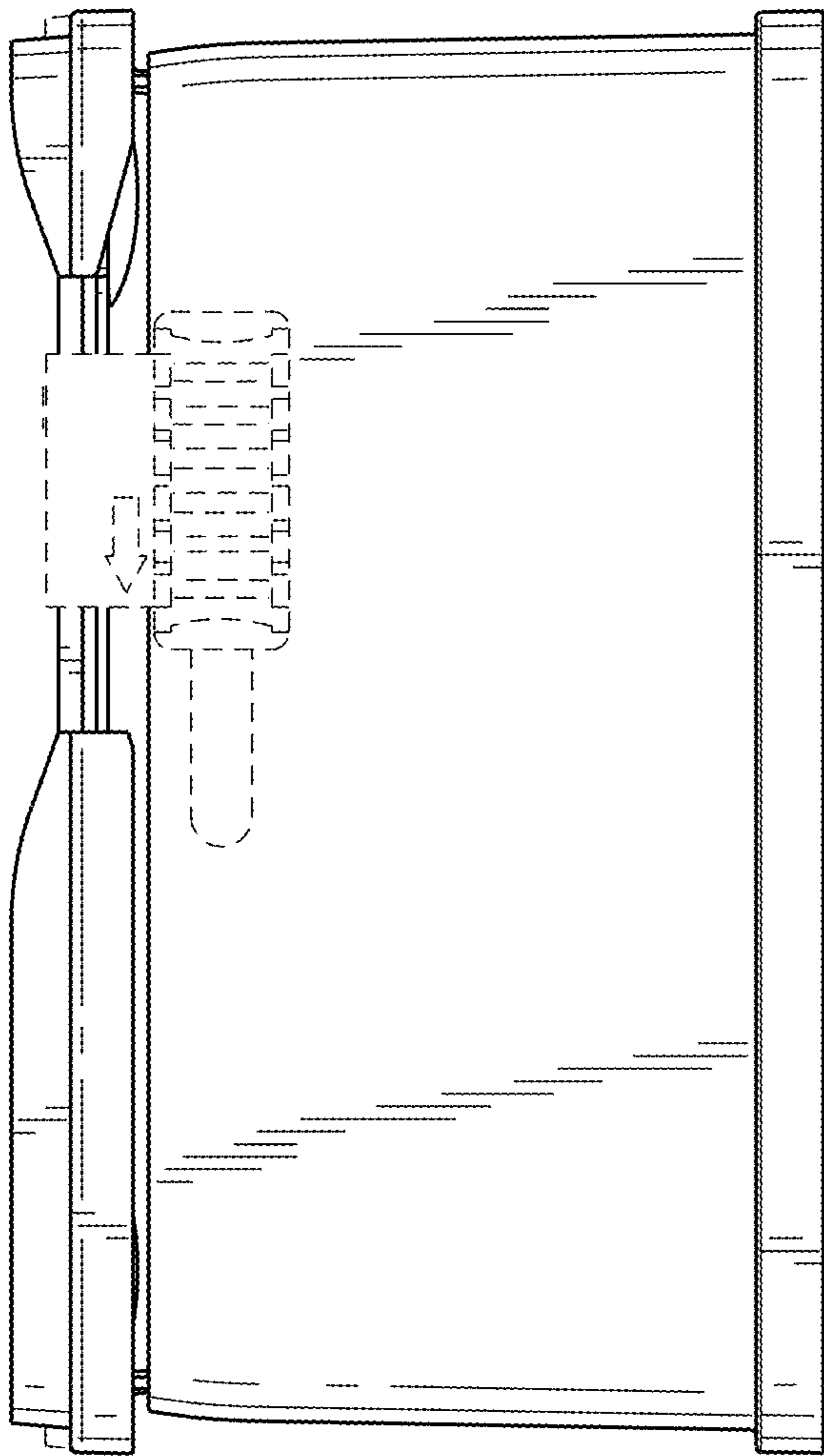

FIG. 26

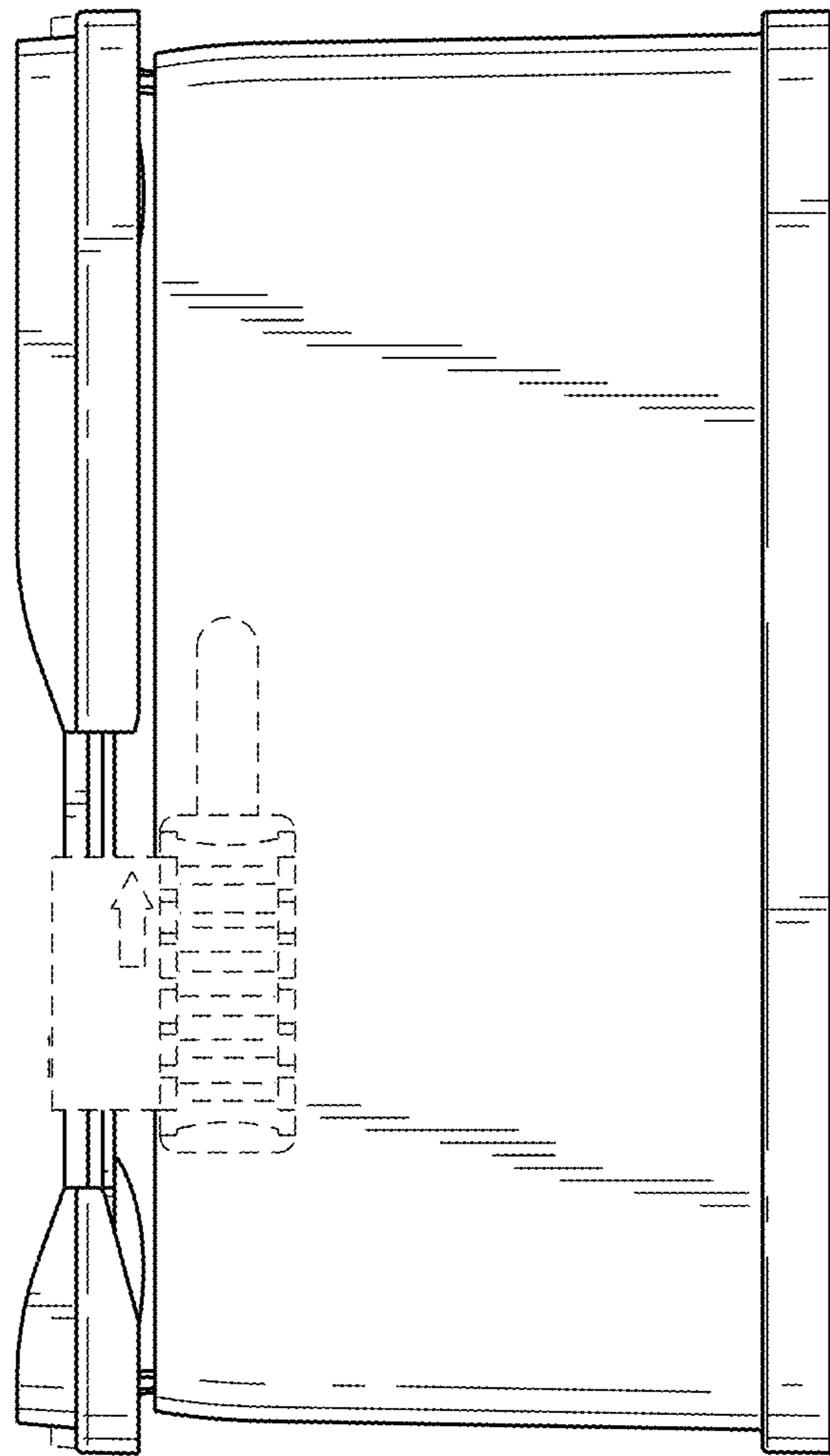

FIG. 27

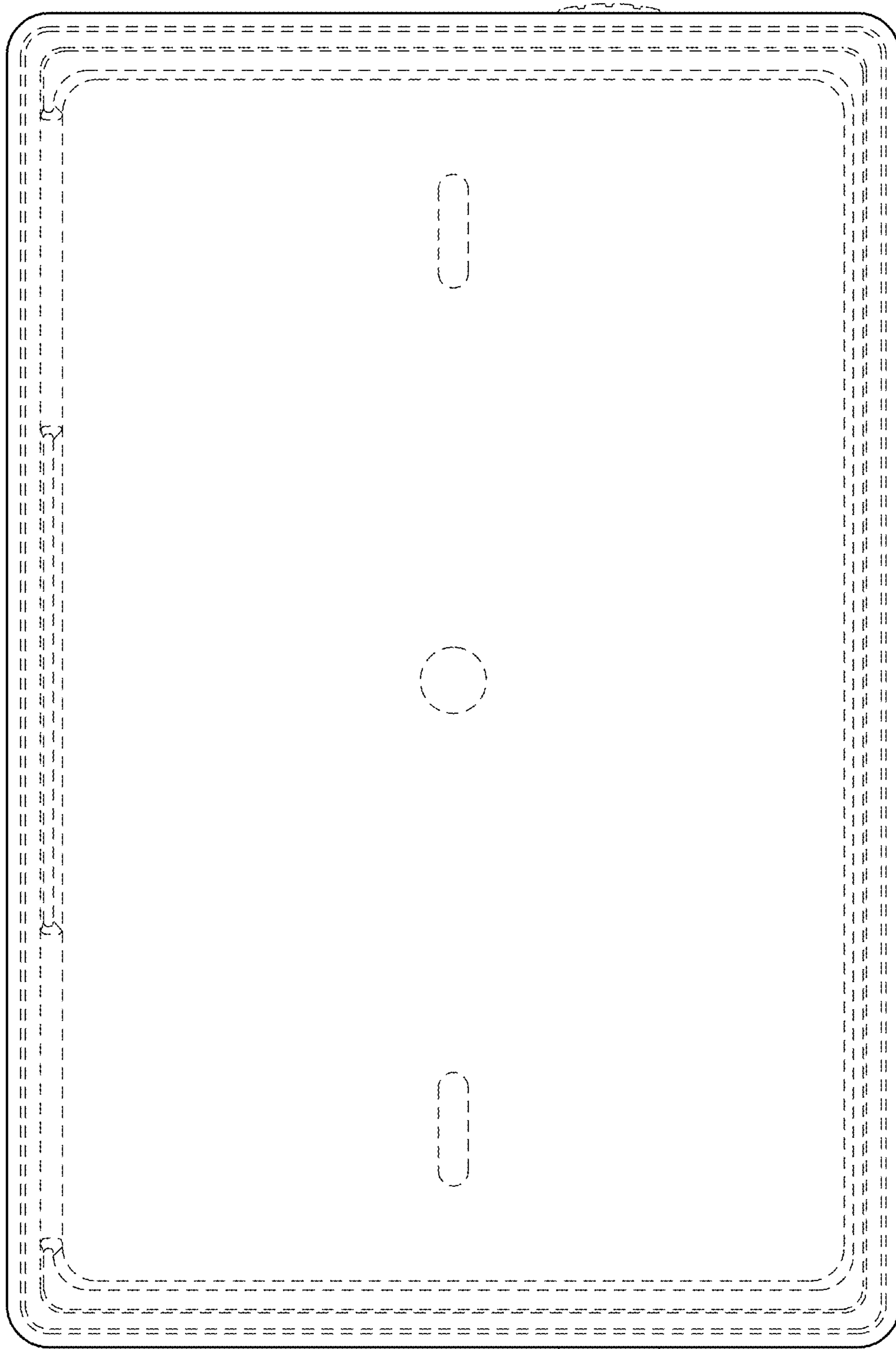

FIG. 28

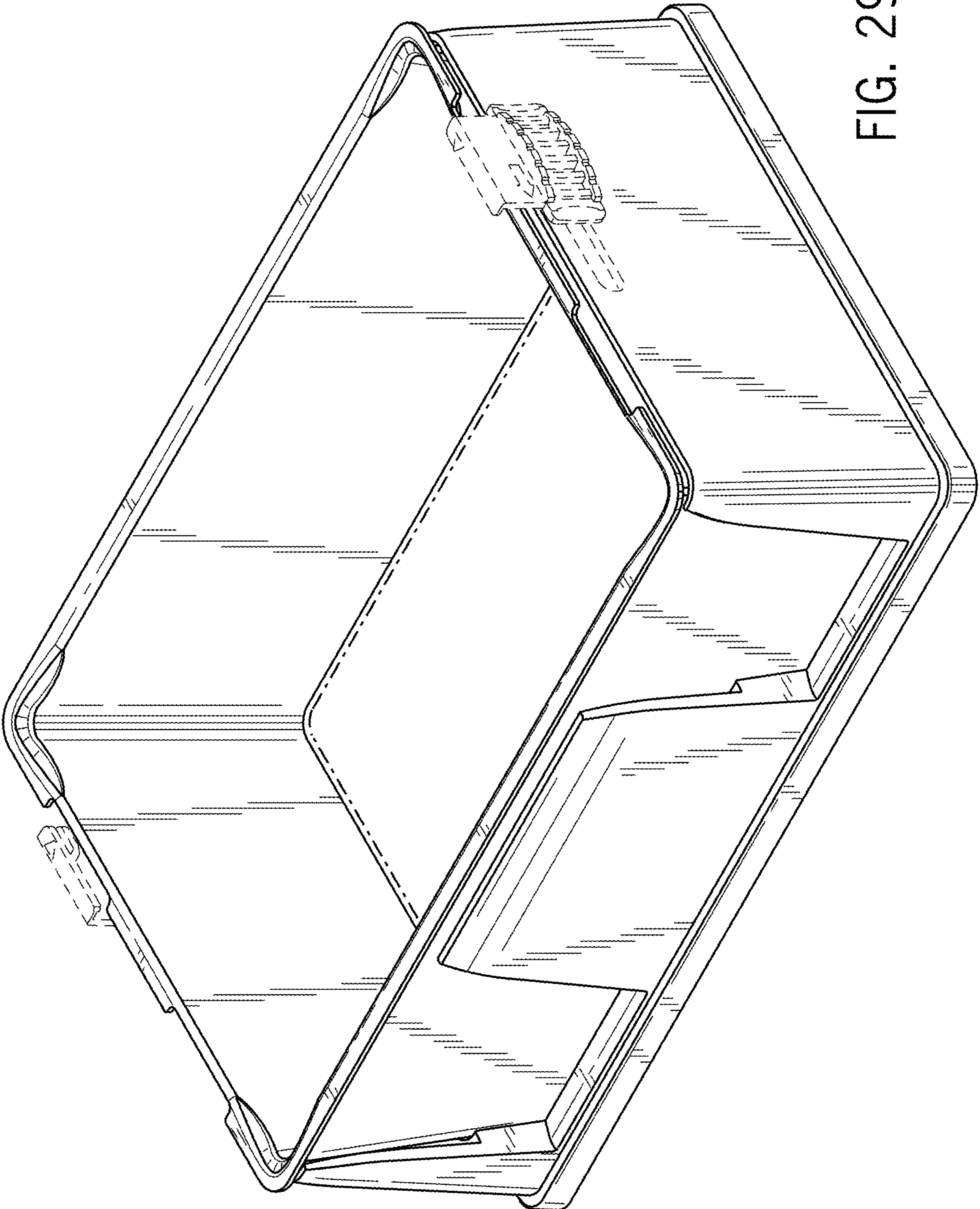
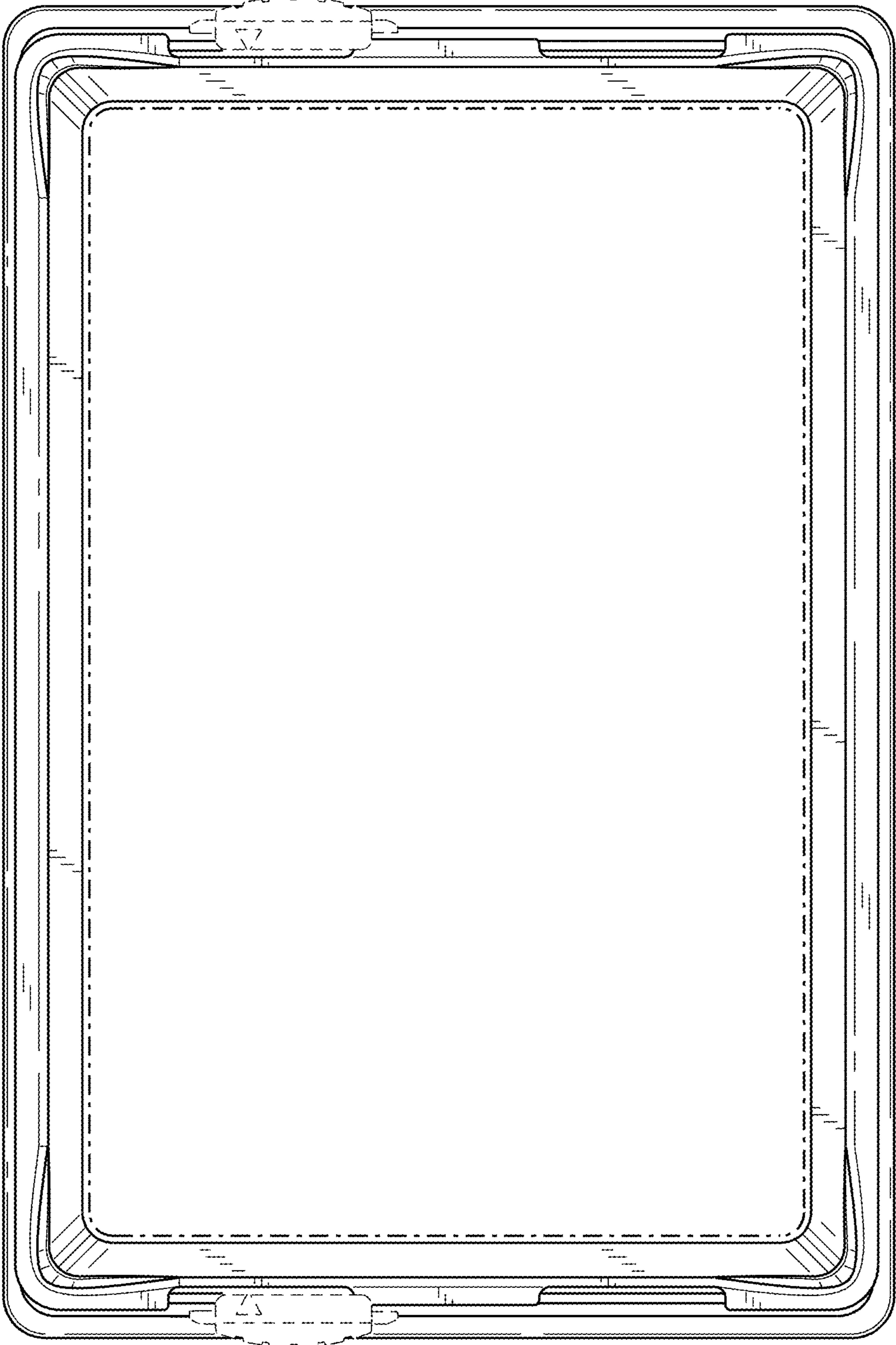

FIG. 29

FIG. 30



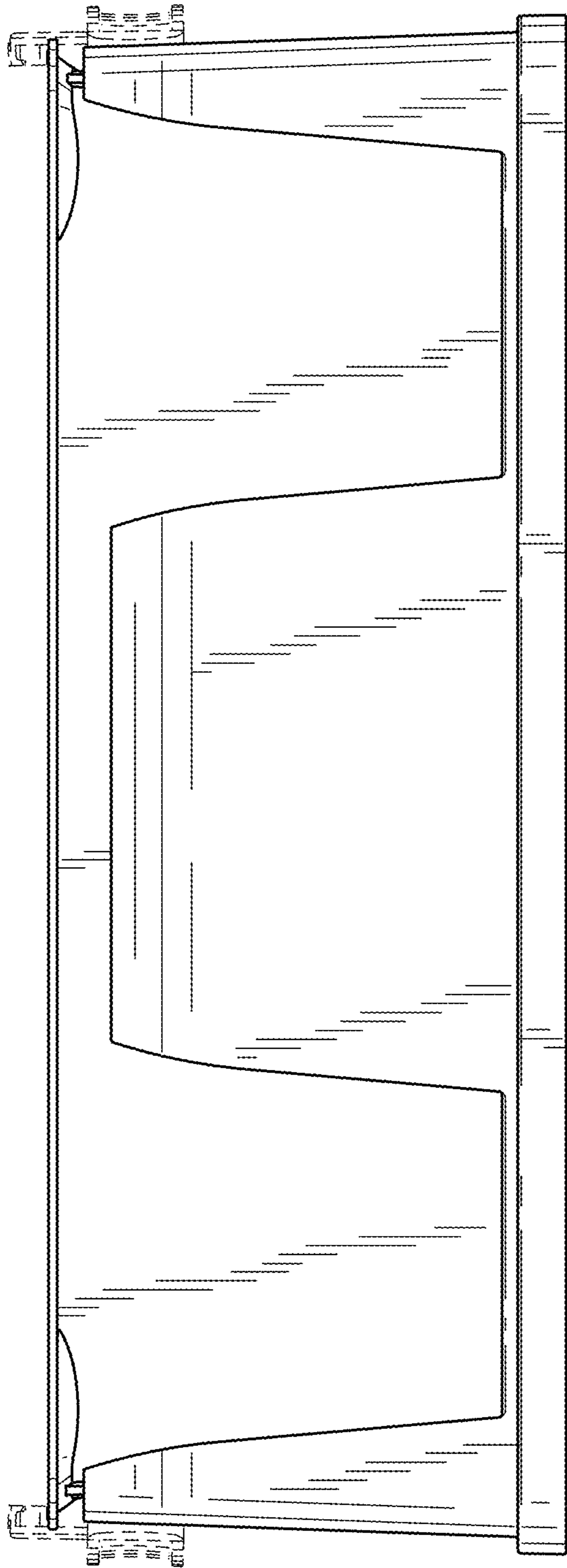

FIG. 31

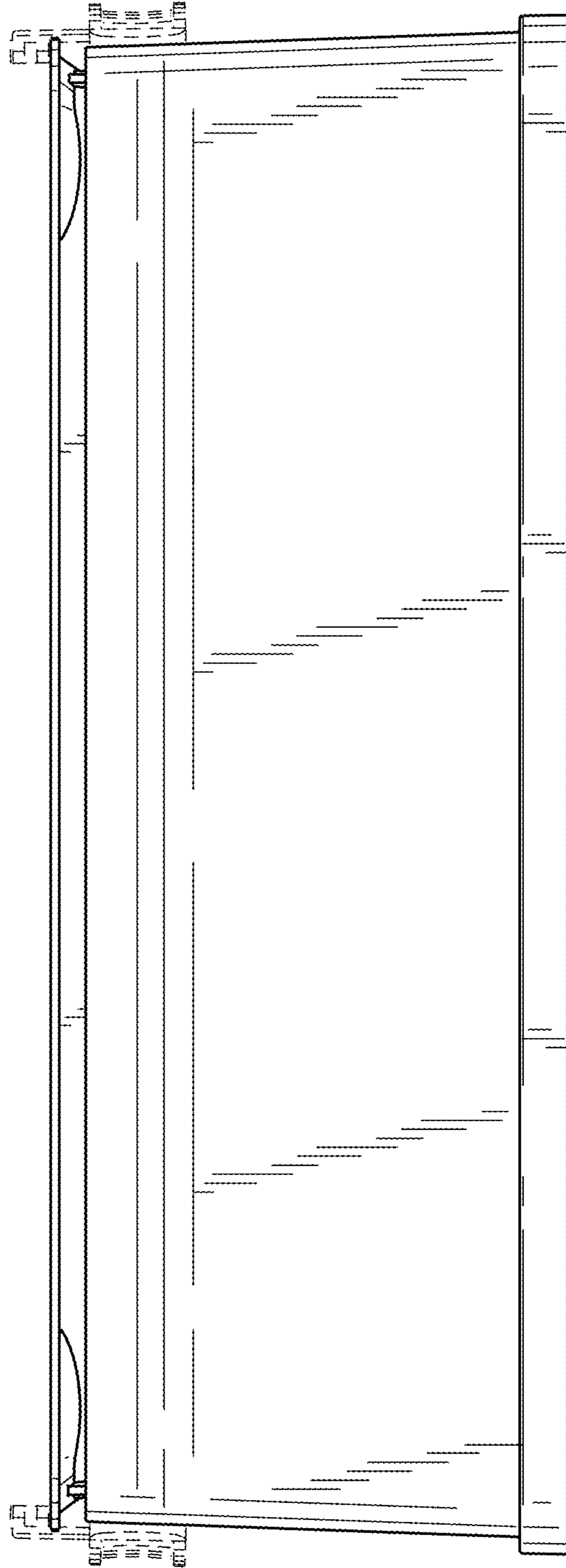

FIG. 32

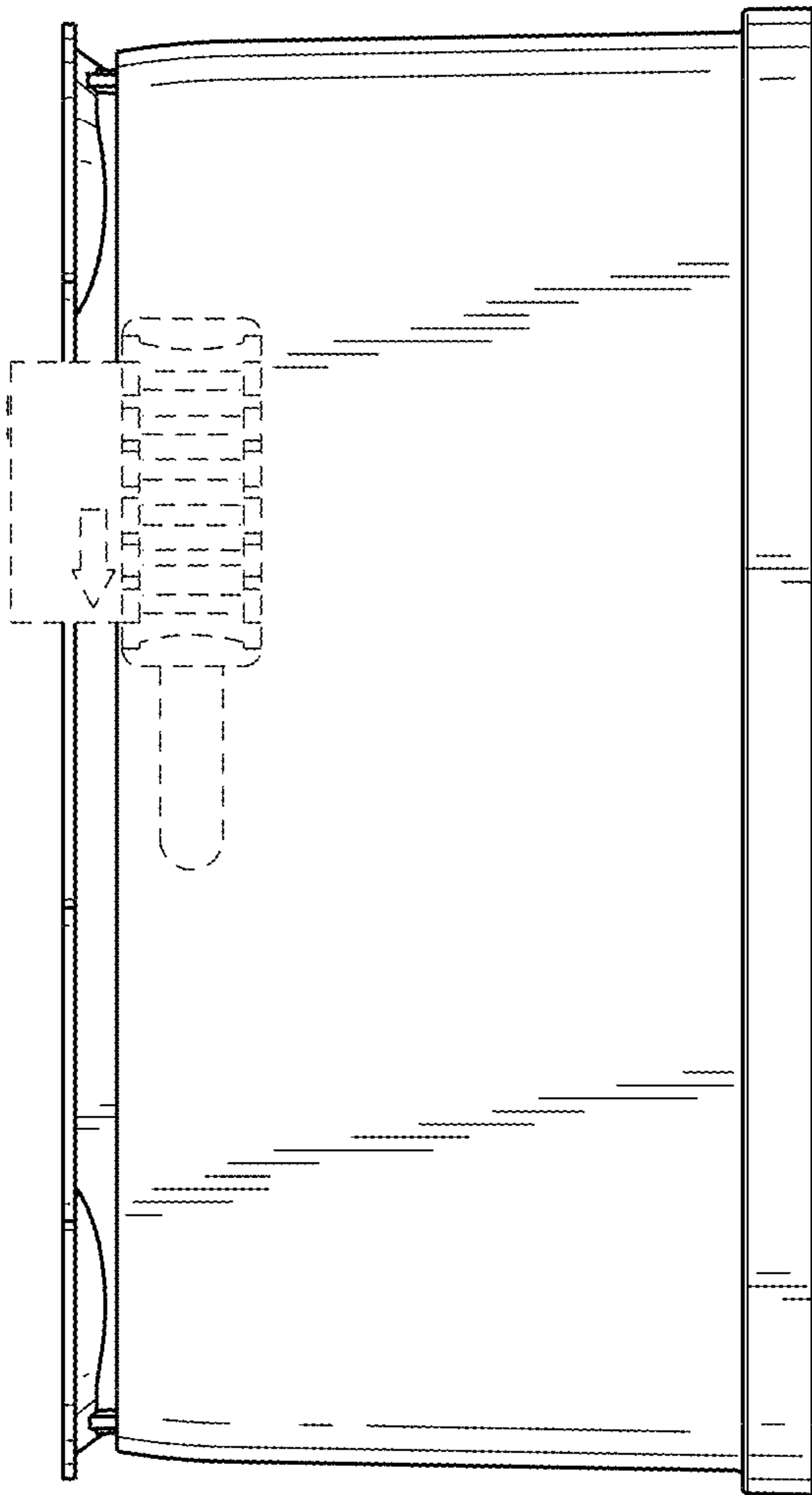

FIG. 33

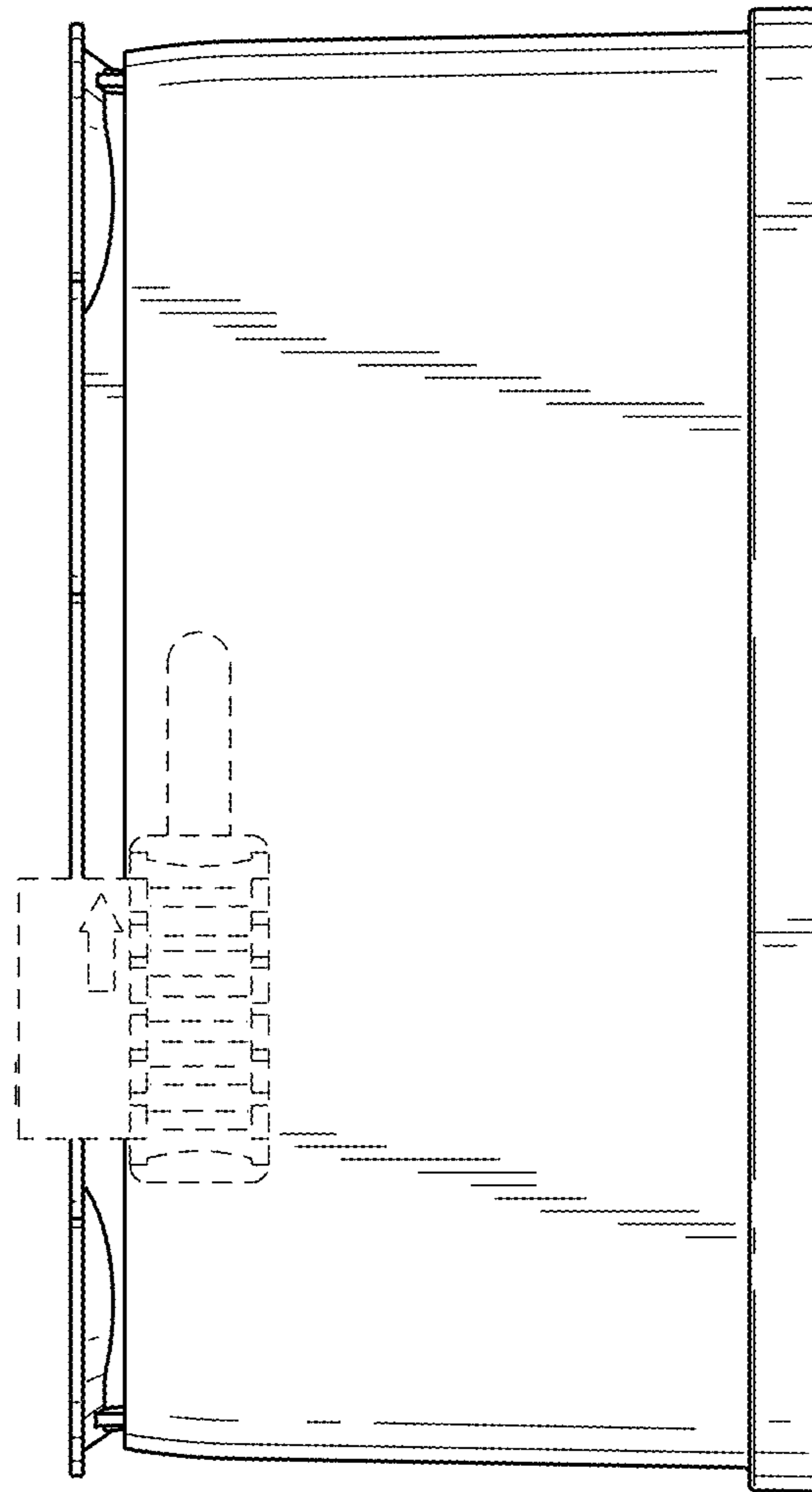

FIG. 34

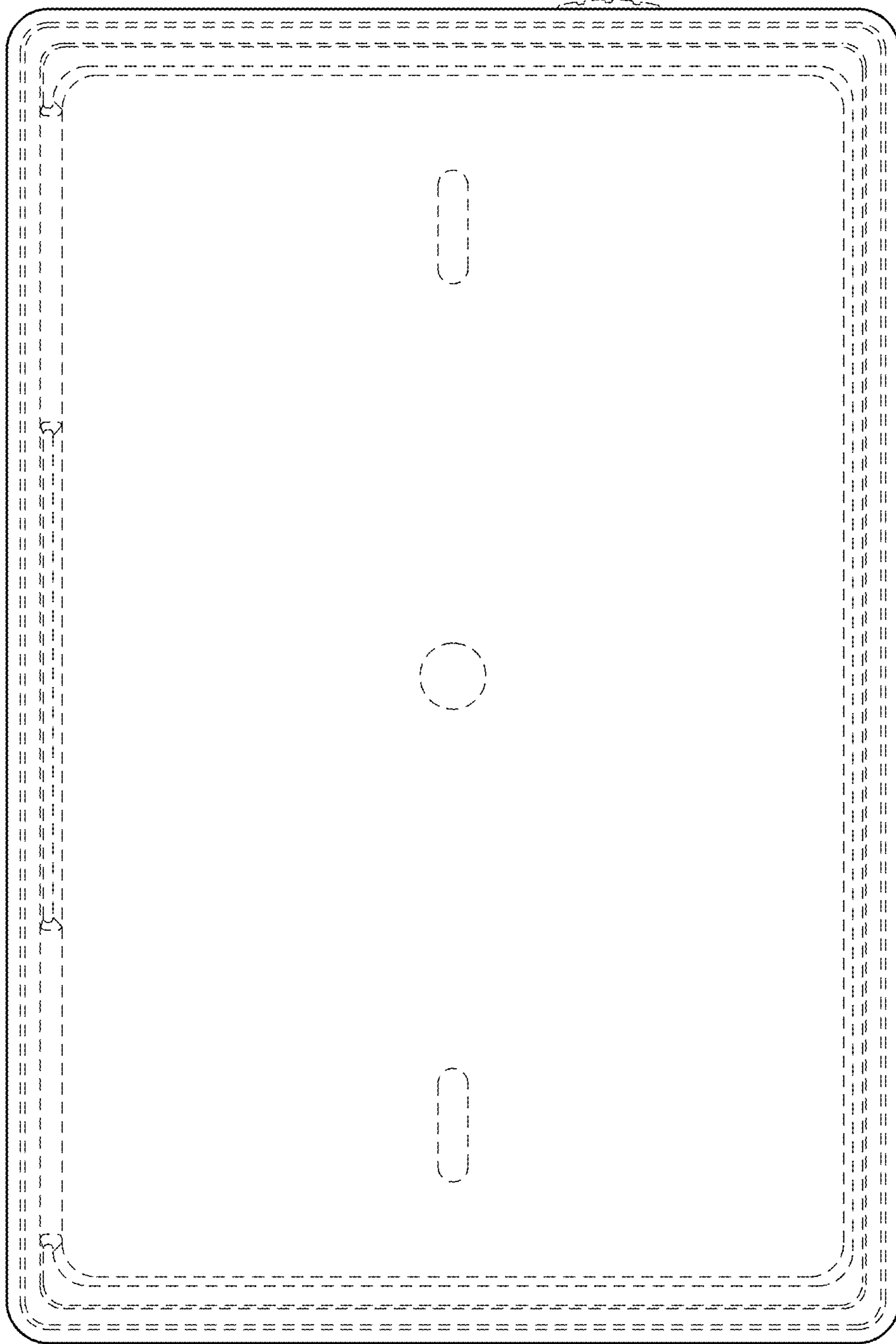

FIG. 35

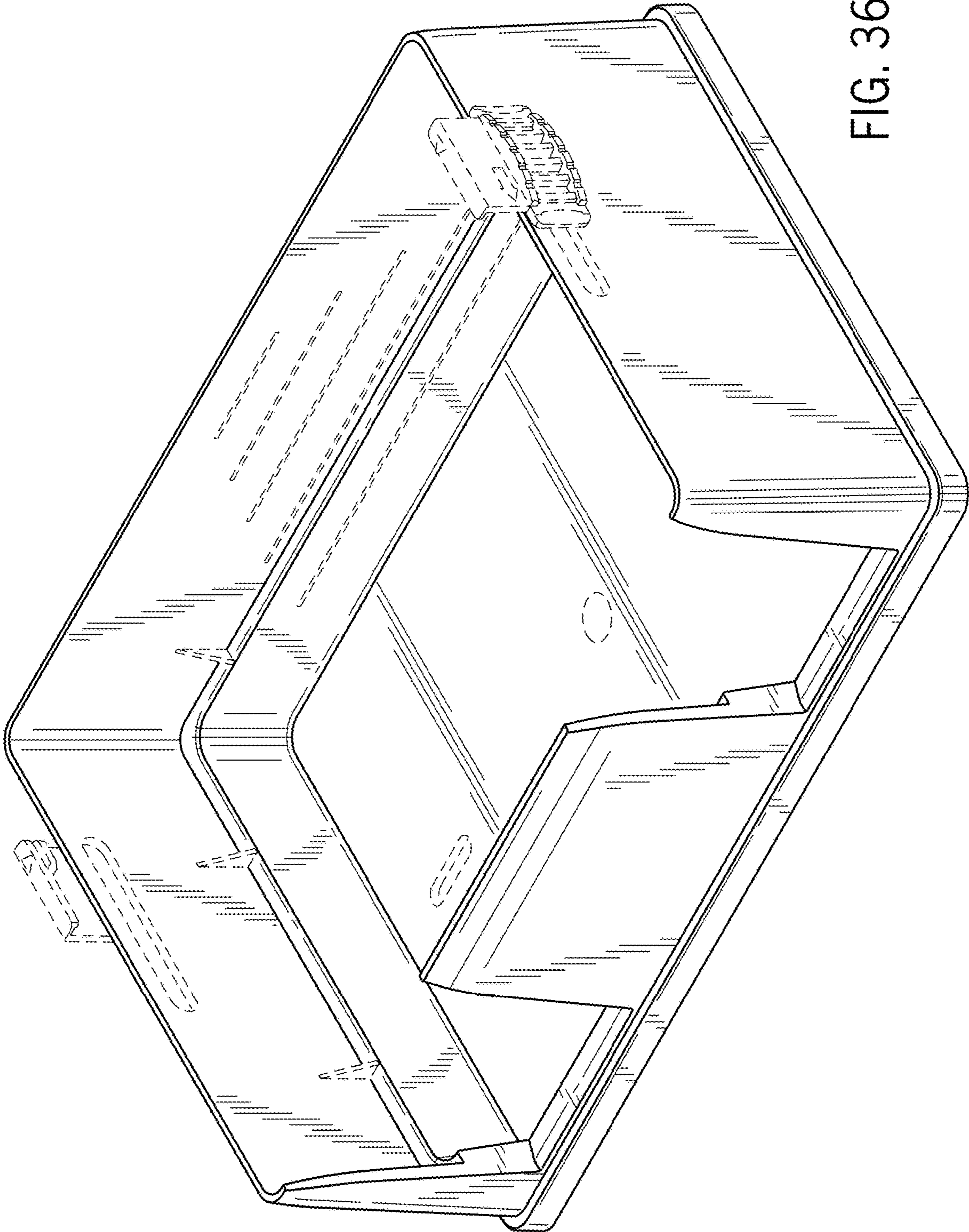
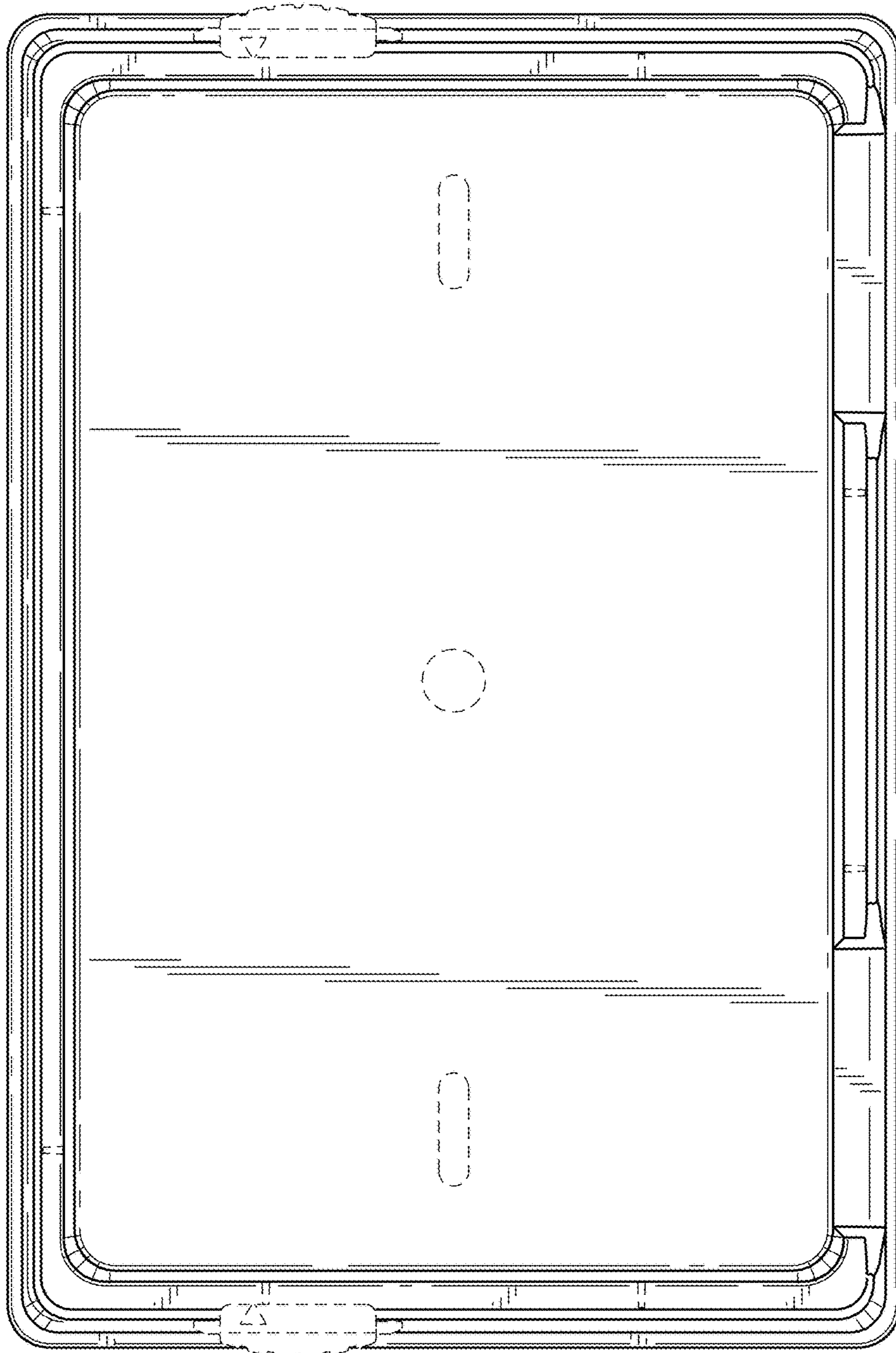

FIG. 36

FIG. 37



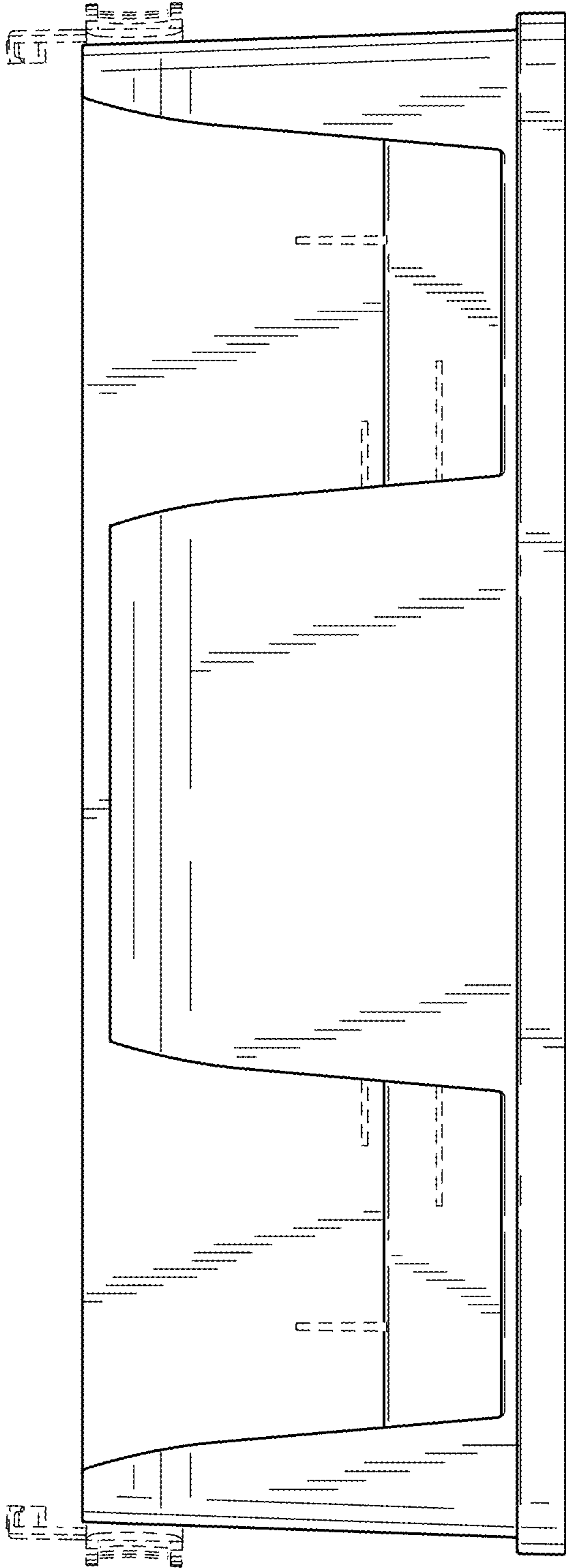

FIG. 38

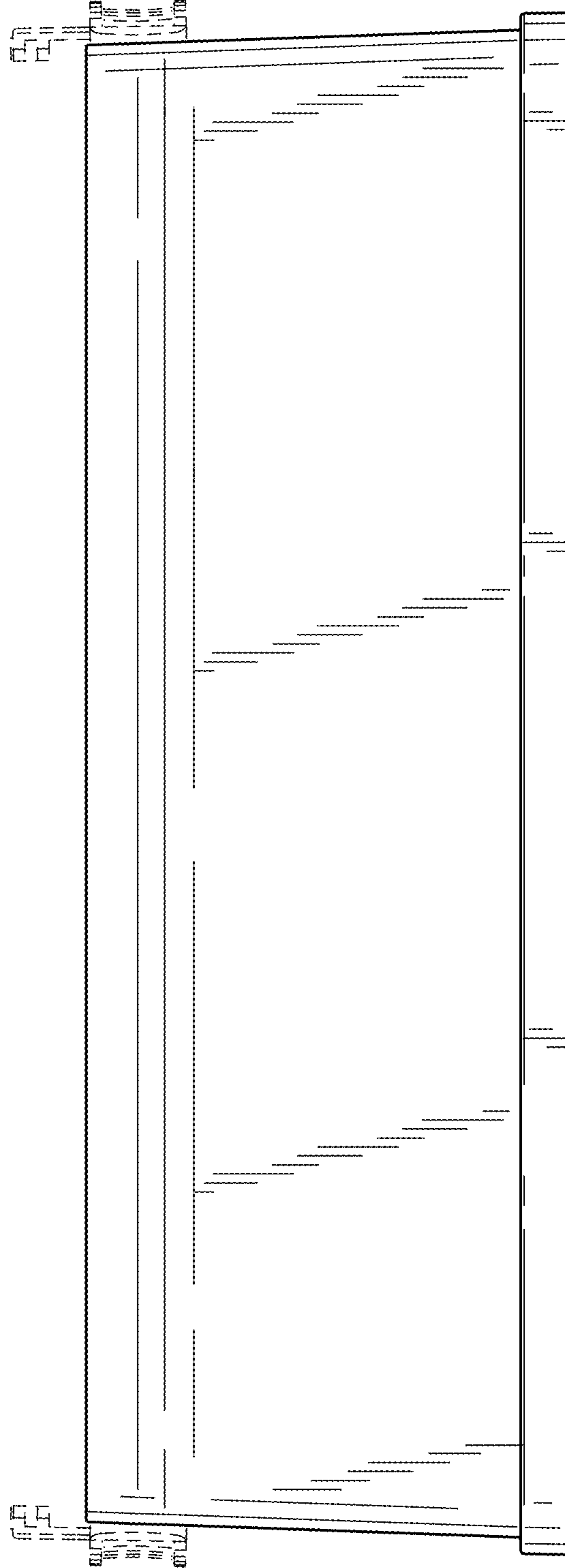

FIG. 39

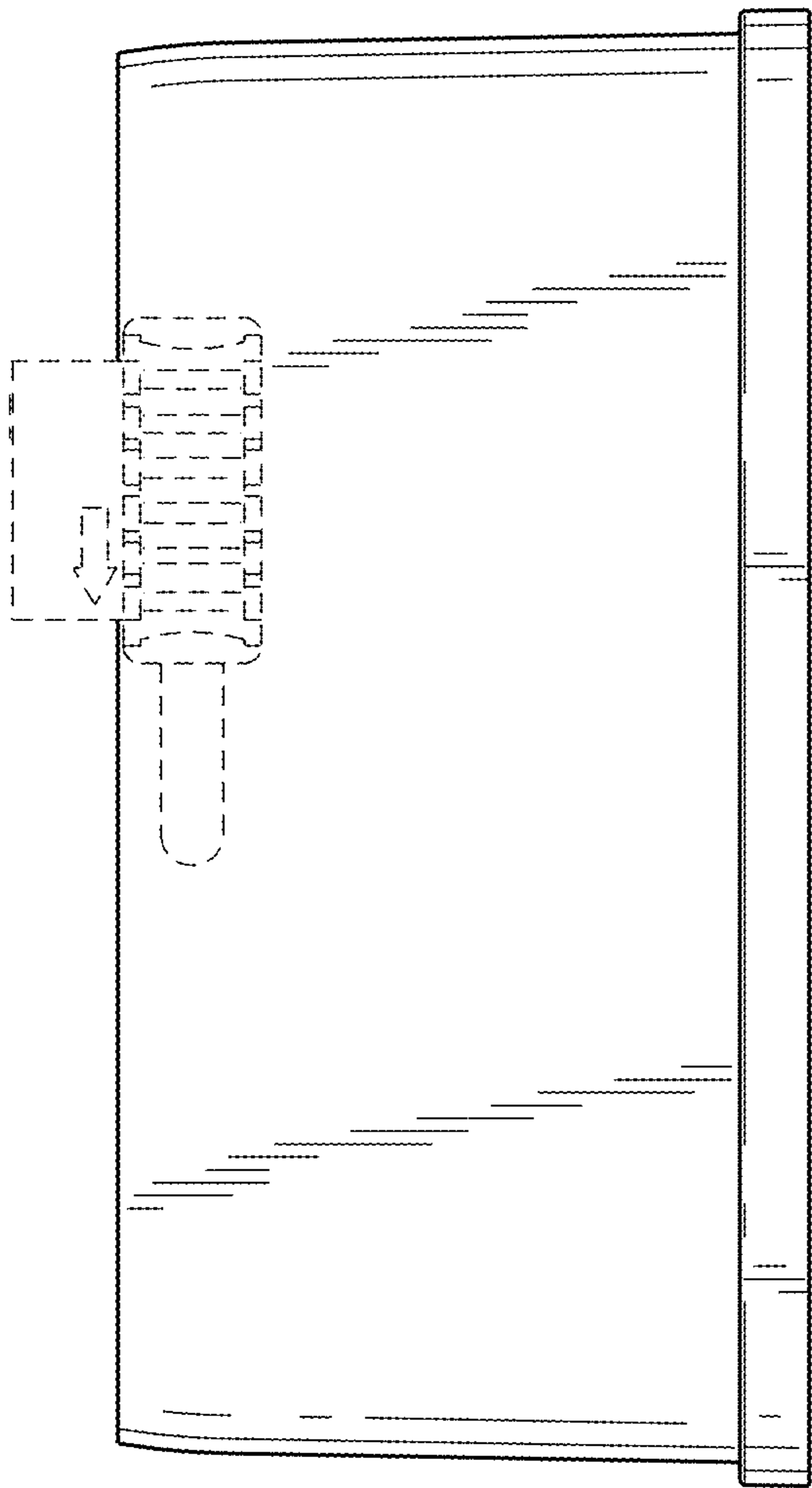

FIG. 40

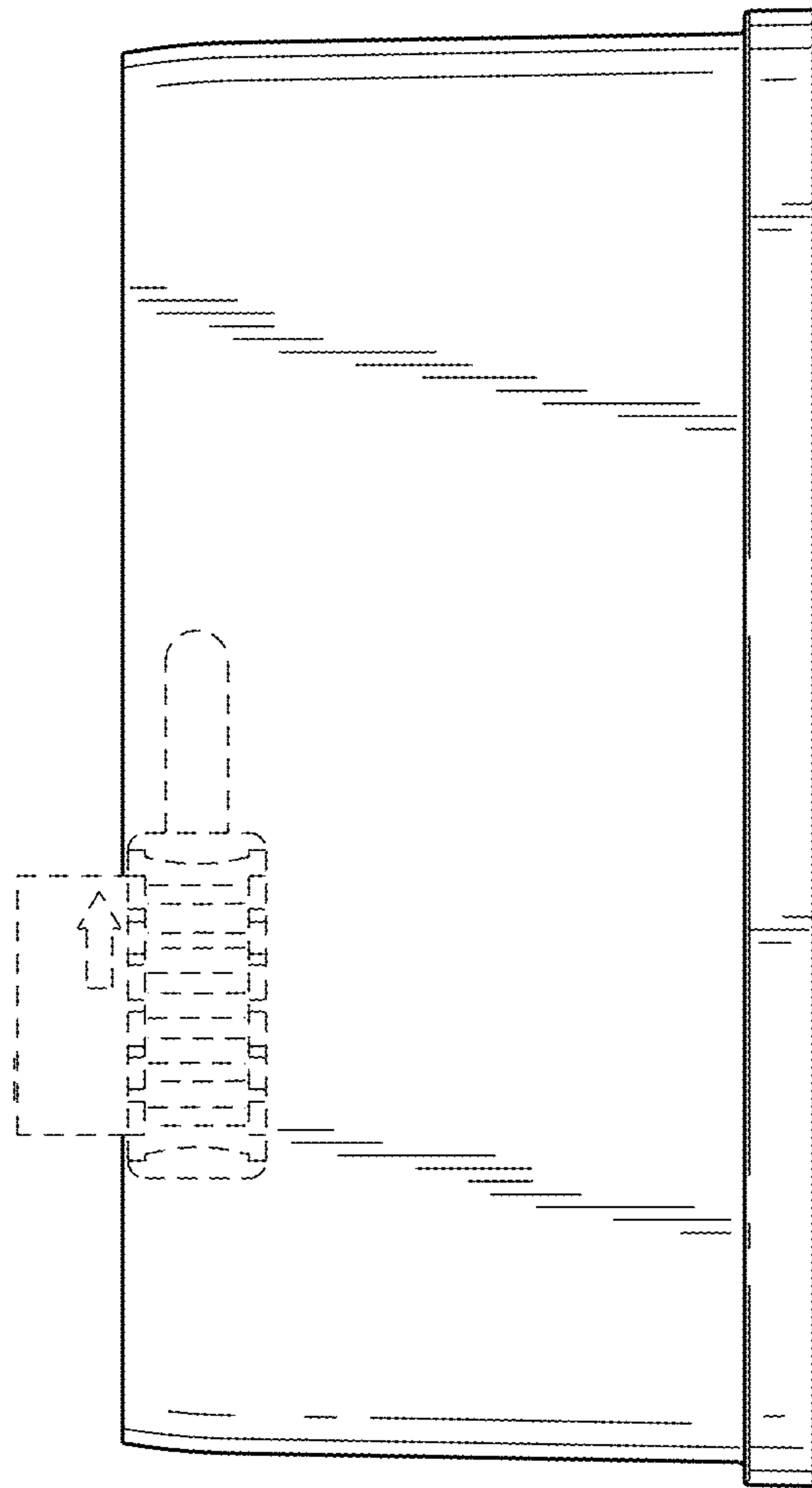

FIG. 41

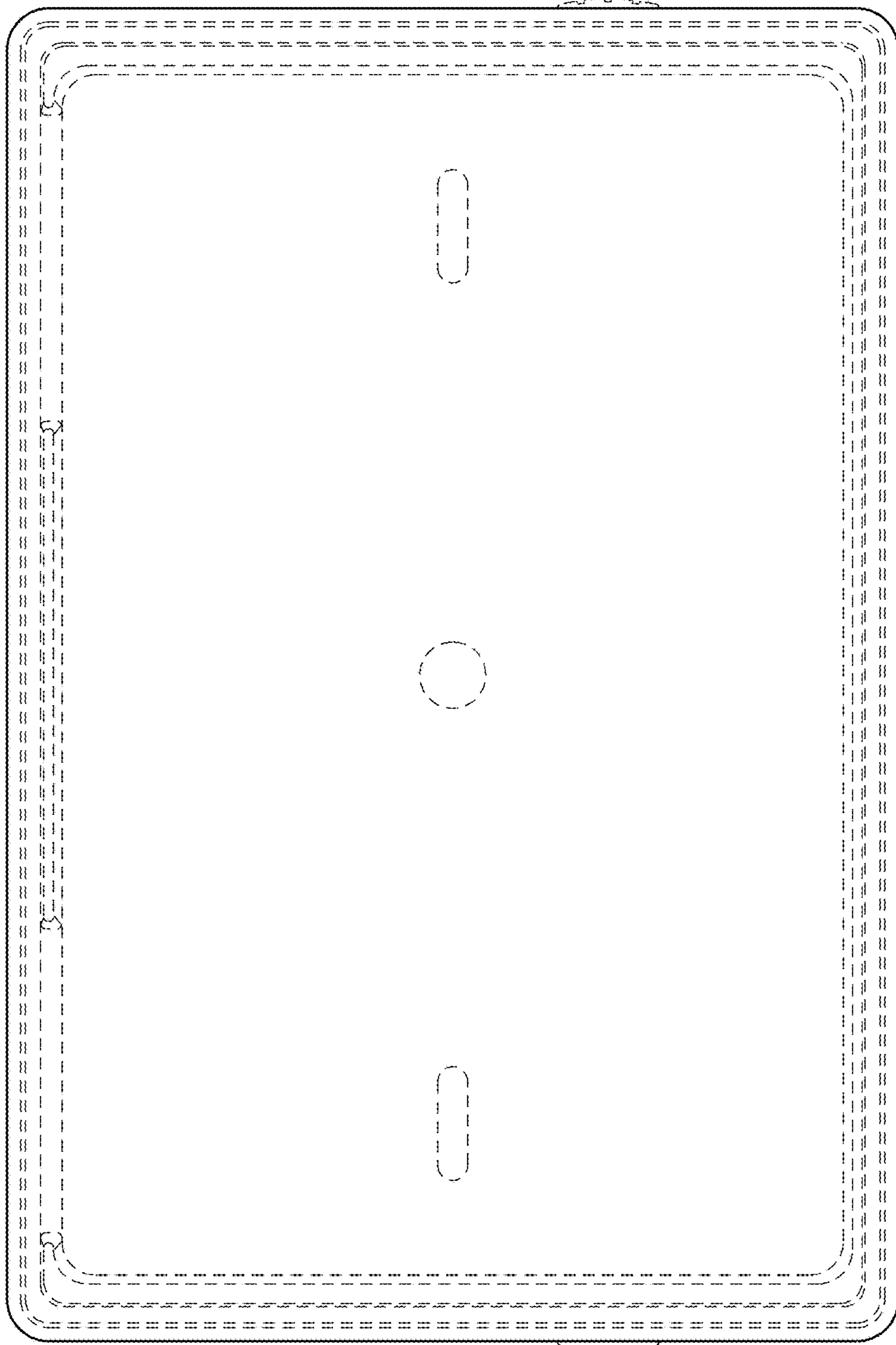

FIG. 42