

US00D840541S

(12) **United States Design Patent** (10) **Patent No.:** **US D840,541 S**  
**Yanagihara** (45) **Date of Patent:** **\*\* Feb. 12, 2019**

(54) **ULTRASONIC DIAGNOSIS APPARATUS**

(71) Applicant: **General Electric Company,**  
Schenectady, NY (US)

(72) Inventor: **Koji Yanagihara,** Tokyo (JP)

(73) Assignee: **General Electric Company,**  
Schenectady, NY (US)

(\*\*) Term: **15 Years**

(21) Appl. No.: **29/573,686**

(22) Filed: **Aug. 9, 2016**

(30) **Foreign Application Priority Data**

Mar. 17, 2016 (JP) ..... 2016-005899

(51) **LOC (11) Cl.** ..... **24-01**

(52) **U.S. Cl.**  
USPC ..... **D24/160**

(58) **Field of Classification Search**

USPC ..... D24/107, 133, 137, 138, 141, 158-161,  
D24/164, 165, 167, 170, 185-187;  
D10/57, 60, 78, 80; 600/407, 439, 446,  
600/459, 461; 378/98.7, 98.8, 189  
CPC ... A61B 8/0437; A61B 8/0883; A61B 8/4405;  
A61B 8/4411; A61B 8/4427; A61B  
8/445; A61B 8/4455; A61B 8/4461; A61B  
8/4483; A61B 8/46; A61B 8/462; A61B  
5/0095

See application file for complete search history.

(56) **References Cited**

**U.S. PATENT DOCUMENTS**

D630,752 S \* 1/2011 Suzuki ..... D24/158  
D662,208 S \* 6/2012 Otoha ..... D24/185  
D707,359 S \* 6/2014 Kim ..... D24/185  
D711,539 S \* 8/2014 Hunt ..... D24/158  
D713,035 S \* 9/2014 Kim ..... D24/158

D716,949 S \* 11/2014 Baba ..... D24/160  
D727,504 S \* 4/2015 Ninomiya ..... D24/158  
9,055,910 B2 \* 6/2015 Nakajima ..... A61B 8/4405  
2008/0009728 A1 \* 1/2008 Malchow ..... A61B 8/0833  
600/437  
2009/0156935 A1 \* 6/2009 Frisa ..... A61B 8/14  
600/447  
2011/0201927 A1 \* 8/2011 Hayakawa ..... A61B 8/4405  
600/437  
2016/0270764 A1 \* 9/2016 Wodecki ..... A61B 8/462

\* cited by examiner

*Primary Examiner* — Anhdao Doan

*Assistant Examiner* — Mary Shannon Malley

(74) *Attorney, Agent, or Firm* — McCoy Russell LLP

(57) **CLAIM**

The ornamental design for an ultrasonic diagnosis apparatus,  
as shown and described.

**DESCRIPTION**

FIG. 1 is a front view of a design for an ultrasonic diagnosis  
apparatus, as shown and described.

FIG. 2 is a back view of the ultrasonic diagnosis apparatus  
of FIG. 1.

FIG. 3 is a right side view of the ultrasonic diagnosis  
apparatus of FIG. 1.

FIG. 4 is a left side view of the ultrasonic diagnosis  
apparatus of FIG. 1.

FIG. 5 is a top view of the ultrasonic diagnosis apparatus of  
FIG. 1.

FIG. 6 is a bottom view of the ultrasonic diagnosis apparatus  
of FIG. 1.

FIG. 7 is a front perspective view of the ultrasonic diagnosis  
apparatus of FIG. 1; and,

FIG. 8 is a back perspective view of a design for the  
ultrasonic diagnosis apparatus of FIG. 1.

The broken lines show portions of the ultrasonic diagnosis  
apparatus that form no part of the claimed design.

**1 Claim, 8 Drawing Sheets**

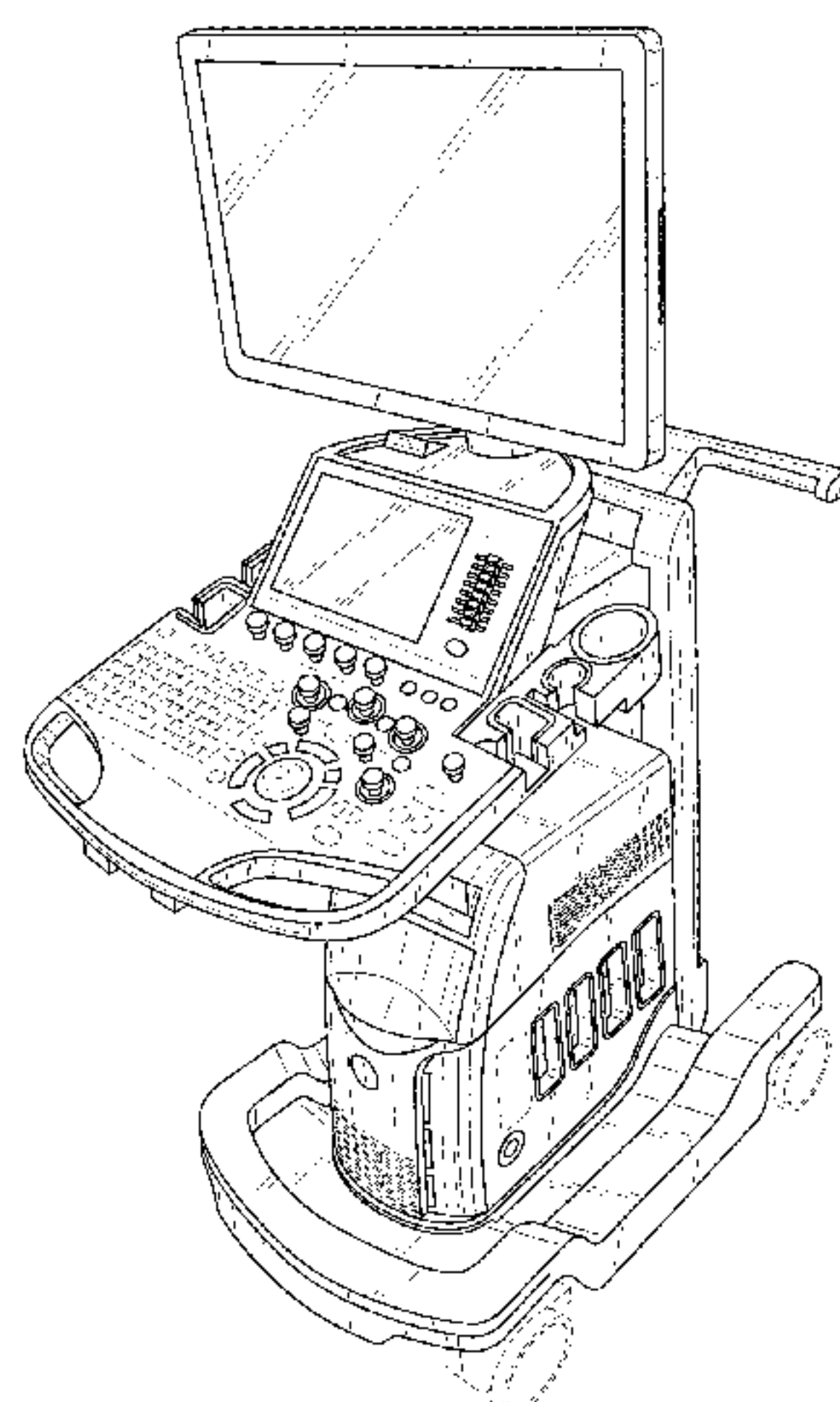

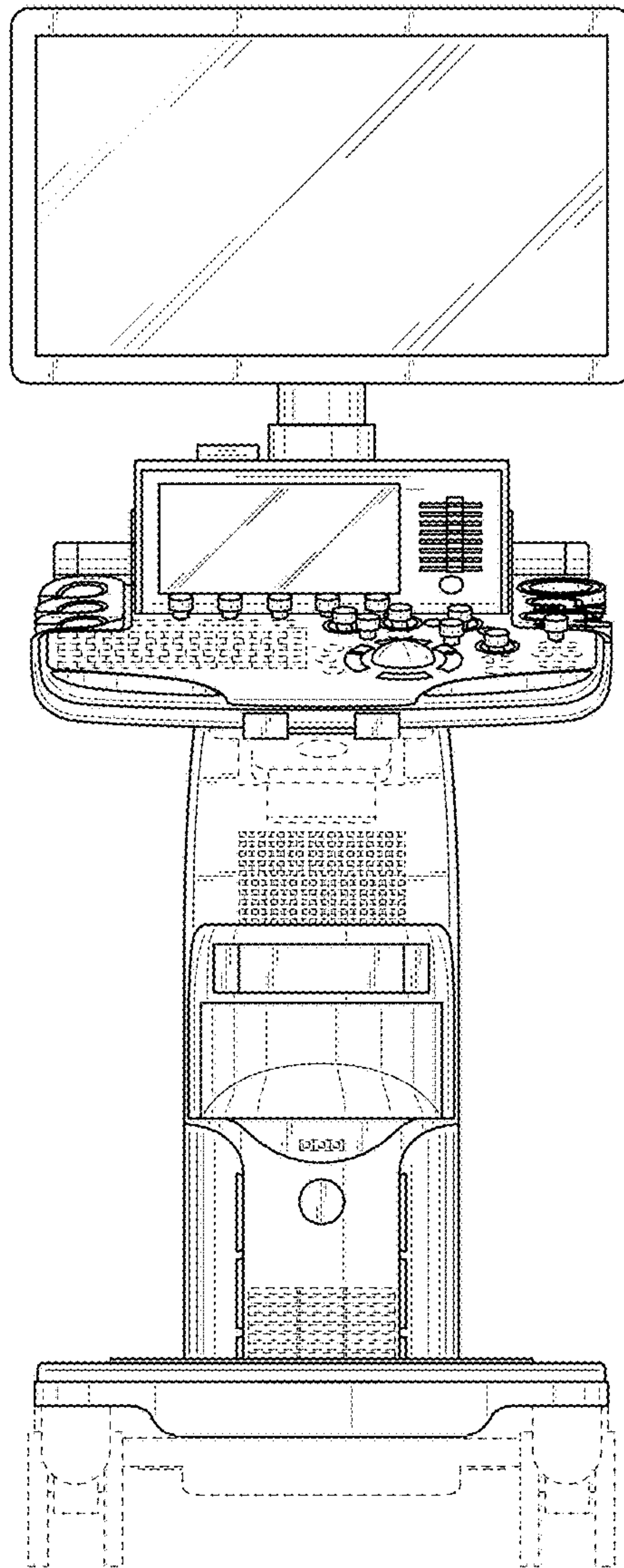

FIG. 1

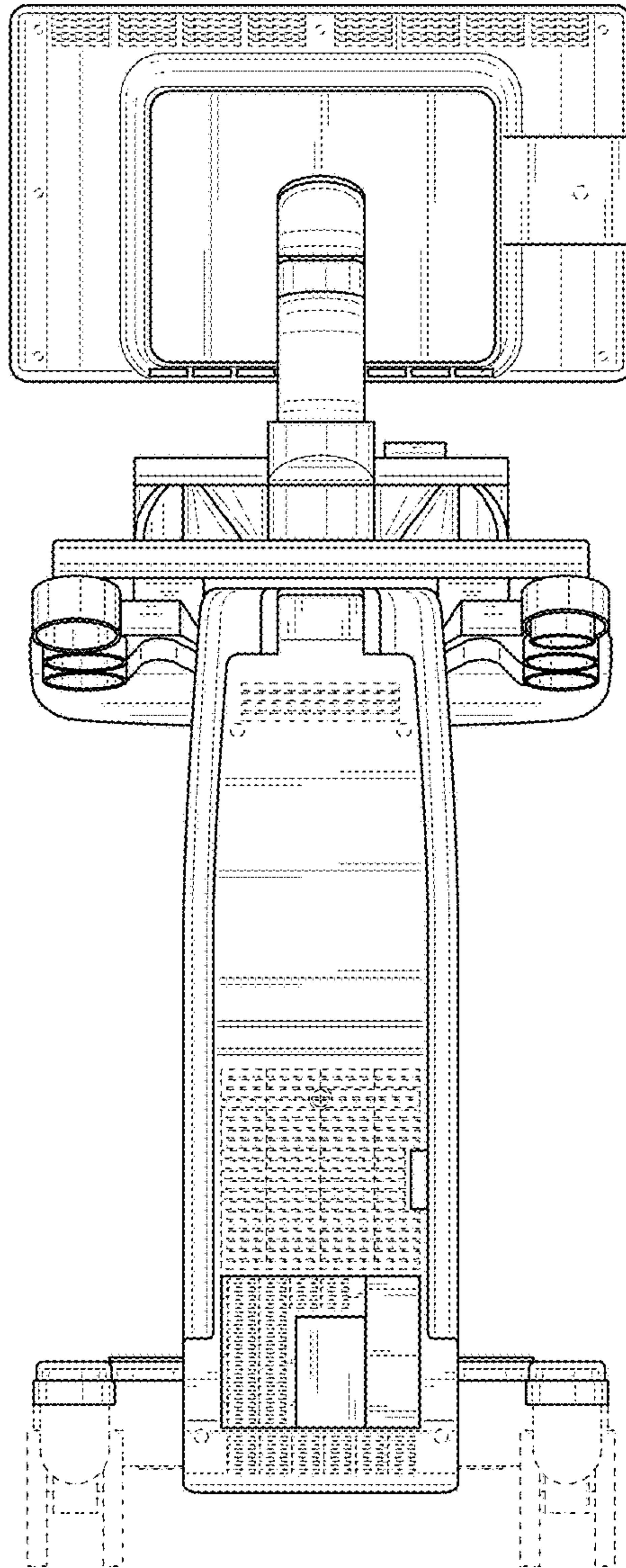

FIG. 2

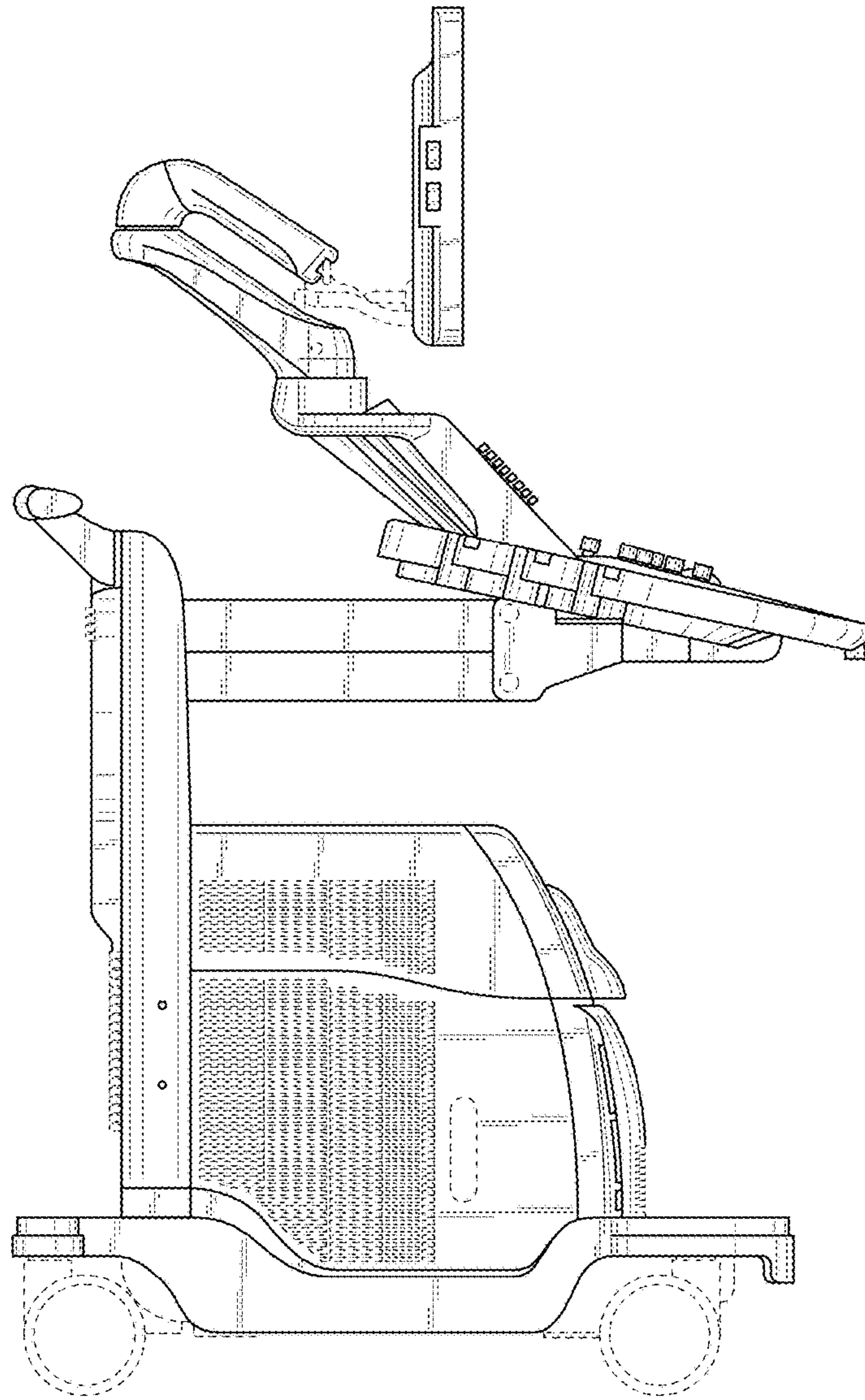

FIG. 3



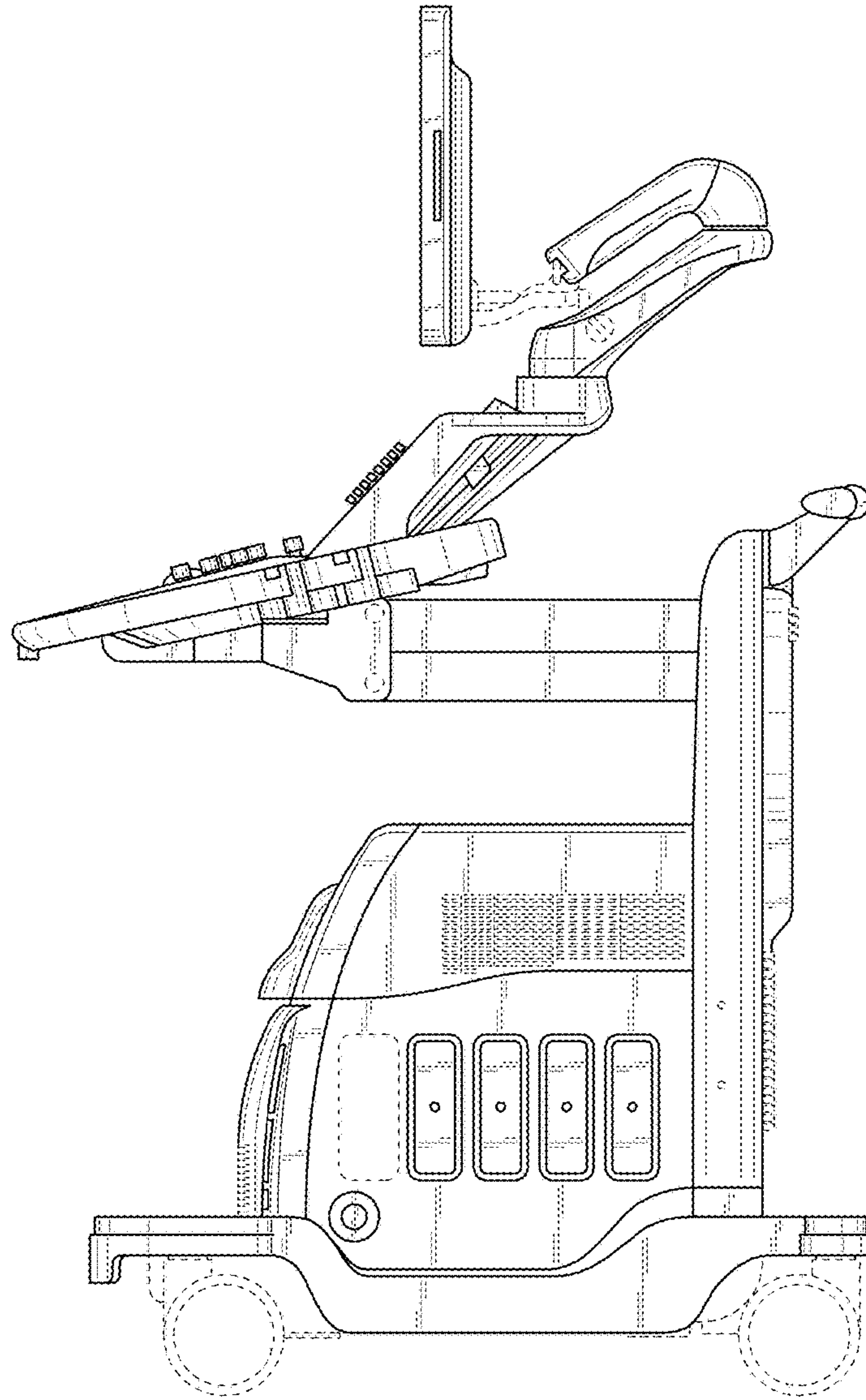

FIG. 4

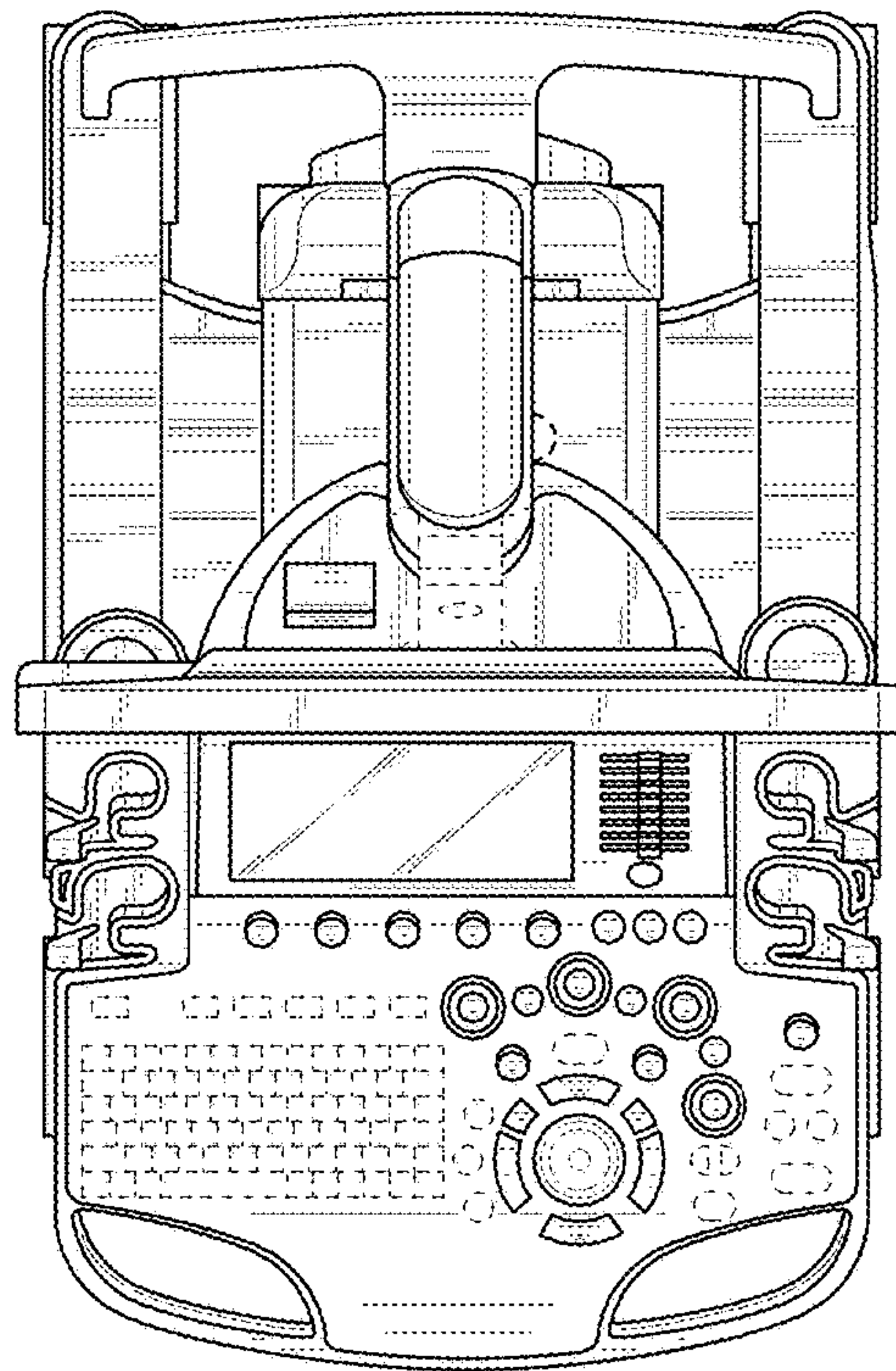

FIG. 5

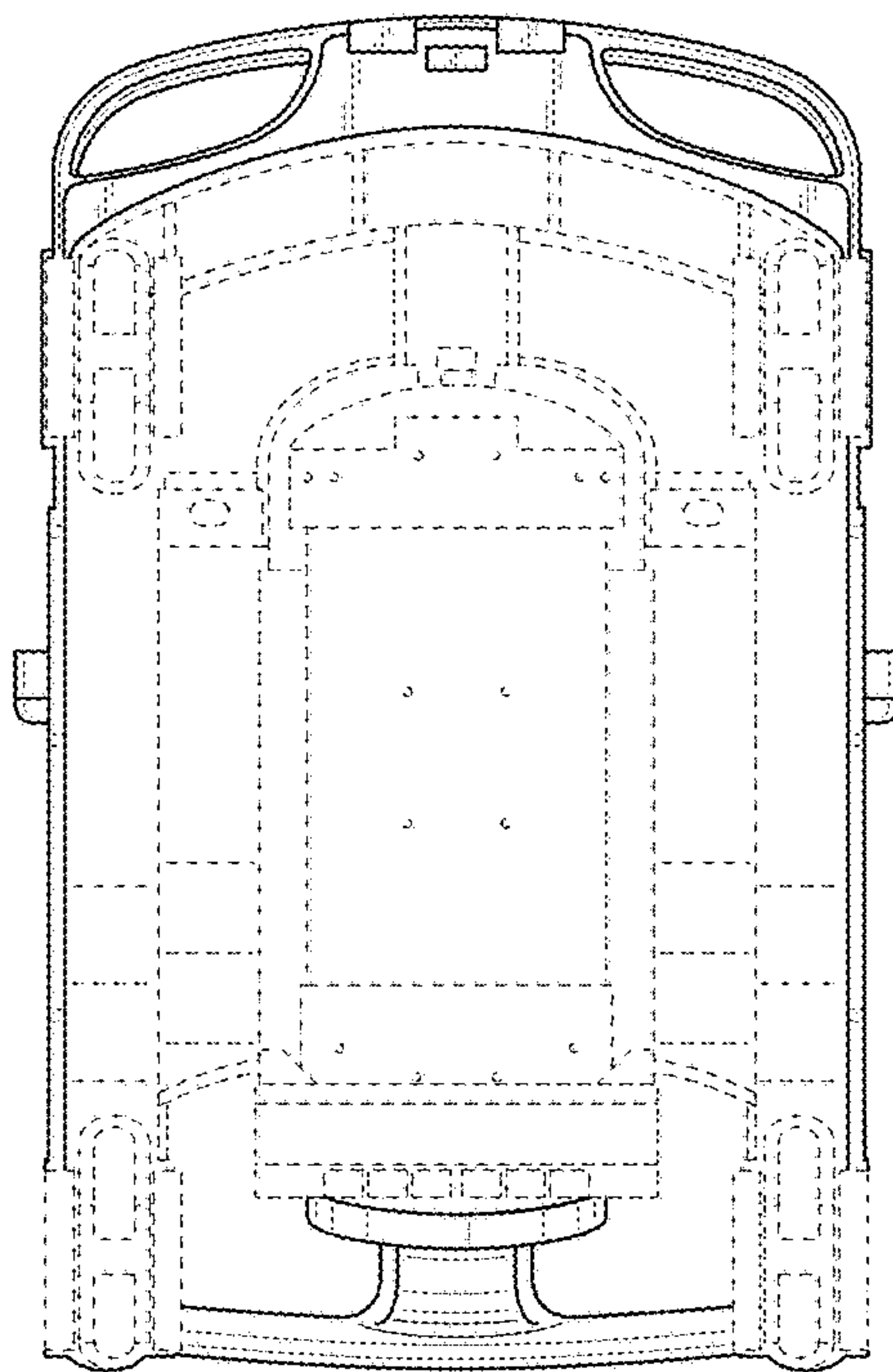

FIG. 6

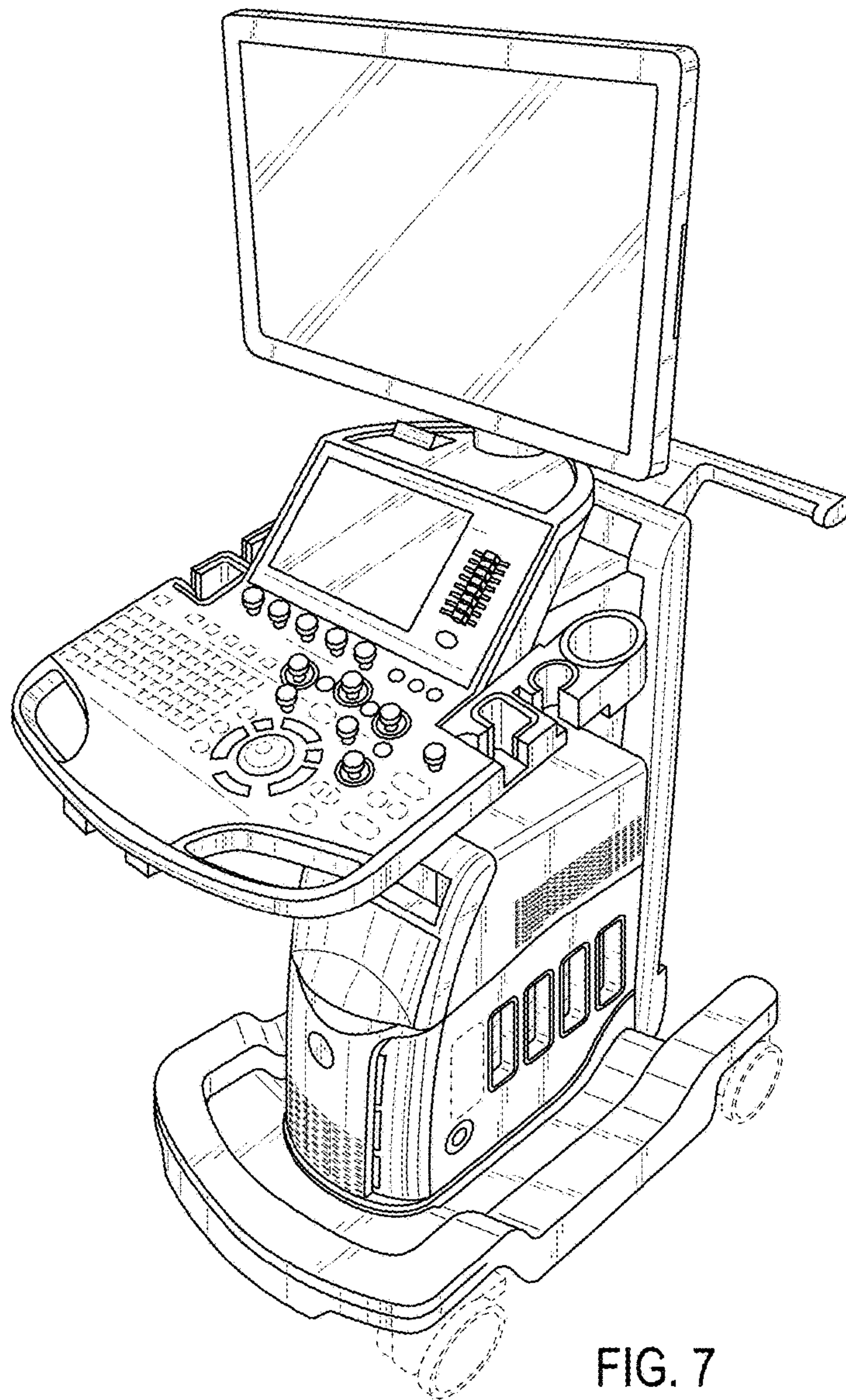

FIG. 7



