



US00D840494S

(12) **United States Design Patent** (10) **Patent No.:** **US D840,494 S**  
**Storch** (45) **Date of Patent:** **\*\* Feb. 12, 2019**

(54) **FIREARM HAND GUARD**

(71) Applicant: **Midwest Industries, Inc.**, Waukesha, WI (US)

(72) Inventor: **Troy Storch**, Wales, WI (US)

(73) Assignee: **Midwest Industries, Inc.**, Waukesha, WI (US)

(\*\*) Term: **15 Years**

(21) Appl. No.: **29/607,212**

(22) Filed: **Jun. 12, 2017**

(51) **LOC (11) Cl.** ..... **22-01**

(52) **U.S. Cl.**  
USPC ..... **D22/108**

(58) **Field of Classification Search**

USPC ..... D22/103, 108; D21/572-575; D14/418;  
42/71.01, 75.01, 75.02, 90, 94, 134, 136,  
42/139, 125, 72, 111; 89/40.06, 41.19,  
89/37.04, 33.04, 191.01, 200-204;  
124/66, 67, 72, 74  
CPC ..... F41C 23/00; F41C 27/00; F41C 27/06;  
F41C 23/10; F41C 23/14; F41C 23/16;  
F41C 23/18

See application file for complete search history.

(56) **References Cited**

U.S. PATENT DOCUMENTS

2,529,801	A	11/1950	Fisk
2,545,419	A	3/1951	Williams
3,462,021	A	8/1969	Hawke et al.
3,798,818	A	3/1974	Casull
D259,994	S	7/1981	Salcedo
D276,789	S	12/1984	Olsen
4,751,610	A	6/1988	Nickola
D302,514	S	8/1989	Gates
D339,374	S	9/1993	Chow et al.
D349,230	S	8/1994	Essick
5,375,361	A	12/1994	Rustick
6,499,245	B1	12/2002	Swan

(Continued)

OTHER PUBLICATIONS

Midwest Industries, Inc.—SP Series Handguards, Brownells.com, [online], [site visited Mar. 27, 2018]. <URL: https://www.brownells.com/rifle-parts/forend-amp-handguard-parts/handguards-amp-rails/sp-series-handguard-9-25-m-lok-sku100019318> (Year: 2018).\*

(Continued)

*Primary Examiner* — T Chase Nelson

*Assistant Examiner* — Jonathan J. Han

(74) *Attorney, Agent, or Firm* — Boyle Fredrickson S.C.

(57) **CLAIM**

The ornamental design for a firearm hand guard, substantially as shown and described.

**DESCRIPTION**

FIG. 1 front lower right side perspective view of a firearm hand guard according to the present invention;

FIG. 2 is a right side elevation view of the firearm hand guard shown in FIG. 1;

FIG. 3 is a left side elevation view of the firearm hand guard shown in FIG. 1;

FIG. 4 is a bottom plan view of the firearm hand guard shown in FIG. 1;

FIG. 5 is a top plan view of the firearm hand guard shown in FIG. 1;

FIG. 6 is a rear elevation view of the firearm hand guard shown in FIG. 1; and,

FIG. 7 is a front elevation view of the firearm hand guard shown in FIG. 1.

The broken lines are for illustrative purposes and represent environmental structure and unclaimed portions of the invention and therefor form no part of the claimed design. The dash-dot lines are for illustrating boundaries of the claimed portions of the invention and form no part of the claimed design.

**1 Claim, 6 Drawing Sheets**

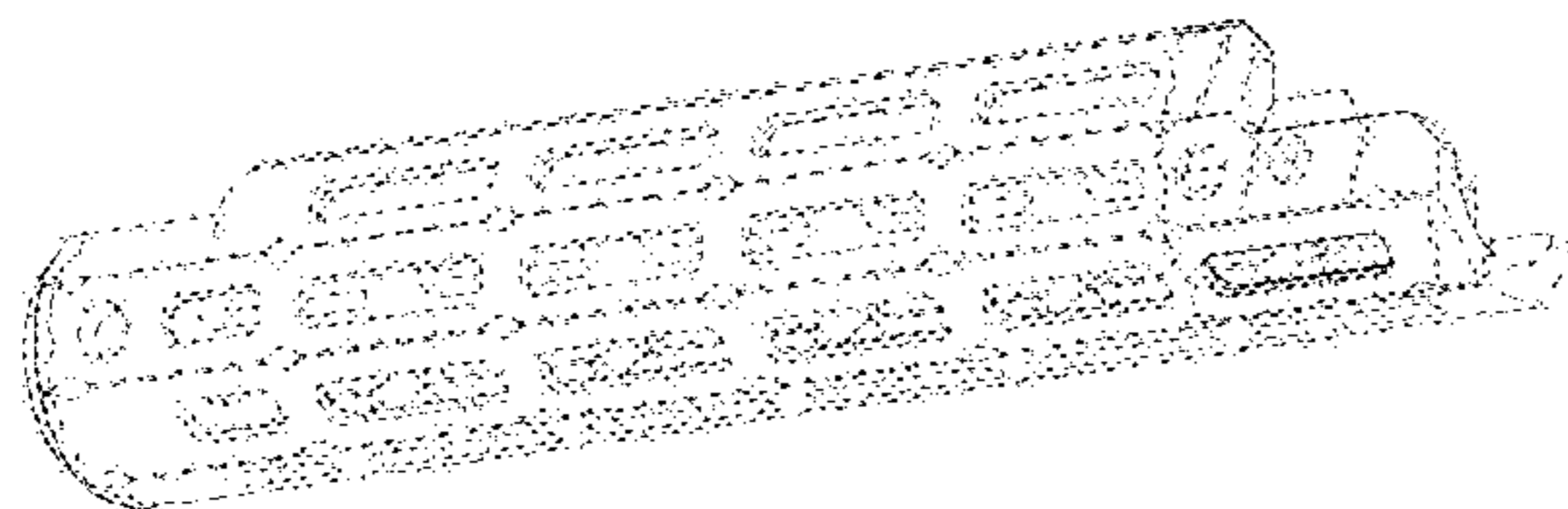

(56)

References Cited

U.S. PATENT DOCUMENTS

D508,726 S 8/2005 Storch  
 7,066,059 B1 6/2006 Hsieh  
 7,096,620 B2 8/2006 Zeh  
 7,191,557 B2 3/2007 Gablowski et al.  
 7,219,370 B1 5/2007 Teetzel  
 D556,290 S 11/2007 Swan  
 7,444,776 B2 11/2008 Adams  
 7,552,558 B1 6/2009 Ballard  
 7,707,762 B1 5/2010 Swan  
 7,802,392 B2 9/2010 Peterson et al.  
 D625,765 S 10/2010 Storch  
 7,836,625 B2 11/2010 Swan et al.  
 D657,013 S 4/2012 Swan  
 D659,220 S 5/2012 Foltz  
 8,201,353 B1 6/2012 Swan  
 8,215,046 B2 7/2012 Chvala  
 D666,689 S 9/2012 Swan  
 D670,352 S 11/2012 Norberg et al.  
 D672,422 S 12/2012 Swan  
 D677,048 S 3/2013 Du  
 8,424,234 B2 4/2013 Carlson  
 D683,807 S 6/2013 Elkaim  
 8,468,733 B2 6/2013 Deros  
 8,510,983 B2 8/2013 Larue  
 8,650,794 B2 2/2014 Swan et al.  
 8,752,320 B2 6/2014 Masters  
 D709,582 S \* 7/2014 Geissele ..... D22/108  
 8,769,854 B1 7/2014 Battaglia  
 8,793,921 B1 8/2014 Tonello  
 8,806,792 B2 8/2014 Yan et al.  
 8,819,980 B2 9/2014 Geissele  
 D720,421 S \* 12/2014 Chen ..... D22/108  
 D721,407 S \* 1/2015 Chu ..... D21/574  
 D724,171 S \* 3/2015 Trusty ..... D22/108  
 D732,378 S 6/2015 Oquendo et al.  
 D733,246 S \* 6/2015 Wells ..... D22/108  
 9,068,801 B1 6/2015 Stecher et al.  
 9,091,505 B1 7/2015 Battaglia  
 D737,397 S \* 8/2015 Cheng ..... D22/108  
 9,157,696 B2 10/2015 Dextraze  
 D744,459 S 12/2015 Cummings  
 9,222,756 B1 12/2015 Battaglia et al.  
 D747,426 S \* 1/2016 Cheng ..... D22/108  
 D747,428 S \* 1/2016 Chen ..... D22/108  
 9,239,209 B2 1/2016 Mayberry et al.  
 9,239,210 B2 1/2016 Mayberry et al.  
 D752,171 S \* 3/2016 Chen ..... D22/108  
 9,297,609 B2 3/2016 Burt  
 D753,256 S 4/2016 Azhocar  
 9,335,117 B2 \* 5/2016 Miller ..... F16B 39/04  
 9,341,441 B2 5/2016 Chang et al.  
 9,341,442 B1 \* 5/2016 Geissele ..... F41C 27/18  
 9,377,274 B2 6/2016 Kincel  
 9,404,714 B2 8/2016 Langevin et al.  
 9,417,034 B1 8/2016 Swan  
 D770,590 S \* 11/2016 Sui ..... D22/108  
 D771,216 S \* 11/2016 Dubois ..... D22/108  
 9,557,137 B2 \* 1/2017 Dzwil ..... F41C 23/16

D779,013 S \* 2/2017 Cheng ..... D22/106  
 9,574,852 B1 \* 2/2017 McKillips ..... F41G 11/003  
 9,599,439 B1 \* 3/2017 Sylvester ..... F41G 11/003  
 D783,760 S \* 4/2017 Pavlick ..... D22/108  
 D783,761 S \* 4/2017 Pavlick ..... D22/108  
 9,625,233 B2 \* 4/2017 Daniel ..... F41C 23/16  
 D785,743 S \* 5/2017 Pavlick ..... D22/108  
 9,664,476 B1 \* 5/2017 Robinson ..... F41C 23/04  
 9,664,478 B2 \* 5/2017 Robinson ..... F41C 23/14  
 9,664,479 B1 \* 5/2017 Robinson ..... F41C 23/14  
 9,702,652 B1 \* 7/2017 Jackson ..... F41A 21/482  
 D795,986 S \* 8/2017 Frederickson ..... D22/108  
 9,791,239 B1 \* 10/2017 Kincel ..... F41C 23/16  
 9,829,272 B2 \* 11/2017 Brown ..... F41C 23/04  
 9,851,083 B2 \* 12/2017 Pinilla ..... F21V 23/0414  
 2004/0000083 A1 1/2004 Grant, Jr.  
 2005/0217161 A1 10/2005 Haugen et al.  
 2006/0053673 A1 3/2006 Murello  
 2006/0174733 A1 6/2006 Hsieh  
 2008/0092422 A1 4/2008 Daniel  
 2009/0038198 A1 2/2009 Yu  
 2009/0126538 A1 5/2009 Miers  
 2010/0186582 A1 \* 7/2010 Juarez ..... F41A 5/28  
 89/191.01  
 2010/0319231 A1 \* 12/2010 Stone ..... F41C 23/16  
 42/71.01  
 2011/0061281 A1 \* 3/2011 Kapusta ..... F41C 23/16  
 42/71.01  
 2012/0167434 A1 7/2012 Masters  
 2012/0169000 A1 7/2012 Lin et al.  
 2013/0074394 A1 3/2013 Larue  
 2013/0219765 A1 8/2013 Ibaruren  
 2013/0288743 A1 10/2013 Hunt  
 2014/0041273 A1 2/2014 Masters  
 2014/0130390 A1 5/2014 Geissele  
 2014/0373419 A1 12/2014 Leclair  
 2015/0007476 A1 \* 1/2015 Dextraze ..... F41G 11/003  
 42/71.01  
 2015/0020429 A1 1/2015 Savoy  
 2015/0343627 A1 12/2015 Hensley  
 2015/0369555 A1 12/2015 Daniel  
 2016/0223286 A1 8/2016 Storch  
 2017/0059273 A1 \* 3/2017 Geissele ..... F41C 23/16  
 2017/0307321 A1 \* 10/2017 DeSomma ..... F41A 21/10

OTHER PUBLICATIONS

Aim Sports AR-15 Free Float M-LOK Handguard, SportsmansGuide.com, [online], [site visited Mar. 27, 2018]. <URL: <https://www.sportsmansguide.com/product/index/aim-sports-ar-15-free-float-m-lok-handguard>> (Year: 2018).\*

F4 Defense ARS-Lite Handguard—15.5", RainierArms.com, [online], [site visited Mar. 27, 2018]. <URL: <https://www.rainierarms.com/f4-defense-ars-lite-handguard-15-5/>> (Year: 2018).\*

MI G3 M-Series One Piece Free Float Handguard, MidwestIndustries.com, [online], [site visited Mar. 27, 2018]. <URL: <https://www.midwestindustriesinc.com/product-p/mi-g3m9-blk.htm>> (Year: 2018).\*

\* cited by examiner

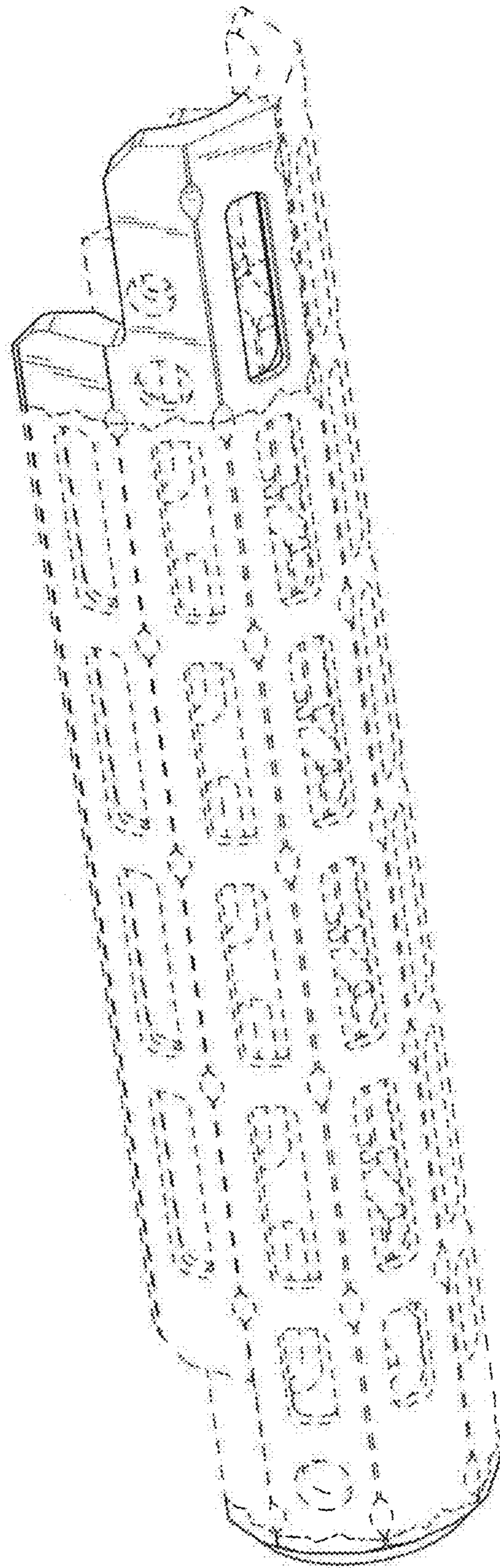

FIG. 1

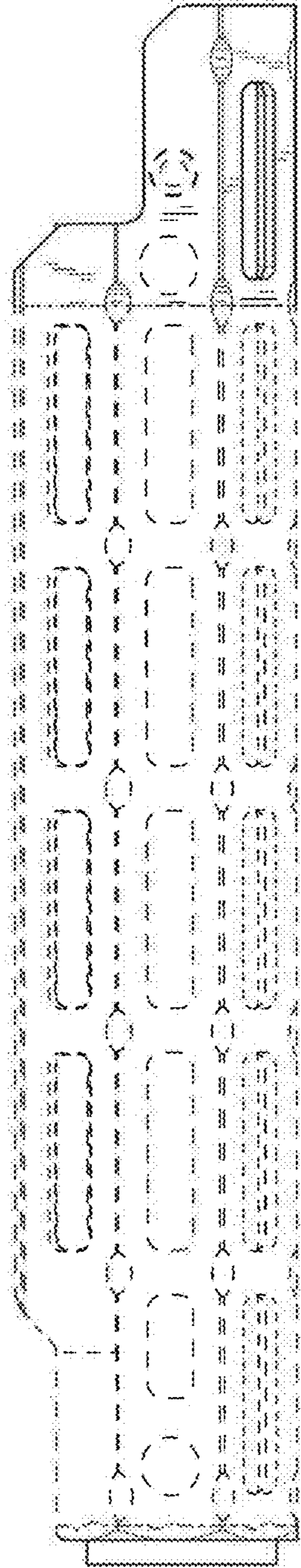

FIG. 2

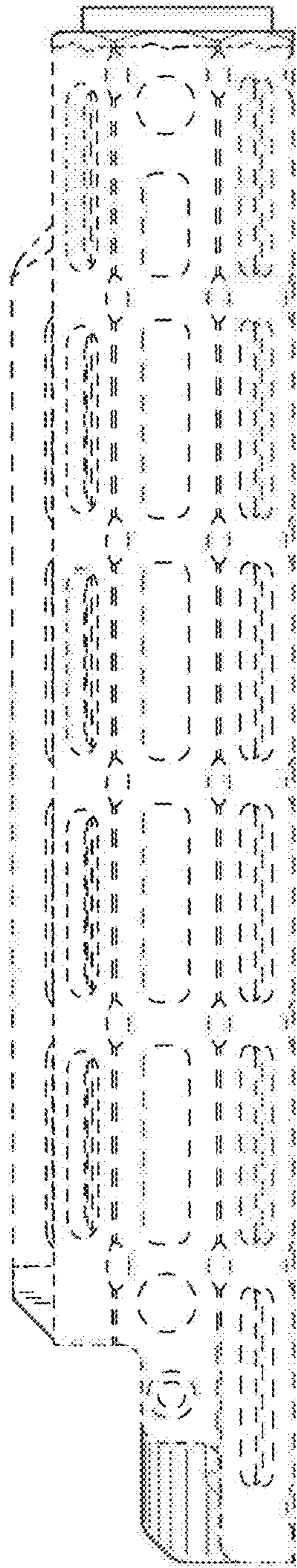

FIG. 3

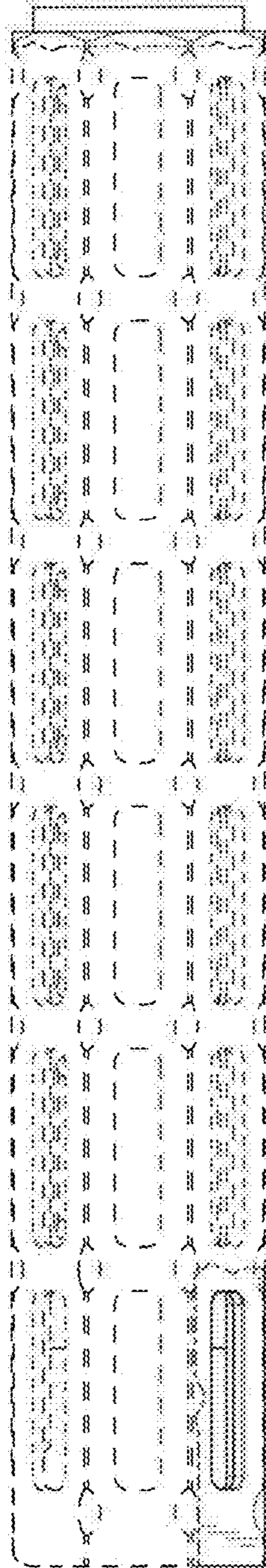

FIG. 4

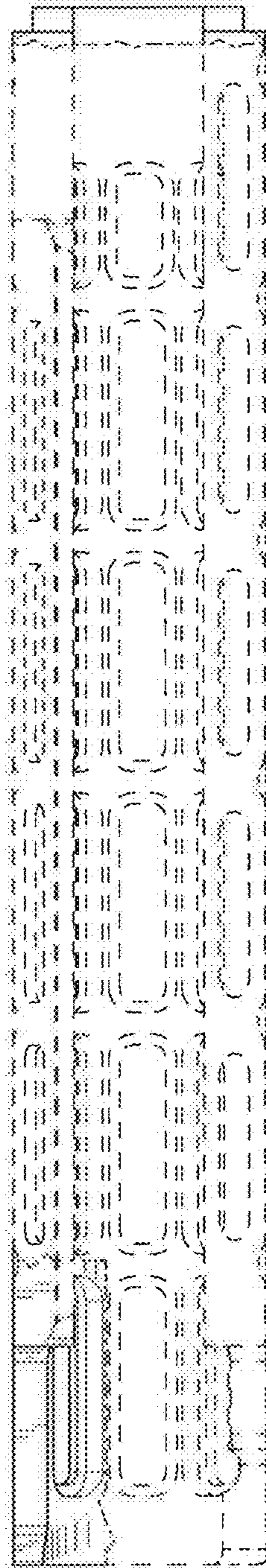

FIG. 5

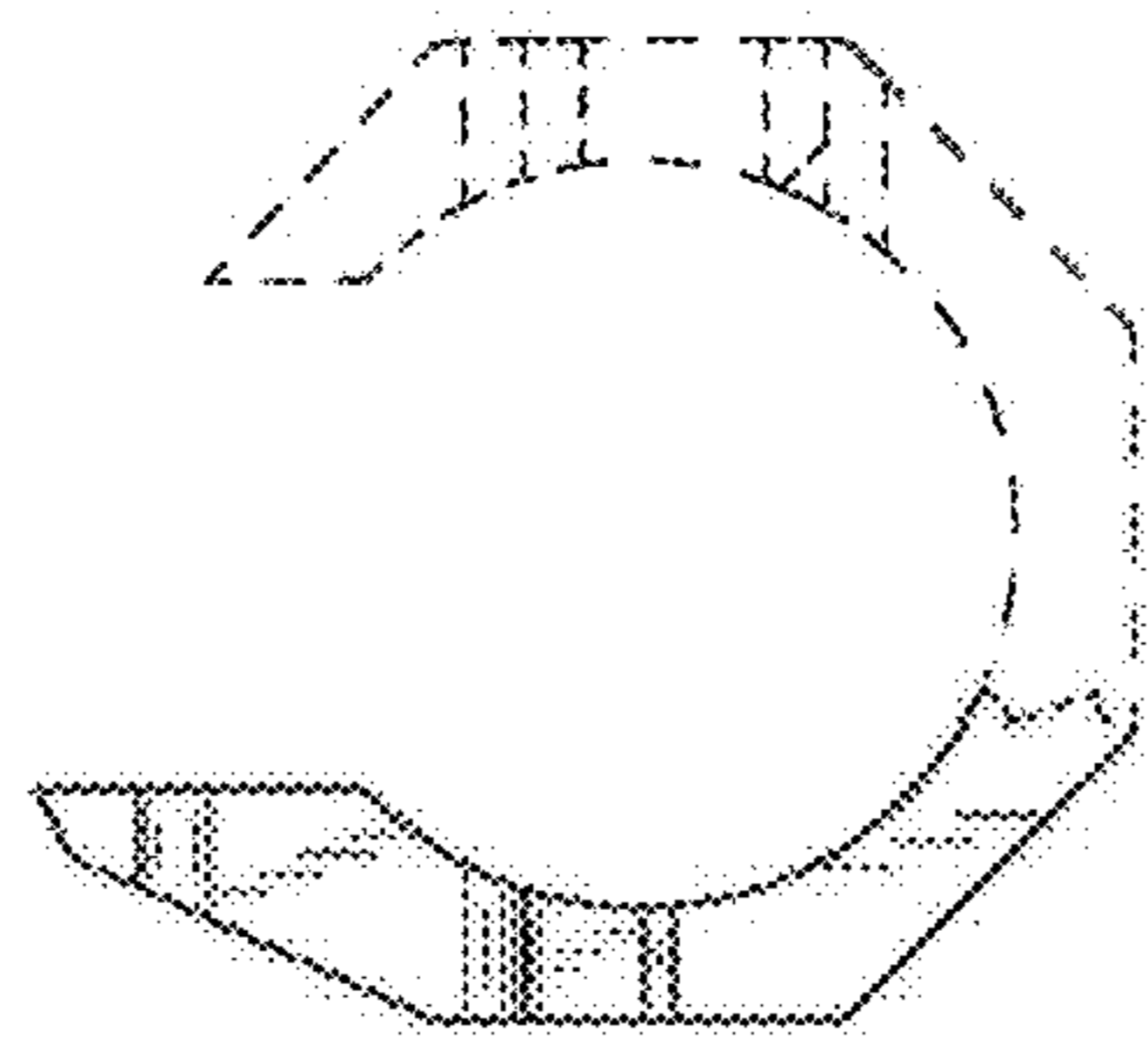

FIG. 7

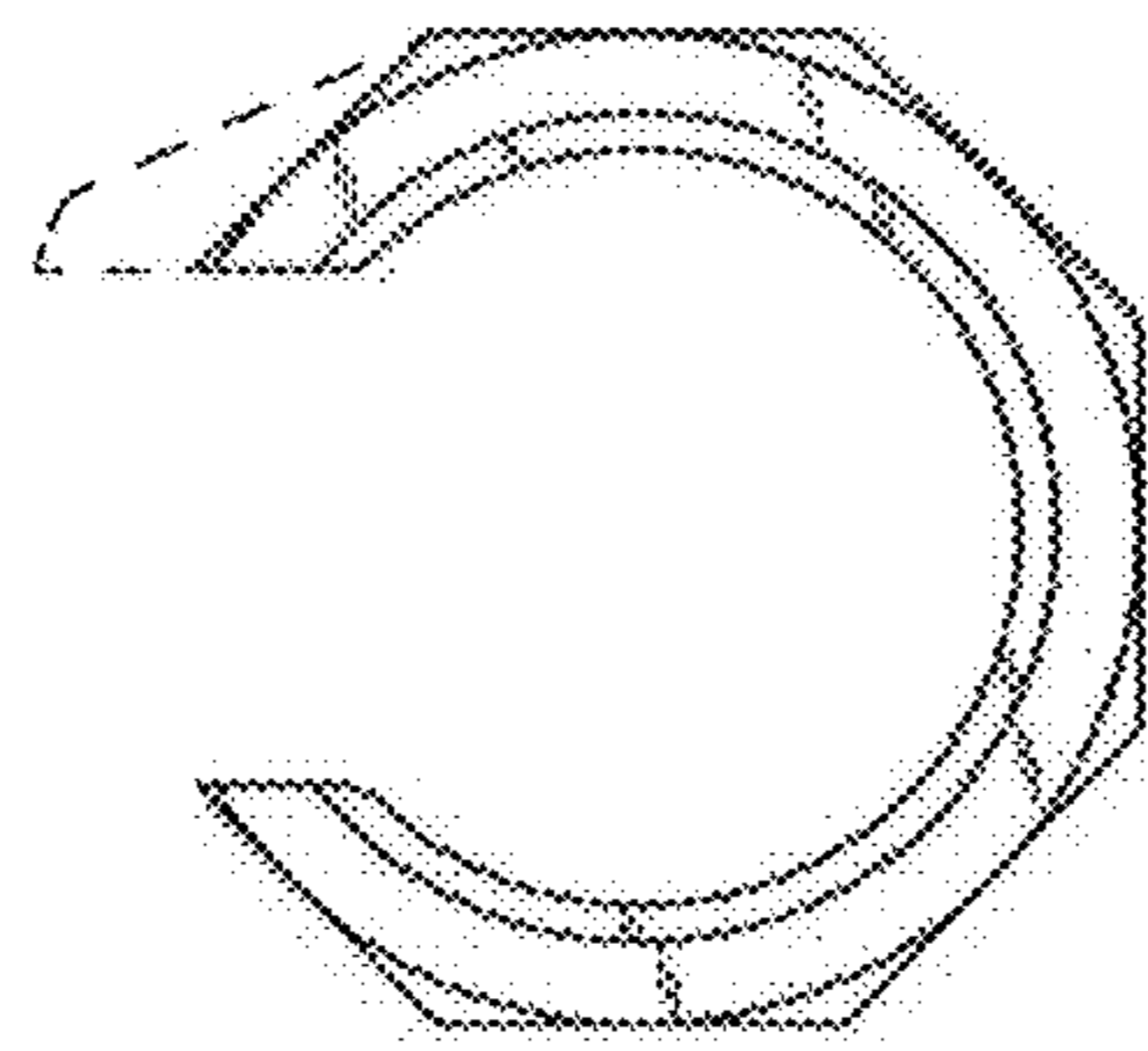

FIG. 6