



US00D840454S

(12) **United States Design Patent** (10) **Patent No.:** **US D840,454 S**  
**Han et al.** (45) **Date of Patent:** **\*\* Feb. 12, 2019**

(54) **HEAD WORN DISPLAY WAVE-GUIDE ASSEMBLY**

(71) Applicant: **Rockwell Collins, Inc.**, Cedar Rapids, IA (US)

(72) Inventors: **David I. Han**, Lake Oswego, OR (US); **Ian M. Meyer**, Milwaukee, OR (US)

(73) Assignee: **Rockwell Collins, Inc.**, Cedar Rapids, IA (US)

(\*\*) Term: **15 Years**

(21) Appl. No.: **29/570,548**

(22) Filed: **Jul. 8, 2016**

(51) **LOC (11) Cl.** ..... **16-99**

(52) **U.S. Cl.**  
USPC ..... **D16/130**

(58) **Field of Classification Search**  
USPC .... D14/372, 496, 432; D16/19, 38, 48, 100, D16/101, 131, 132, 133, 134, 135, 310, D16/140; D26/142  
CPC ..... A42B 3/04; A61B 17/00  
See application file for complete search history.

(56) **References Cited**

**U.S. PATENT DOCUMENTS**

- 3,336,598 A \* 8/1967 Aebersold ..... A42B 3/185 2/10
- D352,046 S \* 11/1994 Kataoka ..... D16/130
- D389,826 S \* 1/1998 Cousins ..... D14/135
- D458,287 S \* 6/2002 Huang ..... D16/135

- D521,493 S \* 5/2006 Wai ..... D14/205
- D711,949 S \* 8/2014 Koenck ..... D16/130
- D732,025 S \* 6/2015 Heinrich ..... D14/372
- D746,818 S \* 1/2016 Cho ..... D14/372
- D749,585 S \* 2/2016 Olsson ..... D14/372
- D788,832 S \* 6/2017 Alles ..... D16/133
- D813,231 S \* 3/2018 Yoshida ..... D14/372

\* cited by examiner

*Primary Examiner* — Mark A Goodwin

*Assistant Examiner* — Benjamin M Weeks

(74) *Attorney, Agent, or Firm* — Angel N. Gerdzhikov; Donna P. Suchy; Daniel M. Barbieri

(57) **CLAIM**

The ornamental design for a head worn display wave-guide assembly, as shown and described.

**DESCRIPTION**

FIG. 1 is a perspective view of a head worn display wave-guide assembly showing our new design, the broken lines indicate environmental structure and form no part of the claimed design;

FIG. 2 is a top plan view thereof;

FIG. 3 is a front elevational view thereof;

FIG. 4 is a left side elevational view thereof;

FIG. 5 is a rear elevational view thereof;

FIG. 6 is a right side elevational view thereof; and,

FIG. 7 is a bottom plan view thereof.

The broken-lines of the figures depict a head worn display as well as related elements and various portions environmentally thereof. These broken line features are depicted for illustrative purposes, and form no part of the claimed design.

**1 Claim, 7 Drawing Sheets**

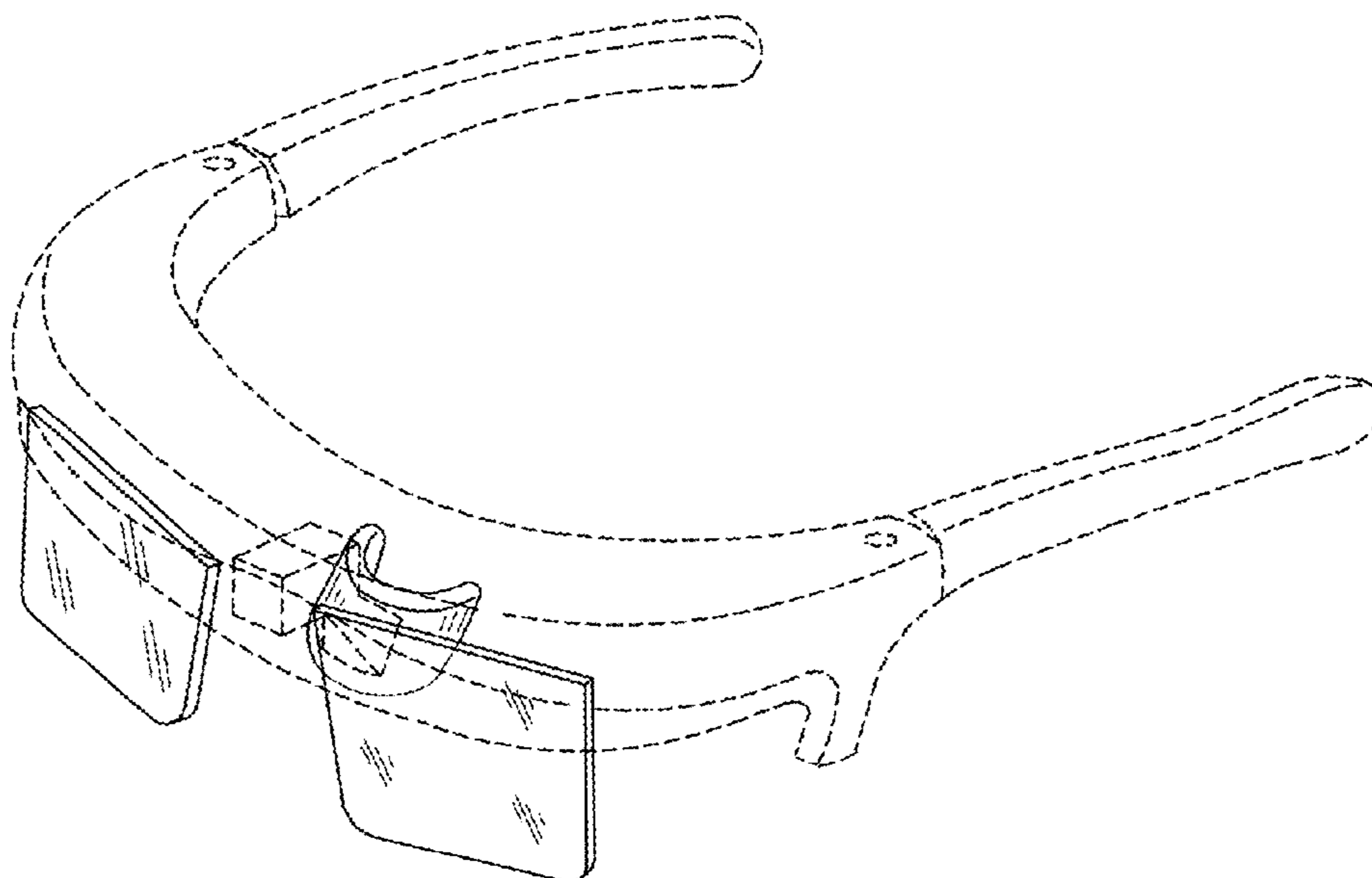

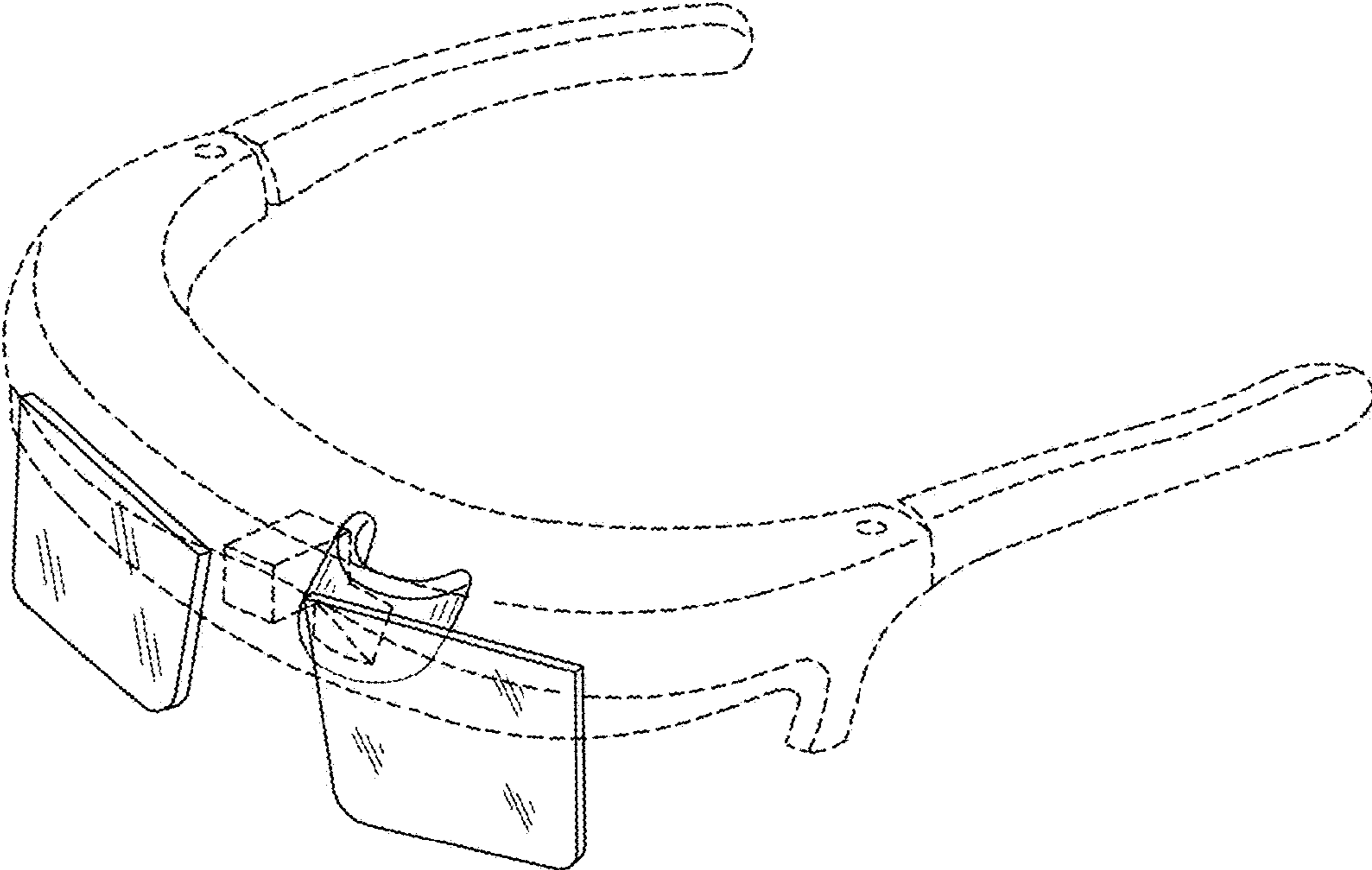

FIG. 1

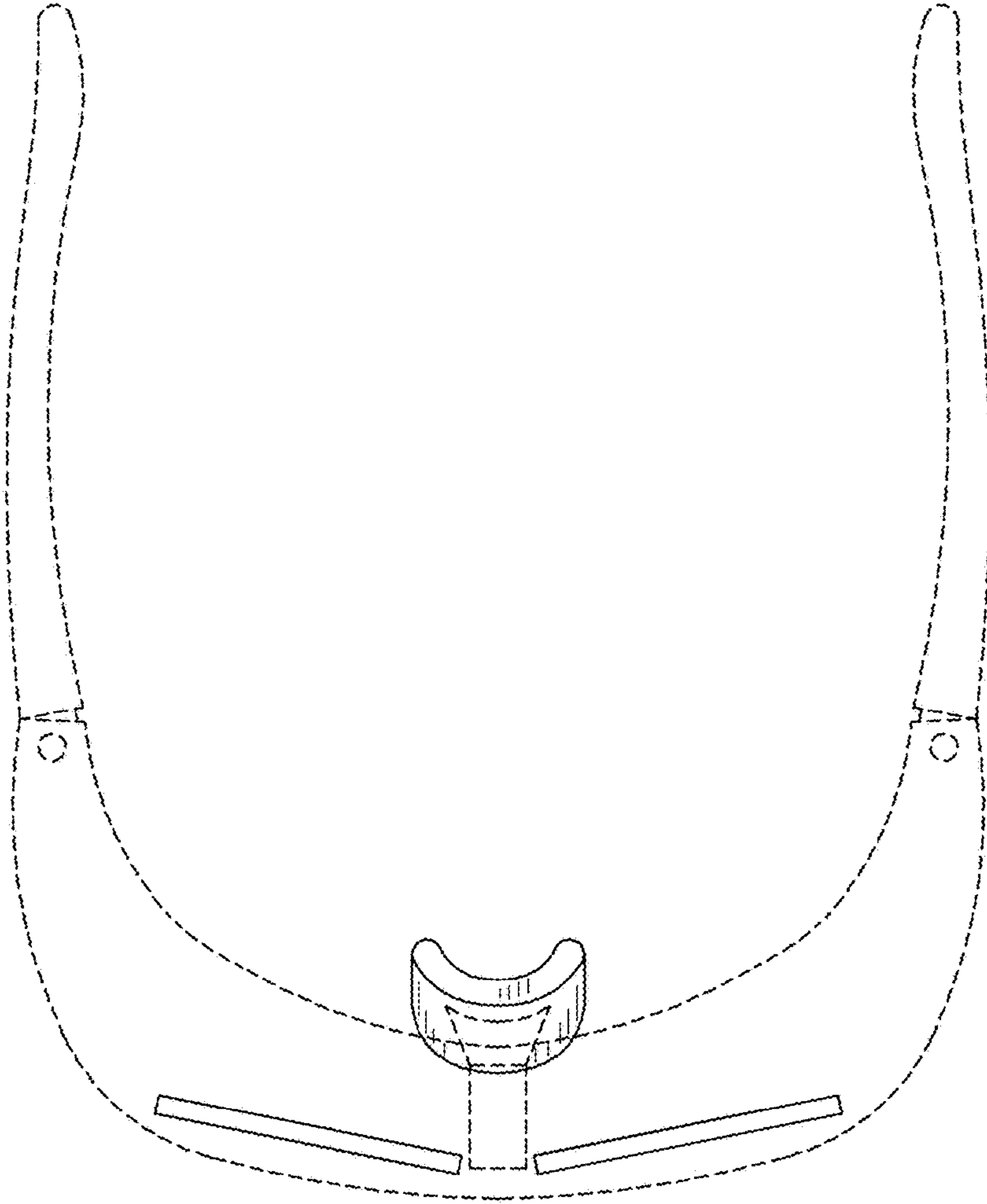

FIG. 2

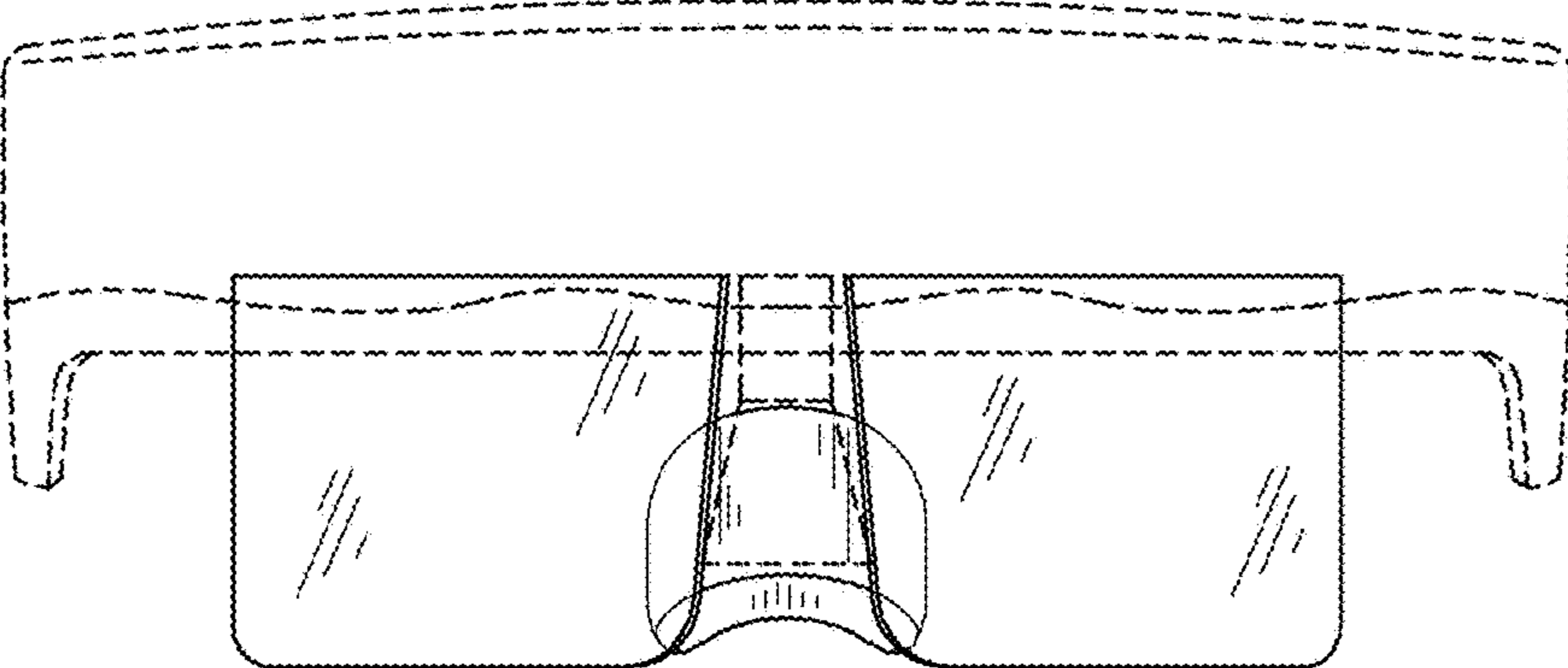

FIG. 3

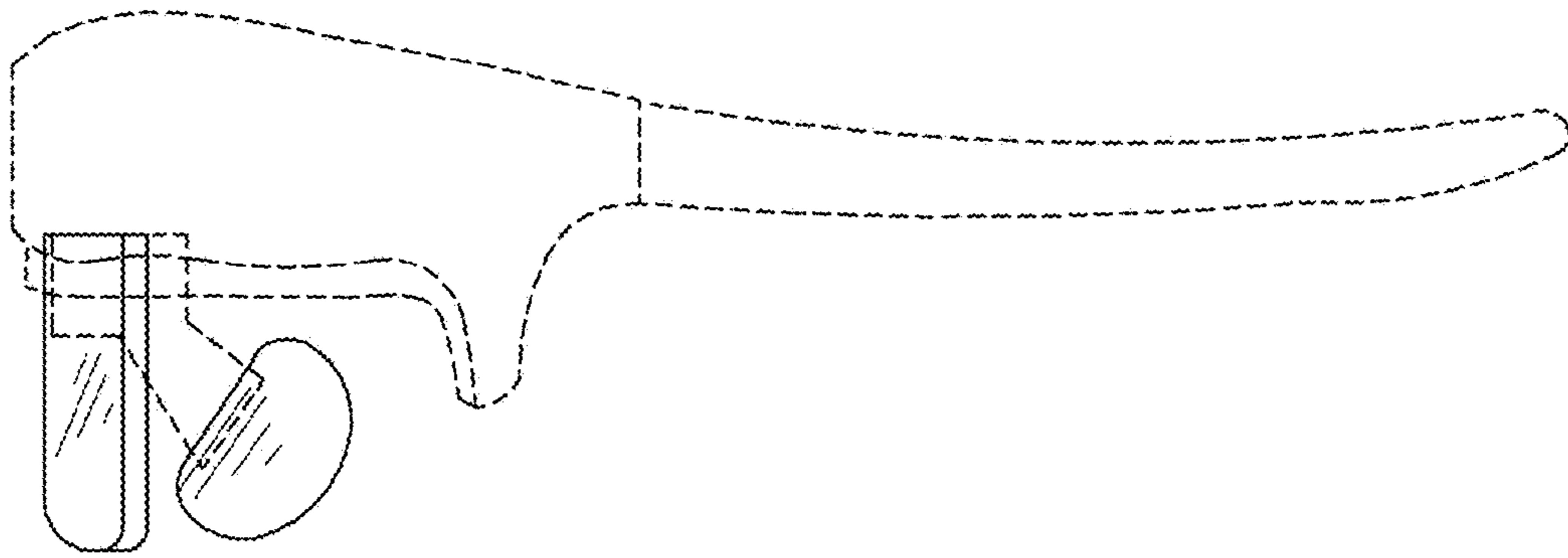

FIG. 4

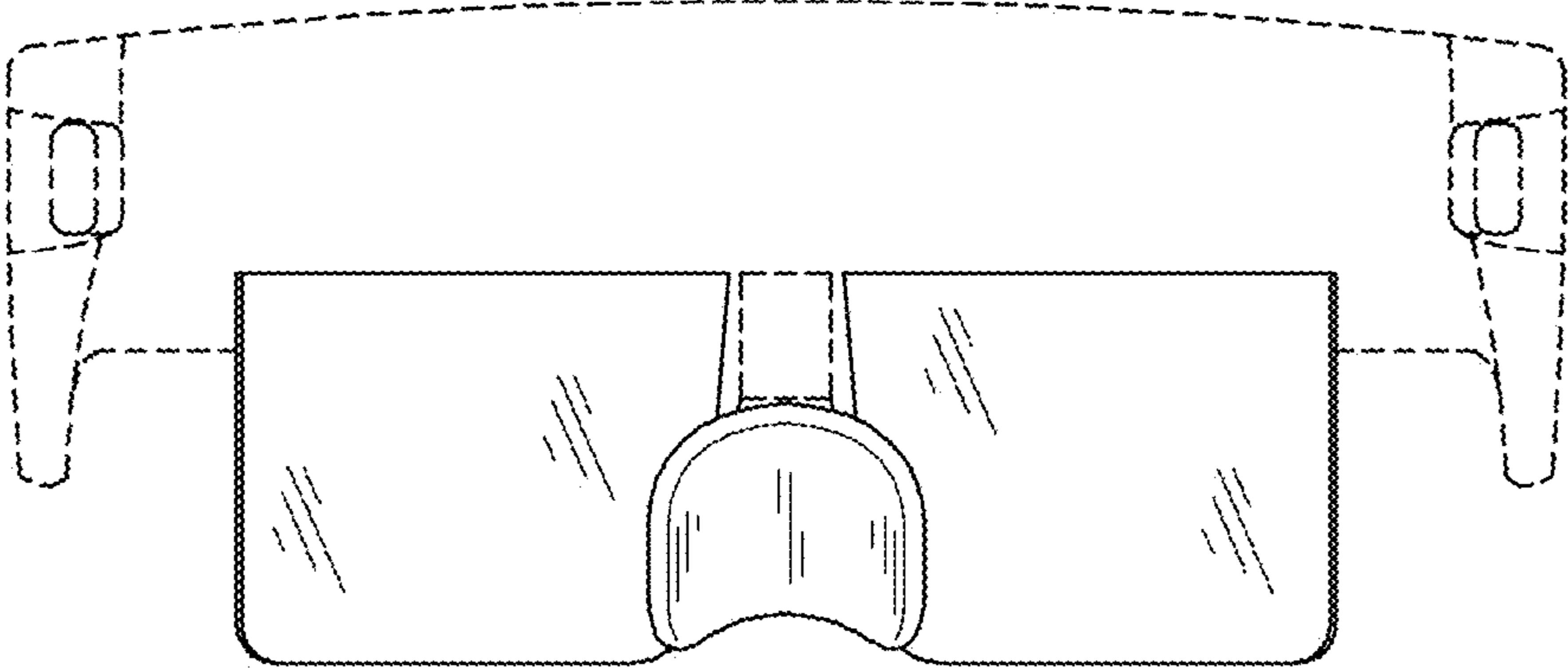

FIG. 5

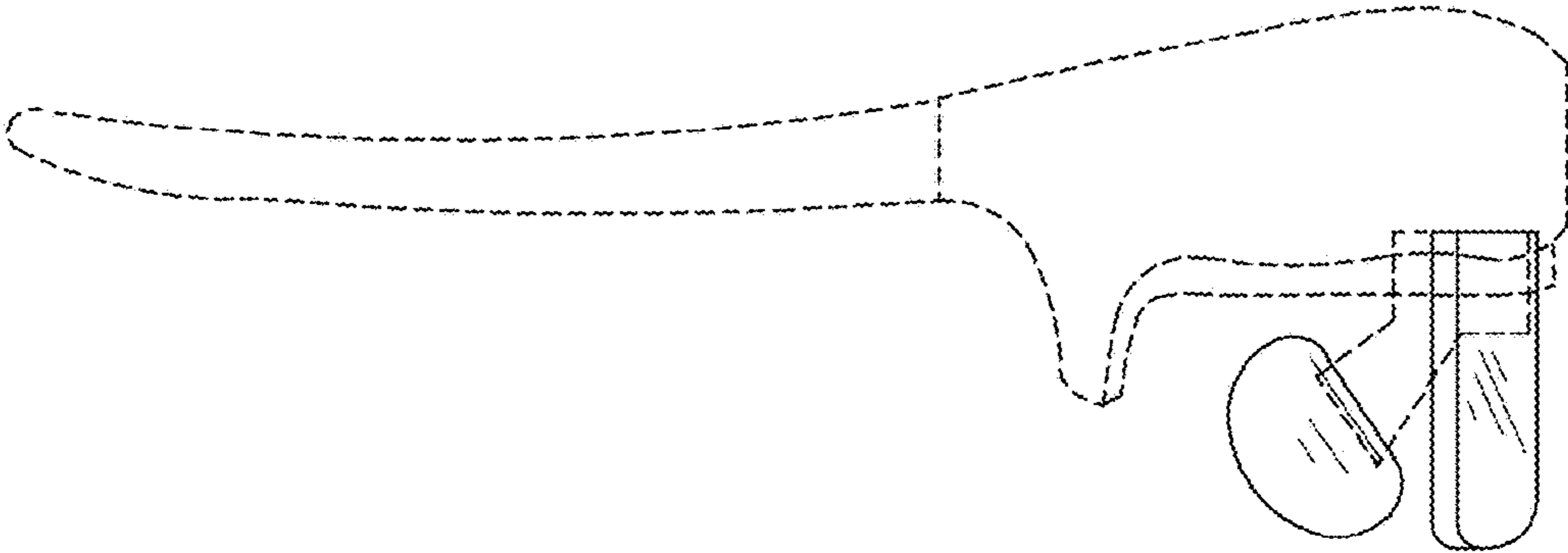

FIG. 6

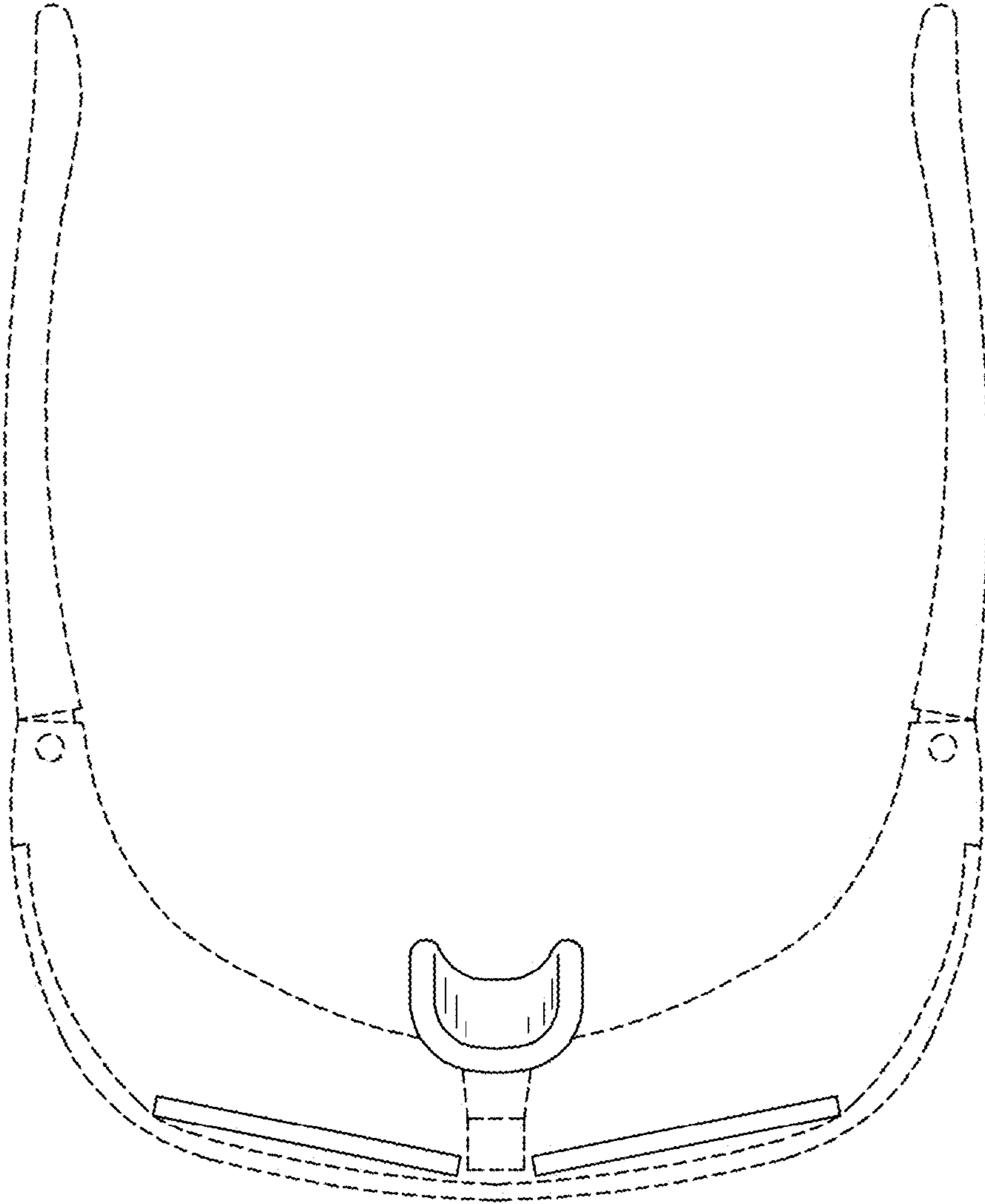

FIG. 7