

US00D840394S

(12) **United States Design Patent**
Son et al.

(10) **Patent No.:** **US D840,394 S**

(45) **Date of Patent:** **** Feb. 12, 2019**

(54) **ELECTRONIC DEVICE**

(71) Applicant: **Samsung Electronics Co., Ltd.**,
Suwon-si (KR)

(72) Inventors: **Hyun-Keun Son**, Seoul (KR);
Jun-Won Lee, Seongnam-si (KR);
Jang-Woon Kim, Seoul (KR);
Chung-Ha Kim, Seoul (KR);
Seung-Ho Jang, Seongnam-si (KR)

(73) Assignee: **Samsung Electronics Co., Ltd.**,
Suwon-si (KR)

(**) Term: **15 Years**

(21) Appl. No.: **29/617,109**

(22) Filed: **Sep. 12, 2017**

(30) **Foreign Application Priority Data**

Mar. 14, 2017 (KR) 30-2017-0011872

(51) **LOC (11) Cl.** **14-02**

(52) **U.S. Cl.**
USPC **D14/345; D14/138 R**

(58) **Field of Classification Search**
USPC D14/341-347, 125-134, 137, 138 R,
D14/138 AA, 138 AB, 138 C, 138 G, 147,
(Continued)

(56) **References Cited**

U.S. PATENT DOCUMENTS

D588,126 S * 3/2009 Chiang D14/345
D601,992 S * 10/2009 Choi D14/138 AB
(Continued)

FOREIGN PATENT DOCUMENTS

EM 002220996-0002 6/2013
EM 002234666-0001 7/2013

OTHER PUBLICATIONS

ZTE Axon M with two displays, a new trend in smartphones?,
posted Oct. 18, 2017, [retrieved Aug. 23, 2018]. Retrieved from

Internet, <URL: <http://dunyanews.tv/en/Technology/410348-ZTE-Axon-M-with-two-displays-could-be-a-new-trend-in-smartphone-industry>>.*

(Continued)

Primary Examiner — Barbara Fox
Assistant Examiner — Kristin E Reed
(74) *Attorney, Agent, or Firm* — NSIP Law

(57) **CLAIM**

We claim the ornamental design for an electronic device, as shown and described.

DESCRIPTION

FIG. 1 is a front perspective view of an electronic device showing our new design;
FIG. 2 is a front elevational view thereof;
FIG. 3 is a rear elevational view thereof;
FIG. 4 is a left-side elevational view thereof;
FIG. 5 is a right-side elevational view thereof;
FIG. 6 is a top plan view thereof;
FIG. 7 is a bottom plan view thereof;
FIG. 8 is another perspective view thereof showing the electronic device in a first partially open position;
FIG. 9 is a front elevational view thereof;
FIG. 10 is a rear elevational view thereof;
FIG. 11 is a left-side elevational view thereof;
FIG. 12 is a right-side elevational view thereof;
FIG. 13 is a top plan view thereof;
FIG. 14 is a bottom plan view thereof;
FIG. 15 is another perspective view thereof showing the electronic device in a second partially open position;
FIG. 16 is a front elevational view thereof;
FIG. 17 is a rear elevational view thereof;
FIG. 18 is a left-side elevational view thereof;
FIG. 19 is a right-side elevational view thereof;
FIG. 20 is a top plan view thereof;
FIG. 21 is a bottom plan view thereof;
FIG. 22 is another perspective view thereof showing the electronic device in a third partially open position;
FIG. 23 is a front elevational view thereof;
FIG. 24 is a rear elevational view thereof;
FIG. 25 is a left-side elevational view thereof;

(Continued)

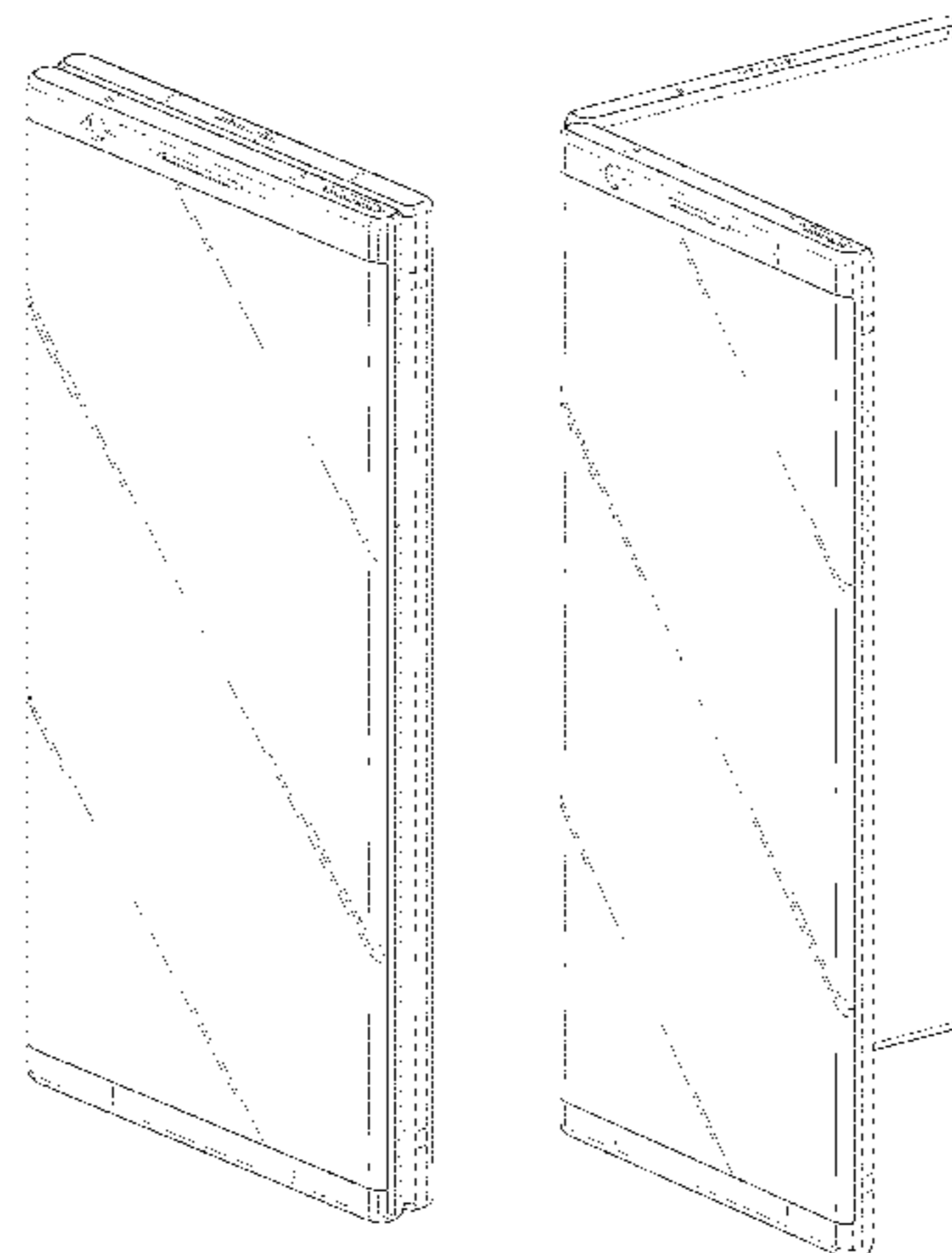

FIG. 26 is a right-side elevational view thereof;
 FIG. 27 is a top plan view thereof;
 FIG. 28 is a bottom plan view thereof;
 FIG. 29 is another perspective view thereof showing the electronic device in an open position;
 FIG. 30 is a front elevational view thereof;
 FIG. 31 is a rear elevational view thereof;
 FIG. 32 is a left-side elevational view thereof;
 FIG. 33 is a right-side elevational view thereof;
 FIG. 34 is a top plan view thereof;
 FIG. 35 is a bottom plan view thereof; and,
 FIG. 36 is an enlarged view of the encircled portion in FIG. 6.

The evenly dashed broken lines in the figures show portions of the electronic device which form no part of the claimed design.

The dot-dashed broken lines encircling portions of the claimed design that are illustrated in enlargements form no part of the claimed design.

1 Claim, 34 Drawing Sheets

(58) **Field of Classification Search**

USPC ... D14/203.1, 203.3, 203.4, 203.7, 218, 247, D14/248, 332, 336, 371, 374-377, 388, D14/389, 315-318, 420, 426, 429, 440, D14/448, 450, 489, 492, 496; D6/300-310; D10/50, 65, 98, 104.1; D16/241; D18/4.6, 6; D20/10, 19, 39; D21/329, 330

CPC . A63H 33/3016; G06F 1/1613; G06F 1/1641; G06F 1/1643; G06F 1/1647; G06F 3/04883; G06F 3/0486; G06F 3/04847; G06F 3/04845; G06F 3/0484; G06F 3/04817; H05K 5/0004; H05K 5/0017; H05K 5/02; H05K 5/0217; H04M 1/0279; H04M 1/0281; H04M 1/0283; H04N 13/0459

See application file for complete search history.

(56)

References Cited

U.S. PATENT DOCUMENTS

D680,527	S	*	4/2013	Reeves	D14/341
D714,244	S	*	9/2014	Lee	D14/138 AB
D716,750	S	*	11/2014	Matsumoto	D14/138 AB
D719,540	S	*	12/2014	Lee	D14/138 AB
D739,402	S	*	9/2015	Seoc	D14/341
D746,285	S	*	12/2015	Okabe	D14/345
D749,571	S	*	2/2016	Park	D14/203.4
D769,209	S	*	10/2016	Byun	D14/138 AB
D772,225	S		11/2016	Kacin et al.		
9,489,080	B2	*	11/2016	Seo	G06F 1/1641
D775,598	S	*	1/2017	Kim	D14/138 AB
D810,073	S	*	2/2018	Bae	D14/341
D825,513	S	*	8/2018	Seo	D14/138 AB

OTHER PUBLICATIONS

Samsung Galaxy X Foldable Smartphone Gets 3D Trailer, posted Mar. 22, 2017, [retrieved Aug. 23, 2018]. Retrieved from Internet, <URL: <https://www.concept-phones.com/samsung/samsung-galaxy-foldable-smartphone-3d-trailer-video/> >.*

* cited by examiner

FIG. 1

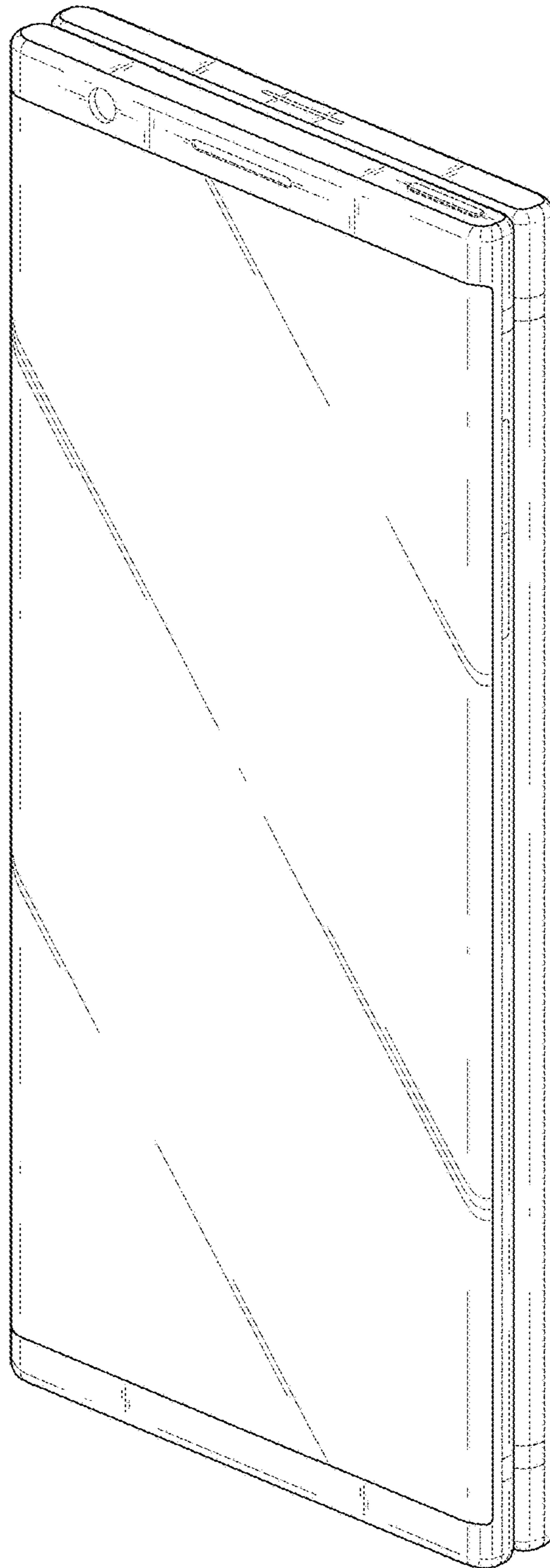

FIG. 2

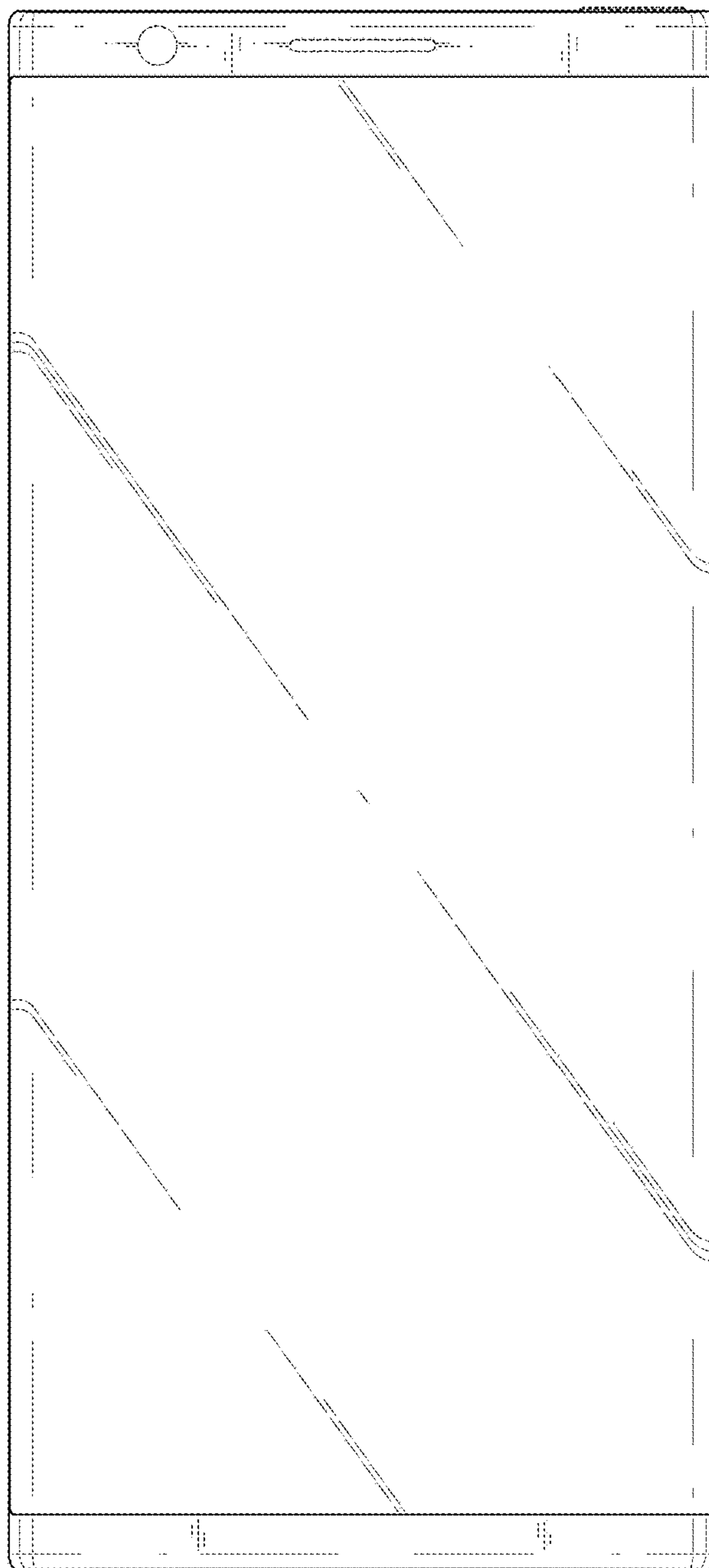

FIG. 3

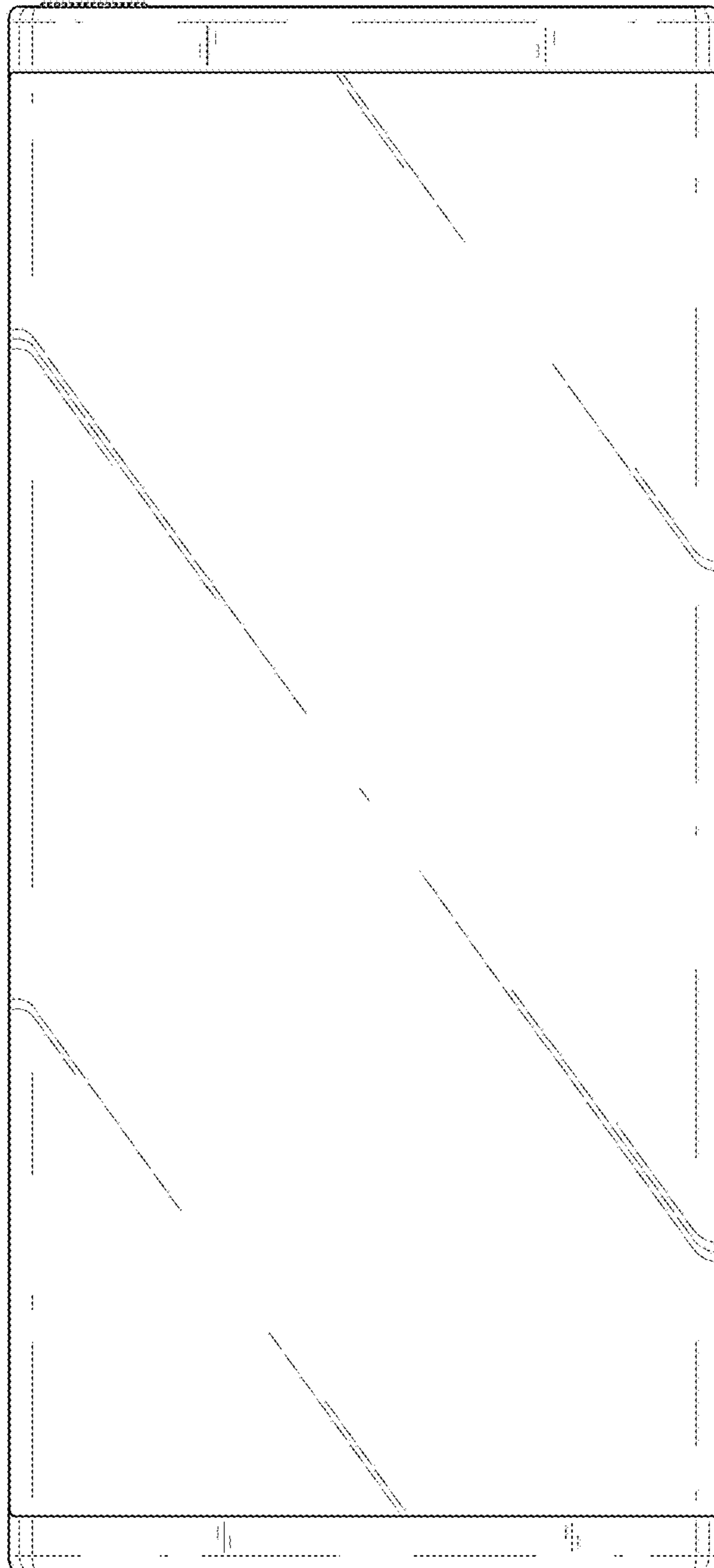

FIG. 4

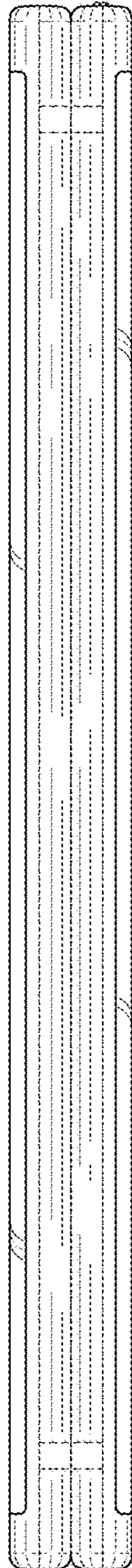

FIG. 5

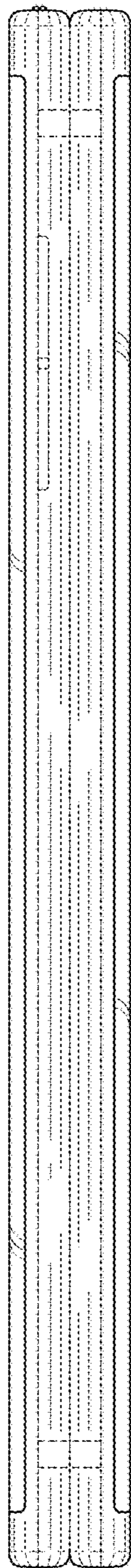

FIG. 6

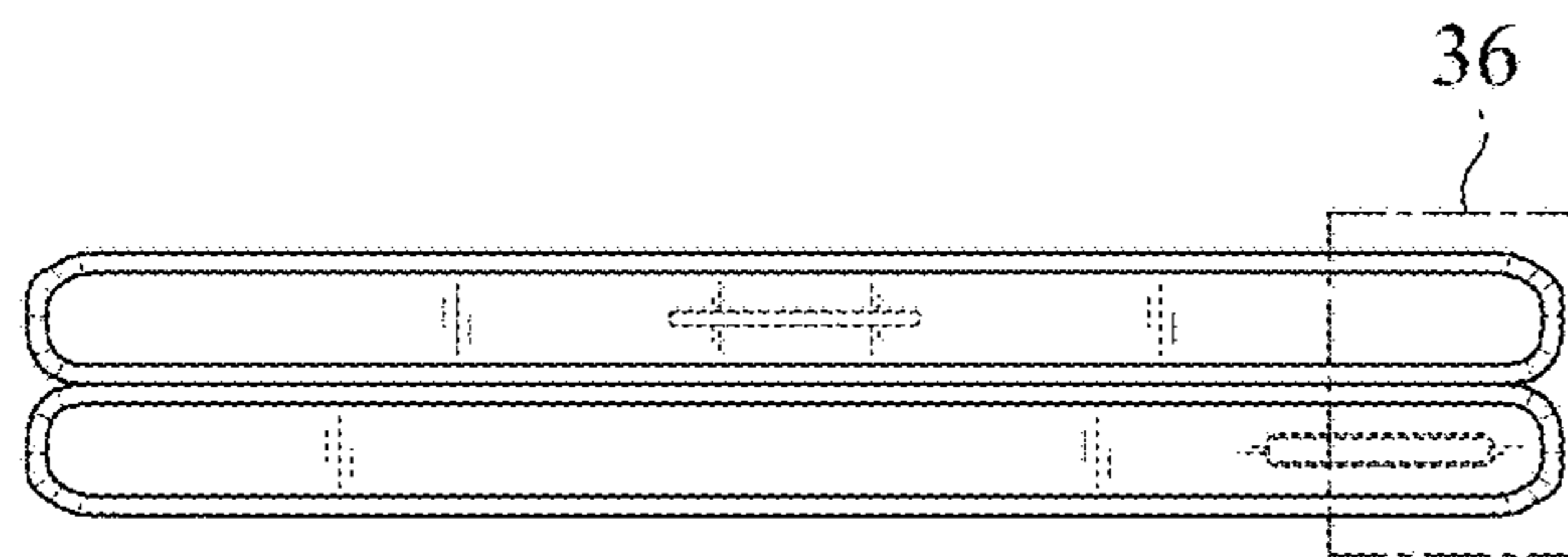

FIG. 7

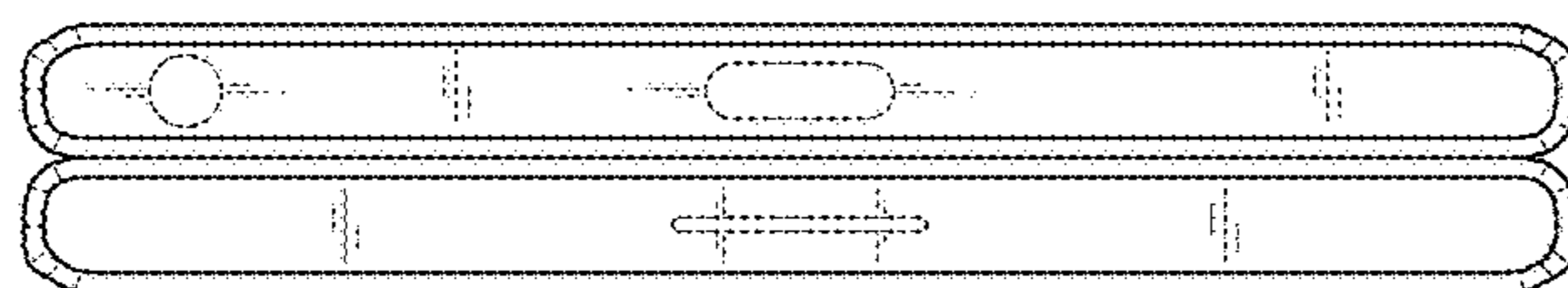

FIG. 8

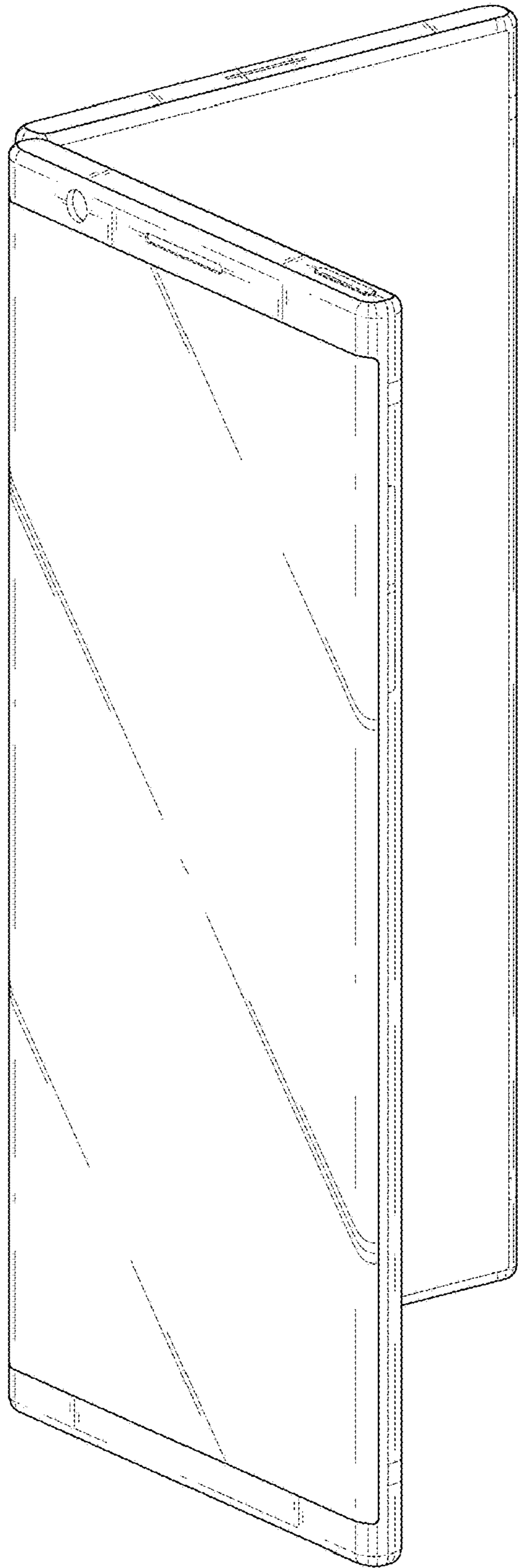

FIG. 9

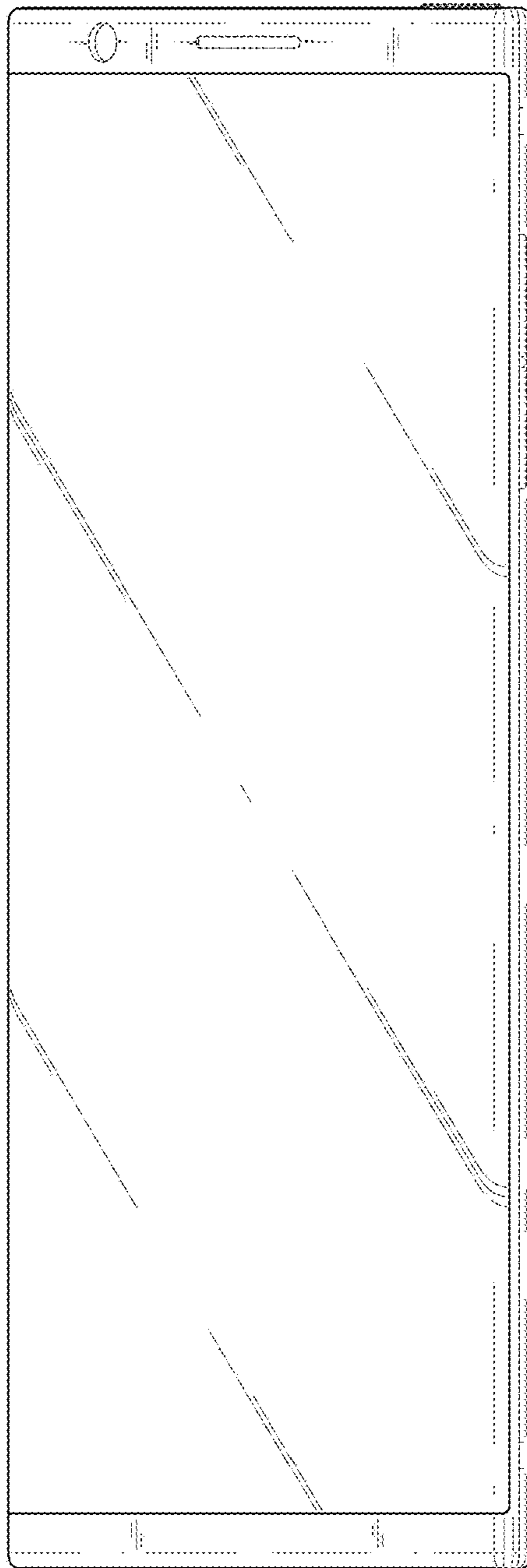

FIG. 10

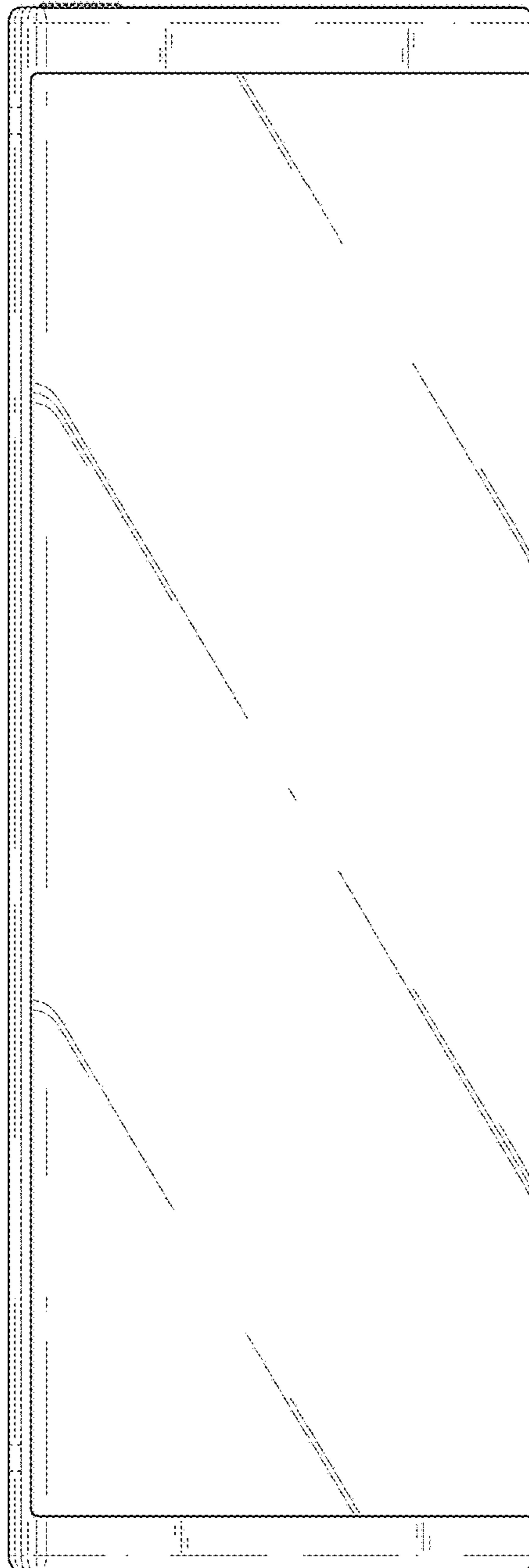

FIG. 11

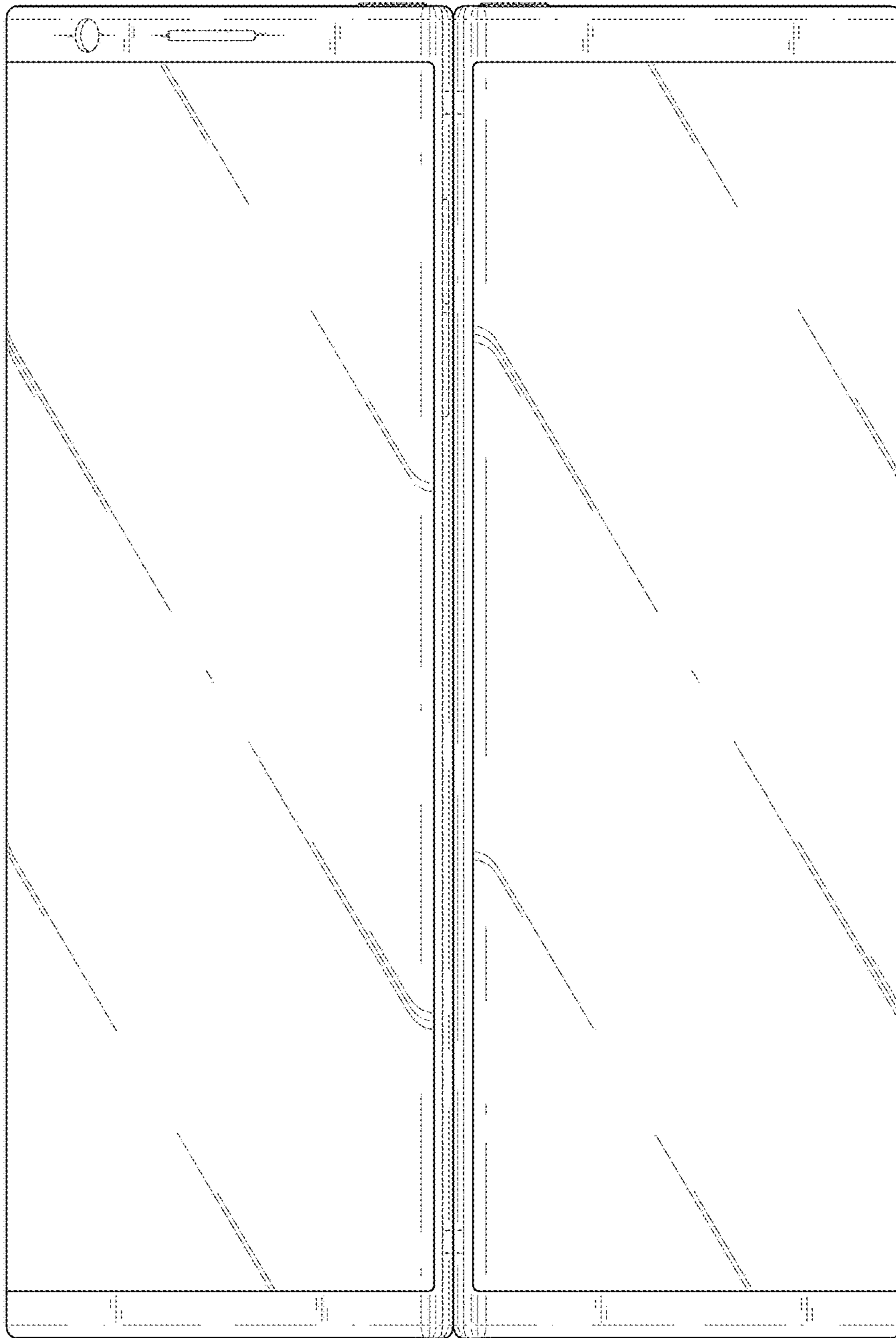

FIG. 12

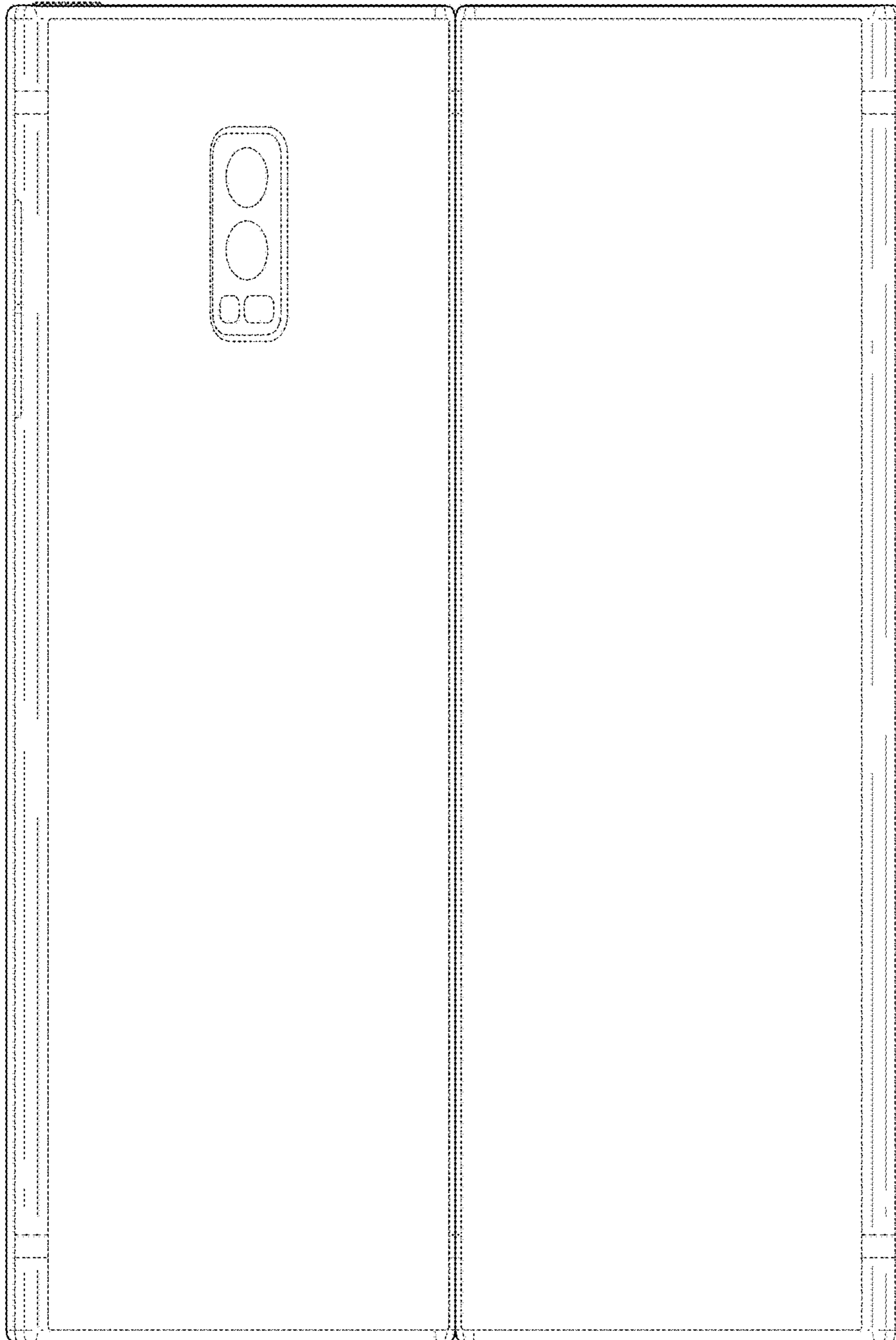

FIG. 13

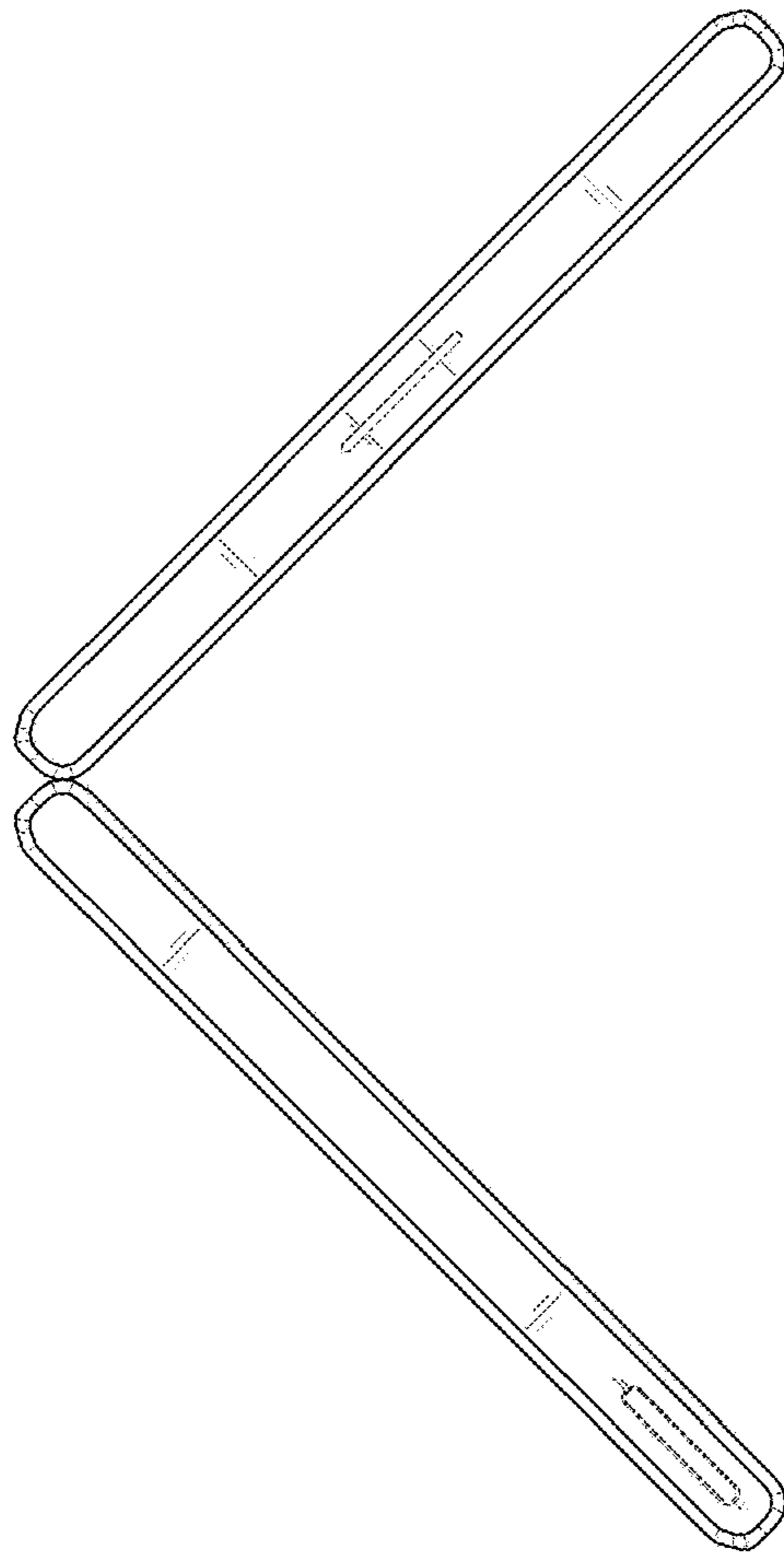

FIG. 14

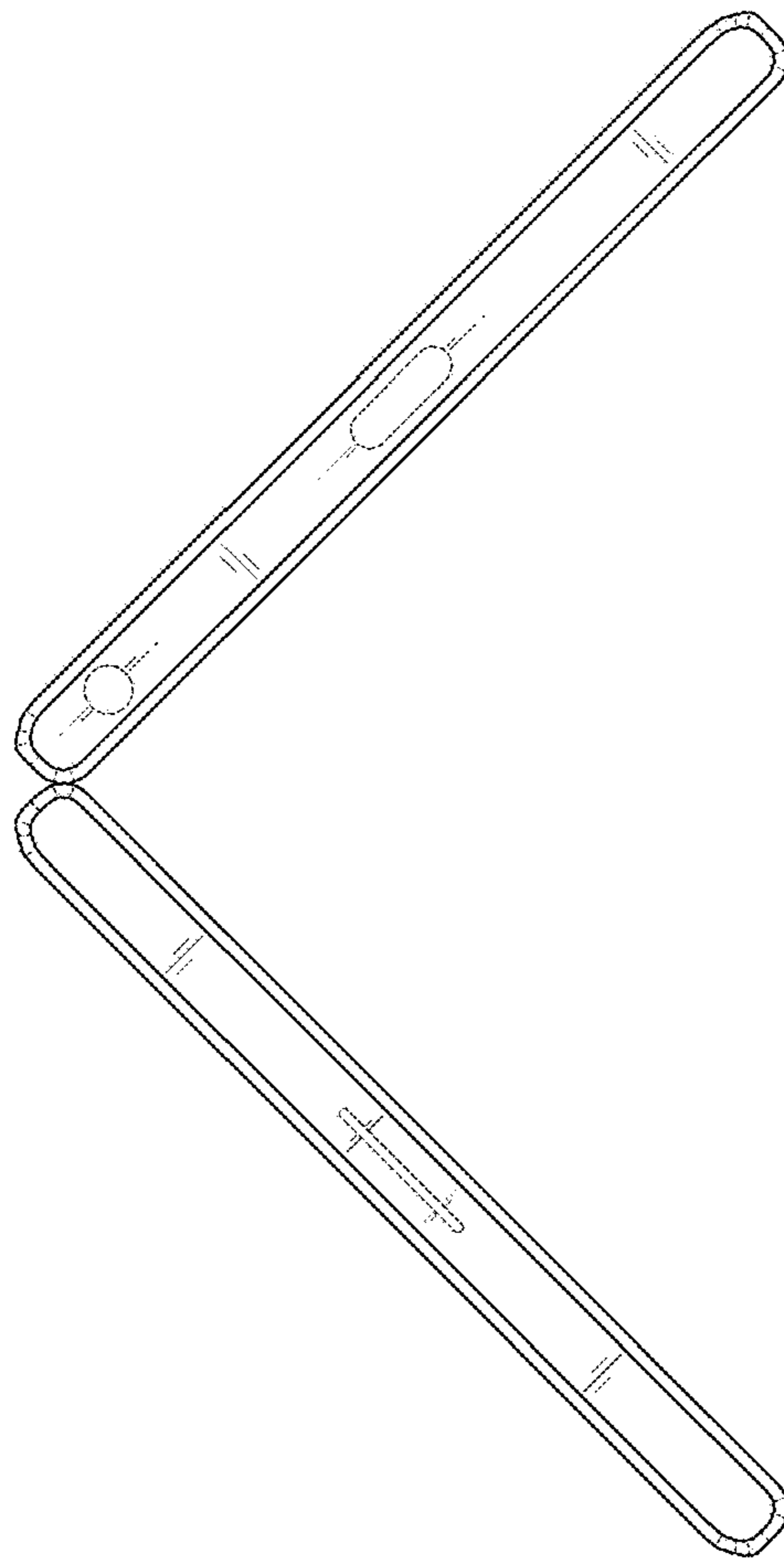

FIG. 15

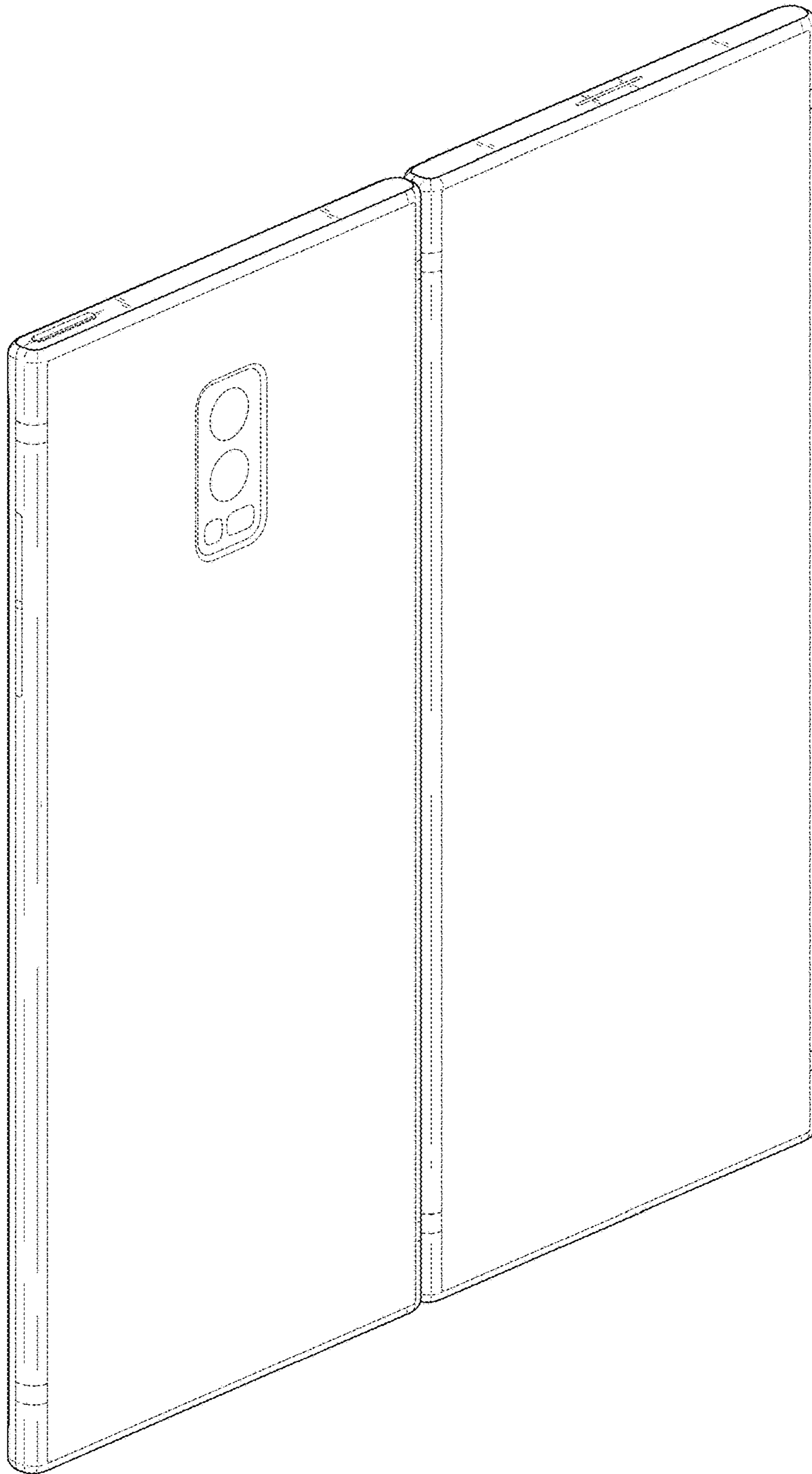

FIG. 16



FIG. 17



FIG. 18

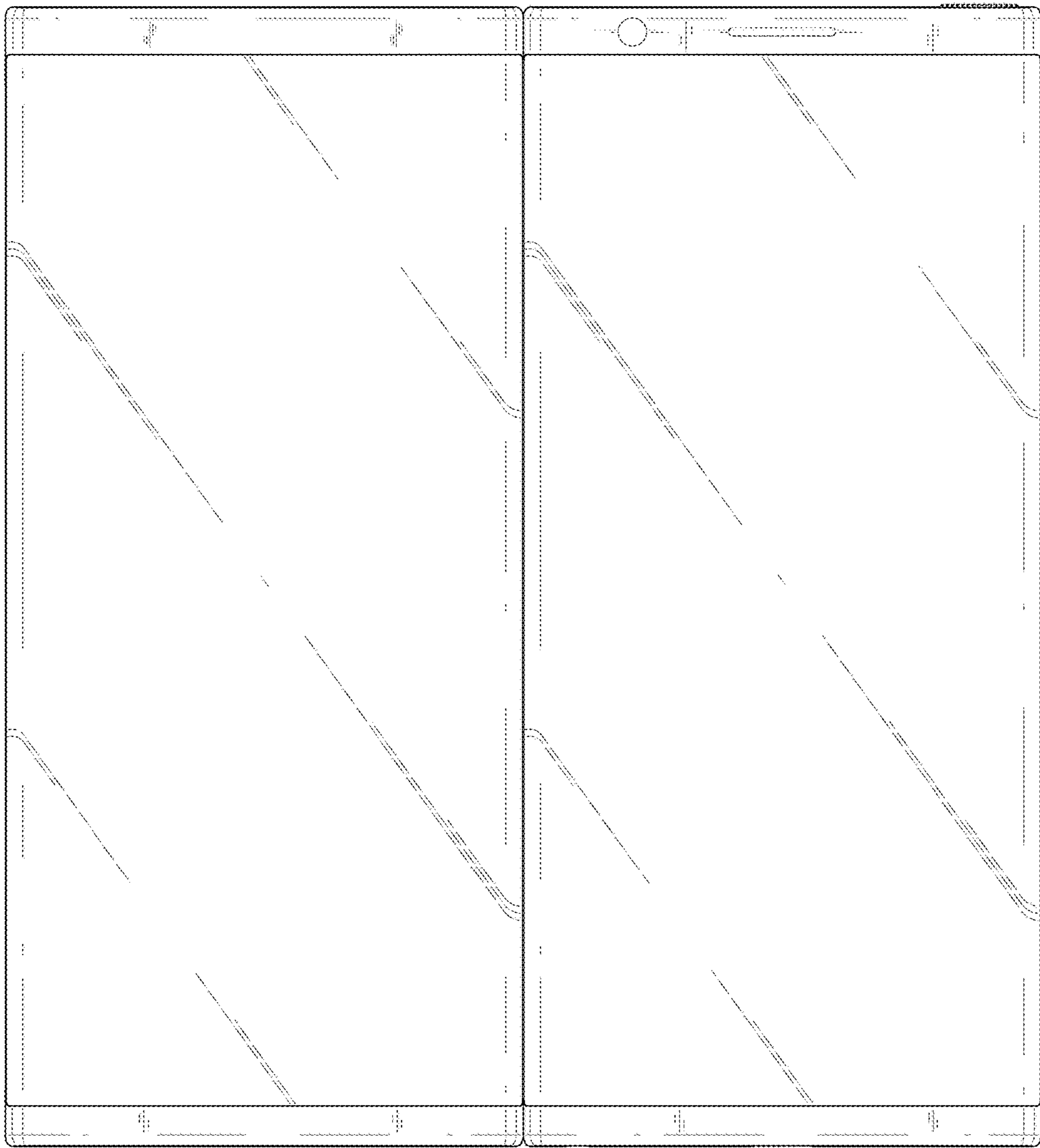

FIG. 19



FIG. 20

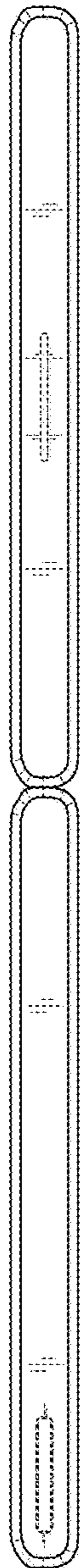

FIG. 21

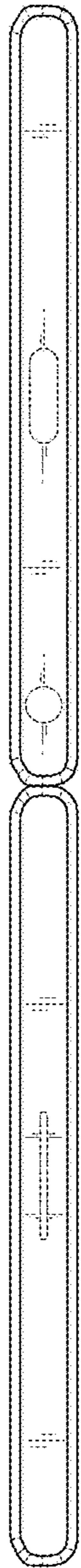

FIG. 22

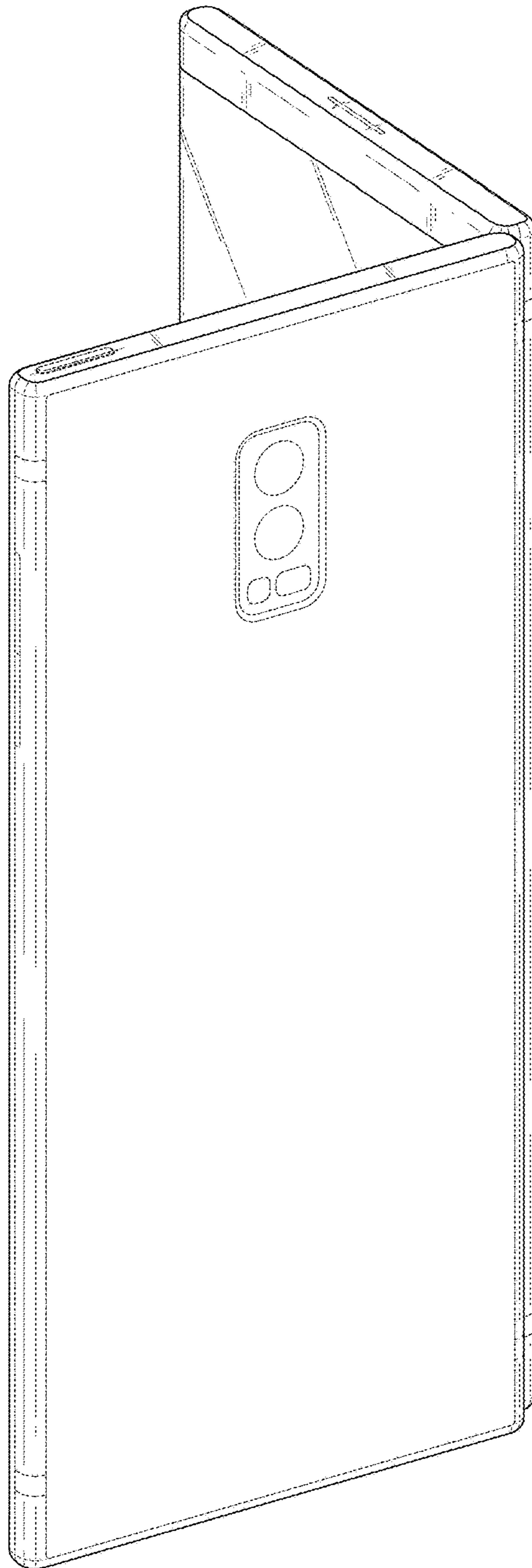

FIG. 23

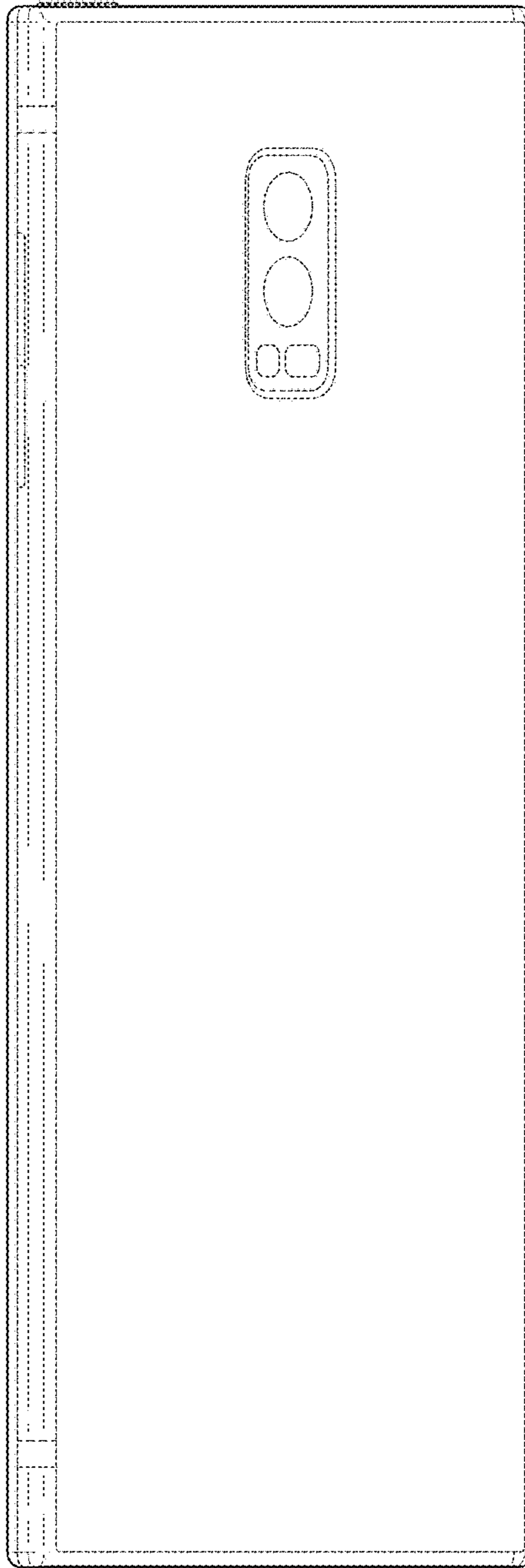

FIG. 24

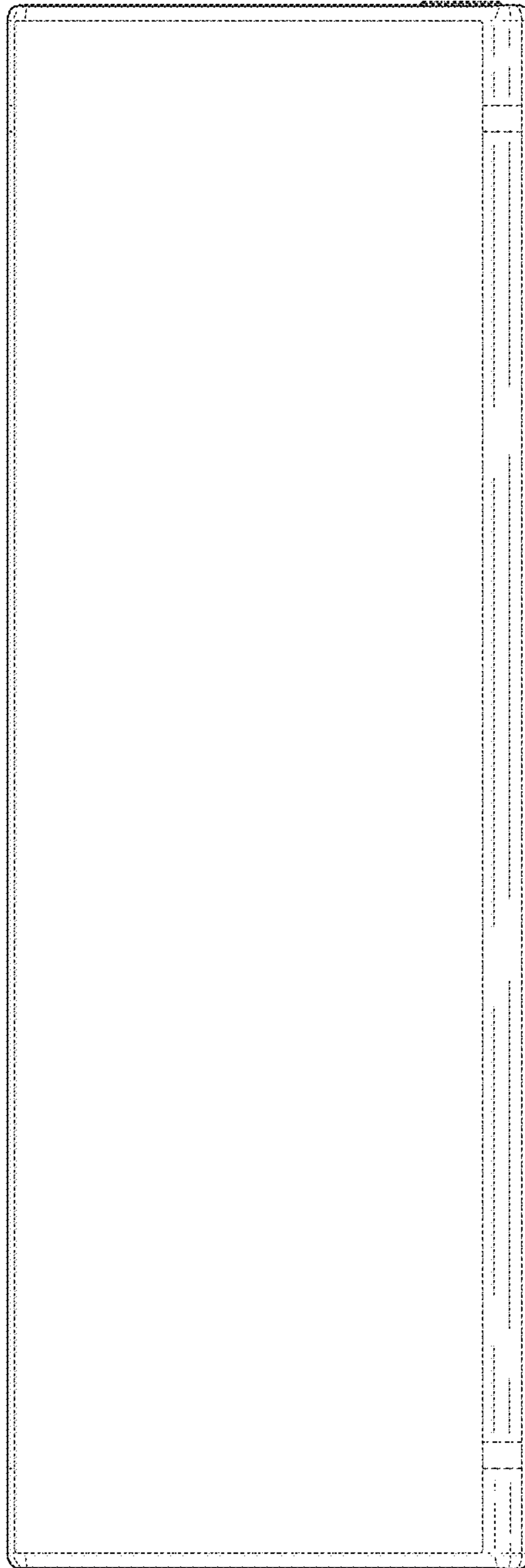

FIG. 25

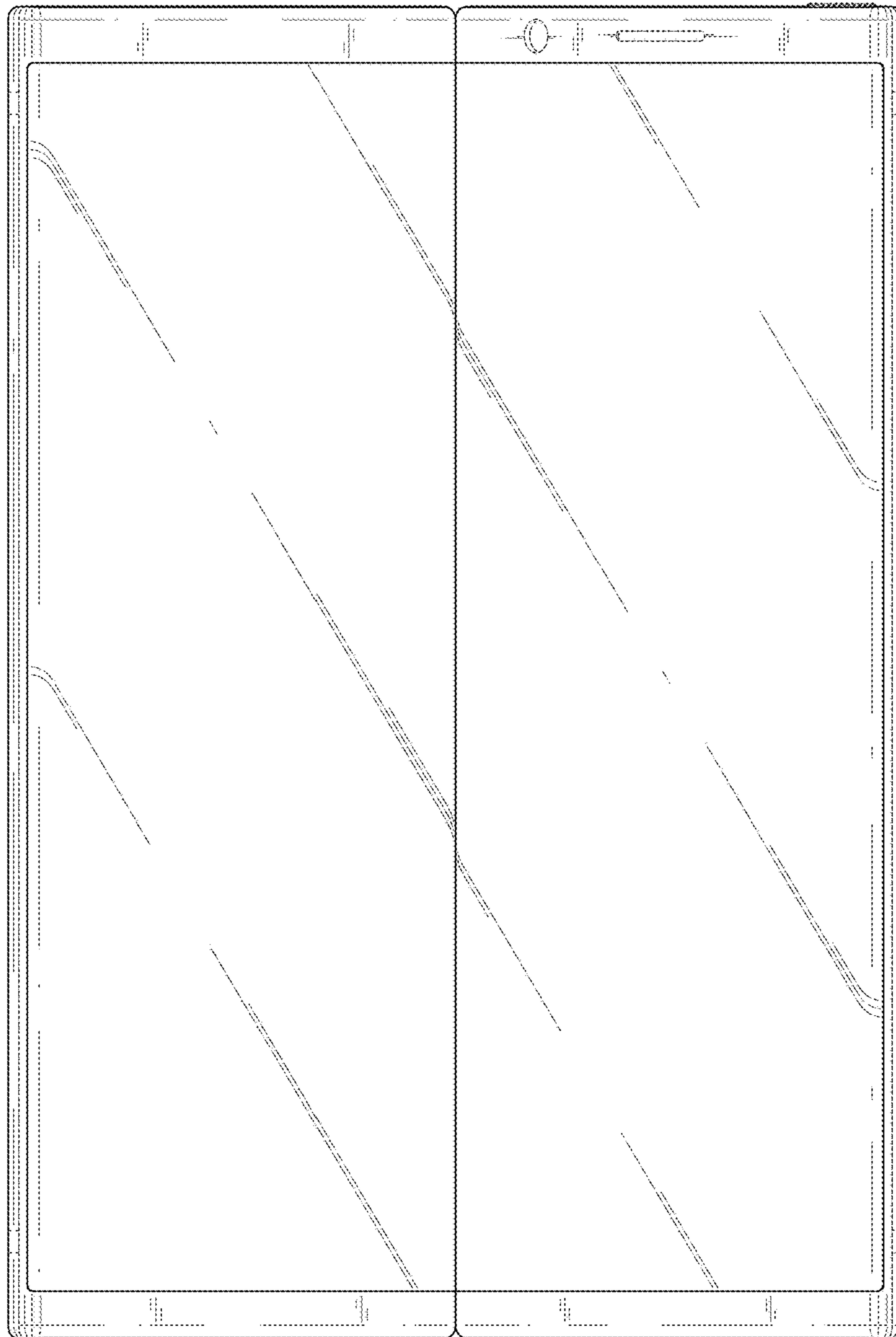

FIG. 26

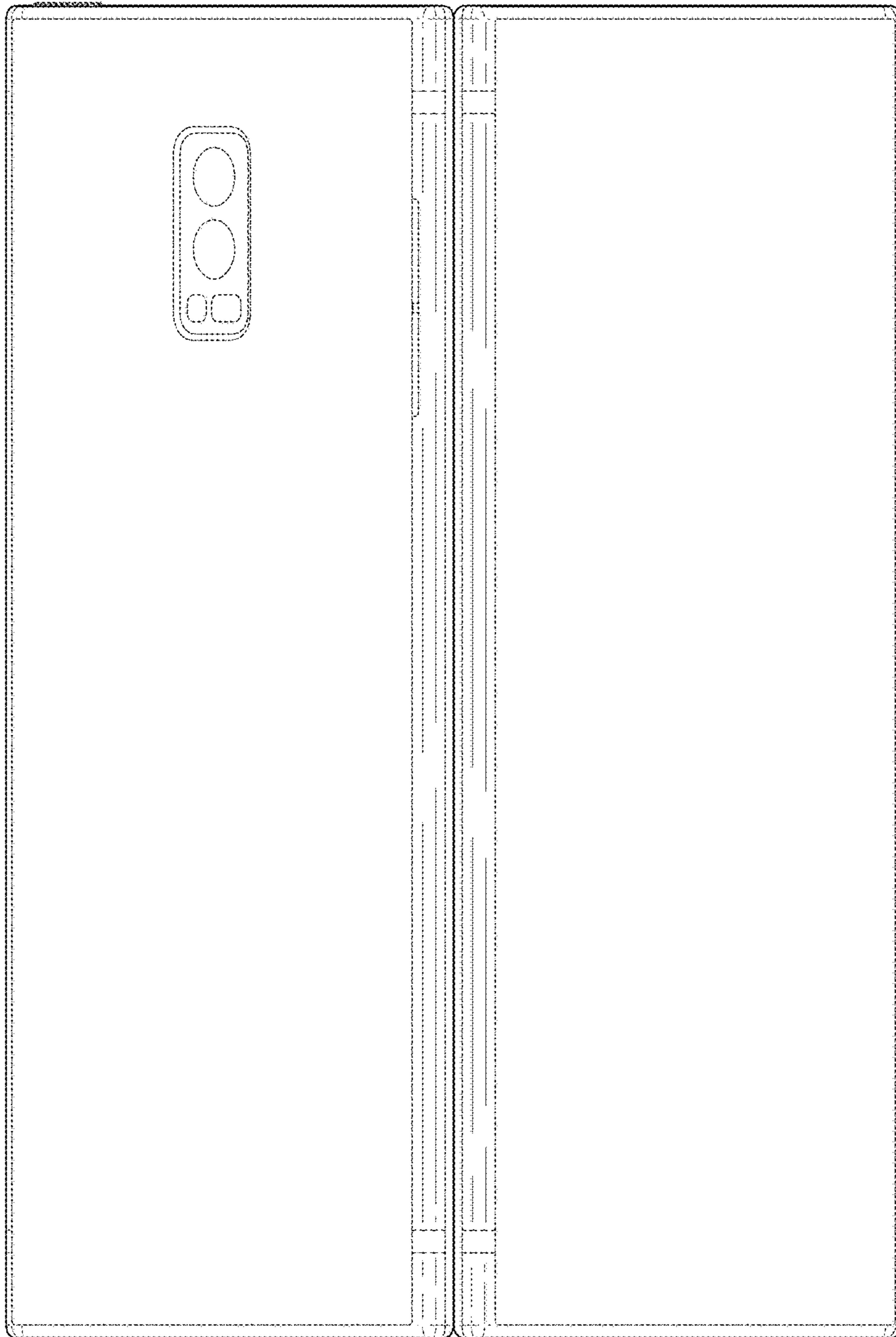

FIG. 27

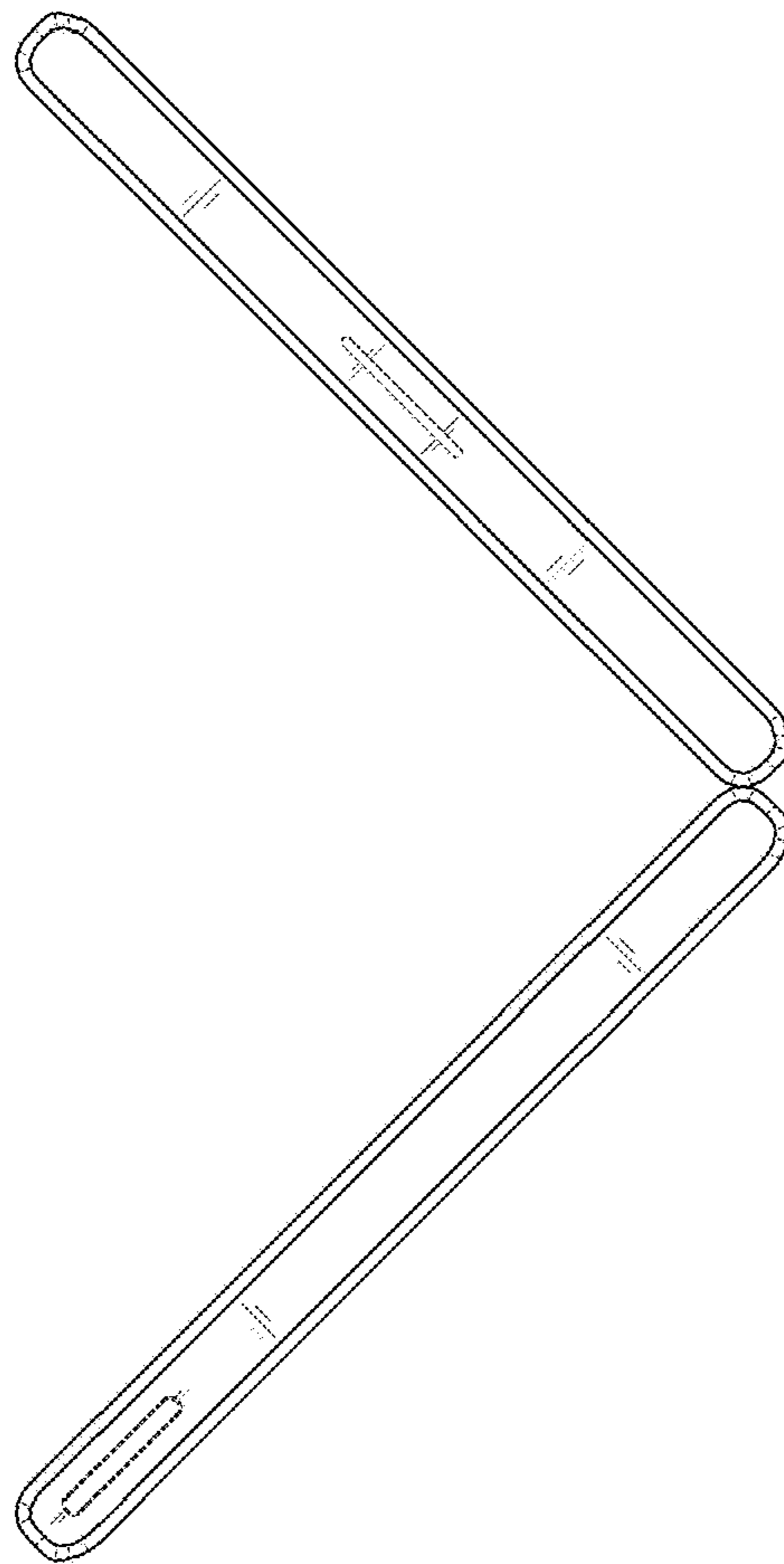

FIG. 28

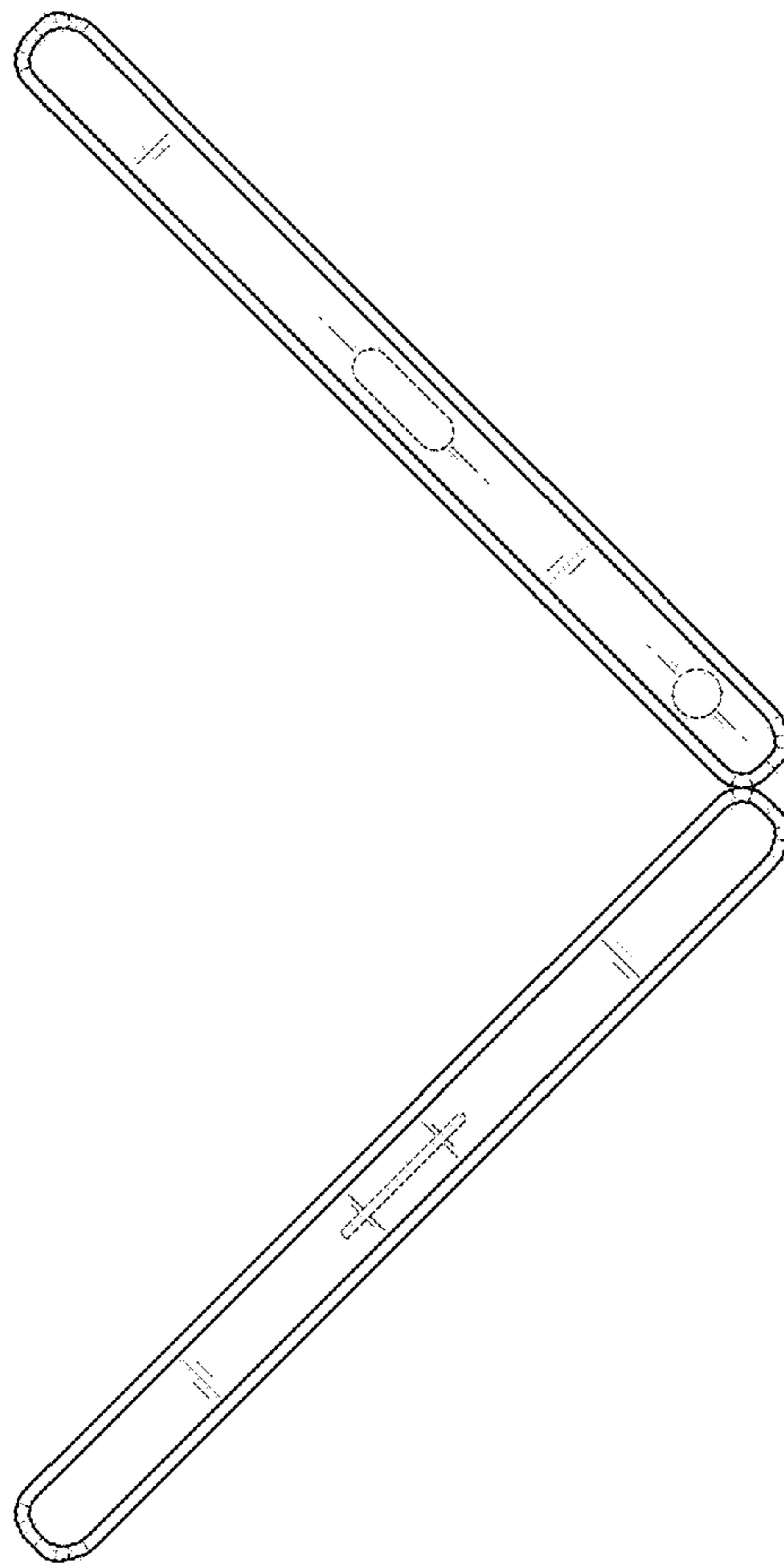

FIG. 29

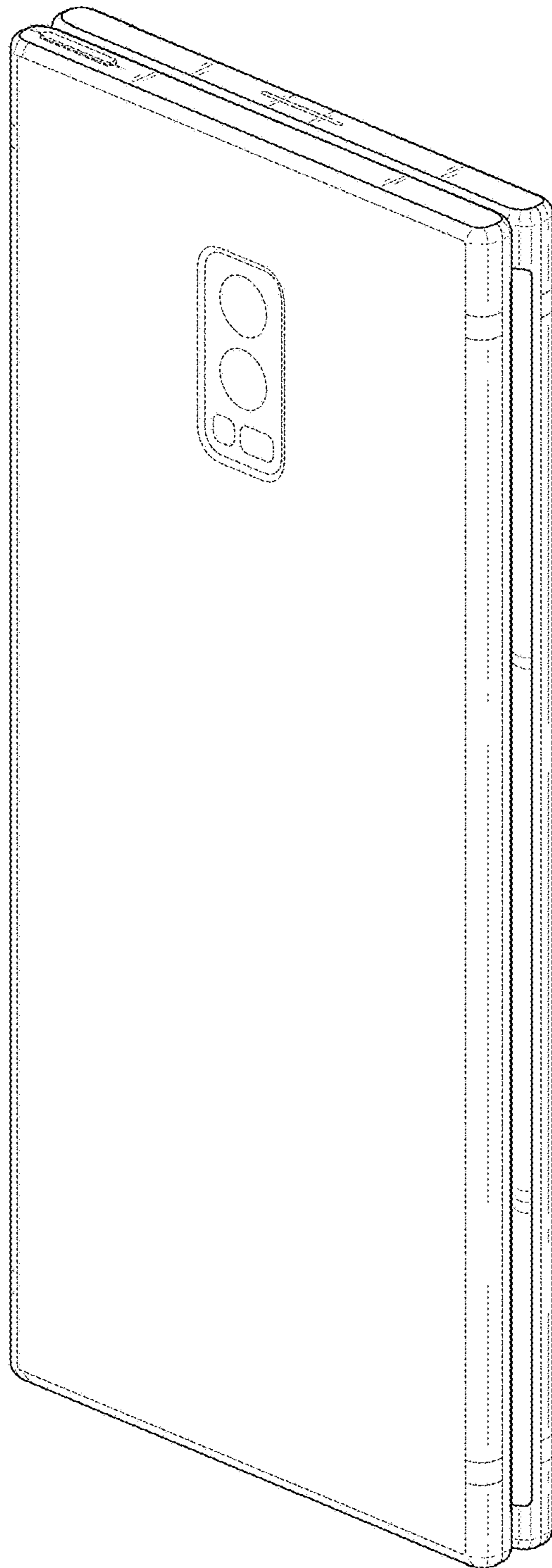

FIG. 30

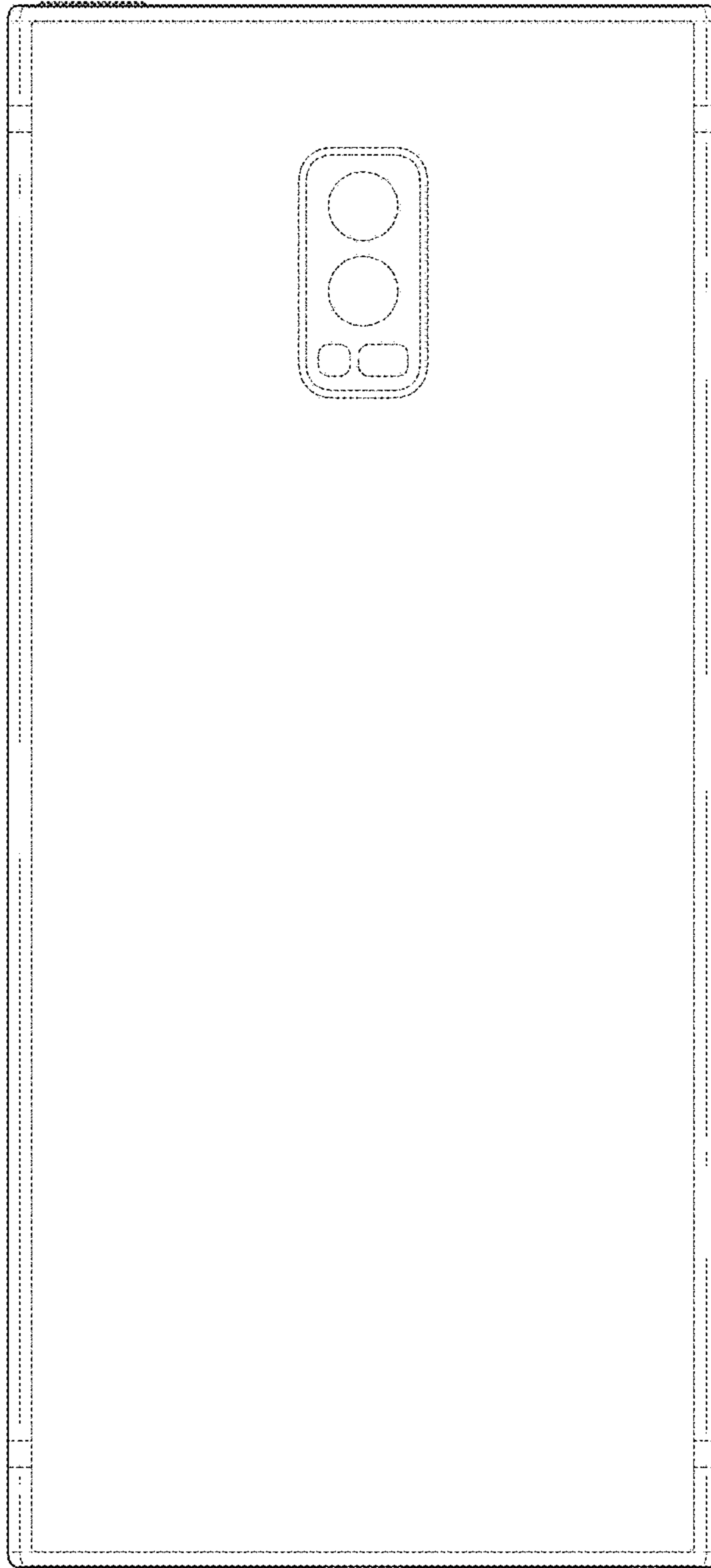

FIG. 31

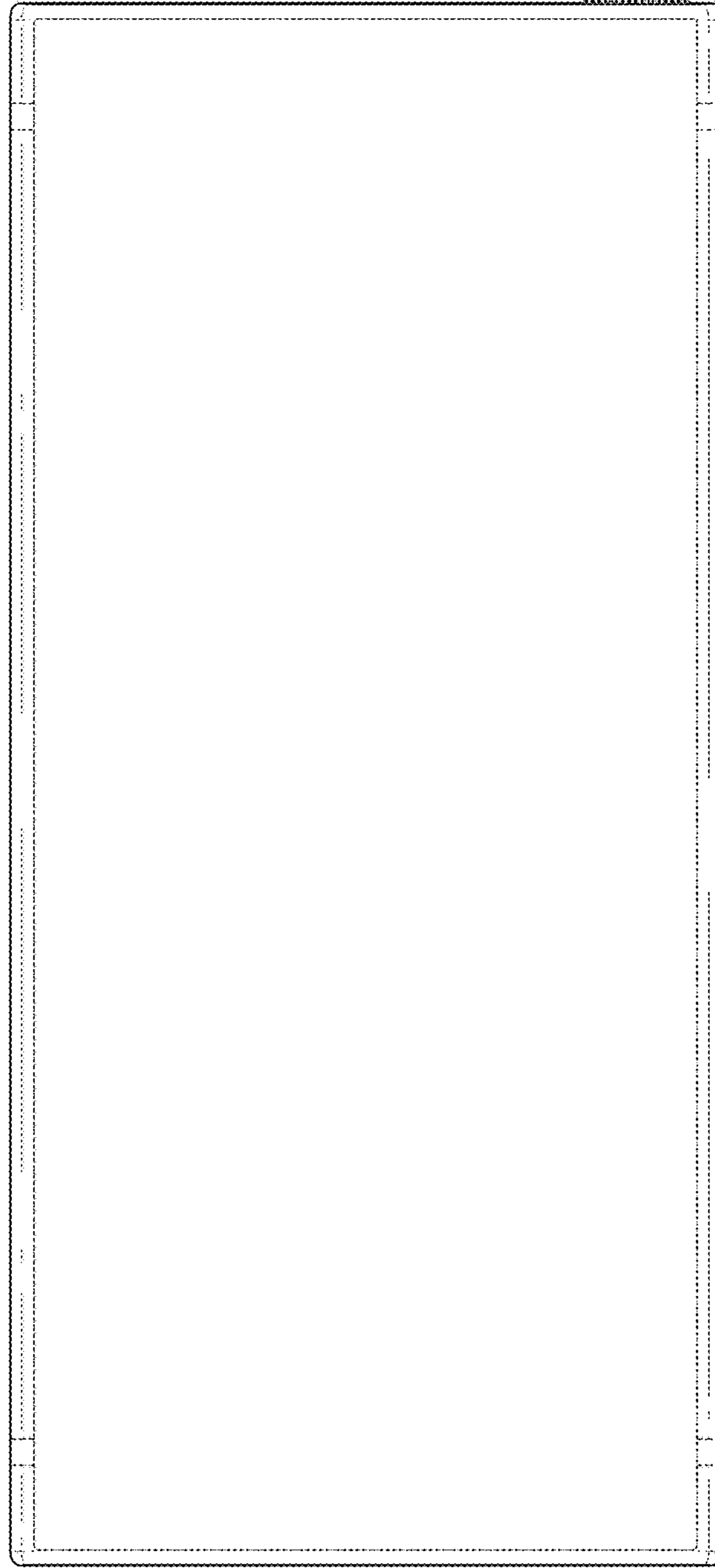

FIG. 32

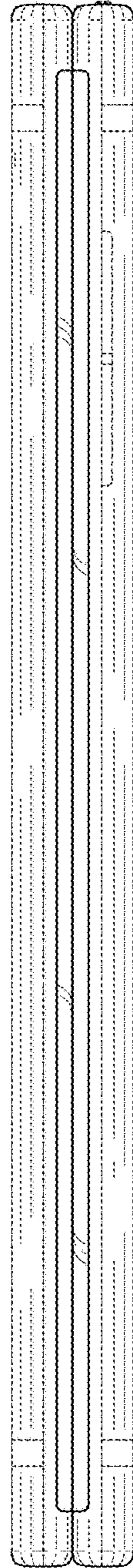

FIG. 33

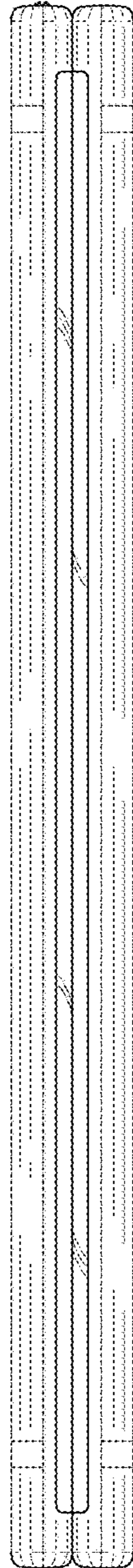

FIG. 34

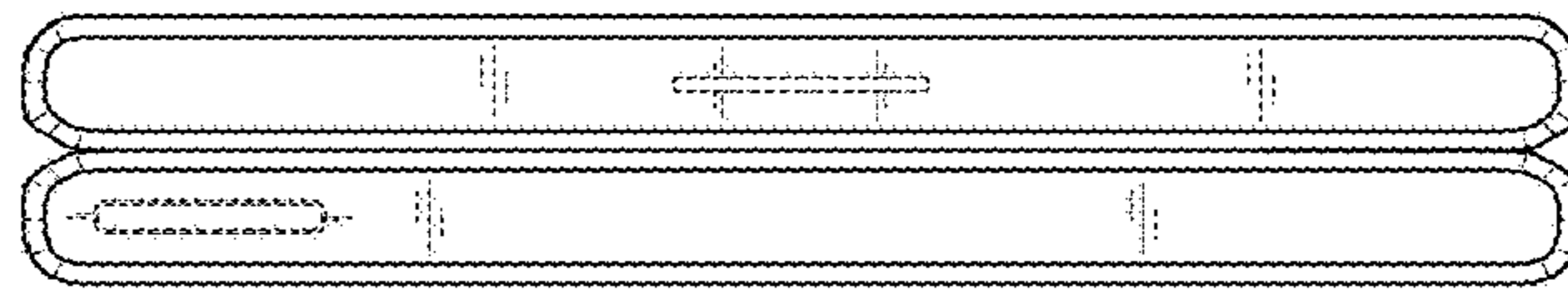

FIG. 35

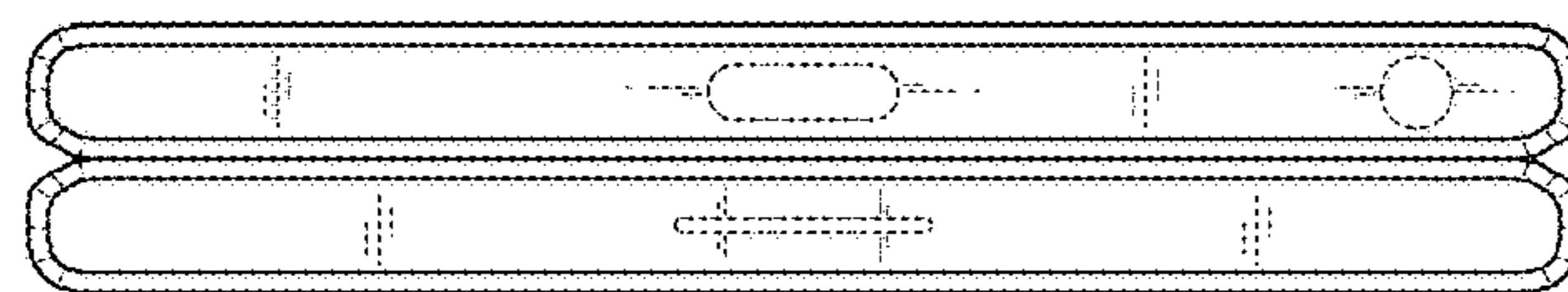

FIG. 36

