



US00D840309S

(12) **United States Design Patent**
Huang

(10) **Patent No.:** **US D840,309 S**
(45) **Date of Patent:** **** Feb. 12, 2019**

(54) **RUNNING BOARD**
(71) Applicant: **Winbo-Dongjian Automotive Technology Co., Ltd.**, Foshan (CN)
(72) Inventor: **Wentao Huang**, Guangdong (CN)
(73) Assignee: **WINBO-Dongjian Automotive Technology Co., Ltd.** (CN)
(**) Term: **15 Years**

D549,145 S * 8/2007 Kieffer D12/203
7,287,770 B2 * 10/2007 Drabant B60R 3/002
280/163
D596,098 S * 7/2009 Huang-Tsai D12/203
D632,627 S * 2/2011 Huang-Tsai D12/203
D741,769 S * 10/2015 Turner D12/203
D742,798 S * 11/2015 Wegener D12/203
D789,857 S * 6/2017 Hare D12/203
D789,858 S * 6/2017 Hare D12/203
2005/0067741 A1 * 3/2005 Chapman B29C 49/20
264/516
2011/0266766 A1 * 11/2011 Huang-Tsai B60R 3/00
280/169

(21) Appl. No.: **29/606,597**

* cited by examiner

(22) Filed: **Jun. 6, 2017**

Primary Examiner — Michelle E. Wilson

Assistant Examiner — Clese Moore, Jr.

(30) **Foreign Application Priority Data**

(74) *Attorney, Agent, or Firm* — Lerner, David, Littenberg, Krumholz & Mentlik, LLP

Dec. 7, 2016 (CN) 2016 3 0598529

(51) **LOC (11) Cl.** **12-16**

(57) **CLAIM**

(52) **U.S. Cl.**
USPC **D12/203**

The ornamental design for a running board, as shown and described.

(58) **Field of Classification Search**
USPC D12/203, 89, 98, 314, 162, 190, 196
CPC B60R 3/002; B60R 3/00; B60R 3/005;
B60R 3/007
See application file for complete search history.

DESCRIPTION

FIG. 1 is a front view of a running board according to my design;
FIG. 2 is a rear view thereof;
FIG. 3 is a left side view thereof;
FIG. 4 is a right side view thereof;
FIG. 5 is a top view thereof;
FIG. 6 is a bottom view thereof; and,
FIG. 7 is a perspective view thereof.

(56) **References Cited**

U.S. PATENT DOCUMENTS

D434,711 S * 12/2000 McQuiston D12/203
D473,178 S * 4/2003 Schumacher D12/203
D488,759 S * 4/2004 Hattori D12/203

1 Claim, 7 Drawing Sheets

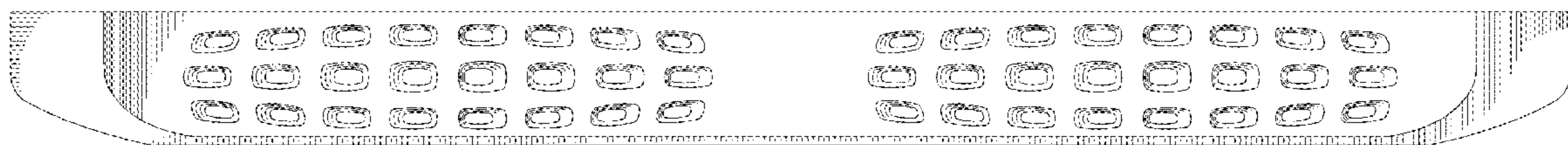

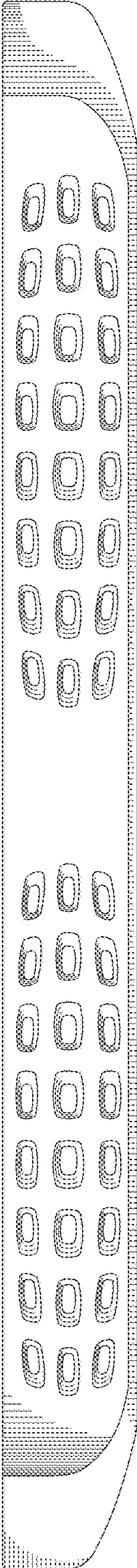

Fig. 1

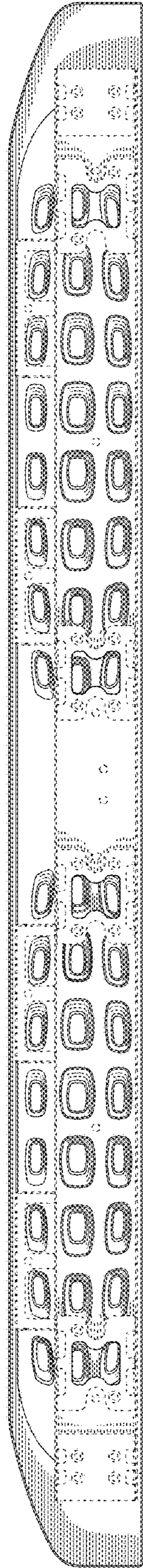

Fig. 2

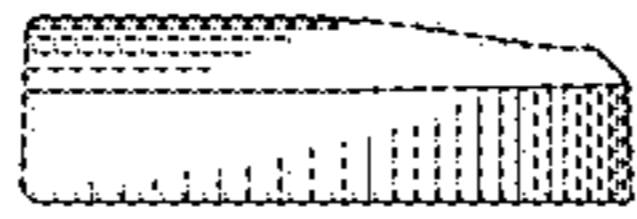

Fig. 3

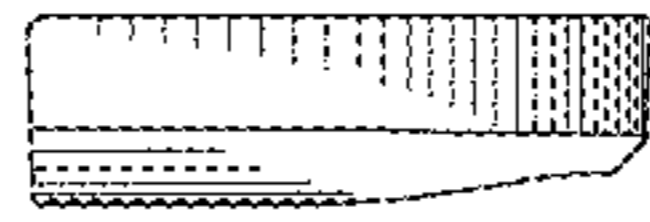

Fig. 4

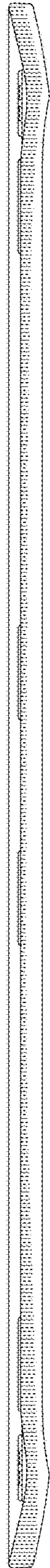

Fig. 5

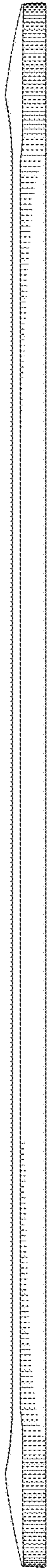

Fig. 6

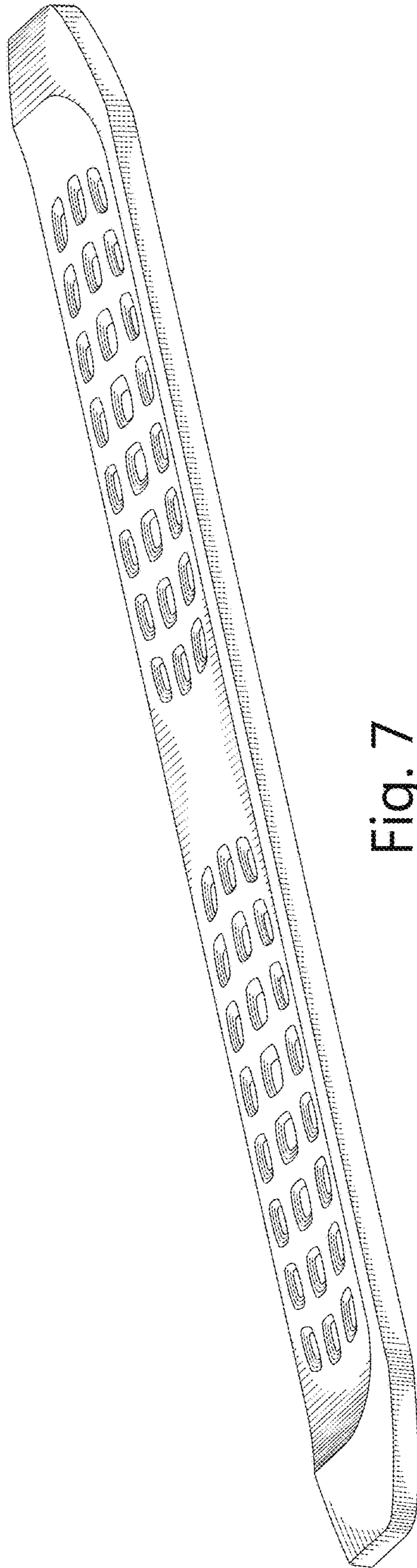

Fig. 7