



US00D840301S

(12) **United States Design Patent**
Bonetti

(10) **Patent No.:** **US D840,301 S**

(45) **Date of Patent:** **** Feb. 12, 2019**

(54) **DISC BRAKE CALIPER**

(71) Applicant: **FRENI BREMBO S.p.A.**, Curno
(Bergamo) (IT)

(72) Inventor: **Fabrizio Bonetti**, Curno (IT)

(73) Assignee: **FRENI BREMBO S.p.A.**, Curno
(Bergamo) (IT)

(**) Term: **15 Years**

(21) Appl. No.: **29/590,012**

(22) Filed: **Jan. 6, 2017**

(30) **Foreign Application Priority Data**

Jul. 8, 2016 (IT) 402016000071481

(51) **LOC (11) Cl.** **12-16**

(52) **U.S. Cl.**
USPC **D12/180**

(58) **Field of Classification Search**

USPC D12/179, 180; 188/72.3, 73.31, 72.4,
188/73.46, 72.5, 18 A, 72.1, 73.39

CPC F16D 65/0068; F16D 65/18; F16D
2055/0016; F16D 55/226; F16D 65/183;
F16D 65/58

See application file for complete search history.

(56) **References Cited**

U.S. PATENT DOCUMENTS

D512,352 S * 12/2005 Veneziano D12/180
D520,924 S * 5/2006 Gotti D12/180

D642,100 S * 7/2011 Crippa D12/180
9,388,870 B2 * 7/2016 Cesani F16D 65/18
D790,417 S * 6/2017 Bertone D12/180
2013/0092481 A1 * 4/2013 Crippa F16D 55/228
188/73.31
2014/0231190 A1 * 8/2014 Cesani F16D 65/18
188/72.3
2017/0284488 A1 * 10/2017 Crippa F16D 65/0006

* cited by examiner

Primary Examiner — Cynthia Ramirez

Assistant Examiner — Gino Colan

(74) *Attorney, Agent, or Firm* — Thomas | Horstemeyer,
LLP

(57) **CLAIM**

The ornamental design for a disc brake caliper, as shown and described.

DESCRIPTION

FIG. 1 is a perspective view of a disc brake caliper showing my new design;

FIG. 2 is a perspective view thereof from the side opposite that of FIG. 1;

FIG. 3 is an end view thereof;

FIG. 4 is an end view thereof, from an end opposite that of FIG. 3;

FIG. 5 is a side view thereof;

FIG. 6 is a side view thereof, from a side opposite that of FIG. 5;

FIG. 7 is a top view thereof; and,

FIG. 8 bottom view thereof.

1 Claim, 8 Drawing Sheets

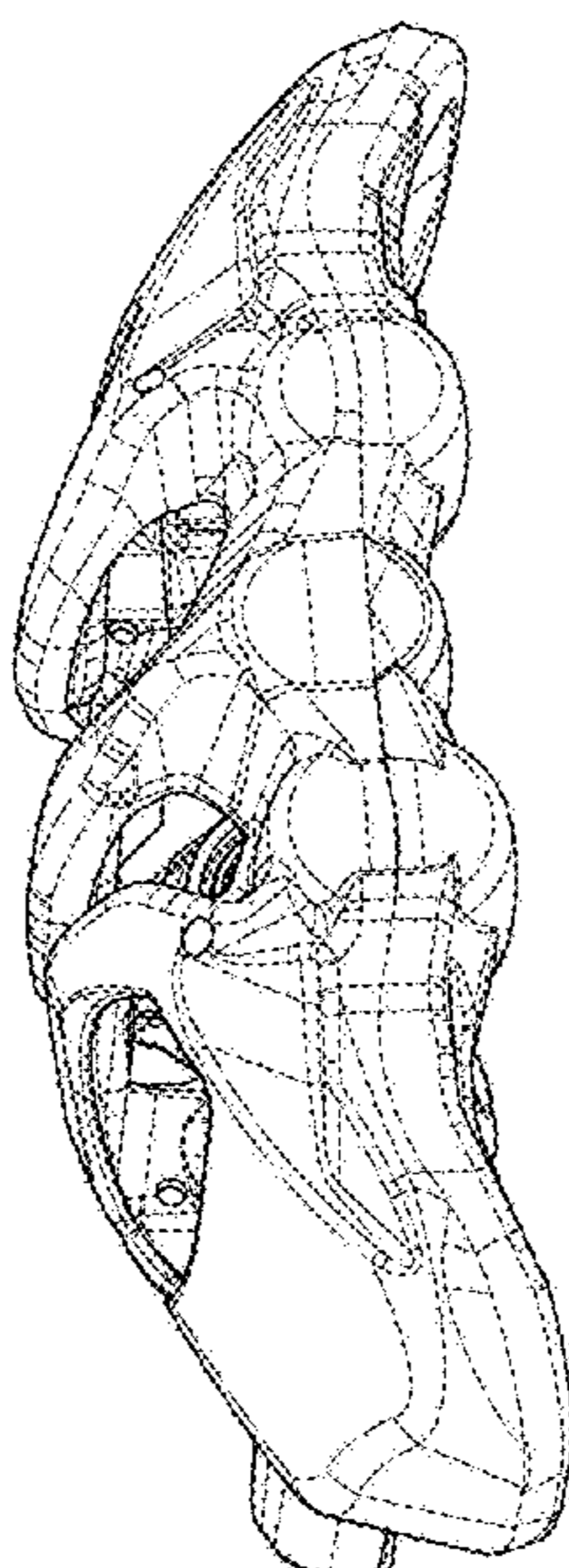

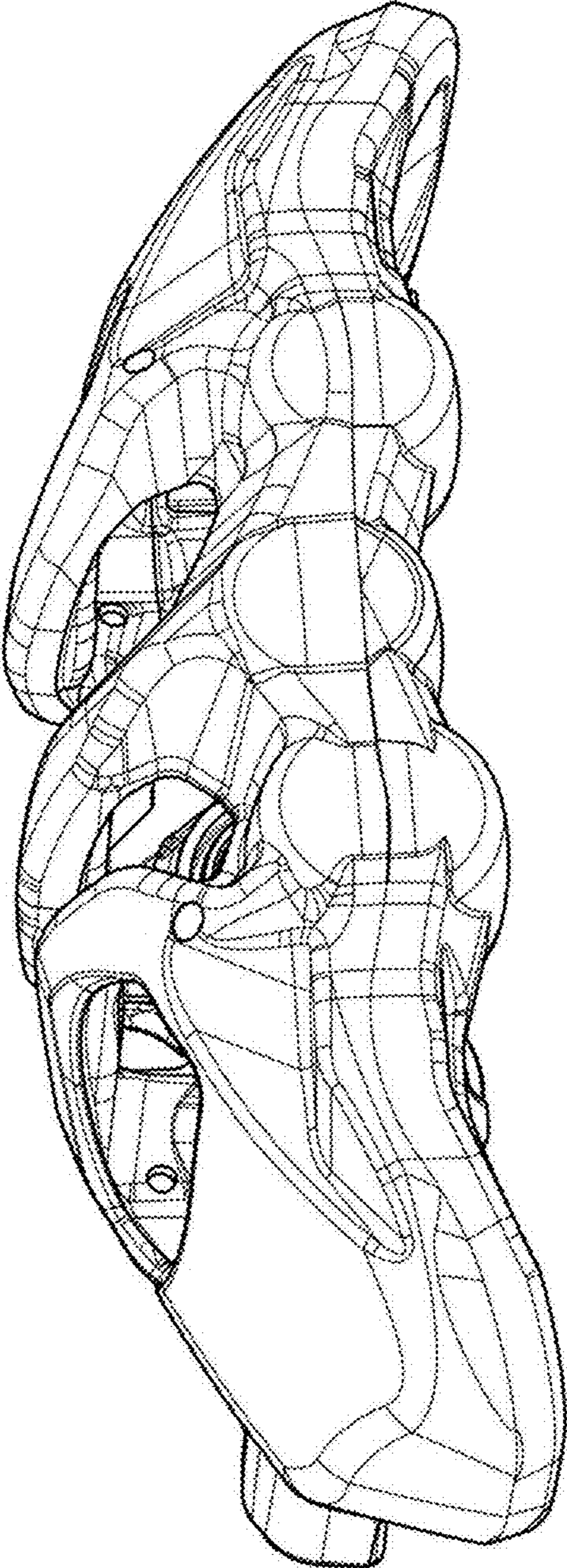

FIG. 1

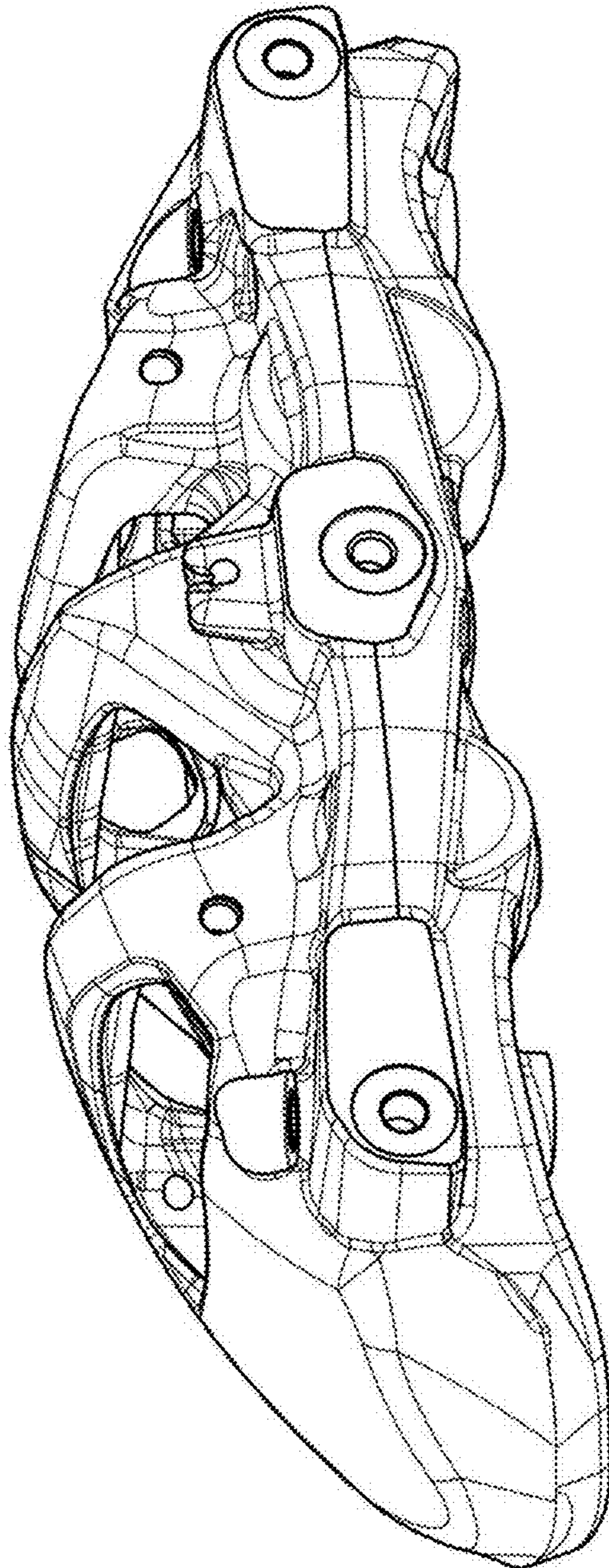

FIG. 2

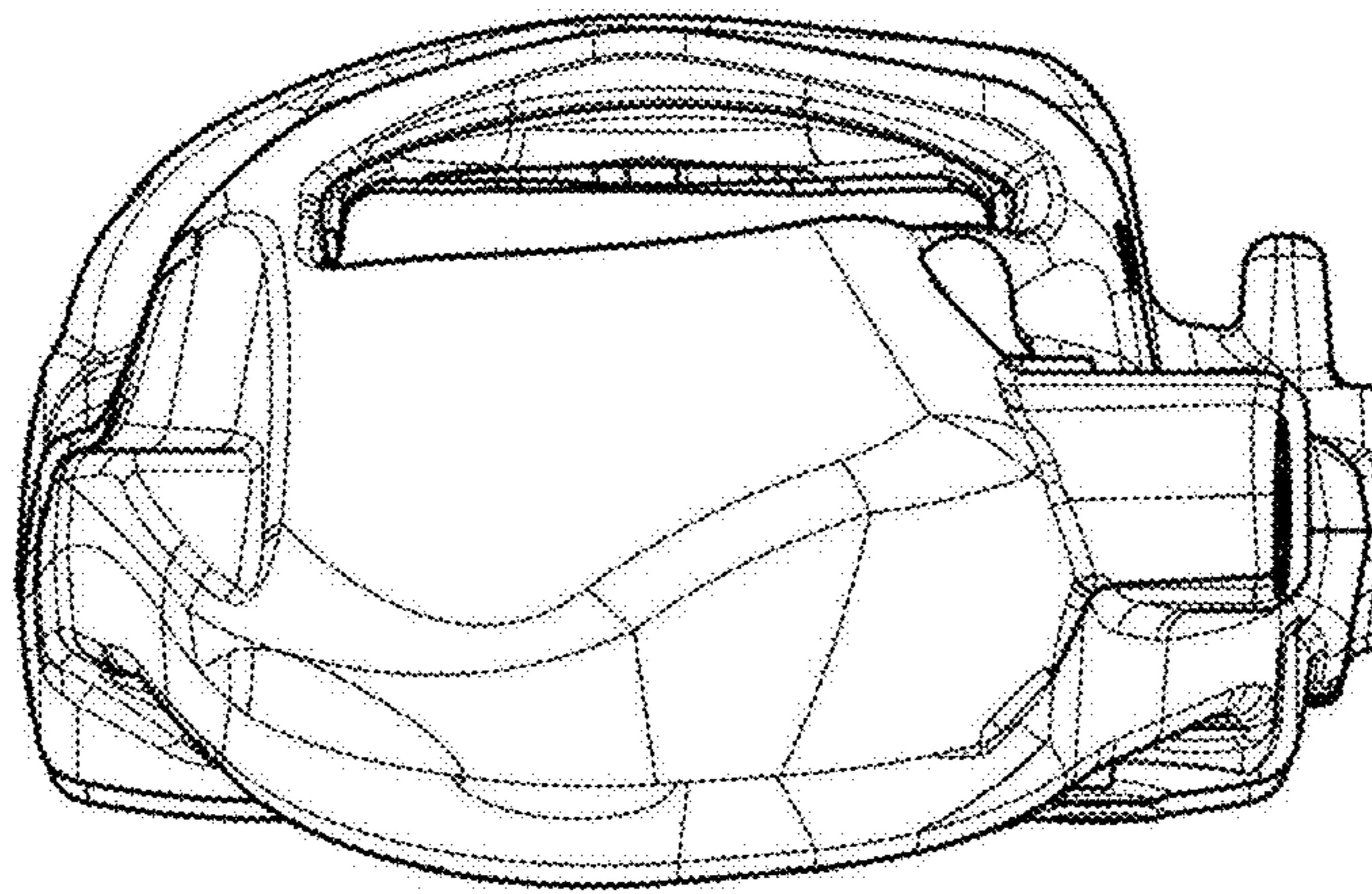

FIG. 3

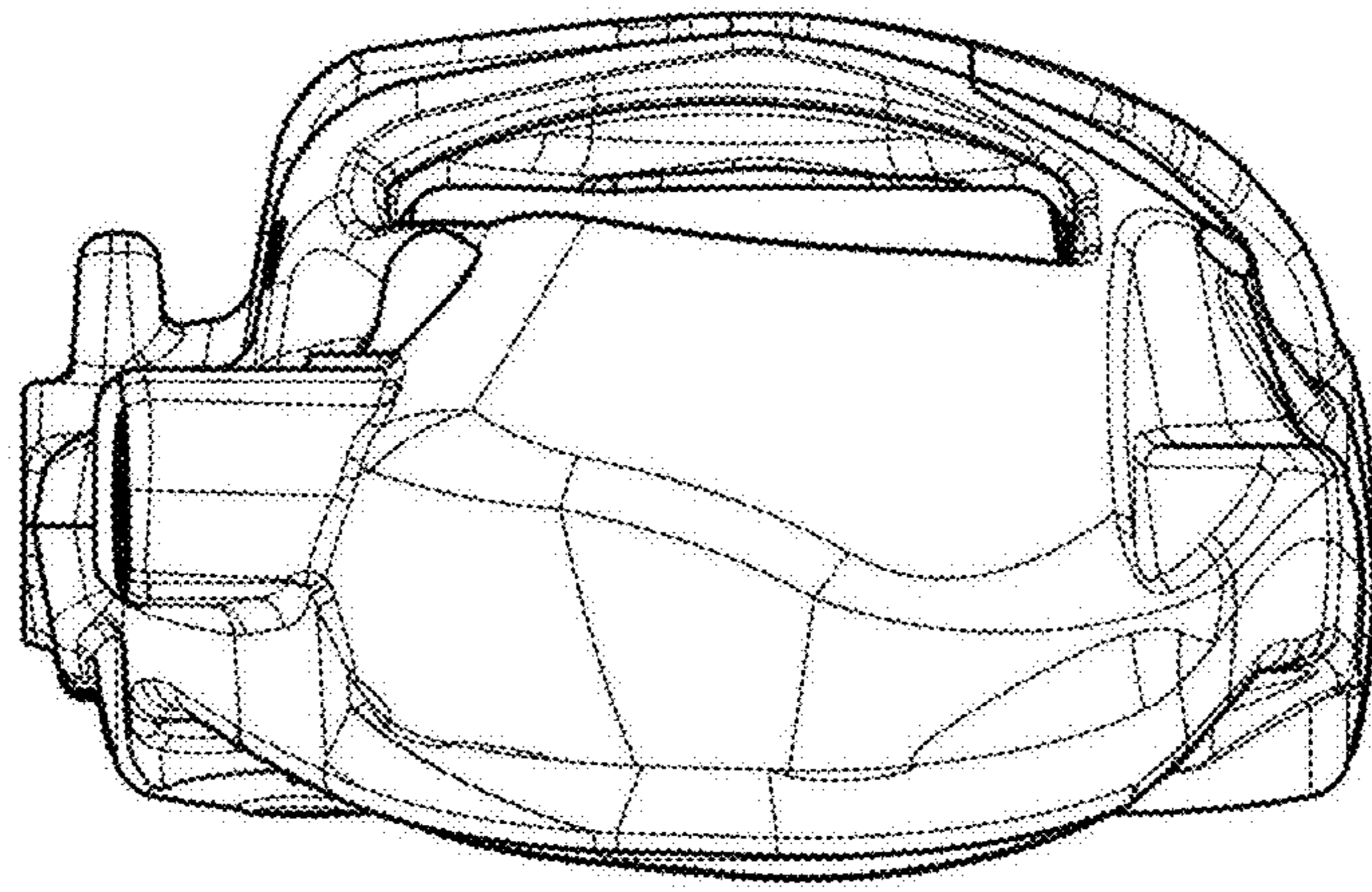

FIG. 4

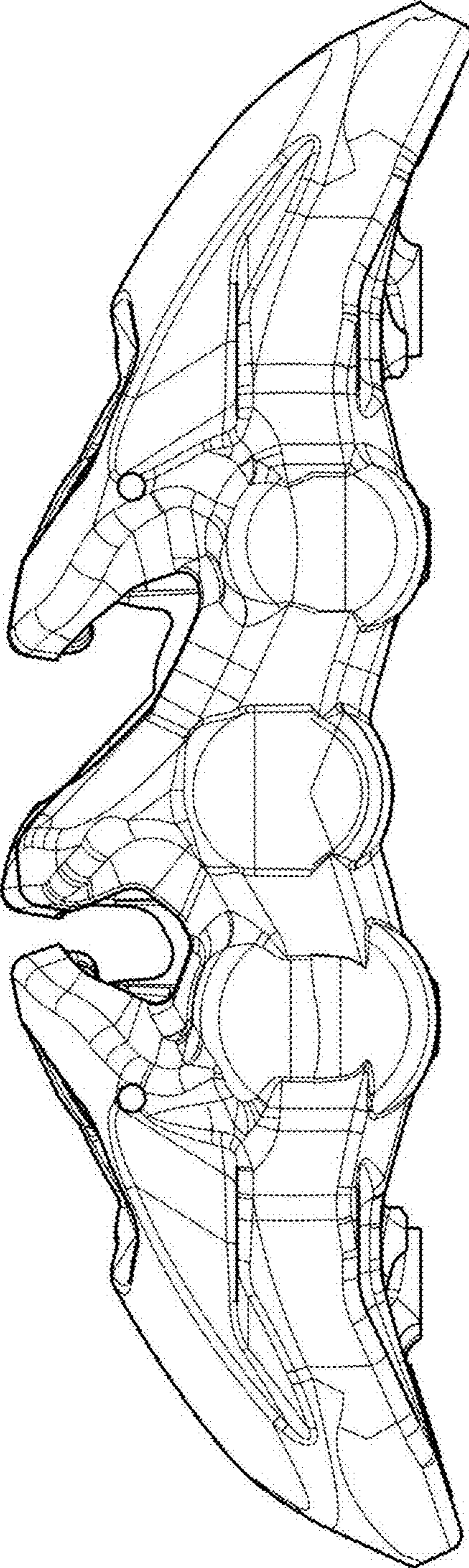

FIG. 5

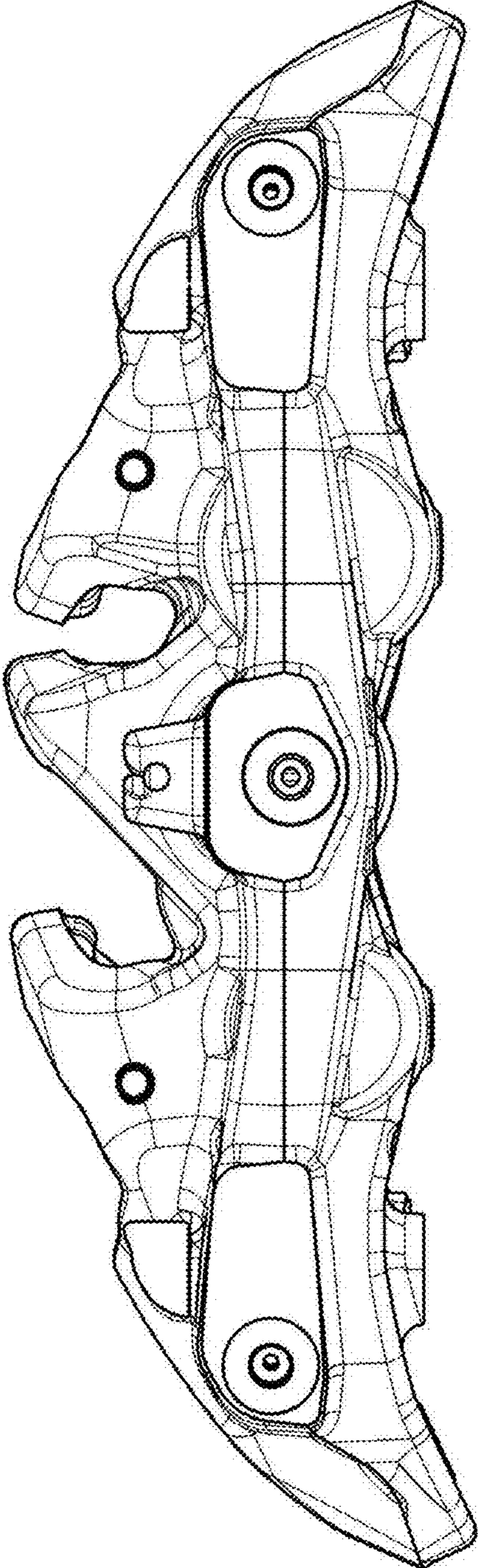

FIG. 6

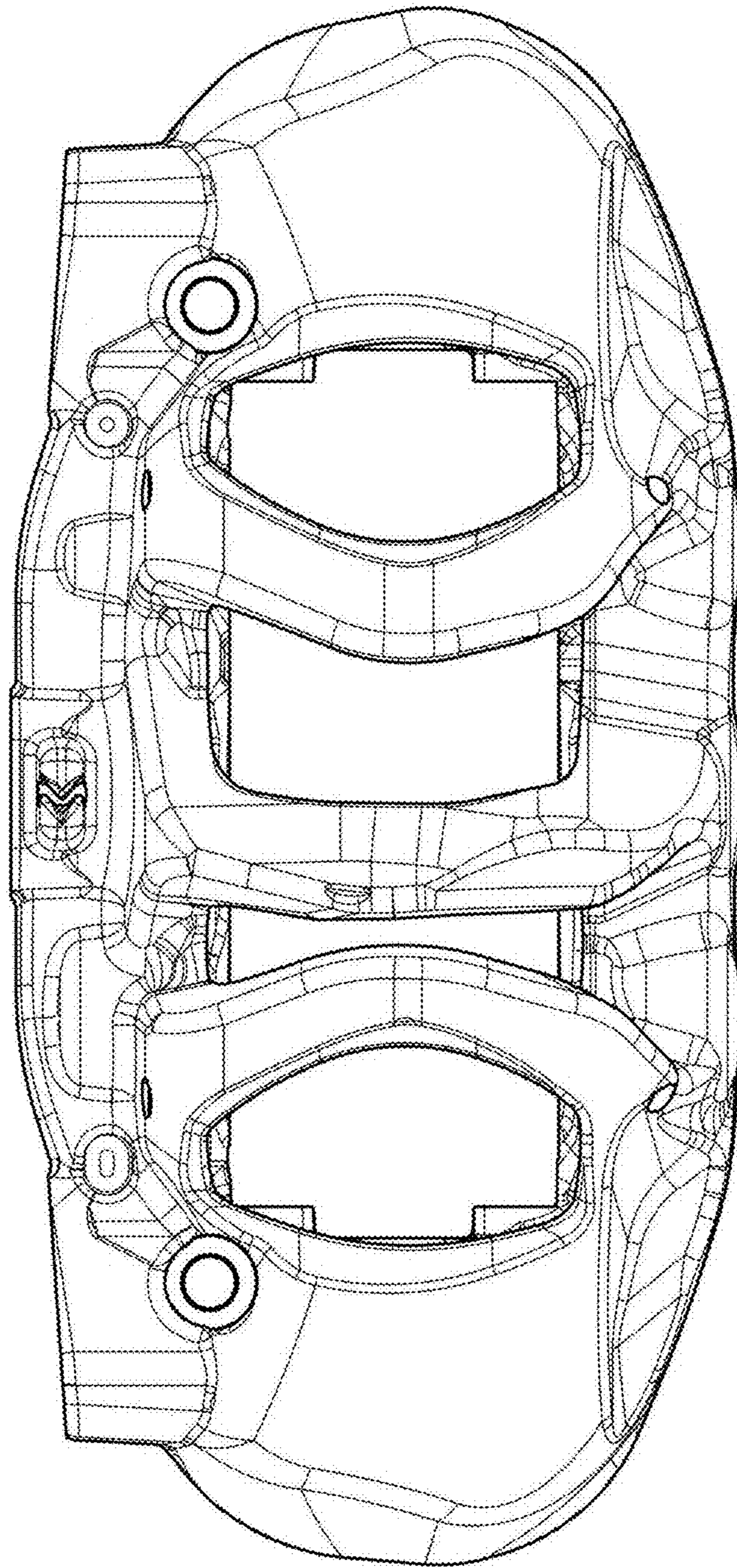

FIG. 7

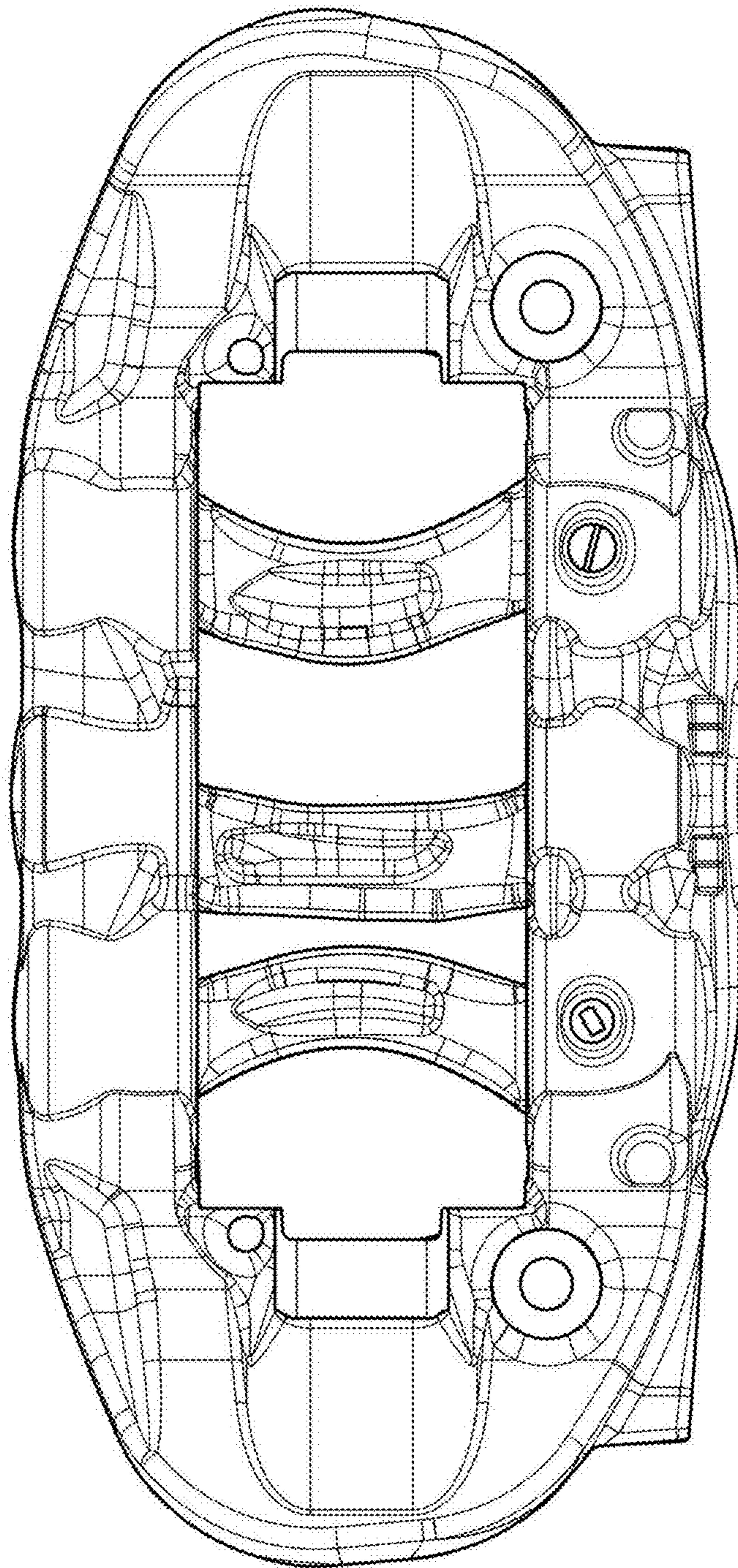

FIG. 8