



US00D840236S

(12) **United States Design Patent** (10) **Patent No.:** **US D840,236 S**
Arianpour (45) **Date of Patent:** **** Feb. 12, 2019**

(54) **WATER BOTTLE WITH HANDLE**
(71) Applicant: **Unix Packaging Inc.**, Montebello, CA (US)
(72) Inventor: **Shahab Shawn Arianpour**, Los Angeles, CA (US)
(73) Assignee: **Unix Packaging, Inc.**, Montebello, CA (US)

D635,460 S * 4/2011 Dorn D9/522
D660,710 S * 5/2012 Kallenbach D9/528
D668,957 S * 10/2012 Kallenbach D9/435
D685,643 S * 7/2013 Kallenbach D9/528
2008/0083764 A1* 4/2008 Kaminski A47J 45/06
220/660

(**) Term: **15 Years**

(21) Appl. No.: **29/592,871**

(22) Filed: **Feb. 3, 2017**

(51) **LOC (11) Cl.** **09-01**

(52) **U.S. Cl.**
USPC **D9/534**; D9/556; D9/520

(58) **Field of Classification Search**
USPC D9/522, 528, 530, 531, 534, 543, 549,
D9/558, 564, 565, 569, 572, 573;
215/40, 44, 200, 381-384, 396; 220/288,
220/662, 669, 675, 752, 755, 771;
222/182, 209; 426/115
CPC B65D 1/02; B65D 1/0223; B65D 1/0246;
B65D 5/46; B65D 41/00; B65D 41/02;
B65D 41/04; B65D 2501/00; B65D
2501/0009

See application file for complete search history.

(56) **References Cited**

U.S. PATENT DOCUMENTS

2,831,593 A * 4/1958 Sterges B65D 23/10
215/398
D303,497 S * 9/1989 Larson D9/520
5,954,216 A * 9/1999 Meisner B65D 23/10
215/384
D557,141 S * 12/2007 Pedmo D9/541

OTHER PUBLICATIONS

Lipton, "Iced Tea Lemon", downloaded from Internet <<https://www.walmart.com/ip/Lipton-Iced-Tea-Lemon-128-FI-Oz-1-Count/14532498>>, at least as early as Feb. 2, 2017, 1 page.

* cited by examiner

Primary Examiner — Derrick E Holland

Assistant Examiner — Janice Patyk

(74) *Attorney, Agent, or Firm* — Walter W. Duft

(57) **CLAIM**

The ornamental design for a water bottle with handle, as shown and described.

DESCRIPTION

FIG. 1 is an top, rear perspective view of a water bottle with handle, showing my new design;
FIG. 2 is a top, front perspective view thereof;
FIG. 3 is a bottom, rear perspective view thereof;
FIG. 4 is a bottom, front perspective view thereof;
FIG. 5 is a front elevation view thereof;
FIG. 6 is a rear elevation view thereof;
FIG. 7 is a right side elevation view thereof;
FIG. 8 is a left side elevation view thereof;
FIG. 9 is a top plan view thereof; and,
FIG. 10 is a bottom plan view thereof.

1 Claim, 10 Drawing Sheets

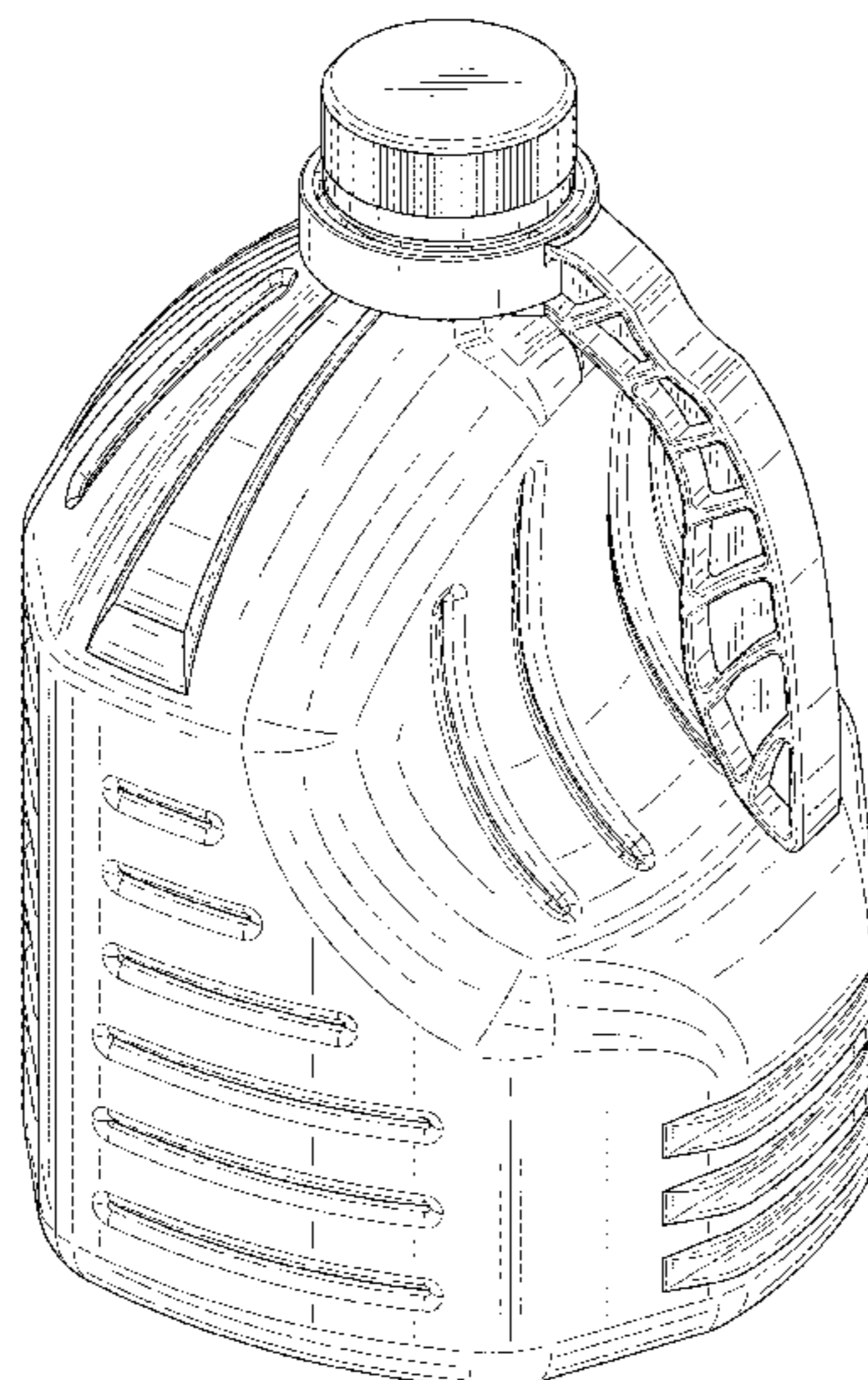

FIG. 1

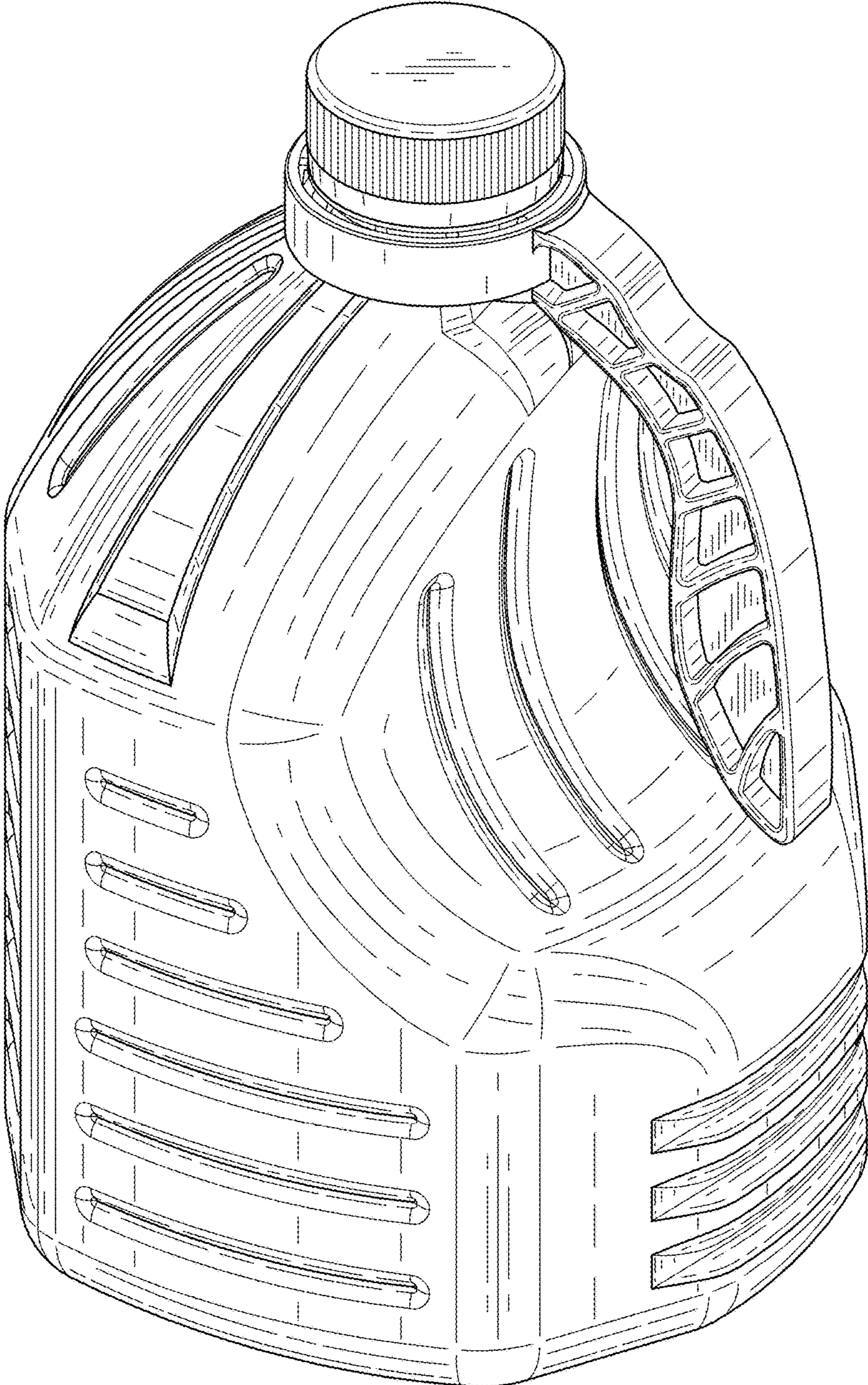

FIG. 2

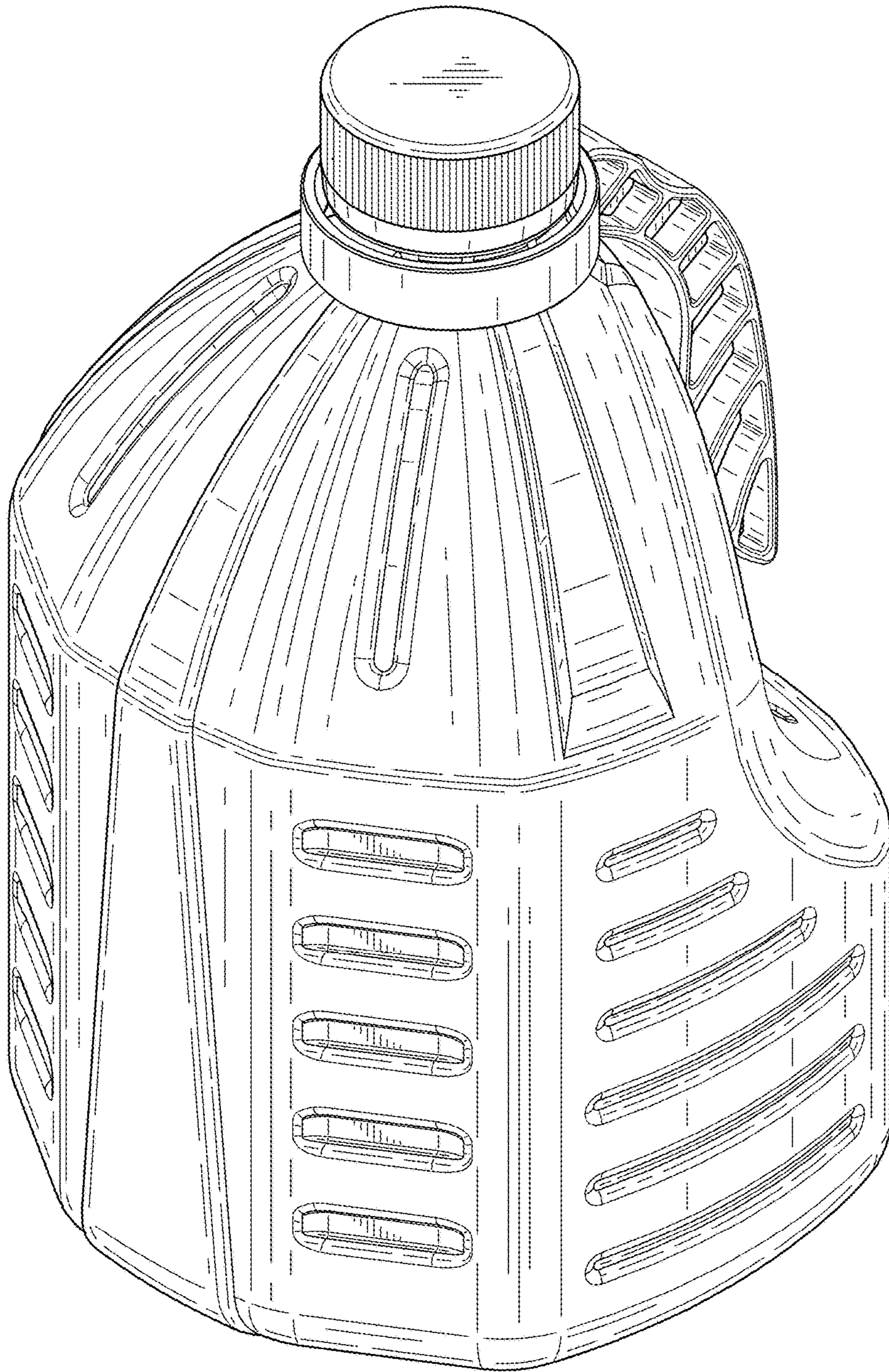

FIG. 3

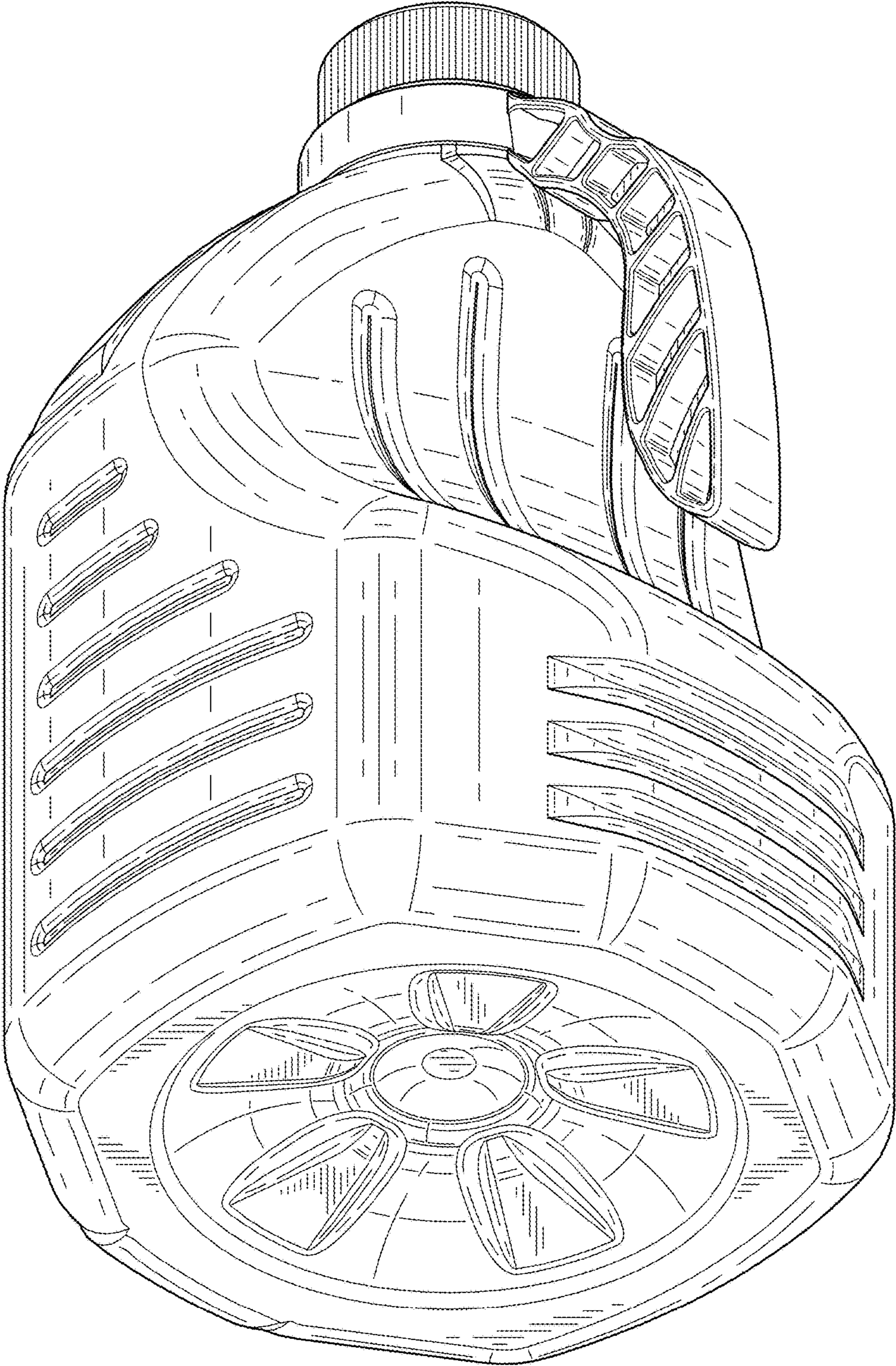

FIG. 4

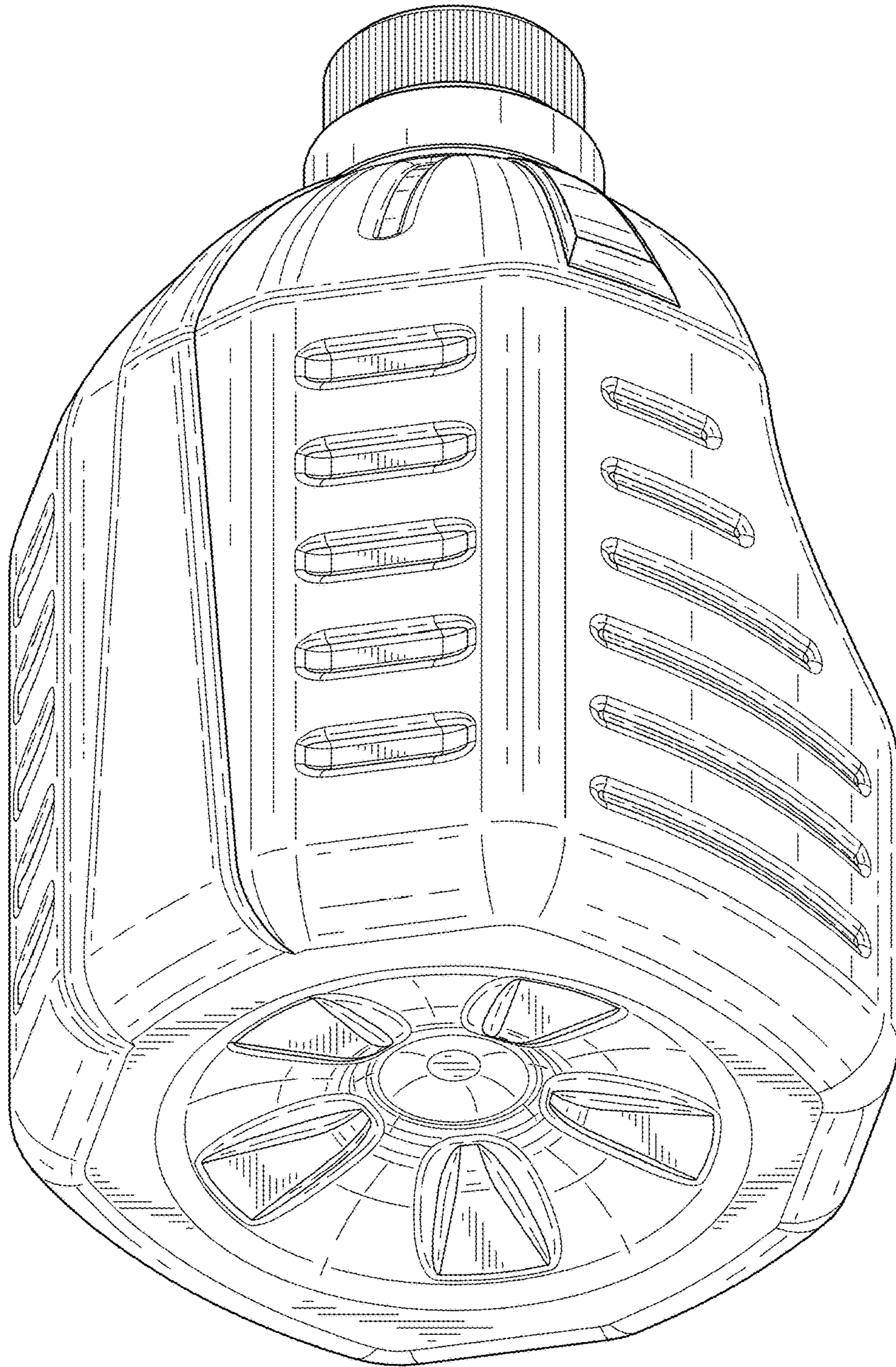

FIG. 5

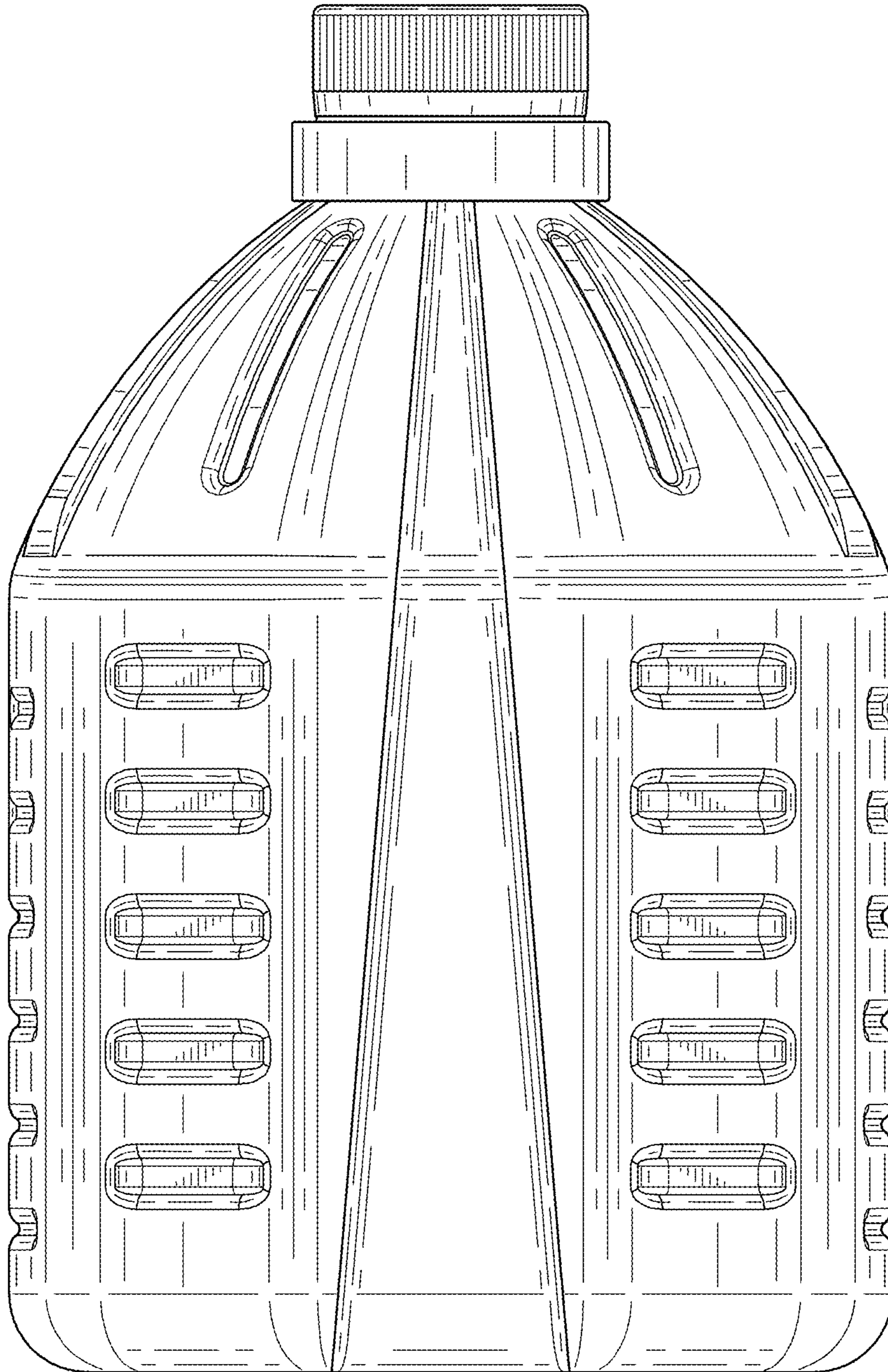

FIG. 6

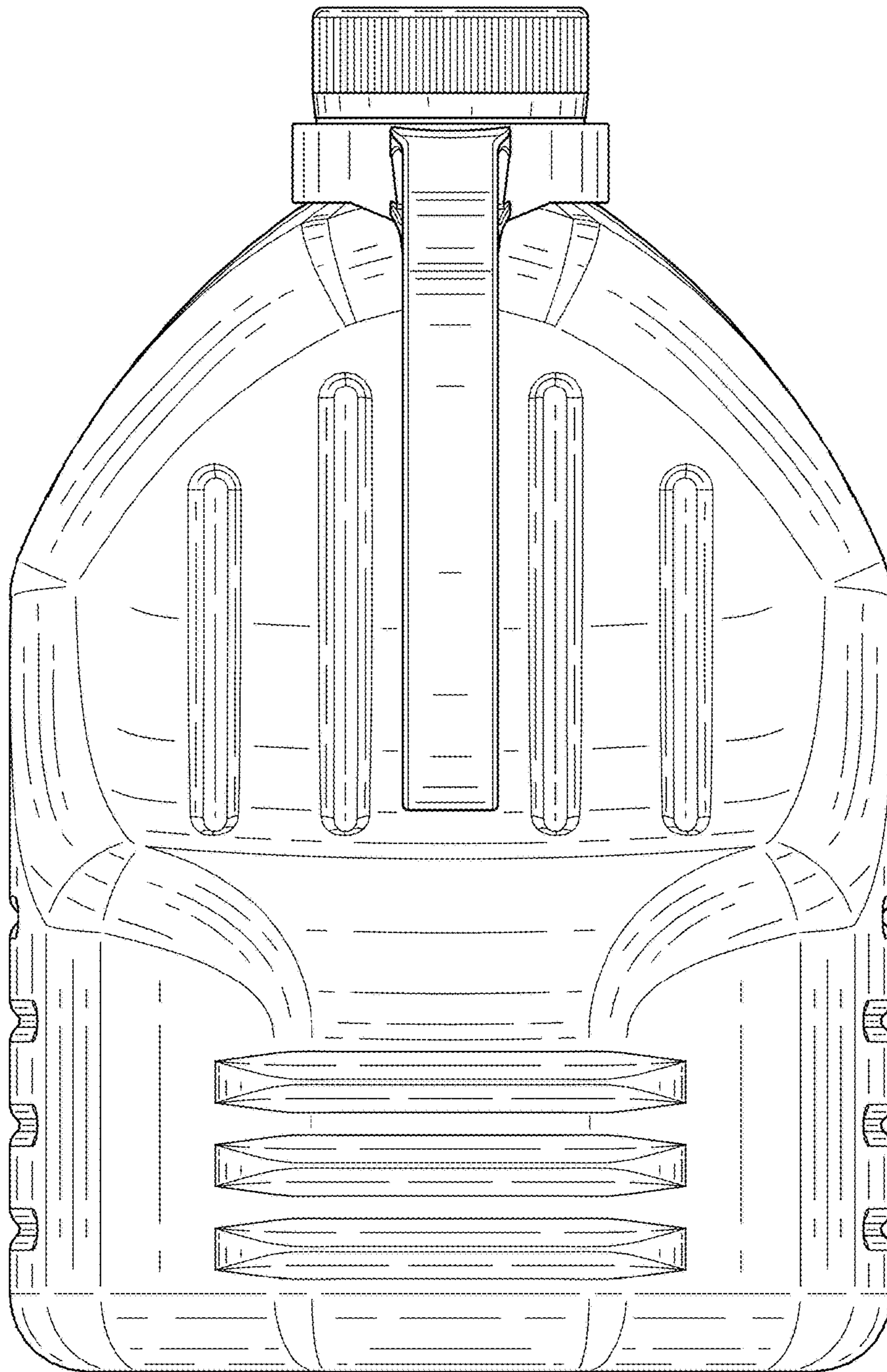

FIG. 7

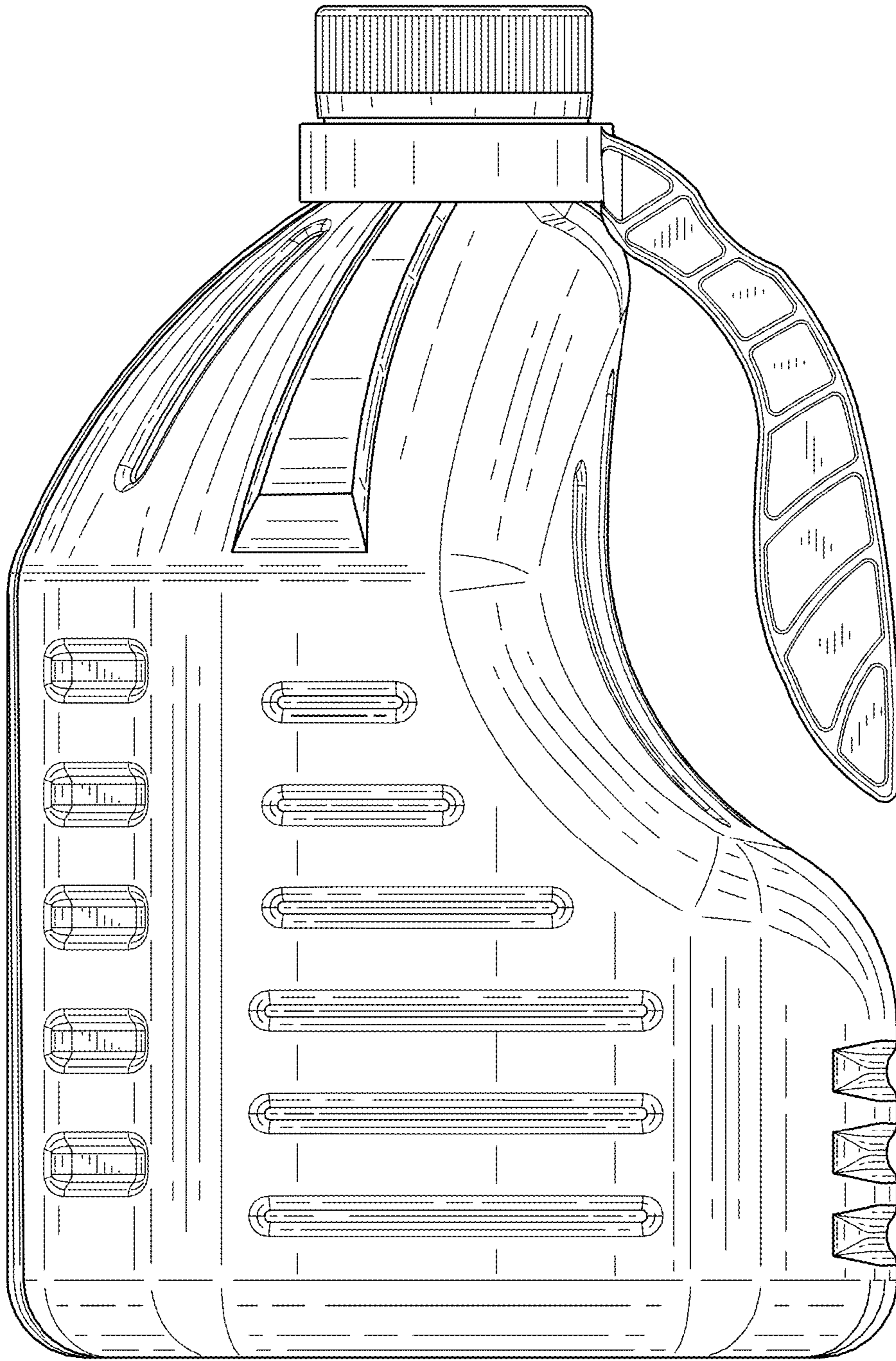

FIG. 8

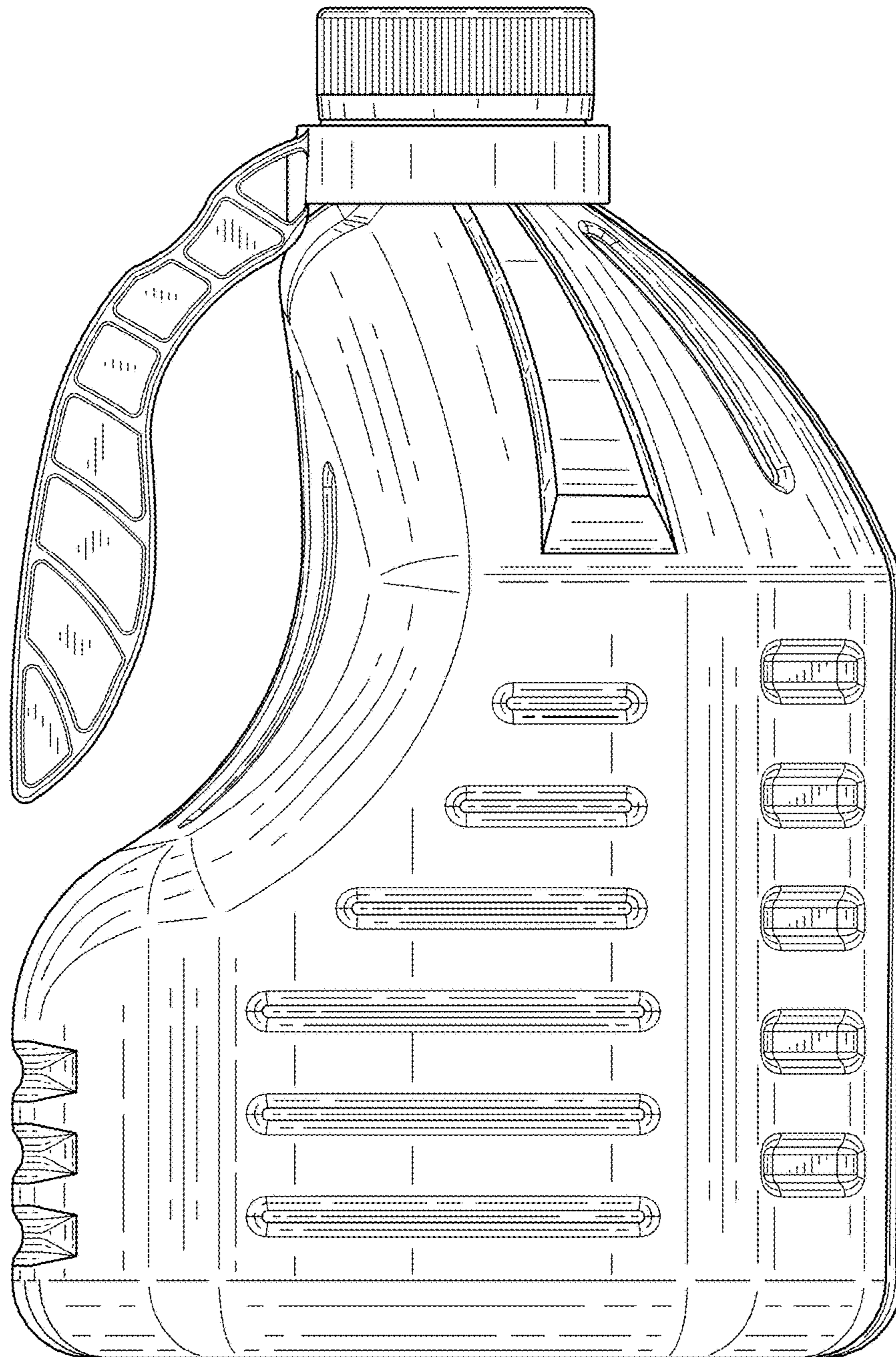

FIG. 9

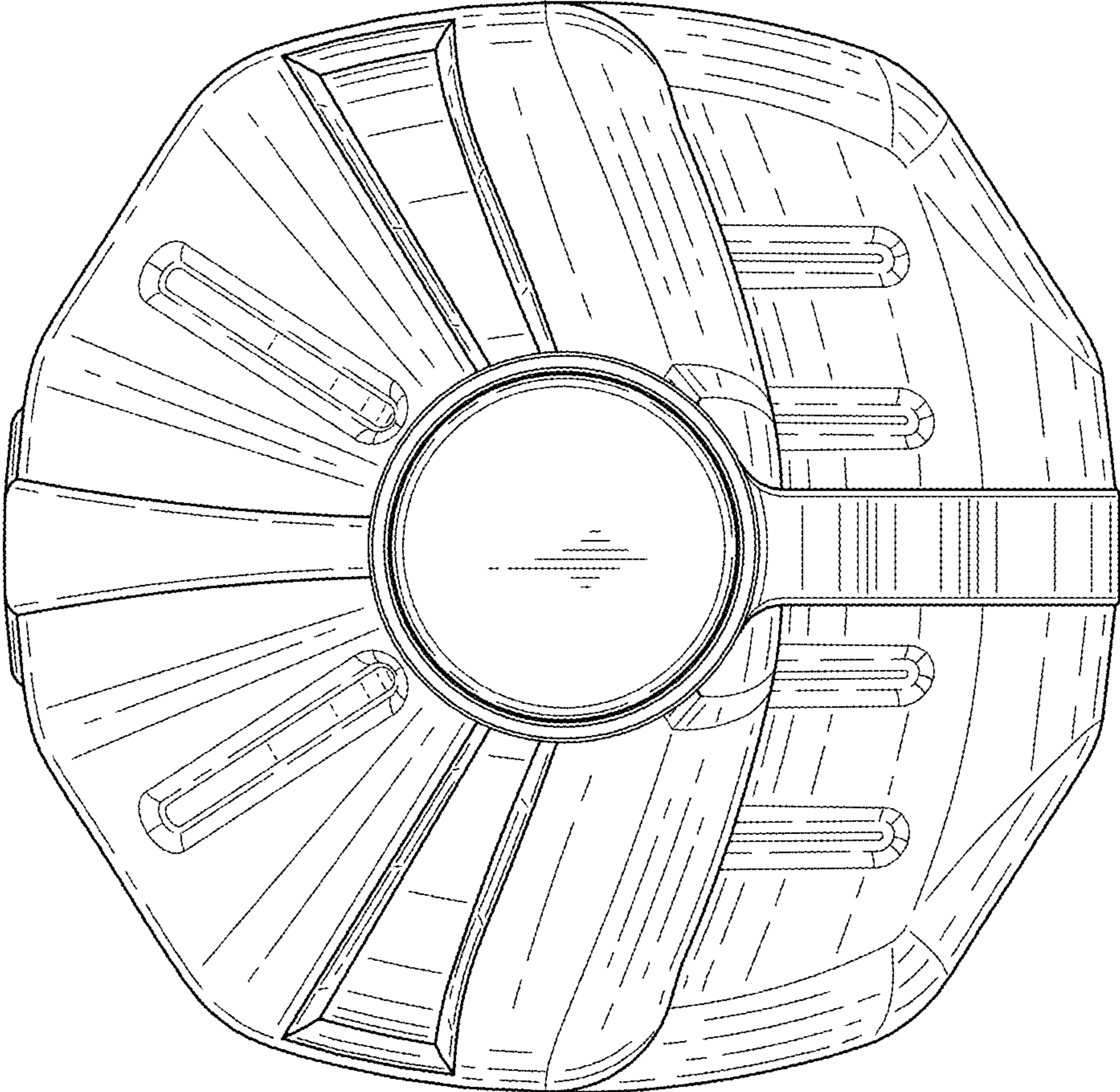

FIG. 10

