

US00D840233S

(12) **United States Design Patent** (10) **Patent No.:** **US D840,233 S**  
**Laib et al.** (45) **Date of Patent:** **\*\* Feb. 12, 2019**

(54) **PACKAGE**  
 (71) Applicant: **Owens-Brockway Glass Container Inc.**, Perrysburg, OH (US)  
 (72) Inventors: **Douglas Laib**, Perrysburg, OH (US); **Young Lee**, Perrysburg, OH (US)

D283,595 S 4/1986 Fortuna et al.  
 D283,677 S 5/1986 Fortuna et al.  
 4,665,682 A 5/1987 Kerins et al.  
 D321,477 S 11/1991 Gunter  
 5,269,437 A 12/1993 Gygax  
 (Continued)

(73) Assignee: **Owens-Brockway Glass Container Inc.**, Perrysburg, OH (US)

FOREIGN PATENT DOCUMENTS

CN 302975926 10/2014  
 CN 303237594 6/2015

(\*\*) Term: **15 Years**

*Primary Examiner* — Anhdao Doan  
*Assistant Examiner* — Mary Shannon Malley

(21) Appl. No.: **29/622,253**

(57) **CLAIM**

(22) Filed: **Oct. 16, 2017**

We claim an ornamental design for a package, as shown and described.

**Related U.S. Application Data**

**DESCRIPTION**

(63) Continuation of application No. 29/551,738, filed on Jan. 15, 2016.

(51) **LOC (11) Cl.** ..... **09-01**

(52) **U.S. Cl.**  
USPC ..... **D9/503**; D9/549; D9/454

(58) **Field of Classification Search**  
USPC ..... D9/453, 500–505, 516, 529, 530, 533, D9/537, 538, 541, 546, 549–559, 569, D9/570, 690, 694, 738, 454, 428, 691, D9/429; D7/602, 612, 615; D28/76, 82; 215/379, 382

CPC ... B65D 1/00; B65D 1/02; B65D 1/07; B65D 1/0023; B65D 1/10; B65D 23/00; B65D 2501/00; B65D 2501/0009; B65D 1/40; B65D 1/0246; B65D 1/0253

See application file for complete search history.

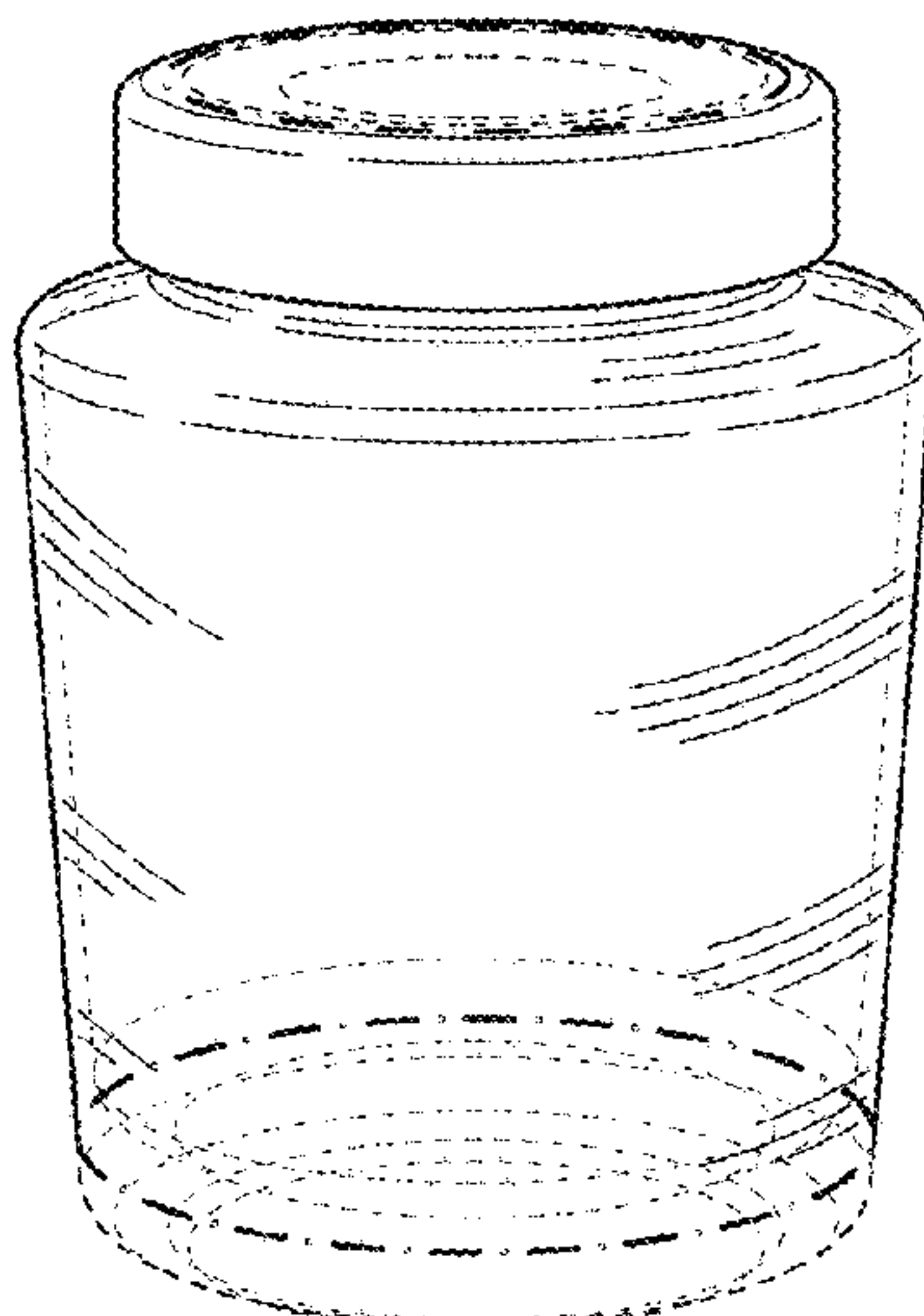
FIG. 1 is a perspective view of a package in accordance with an embodiment of our new claimed design.  
 FIG. 2 is a front side view of the package in FIG. 1.  
 FIG. 3 is a right side view of the package in FIG. 1.  
 FIG. 4 is a rear side view of the package in FIG. 1.  
 FIG. 5 is a left side view of the package in FIG. 1.  
 FIG. 6 is a top view of the package in FIG. 1.  
 FIG. 7 is a bottom view of the package in FIG. 1.  
 FIG. 8 is a perspective view of a package in accordance with another embodiment of our new claimed design.  
 FIG. 9 is a front side view of the package in FIG. 8.  
 FIG. 10 is a right side view of the package in FIG. 8.  
 FIG. 11 is a rear side view of the package in FIG. 8.  
 FIG. 12 is a left side view of the package in FIG. 8.  
 FIG. 13 is a top view of the package in FIG. 8; and, FIG. 14 is a bottom view of the package in FIG. 8.  
 The dash-dash-dash broken lines show the portion of the package that are not part of the claimed design.  
 Dash-dot-dash broken lines shown in the drawings represent boundaries of the claimed design and are not part of the claimed design.

(56) **References Cited**

U.S. PATENT DOCUMENTS

D266,485 S 10/1982 Guerette  
 D272,508 S 2/1984 Conti  
 D279,651 S 7/1985 Freeman  
 D283,594 S 4/1986 MacLaughlin et al.

**1 Claim, 4 Drawing Sheets**



(56)

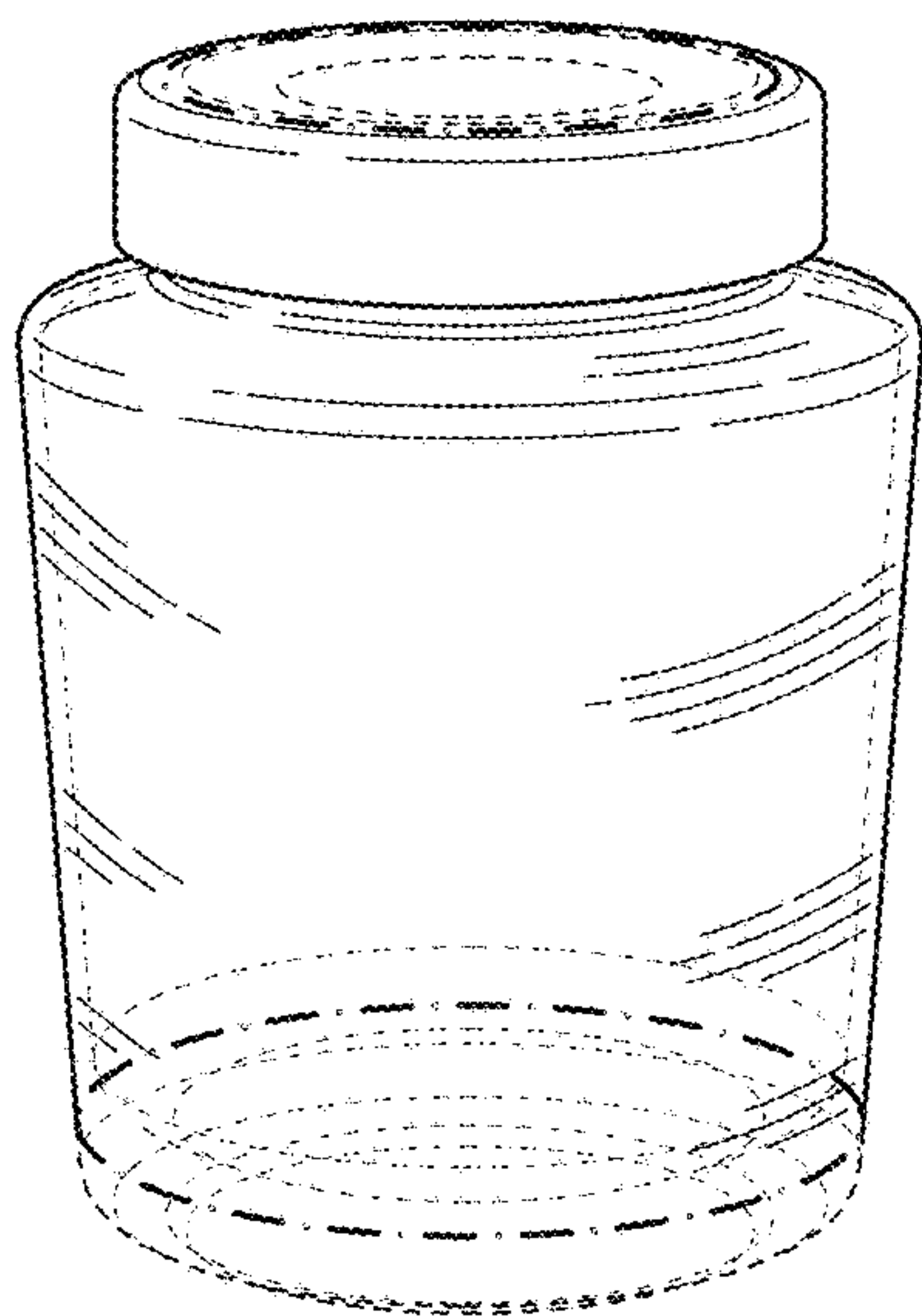
**References Cited**

U.S. PATENT DOCUMENTS

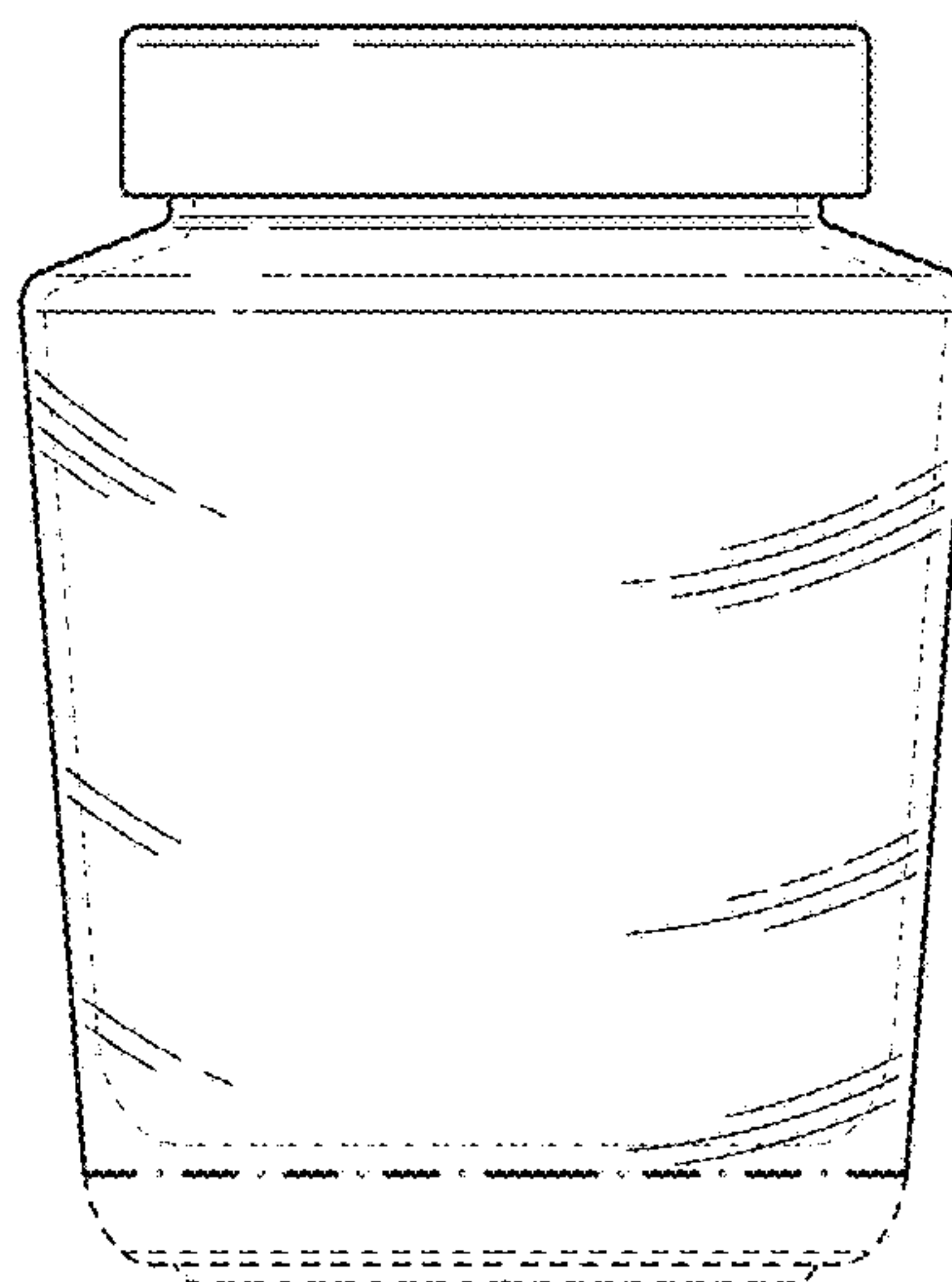
D355,605 S 2/1995 Kudo et al.  
 D412,440 S 8/1999 Chuang  
 D419,452 S 1/2000 DeVore  
 D435,449 S 12/2000 Moretti  
 D443,821 S 6/2001 Bakic  
 D474,978 S 5/2003 Varlet  
 D495,608 S 9/2004 Klemm et al.  
 D536,976 S 2/2007 Ciulla et al.  
 D542,143 S \* 5/2007 Phillips ..... D9/557  
 D554,519 S 11/2007 Varlet  
 D577,294 S \* 9/2008 Suxdorf ..... D9/504  
 D592,510 S 5/2009 Dali'Orto  
 D596,505 S 7/2009 Diss et al.  
 D596,958 S 7/2009 Diss et al.  
 D606,402 S 12/2009 Diss  
 D606,403 S 12/2009 Diss  
 D607,329 S 1/2010 Diss  
 D607,330 S 1/2010 Diss  
 D610,875 S 3/2010 Wingfield et al.  
 D616,749 S 6/2010 Tiveill et al.  
 D619,013 S 7/2010 Potts  
 D626,414 S 11/2010 Cresswell et al.  
 D633,794 S 3/2011 Cresswell et al.

D633,795 S 3/2011 Cresswell et al.  
 D633,796 S 3/2011 Cresswell et al.  
 D638,709 S 5/2011 Yourist  
 D645,746 S 9/2011 Yu  
 D657,245 S 4/2012 Delbon  
 D659,004 S 5/2012 McCoy  
 D672,655 S 12/2012 Huffman et al.  
 D677,569 S 3/2013 Lemaitre  
 D680,443 S \* 4/2013 You ..... D9/691  
 D694,112 S 11/2013 Brown  
 D696,120 S \* 12/2013 You ..... D9/454  
 D697,805 S \* 1/2014 You ..... D9/454  
 D700,517 S 3/2014 Oommen et al.  
 D703,057 S 4/2014 Moore et al.  
 D713,258 S 9/2014 Del Bon  
 D722,273 S 2/2015 Ivie  
 D730,189 S 5/2015 Haile  
 D734,155 S 7/2015 Moore et al.  
 D734,671 S 7/2015 Herbst  
 D743,796 S \* 11/2015 Pratt ..... D9/500  
 D756,716 S 5/2016 Hewitt et al.  
 D765,509 S 9/2016 Laib et al.  
 D765,510 S 9/2016 Laib et al.  
 D802,422 S \* 11/2017 Laib ..... D9/500  
 2012/0152882 A1 6/2012 Tune

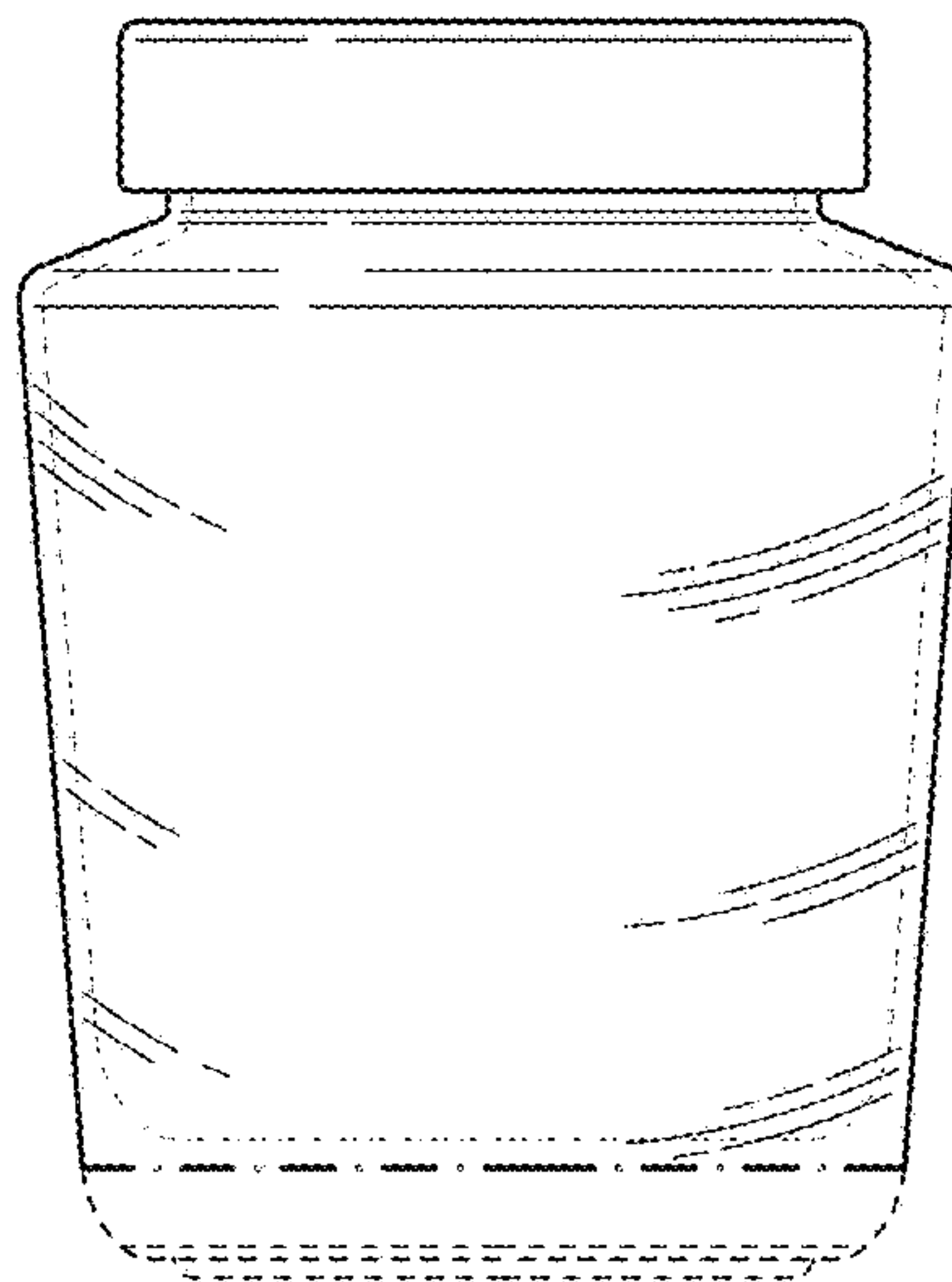
\* cited by examiner



**FIG. 1**

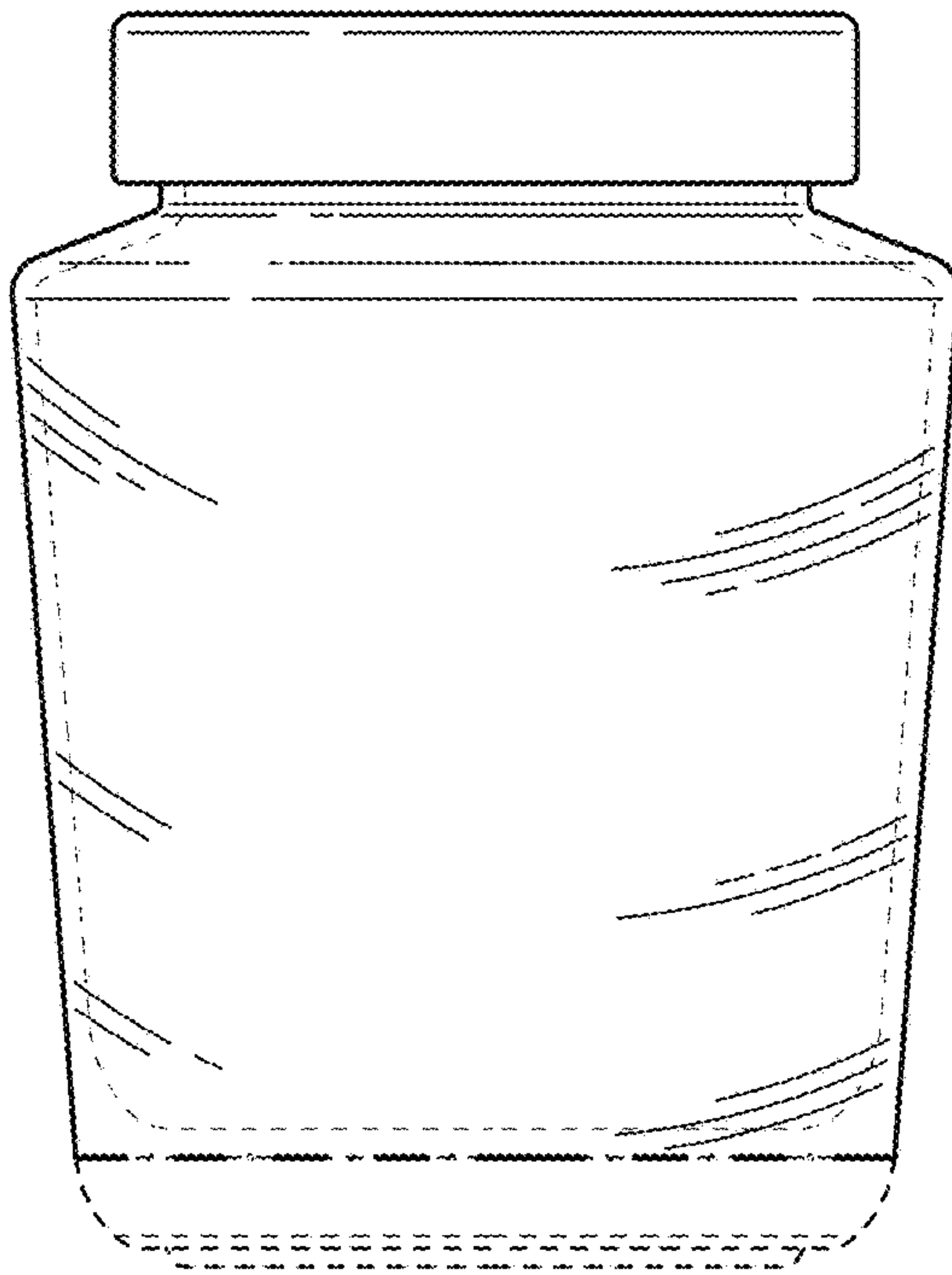


**FIG. 2**

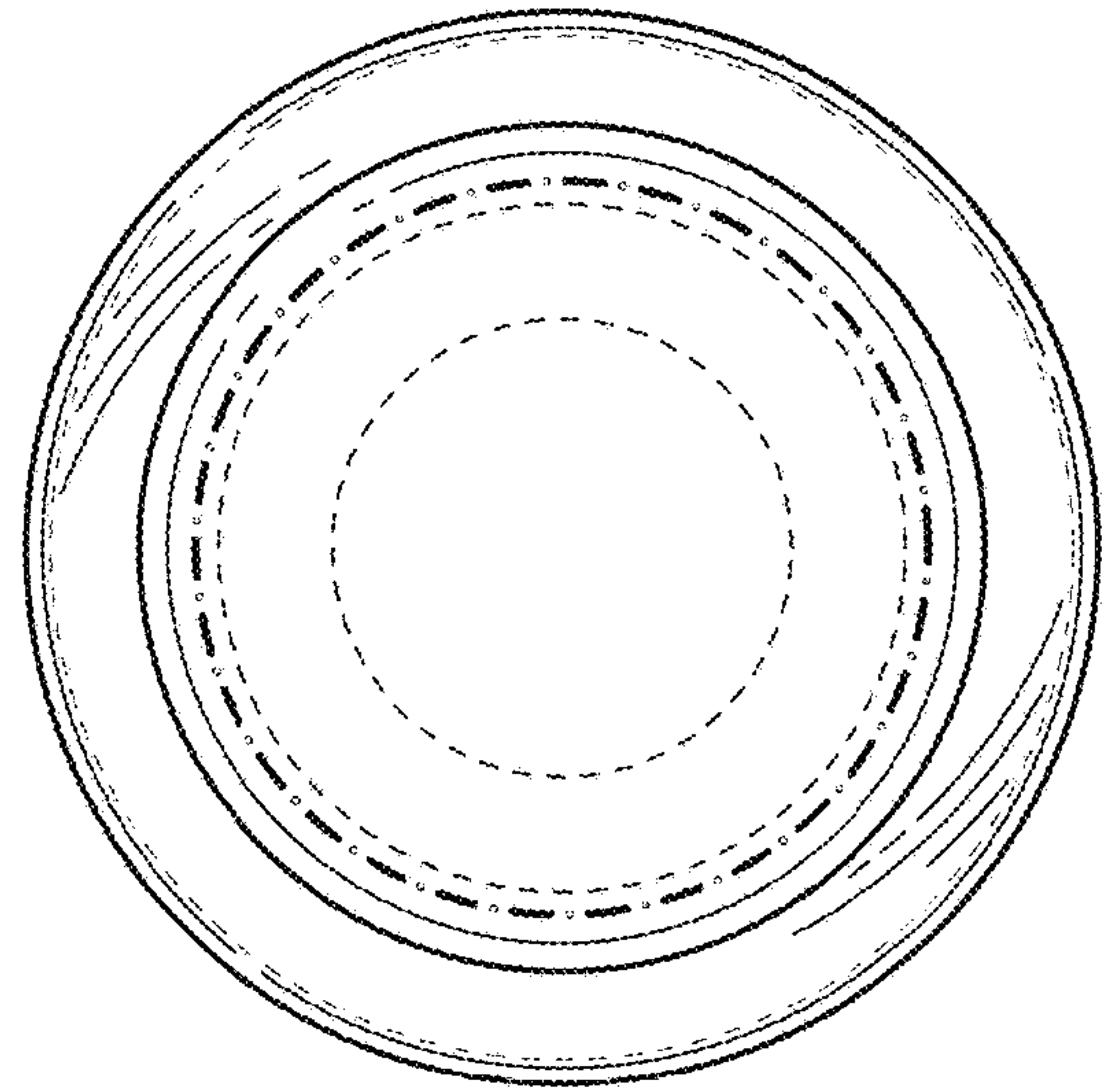


**FIG. 3**

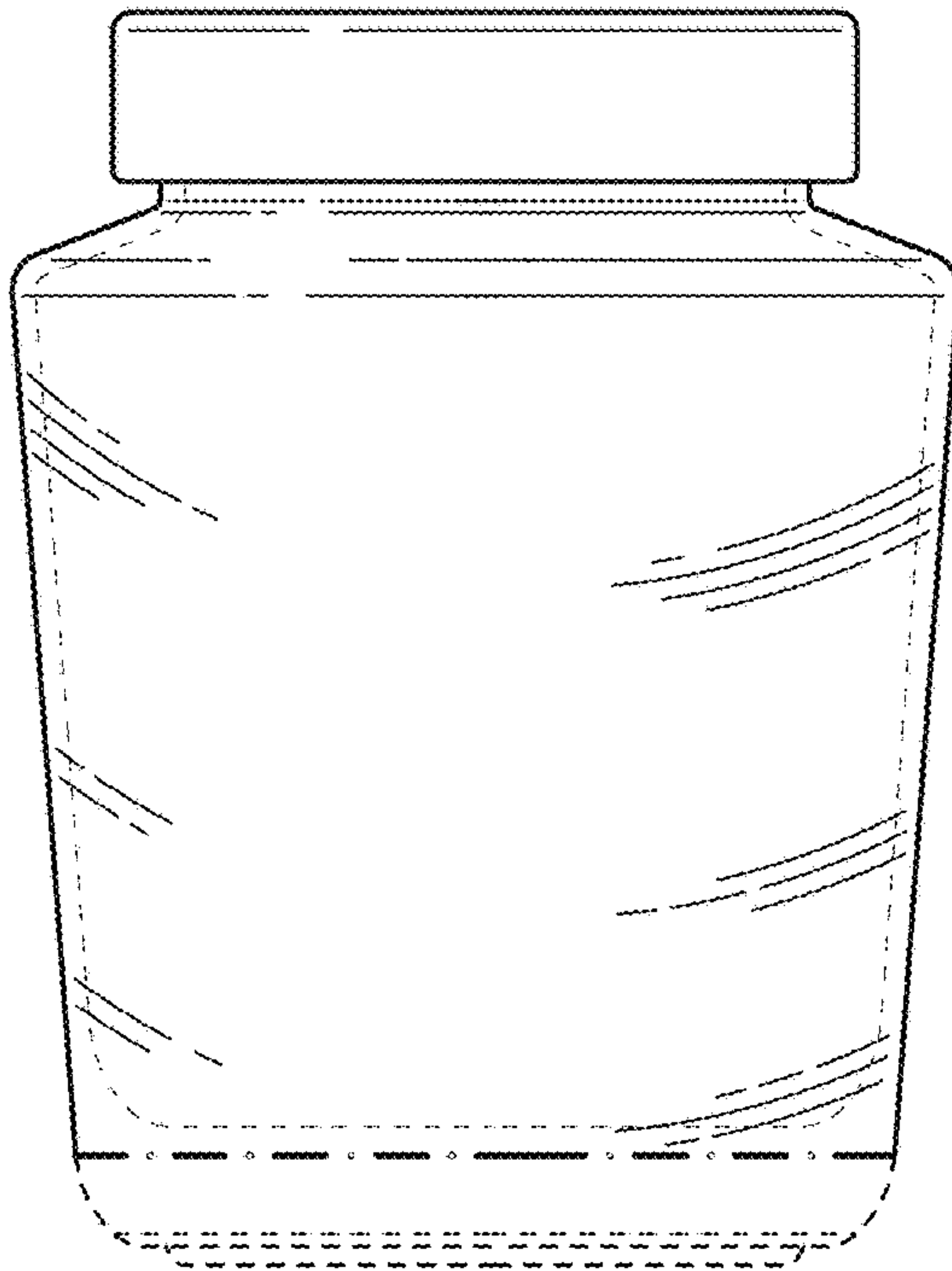




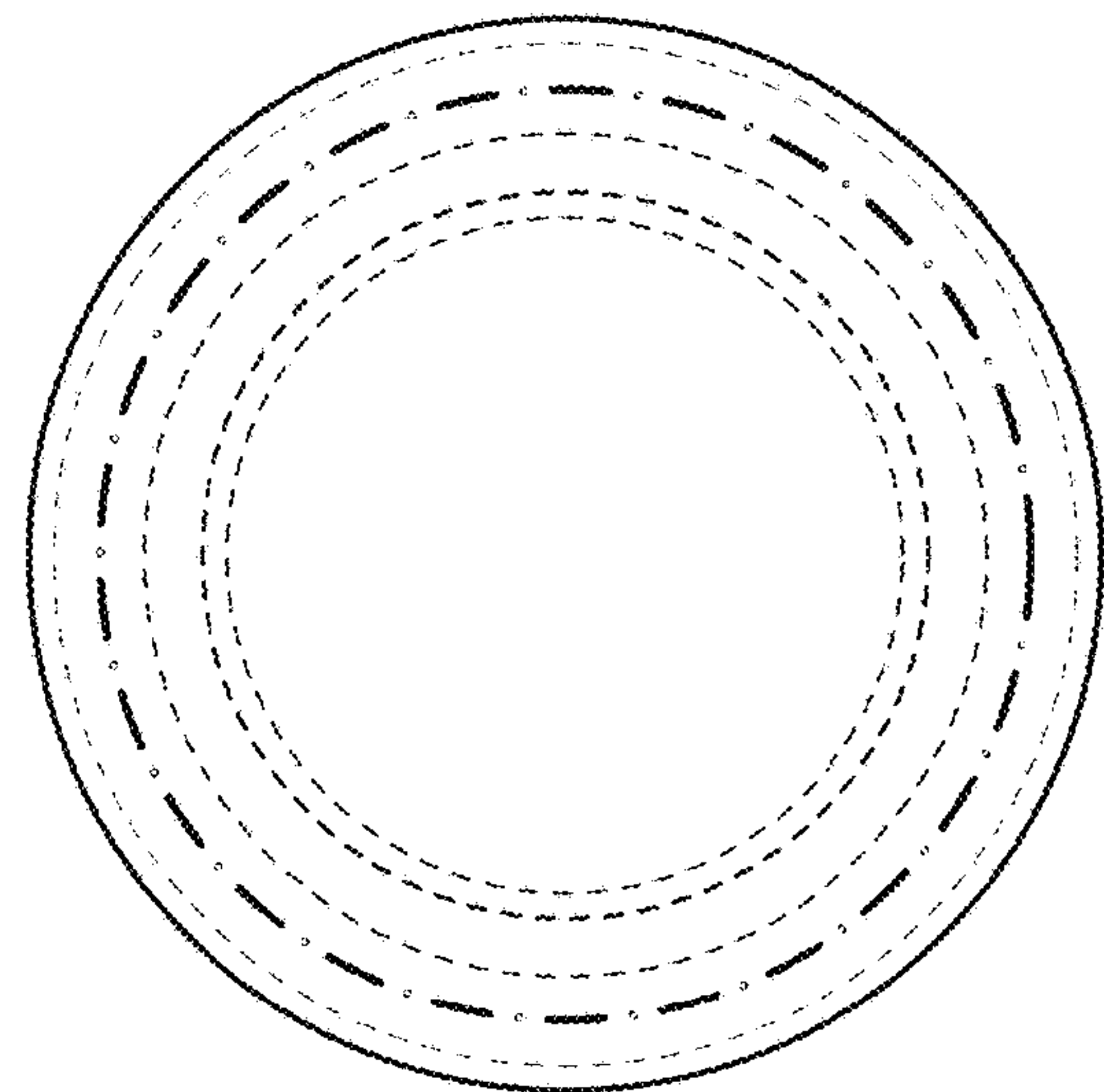
**FIG. 4**



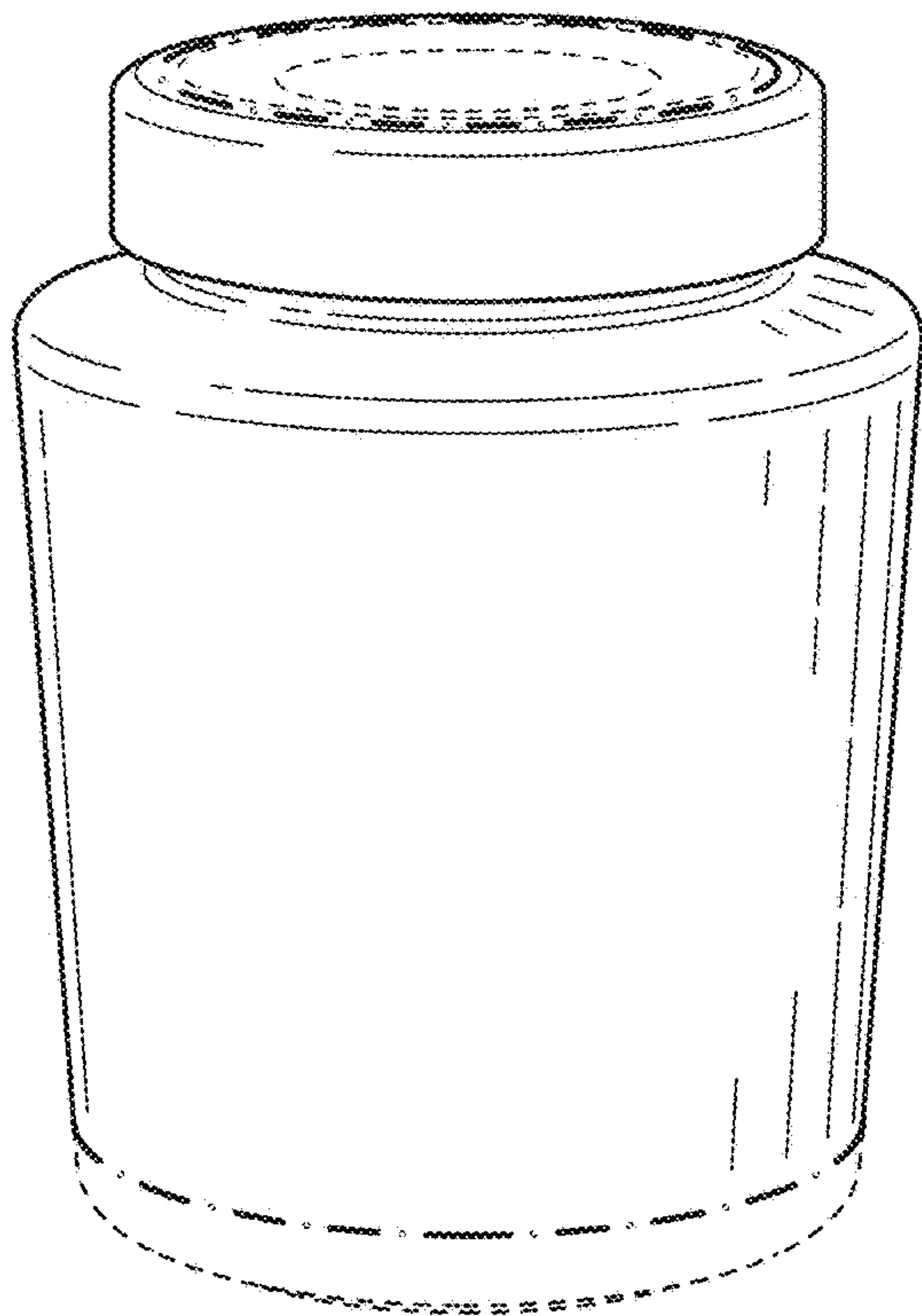
**FIG. 6**



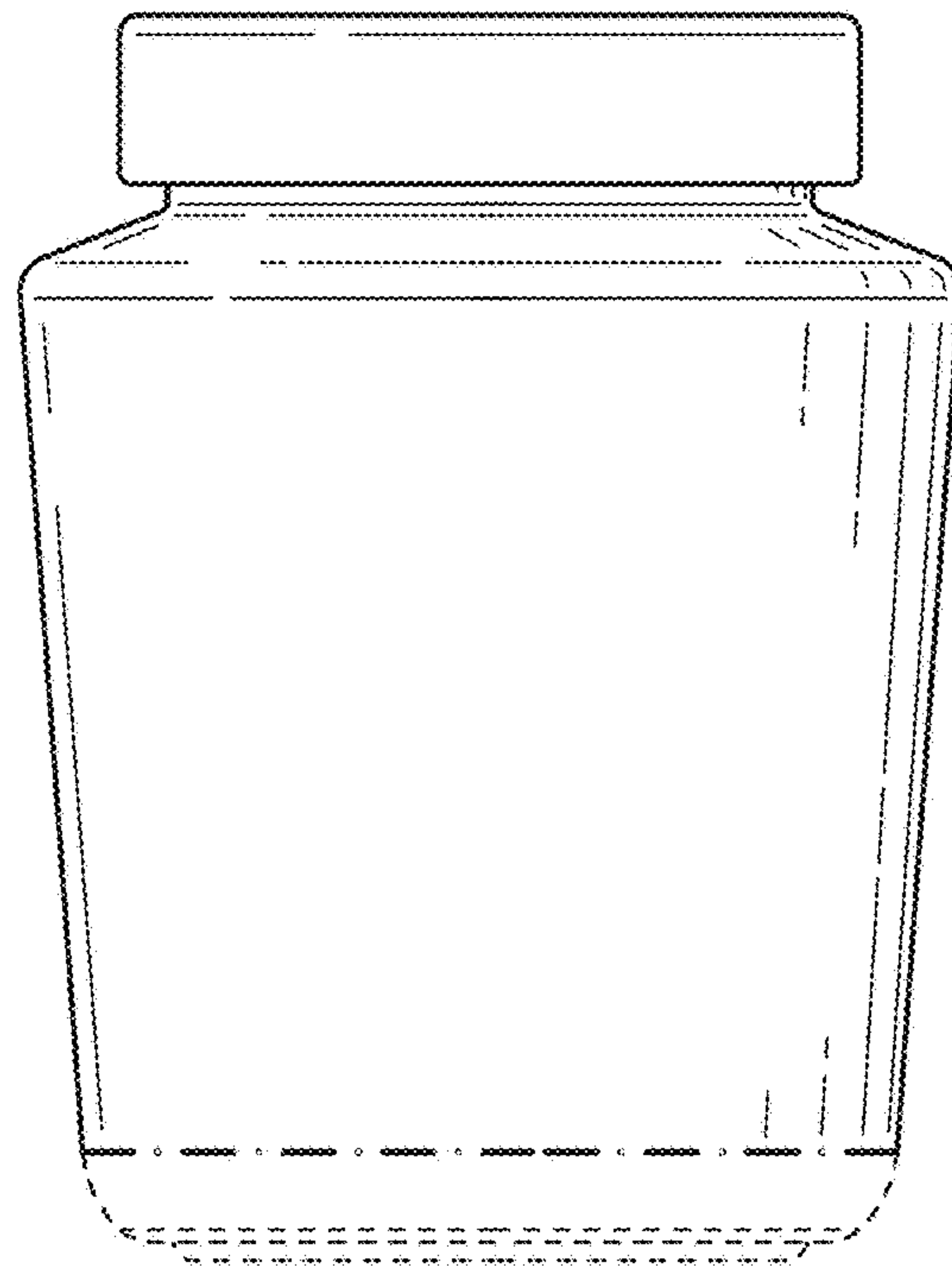
**FIG. 5**



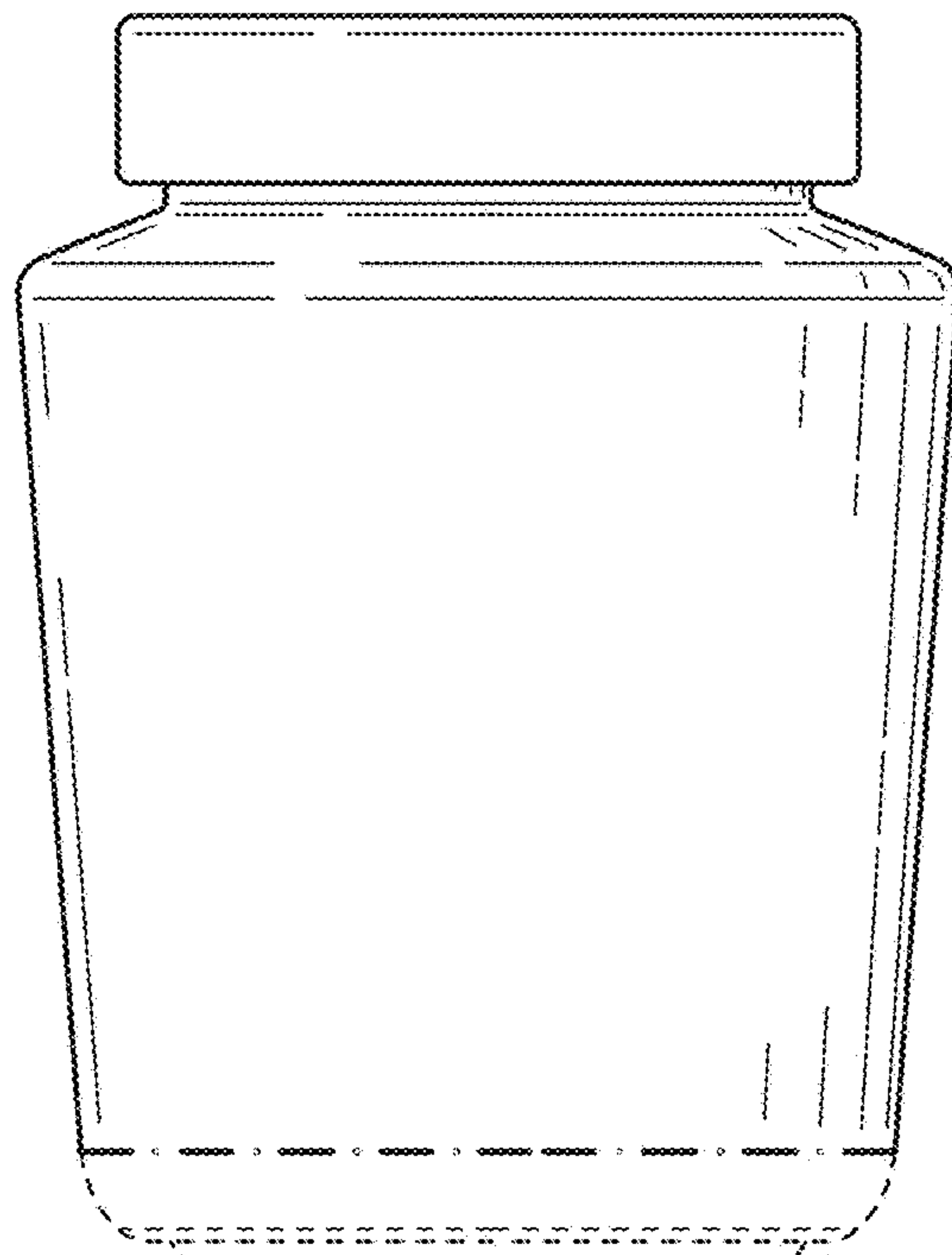
**FIG. 7**



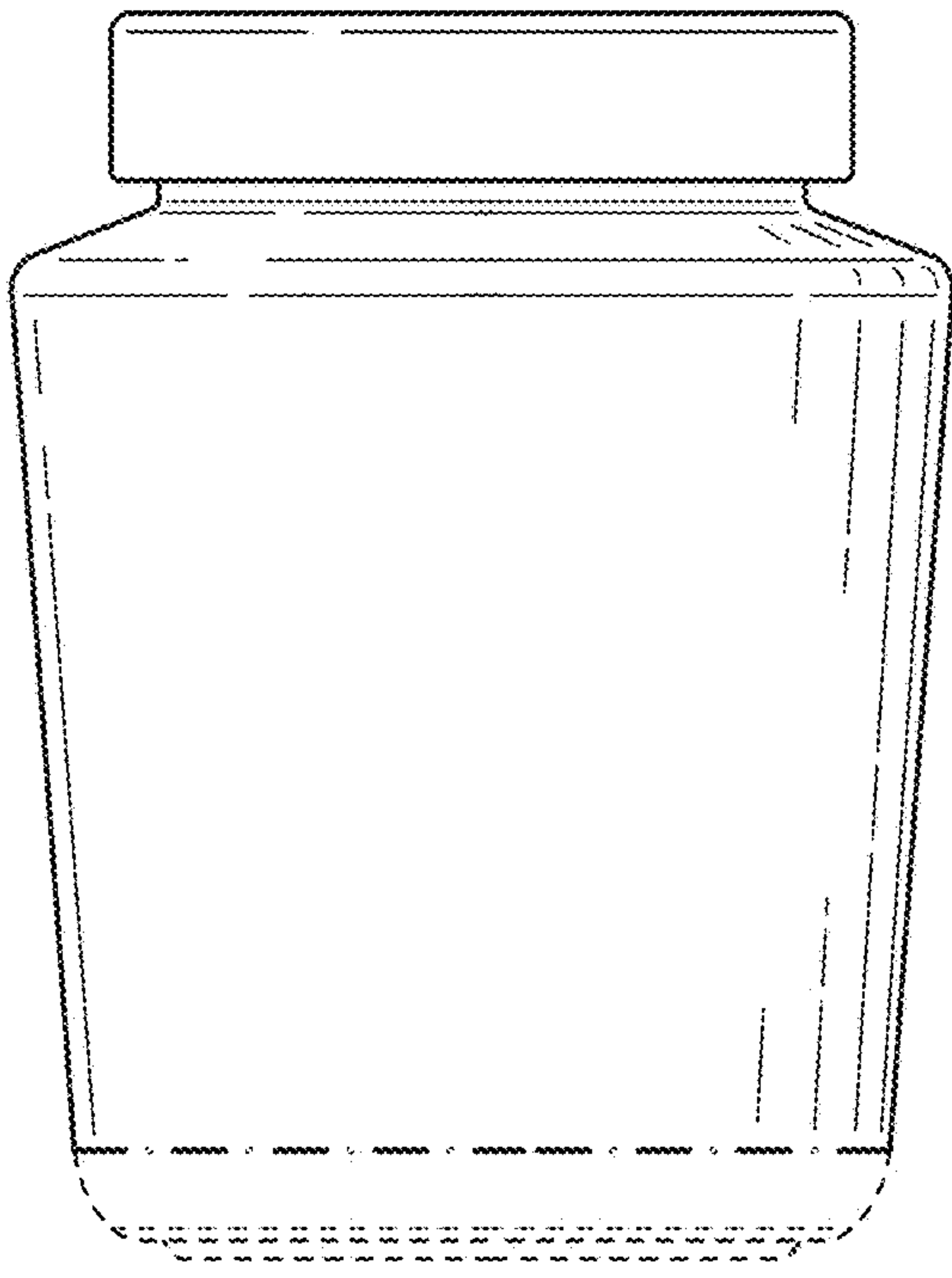
**FIG. 8**



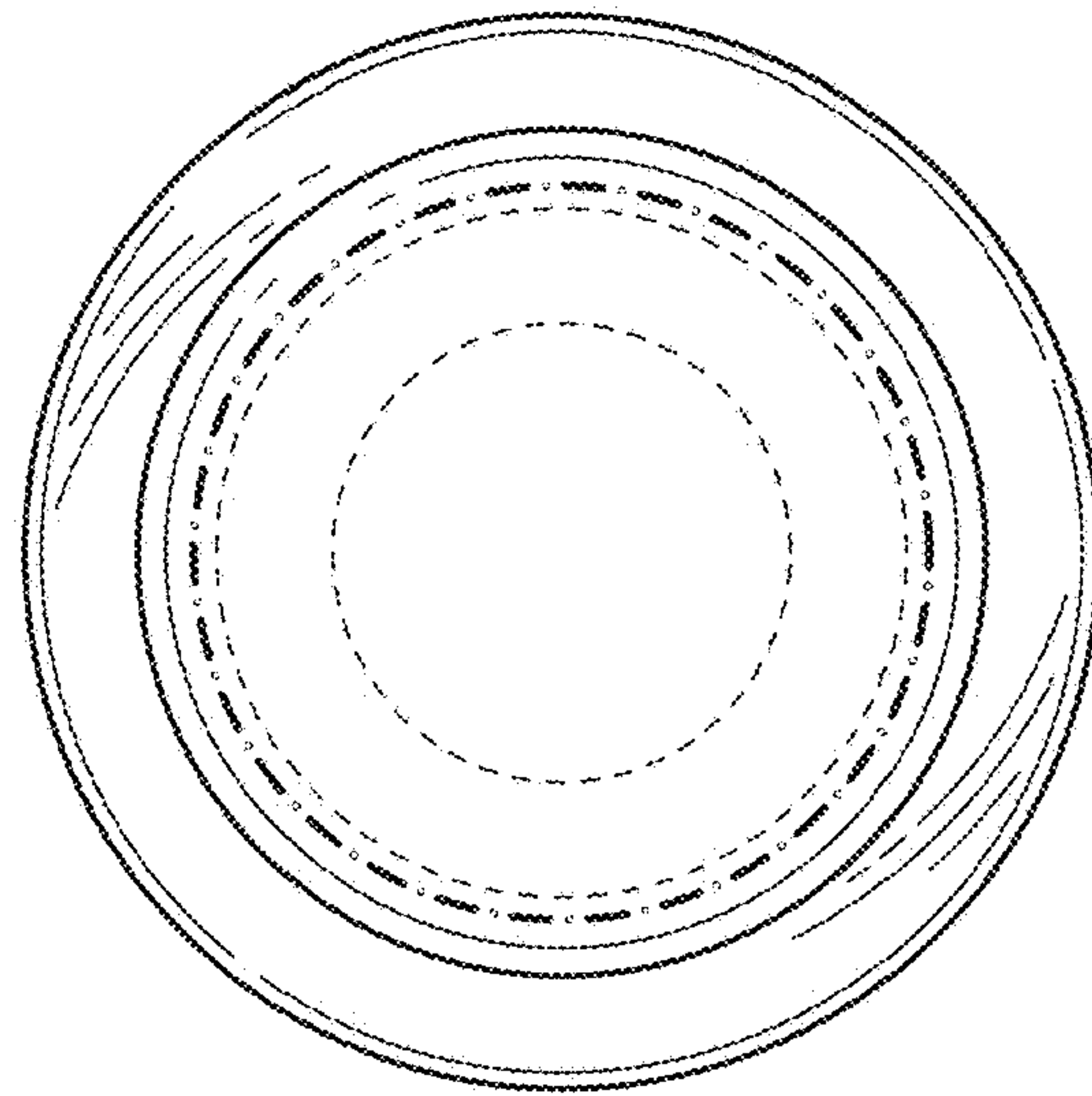
**FIG. 9**



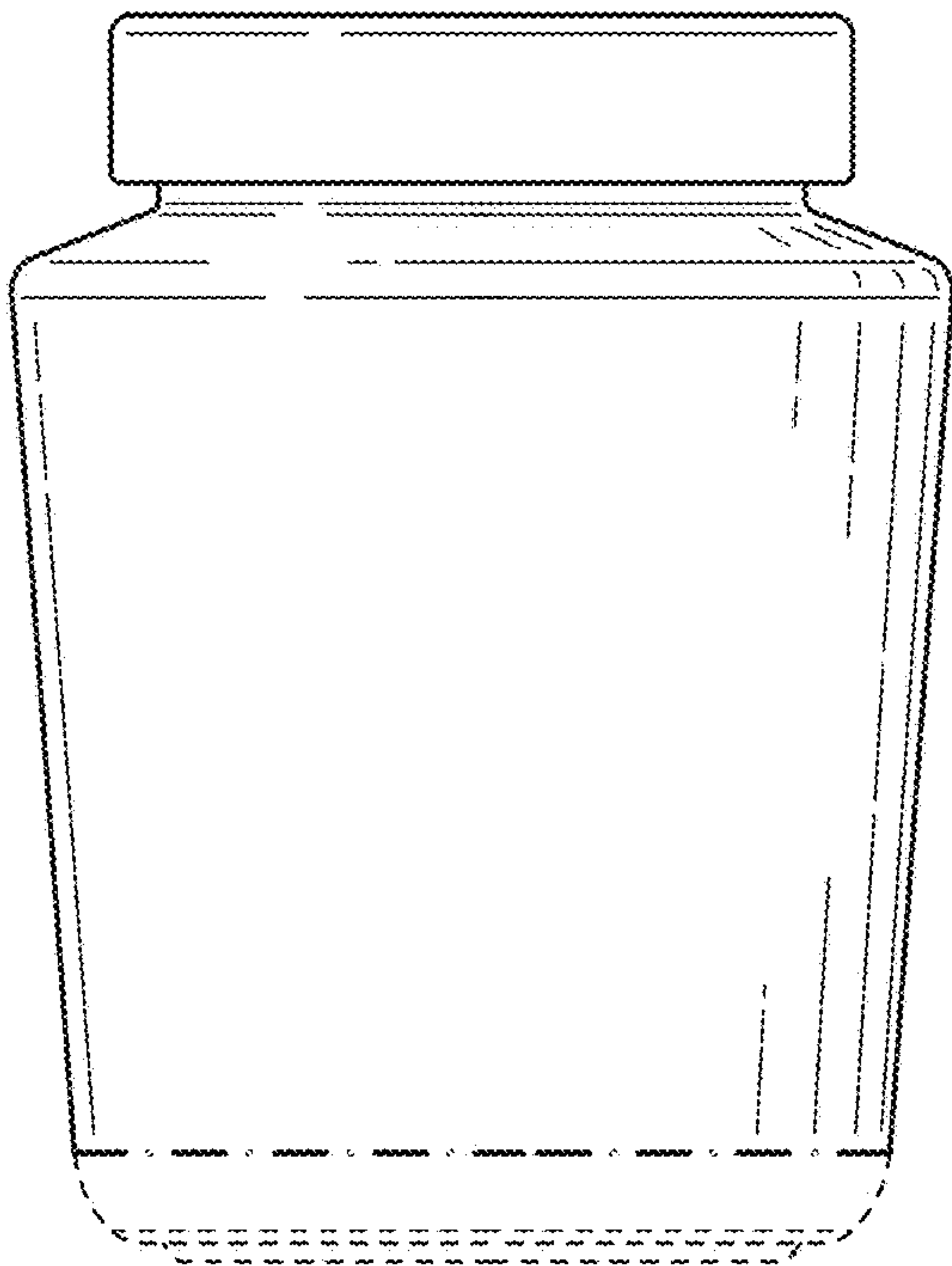
**FIG. 10**



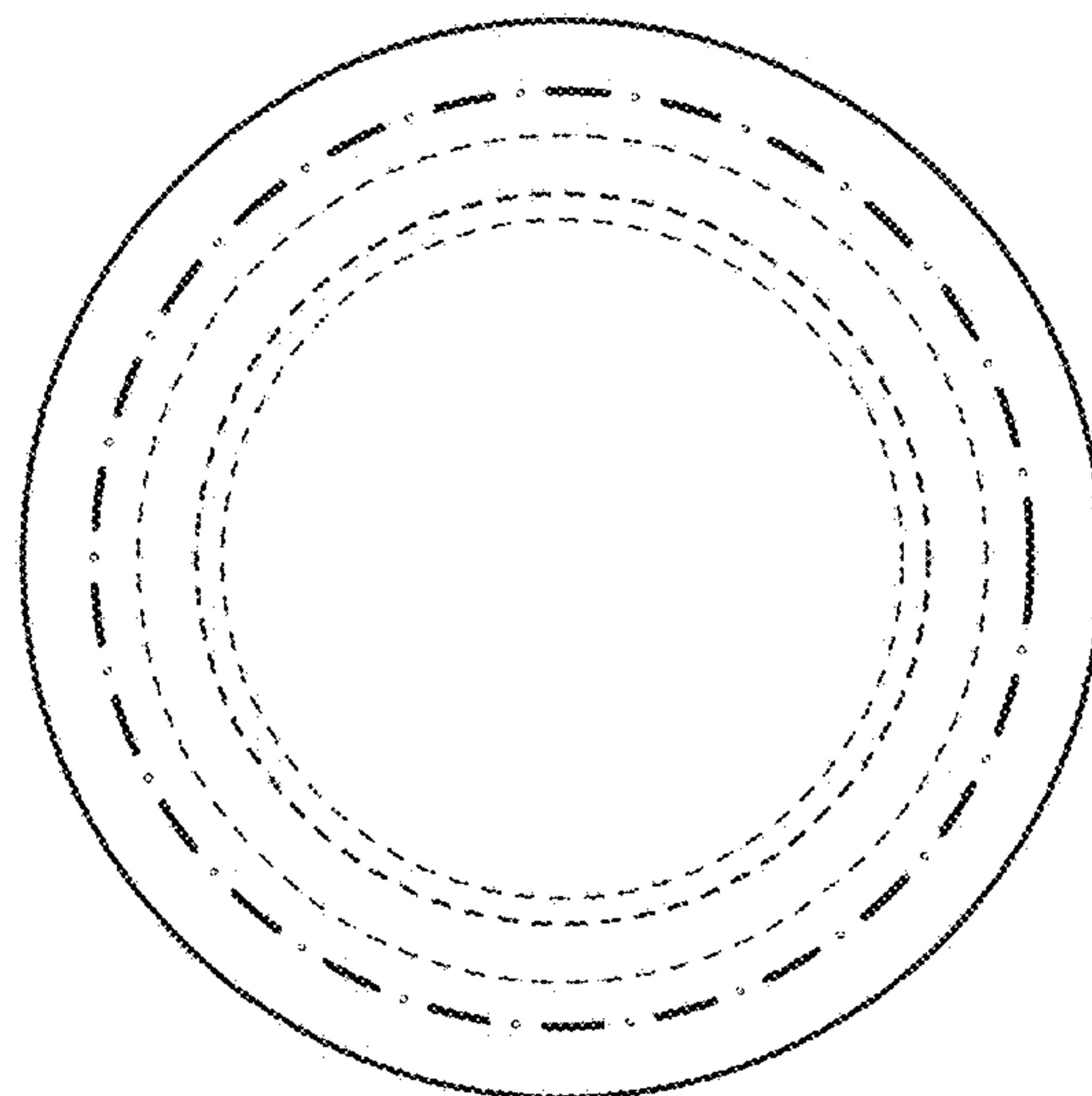
**FIG. 11**



**FIG. 13**



**FIG. 12**



**FIG. 14**