



US00D840232S

(12) **United States Design Patent**
Sill et al.

(10) **Patent No.:** **US D840,232 S**

(45) **Date of Patent:** **** Feb. 12, 2019**

(54) **COMPARTMENTED CARTON INSERT**

(71) Applicant: **Inno-Pak, LLC**, Delaware, OH (US)

(72) Inventors: **Jonathan D. Sill**, Powell, OH (US);
Steven A. Mayer, Indianapolis, IN (US)

(73) Assignee: **Inno-Pak, LLC**, Delaware, OH (US)

(**) Term: **15 Years**

(21) Appl. No.: **29/582,402**

(22) Filed: **Oct. 27, 2016**

(51) **LOC (11) Cl.** **09-07**

(52) **U.S. Cl.**
USPC **D9/456**

(58) **Field of Classification Search**

USPC D3/20, 200, 201, 272, 273, 295, 304,
D3/309-315, 318, 319, 901, 903, 904;
D6/515-525, 532, 536, 672, 677, 683,
D6/704, 707.15; D7/323, 339, 347, 354,
D7/355, 356, 359, 360, 362, 392.1, 396.1,
D7/412, 500, 505, 549, 550.1, 552.1,
D7/552.2, 553.1, 553.2, 553.4, 553.5,
D7/553.6, 553.7, 554.1, 555, 600.1, 601,
D7/602, 614, 615; D9/414, 415, 416,
D9/418, 428-430, 500, 630, 682, 686,
D9/688, 690, 692, 703, 737, 738, 740,
D9/744, 755-762, 904, 434, 455, 456;
D12/163, 197, 415, 425; D19/1, 27, 78,
D19/102, 103, 106, 107; D21/502, 524,
D21/525, 532, 832; D24/127, 128, 216,
D24/224, 227, 228, 229, 230; D28/61,
D28/73, 76; D32/55, 58; D30/121, 129,
D30/130, 131
CPC A47C 7/70; A47C 7/62; B65D 1/36; B65D
1/243; B65D 25/22; B65D 77/00; B65D
77/20; B65D 77/2024; B65D 77/225;
B65D 77/245; B65D 1/00; B65D 1/02;
B65D 1/0232; B65D 1/22; B65D 1/32;
B65D 1/34; B65D 1/40; B65D 1/225;
B65D 2543/00194; B65D 2543/00296;

B65D 2543/00629; B65D 2543/0074;
B65D 2543/00842; B65D 85/36; B65D
81/025; B65D 81/18; B65D 81/3407;
B65D 81/3438; B65D 81/3846; B65D
81/3865; B65D 21/00; B65D 21/0204;
B65D 21/0209; B65D 2585/6897; B65D
5/18; B65D 5/2047; A47G 23/00; A47G
23/06; A47G 23/0225; A47G 21/001;
A47G 19/00; A47G 19/02; A45C 11/20;
B60N 3/106; A23V 2002/00; A47J
45/061; A47J 45/065; A47J 45/071; A47J
45/08; A47J 43/00; A47J 37/00; A47J
37/01; A47J 37/04; A47J 37/06; A47J
37/10; A47J 37/12; A47J 37/101; A47J
37/103; A47J 37/108; A47J 37/1204;
A47J 37/0704; H05B 6/06; H05B 6/12;
A23L 5/15; A23L 13/00; A47B 37/60;
A23B 5/00; A23B 5/005; A23B 5/0052

See application file for complete search history.

(56)

References Cited

U.S. PATENT DOCUMENTS

D73,127 S 7/1927 Greve
2,019,870 A 11/1935 Perry
2,062,949 A 12/1936 Taylor
D106,826 S 11/1937 Dieffenbach
D126,123 S 3/1941 Clemens
2,409,736 A 10/1946 Caimi
D158,362 S 5/1950 Dischler
2,568,170 A 9/1951 Ringler
2,793,801 A 5/1957 Papadopoulos
D183,716 S 10/1958 Burns
D194,246 S 12/1962 Engelmann
D200,249 S * 2/1965 Hancock 206/521.1
D211,564 S 7/1968 Bailey
D212,495 S * 10/1968 Stageberg D7/553.3
D214,523 S 6/1969 Stone
D217,441 S 5/1970 Kanaga
D219,263 S 11/1970 Castelli
3,595,425 A * 7/1971 Eicholtz B65D 1/36
206/511
D224,090 S 7/1972 Cyr
D232,524 S 8/1974 Schy
3,853,220 A 12/1974 Luray
D241,016 S 8/1976 Reynold
D255,011 S 5/1980 Cooper
D259,615 S 6/1981 Morris, Jr.

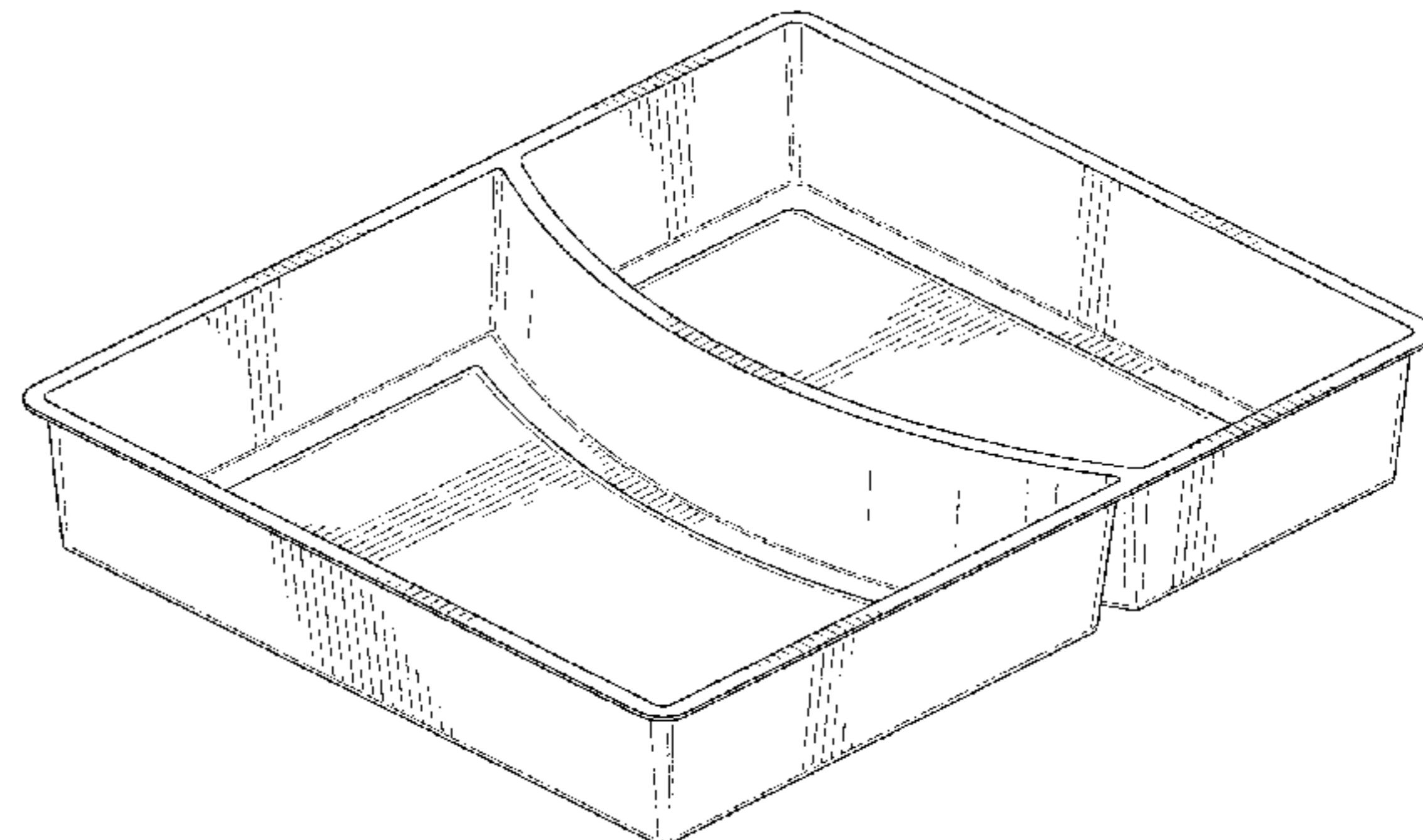
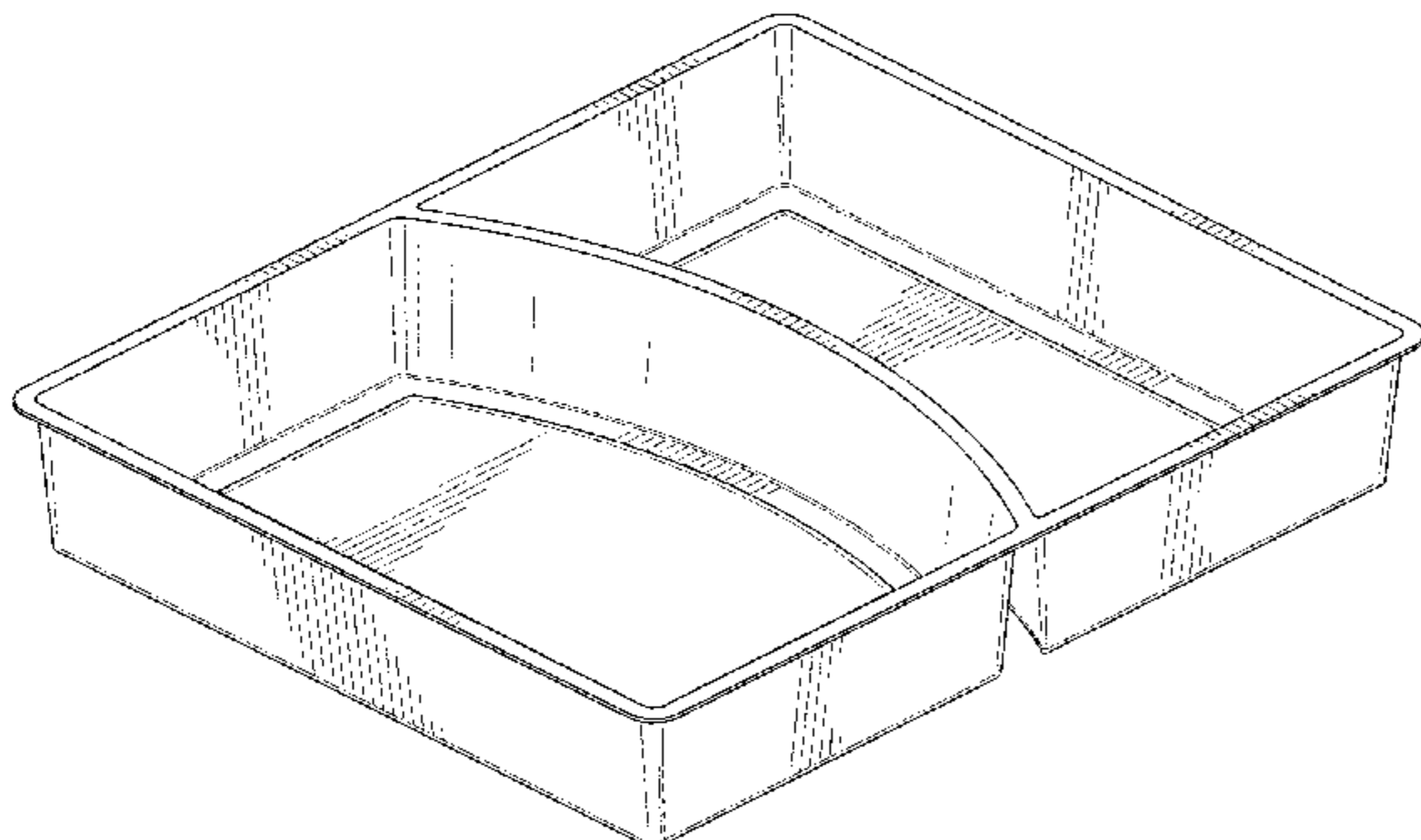

US D840,232 S

D260,604 S	9/1981	Otto		D652,316 S	1/2012	Ren	
D280,290 S	8/1985	Bakus		D653,496 S	2/2012	Henry	
D329,376 S	9/1992	Burd		D665,628 S *	8/2012	Mayer	D7/553.2
5,322,182 A *	6/1994	Fritz	B65D 1/36	D669,352 S	10/2012	Paslawski	
			219/725	D674,690 S	1/2013	Sill	
D351,997 S *	11/1994	Finnah	D9/425	D675,092 S	1/2013	Sill	
D352,203 S *	11/1994	Campbell	D7/546	D675,520 S	2/2013	Sill	
5,411,204 A	5/1995	DeMay		D675,920 S	2/2013	Sill	
5,419,451 A	5/1995	Bitel, Jr.		D676,742 S	2/2013	Walter	
D363,856 S *	11/1995	Westbrooks, Jr.	D7/553.2	D678,760 S	3/2013	Cooper	
D367,172 S	2/1996	Brighbill et al.		D678,761 S	3/2013	Cooper	
D371,940 S	7/1996	Krupa		D678,762 S	3/2013	Cooper	
D376,953 S *	12/1996	Dunn	D7/549	D678,779 S	3/2013	Lee	
D394,385 S	5/1998	Laughlin		D679,950 S	4/2013	Cooper	
D395,547 S	6/1998	Sussman		D682,085 S	5/2013	Hannant	
D397,294 S	8/1998	Saulas		D682,684 S	5/2013	Walter	
D398,526 S	9/1998	Schwarz et al.		D684,465 S	6/2013	Vernon	
5,873,220 A	2/1999	Haraldson et al.		D684,858 S	6/2013	Sill	
D409,908 S	5/1999	Besana		D688,552 S	8/2013	Vernon	
2,927,502 A	7/1999	Hunter		D688,921 S	9/2013	Miros et al.	
D412,398 S	8/1999	Watabe		D691,035 S	10/2013	Sill	
D440,118 S	4/2001	Claffy		D693,180 S *	11/2013	Peterson	D7/555
D442,859 S	5/2001	Hirschey		D693,215 S	11/2013	Sill	
D444,703 S	7/2001	Allasia		D693,216 S	11/2013	Sill	
D448,130 S	9/2001	Wagner		D693,217 S	11/2013	Sill	
D451,769 S	12/2001	Stanos		D693,218 S	11/2013	Sill	
D454,495 S	3/2002	Bryan		D693,646 S *	11/2013	Katterheinrich	D7/555
D460,689 S	7/2002	Robinson		D693,679 S	11/2013	Sill	
D461,406 S	8/2002	Iacovelli		D695,101 S	12/2013	Keberlein	
D467,798 S	12/2002	Cohon		D695,104 S	12/2013	Sill	
D484,364 S	12/2003	Bailey et al.		D695,107 S	12/2013	Clements	
D484,799 S	1/2004	Hoffman		D695,575 S	12/2013	Katz	
D495,251 S	8/2004	Zack		D695,605 S	12/2013	Johnson	
D497,309 S	10/2004	Nordland		D697,789 S	1/2014	Gerdes	
D500,674 S *	1/2005	Chou	D9/425	D706,132 S	6/2014	Sill	
D504,813 S	5/2005	Chou		D707,042 S	6/2014	Ruzzenente	
D509,733 S	9/2005	Jongens		D707,123 S	6/2014	Marchetti	
D512,836 S	12/2005	Marnell		D710,691 S	8/2014	Genender	
D519,366 S	4/2006	Epstein		D712,153 S *	9/2014	Lee	D3/313
D519,830 S	5/2006	Yocum		D714,638 S	10/2014	Mohn	
D521,376 S	5/2006	Mosto		8,939,350 B2	1/2015	Valencia	
D521,862 S	5/2006	Siethoff		D726,533 S	4/2015	Northrup	
D531,498 S	11/2006	Fluegel		D727,732 S	4/2015	Petty	
D542,129 S	5/2007	Moorman		D728,359 S	5/2015	Iwegbu	
D549,456 S *	8/2007	Dretzka	D3/304	D728,364 S	5/2015	Baker	
D549,457 S *	8/2007	Dretzka	D3/304	D730,178 S	5/2015	Fullan	
D557,047 S *	12/2007	Dretzka	D3/304	D731,325 S	6/2015	Loessin	
D561,023 S	2/2008	Jacxsens		D735,576 S	8/2015	Aldridge	
D561,408 S	2/2008	Marsh		D737,820 S	9/2015	Yu	
D562,125 S	2/2008	Kienemund-Paroll		9,211,970 B2	12/2015	Hubbard, Jr.	
D563,673 S *	3/2008	Dretzka	D3/304	9,216,837 B2	12/2015	Hubbard	
D567,671 S	4/2008	Say Ulin		D746,643 S *	1/2016	Kraemer	D7/637
D568,765 S	5/2008	Miles		D752,429 S	3/2016	Mayer	
D573,408 S *	7/2008	Lovett	D7/553.2	9,309,023 B2	4/2016	Hubbard, Jr.	
D576,482 S	9/2008	DeBusk		D758,184 S	6/2016	Tu	
D578,387 S	10/2008	Lovett		D763,706 S	8/2016	Shum	
D582,268 S	12/2008	Zanaletti		D764,276 S	8/2016	Das et al.	
D584,108 S *	1/2009	Olsson	D7/553.1	D764,281 S	8/2016	Mayer	
D590,596 S *	4/2009	Dretzka	D3/304	D767,409 S	9/2016	Nickell	
D595,155 S	6/2009	Larson		D770,270 S *	11/2016	McGarry	D9/423
D596,027 S	7/2009	Kalberer		D771,486 S	11/2016	Mayer	
D596,448 S *	7/2009	Nolan	D7/354	D772,053 S	11/2016	Mayer	
D596,449 S *	7/2009	Nolan	D7/354	D775,946 S	1/2017	Ghini	
D596,903 S	7/2009	Willis		D777,029 S	1/2017	Stratton	
D599,611 S	9/2009	Hoekstra		D778,115 S *	2/2017	Strachan	D7/553.1
D605,896 S *	12/2009	Zalewski	D7/553.1	D778,155 S *	2/2017	Strachan	D7/555
D608,153 S	1/2010	Furlong		D778,722 S	2/2017	Strachan	
D615,822 S	5/2010	Klein		D784,769 S *	4/2017	Beckman	D7/553.1
D622,139 S	8/2010	Marcott et al.		D786,621 S *	5/2017	Davis	D7/553.1
D630,508 S	1/2011	Hubbard et al.		D792,160 S *	7/2017	Ng	D7/538
D630,885 S *	1/2011	Stein	D7/354	D792,161 S *	7/2017	Ng	D7/541
D631,741 S	2/2011	Hubbard et al.		D792,211 S *	7/2017	Foster	D9/425
D631,742 S	2/2011	Hubbard, Jr.		D792,222 S *	7/2017	Sill	D9/456
D631,743 S	2/2011	Hubbard, Jr.		D793,868 S *	8/2017	Kim	D9/756
D633,341 S	3/2011	Smyers		D798,707 S	10/2017	Mayer	
D643,311 S	8/2011	Meyers		2002/0108955 A1 *	8/2002	Erb	B65D 1/36 220/359.4
D645,708 S *	9/2011	Stamper	D7/602	2003/0217946 A1	11/2003	Hsu	
8,061,585 B2	11/2011	Nikolai		2004/0182916 A1	9/2004	Roseth	
D649,838 S	12/2011	Stamper					

2005/0051461	A1	3/2005	Bryant	
2005/0124521	A1 *	6/2005	Sadlowski D06F 35/006 510/295
2005/0150788	A1	7/2005	Feusner	
2007/0178194	A1	8/2007	Everard	
2008/0269034	A1	10/2008	Stier	
2009/0186132	A1 *	7/2009	Mangino B65D 1/36 426/120
2010/0065620	A1	3/2010	Smith	
2011/0240653	A1 *	10/2011	Castner A45C 11/20 220/526
2012/0234904	A1	6/2012	Costanzo, Jr.	
2014/0203070	A1	7/2014	Lee	
2014/0263353	A1	9/2014	Bell	
2014/0263600	A1	9/2014	Valencia	
2016/0107830	A1	4/2016	Baryshyan	

OTHER PUBLICATIONS

Innopak Innobox Edge Insert: Available 2017, Site Visited [Aug. 10, 2018]. Available from Internet URL: <http://www.innopak.com/product/food-service/take-out-packaging/innobox-edge-insert/>.*

Alibaba.com. Black Disposable Divided Food Trays. Oct. 17, 2013 [earliest on line date], [site visited Apr. 3, 2017]. Available from Internet, <URL: <https://thai.alibaba.com/product-detail/black-disposable-divided-food-trays-plastic-1238104653.html>>.

Flex Active Sports. Buy 3-Compartment Food Prep Containers. Jan. 5, 2016 [earliest online date], [site visited Apr. 17, 2017]. Available from Internet, <URL: <http://flexactivesports.com/buy-3-compartment-food-prep-containers/>>.

Webstaurant Store. Cambro 9113CW414 Camwear Teal 9" x11" 3 Compartment Meal Delivery Tray. Mar. 13, 201 O [earliest online date], [site visited Apr. 17, 2017]. Available from Internet, <URL: <http://www.webstaurantstore.com/cambro-9113cw414-camwear-teal-9-x-11-3-compartment-meal-delivery-tray-24-case/2149113CWTE.html>>.

Youtube. In no-Pak Rigid Microwavable Take Out Containers. Sep. 17, 2014 [earliest online date], [site visited Feb. 2, 2017]. Available from Internet, <URL: https://www.youtube.com/watch?time_continue=28&v=WolGFg_sHskY>.

Inno-Pak. Innobox Edge Insert. Oct. 25, 2016 [earliest on line date], [site visited Feb. 2, 2017]. Available from Internet, <URL: <http://www.innopak.com/product/food-service/take-out-packaging/inno-box-edge-insert/>>.

Southern Champion Tray 0761 #1. [online] Published date unknown. Retrieved on Jul. 13, 2017 from <URL: <https://www.importitall.co.za/Southern-Champion-Tray-0761-1-ChampPak-Retro-TakeOut-Container-Kraft-Paperboard-with-Poly-Coated-Inside-438-L--ap-BOODTNBD70.html>>.

Southern Champion Tray 0764 #4. [online] Published date unknown. Retrieved on Jul. 13, 2017 from <URL: <https://www.importitall.co.za/Southern-Champion-Tray-0764-4-ChampPak-Retro-TakeOut-Container-Kraft-Paperboard-with-Poly-Coated-Inside-734-L--ap-BOODE035YG.html>>.

Curved lid box, available Nov. 2, 2013, [online], [site visited Oct. 30, 2015]. Available from internet, <URL: <http://www.robves.com/category/tags/highlight?page=3>>.

Empty candy boxes, available 10/12/2013, [on line], [site visited Oct. 30, 2015]. Available from internet, <URL: <http://www.blaircandy.com/emcabo.html>>.

Inno-Pak is Staying Put, available Jun. 13, 2015, [on line], [site visited 12/11/2015]. Available from internet, <URL: <http://delgazette.com/news/295/inno-pak-is-staying-put>>.

Kalifornia Love. Jul. 28, 2010 [earliest on line date], [site visited Nov. 4, 2016]. Available from Internet, <URL: <http://www.kalifornialove.com/2010/07/extra-fruit-sensations-sweet-watermelon.html>>.

Natural Krall Windowed Boxes, available Oct. 4, 2014, [online], [site visited 12/11/2015]. Available from internet, <URL: <http://www.splashpackaging.com/Natural-Kraft-Window-Bakery-Boxes>>.

NEAROF! Review: Stride Spark Vitamin Chewing Gum. Sep. 7, 2011 [earliest on line date], [site visited Nov. 4, 2016]. Available from Internet, <URL: <http://www.nearof.com/?p=540>>.

Origami treasure chest {YouTube}, available Nov. 29, 2010, [on line], [site visited Oct. 30, 2015]. Video available from internet, <URL: <https://www.youtube.com/watch?v=WpgGqeBQvj4>>.

Southern Champion Tray Window Bakery Box, available Mar. 15, 2013, [online], [site visited 12/11/2015]. Available from internet, <URL: http://www.amazon.com/gp/product/B008WCWJ9S/ref=s9_zwish_hd_bw_g328_i1?pf_rd_m=ATVPDKIKXODER&pf_rd_s=merchandise-search-5&pf_rd_r=OF299N2PNPMAY8WZM12D&pf_rd_1=101&pf_rd_p=2223275202&pf_rd_i=5016466011>.

Take-out Container, available Jan. 17, 2013, [on line], [site visited Oct. 30, 2015]. Available from internet, <URL: http://www.amazon.com/Southern-Champion-Tray-0731-Paperboard/productreviews/B004NG9A2Q/ref=cm_er_pr_btm_link_2?ie=UTF8&showViewpoints=1&sortBy=bySubmissionDateDescending&reviewerType=all_reviews&fomnatType=all_formals&pageNumber=2>.

Amazon. Food Containers 3 Compartment Premium. Jul. 18, 2017 [earliest online date], [site visited Mar. 8, 2018]. Available from Internet, <URL: https://www.amazon.com/dp/80741BQMY7/ref=sspa_dk_detail_2?psc=1&pd_rd_i=B0741BQMY7&pd_rd_wg=gDStp&pd_rd_r=ACEV1YJAC97ZZPCCXWCW&pd_rd_w=XZKtg>. (Year: 2017).

Dean Supply. Disposable Takeout Containers. 2018 [earliest online date], [site visited Mar. 8, 2018]. Available from Internet, <URL: <https://www.shopatdean.com/collections/disposable-takeout-containers-foam-paper-plastic-compostable/rectangular>>. (Year: 2018).

Placon. Fresh n Clear GoCubes Black Insert Tray. 2016 [earliest online date], [site visited Jul. 3, 2008]. Available from Internet, <URL: <https://www.placon.com/products/stock-food-package/fresh-n-clear-gocubes-black-insert-tray/>>. (Year: 2016).

* cited by examiner

Primary Examiner — Jennifer Rivard
 Assistant Examiner — Catherine S Posthauer
 (74) Attorney, Agent, or Firm — Ward and Smith, P.A.;
 Ryan K. Simmons

(57) CLAIM

The ornamental design for a compartmented carton insert, as shown and described.

DESCRIPTION

FIG. 1 is a perspective view of a first embodiment of the compartmented carton insert showing our new design;
 FIG. 2 is a front view thereof;
 FIG. 3 is a rear view thereof;
 FIG. 4 is a left side view thereof;
 FIG. 5 is a right side view thereof;
 FIG. 6 is a top plan view thereof;
 FIG. 7 is a bottom plan view thereof;
 FIG. 8 is another perspective view thereof showing the compartmented carton insert inserted in a carton;
 FIG. 9 is a perspective view of a second embodiment of the compartmented carton insert;
 FIG. 10 is a front view thereof;
 FIG. 11 is a rear view thereof;
 FIG. 12 is a left side view thereof;
 FIG. 13 is a right side view thereof;
 FIG. 14 is a top plan view thereof;
 FIG. 15 is a bottom plan view thereof;
 FIG. 16 is another perspective view thereof showing the compartmented carton insert inserted in a carton;
 FIG. 17 is a perspective view of a third embodiment of the compartmented carton insert;
 FIG. 18 is a front view thereof;
 FIG. 19 is a rear view thereof;

FIG. 20 is a left side view thereof;
FIG. 21 is a right side view thereof;
FIG. 22 is a top plan view thereof;
FIG. 23 is a bottom plan view thereof;
FIG. 24 is another perspective view thereof showing the compartmented carton insert inserted in a carton;
FIG. 25 is a perspective view of a fourth embodiment of the compartmented carton insert;
FIG. 26 is a front view thereof;
FIG. 27 is a rear view thereof;
FIG. 28 is a left side view thereof;
FIG. 29 is a right side view thereof;
FIG. 30 is a top plan view thereof;
FIG. 31 is a bottom plan view thereof; and,
FIG. 32 is another perspective view thereof showing the compartmented carton insert inserted in a carton.
The broken lines are shown for the purpose of illustrating environmental subject matter of a carton and form no part of the claimed design.

1 Claim, 24 Drawing Sheets

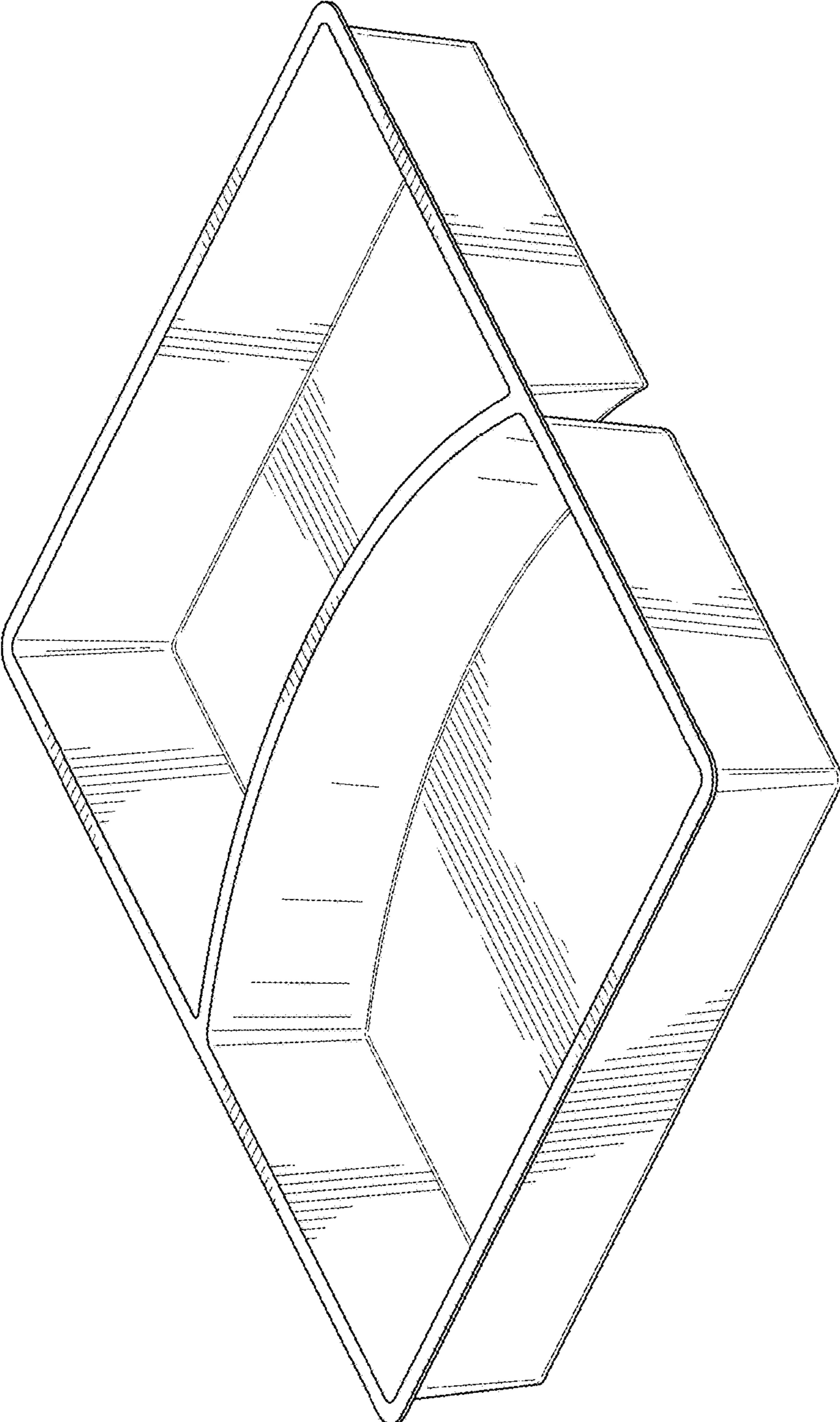

FIG. 1

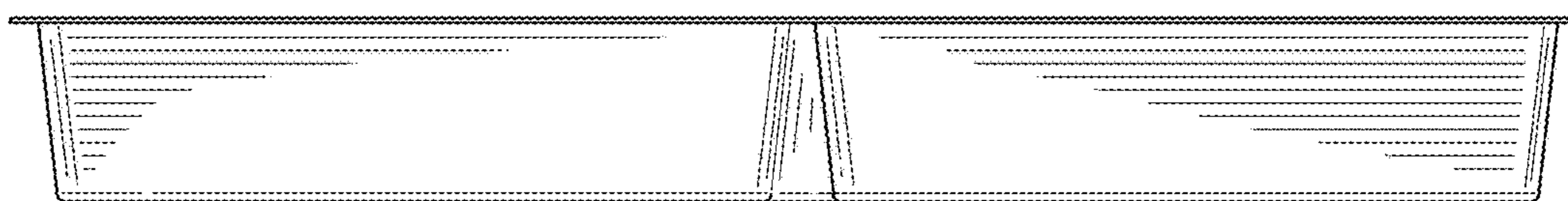

FIG. 2

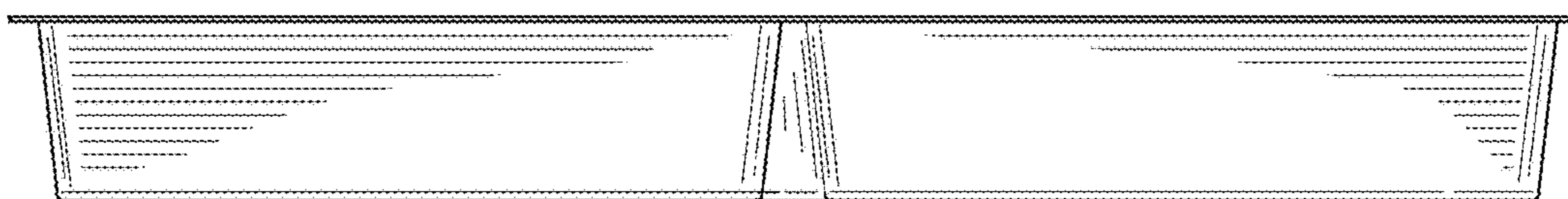

FIG. 3

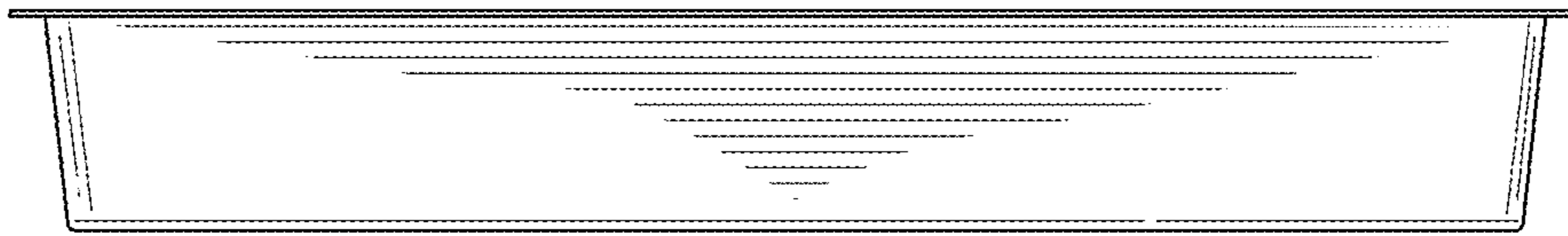

FIG. 4

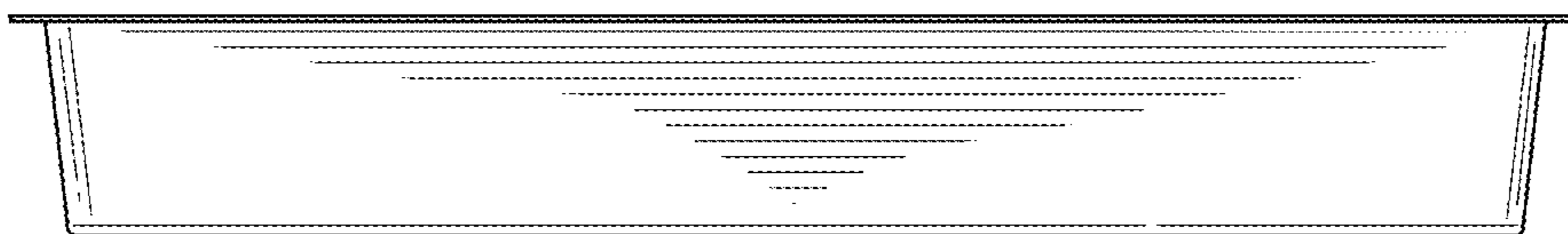

FIG. 5

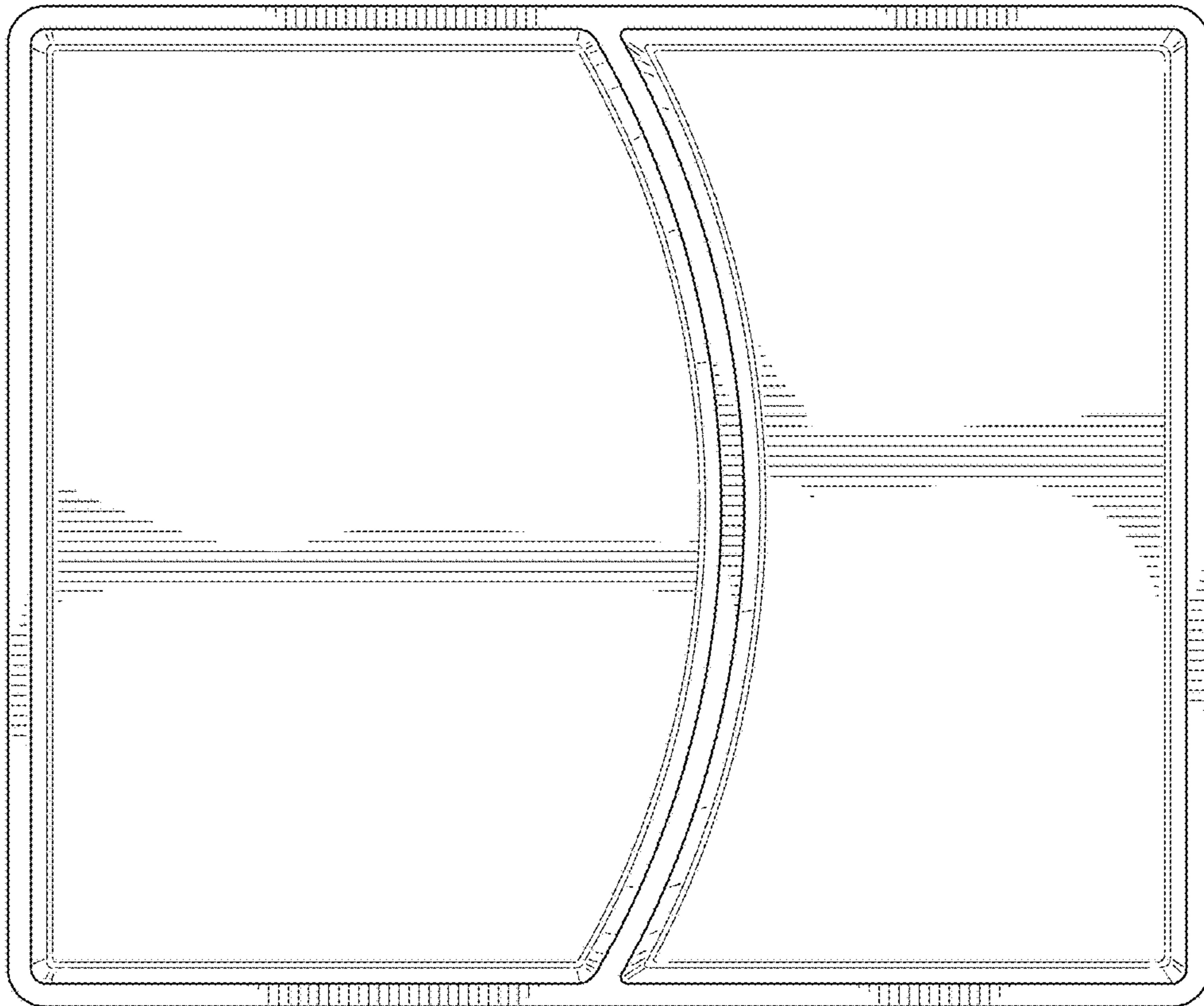

FIG. 6

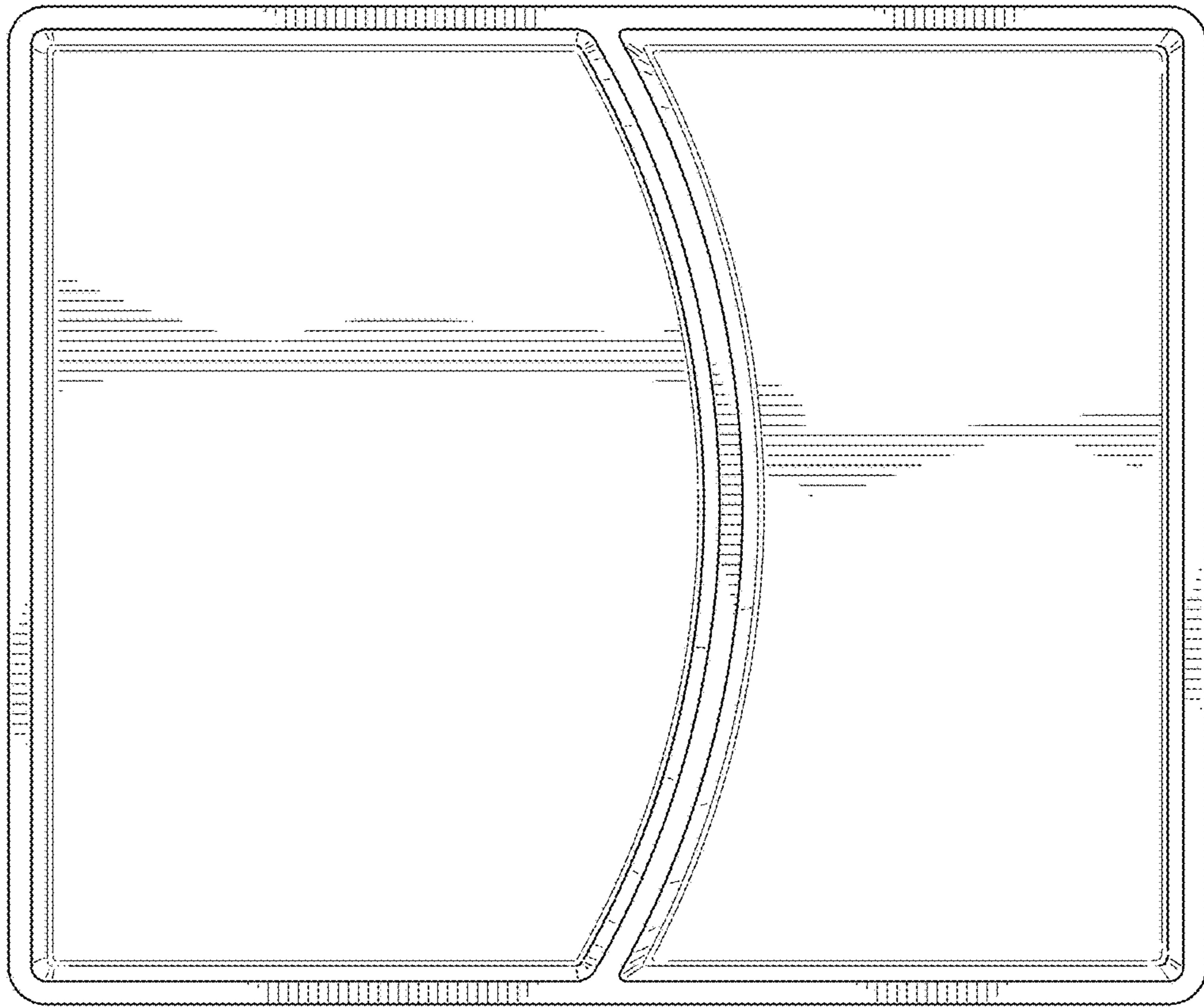

FIG. 7

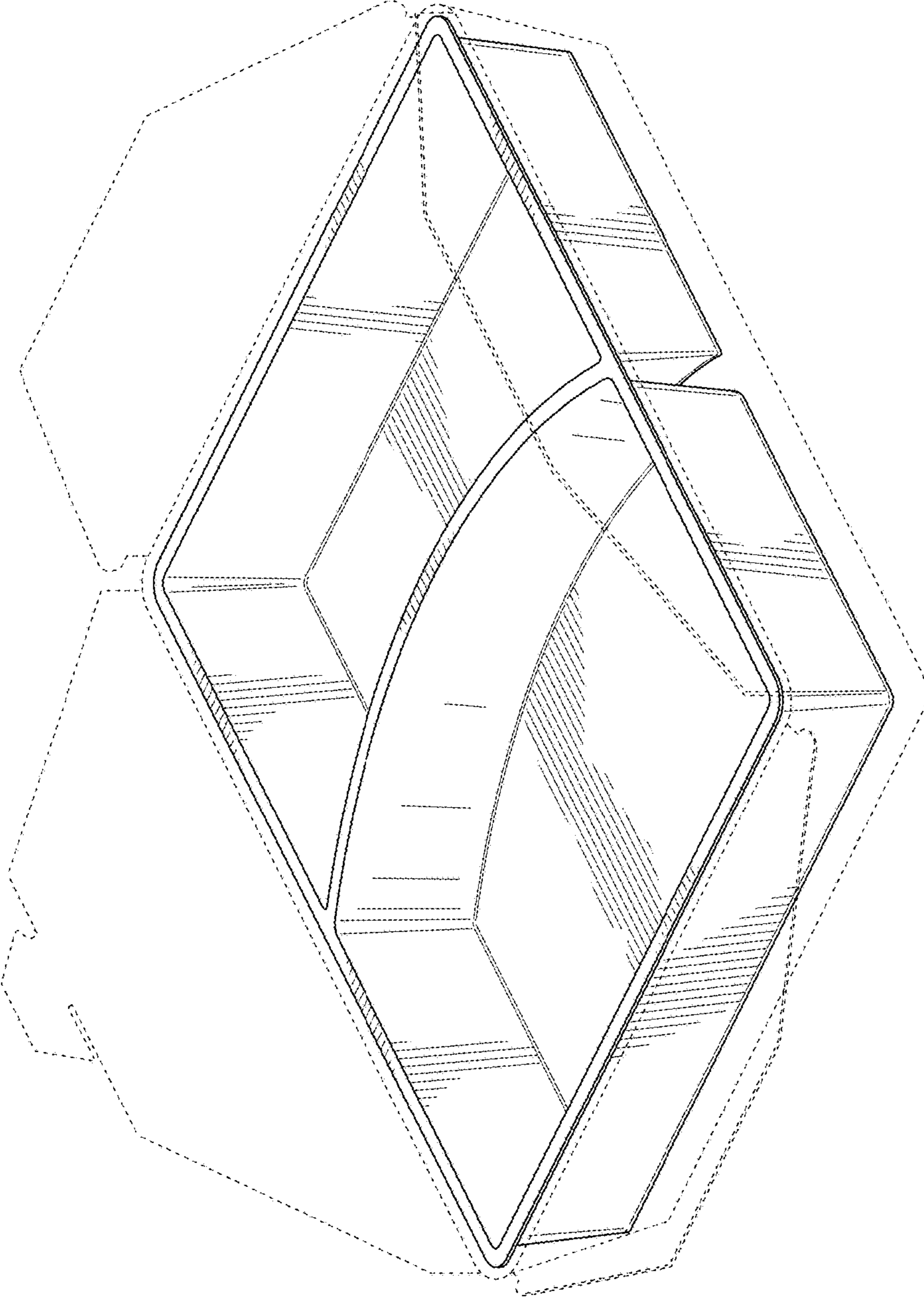

FIG. 8

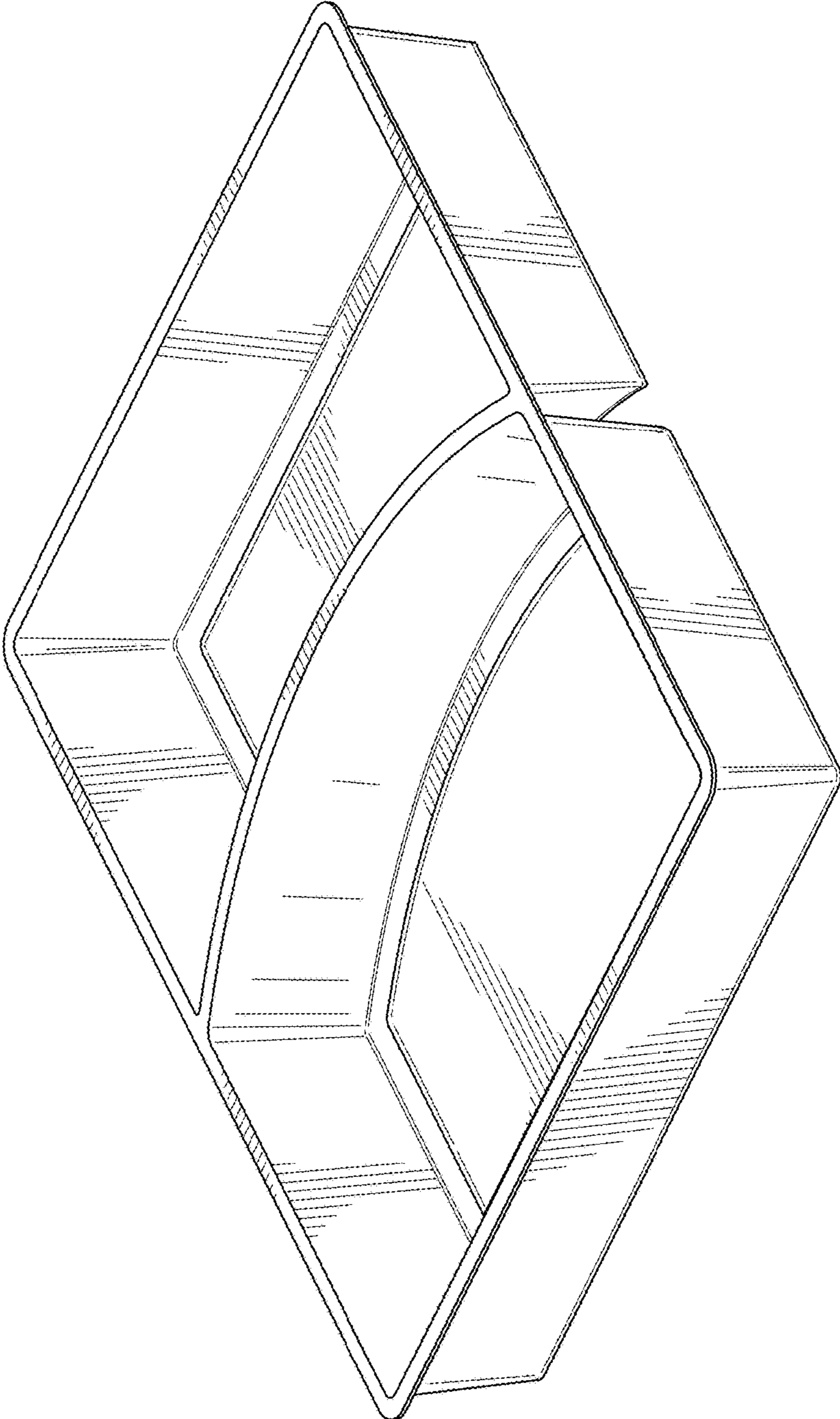

FIG. 9

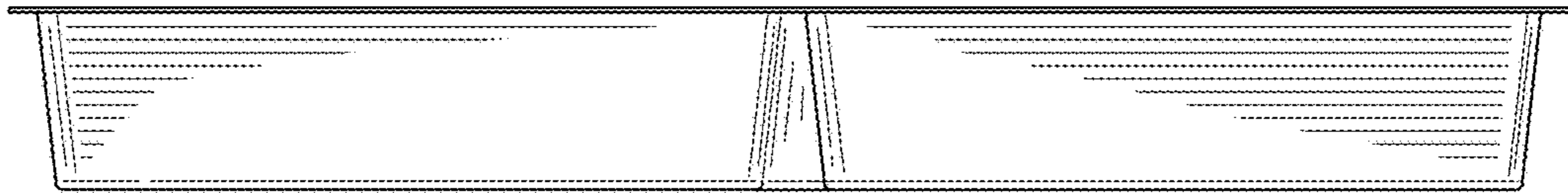

FIG. 10

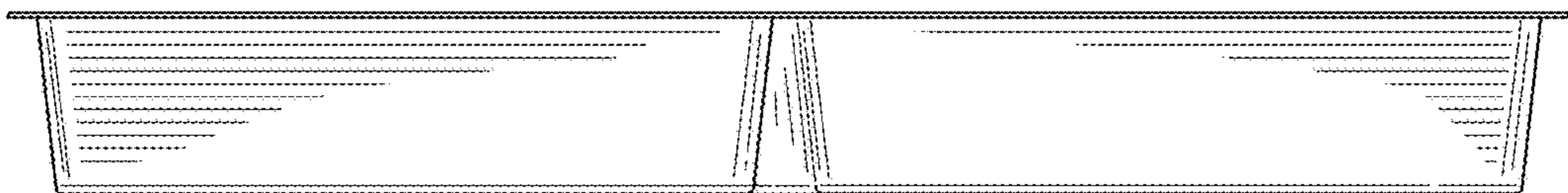

FIG. 11

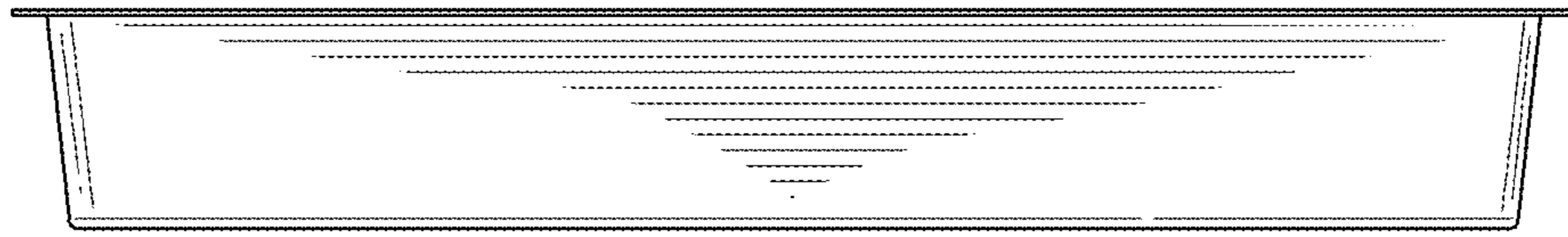

FIG. 12

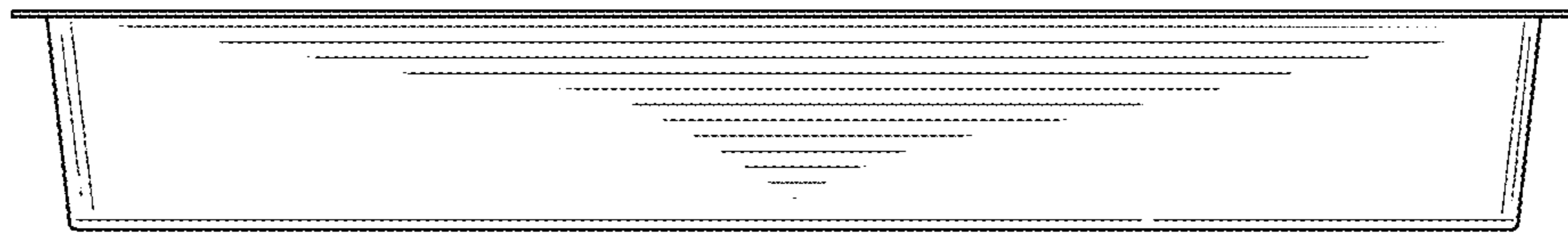

FIG. 13

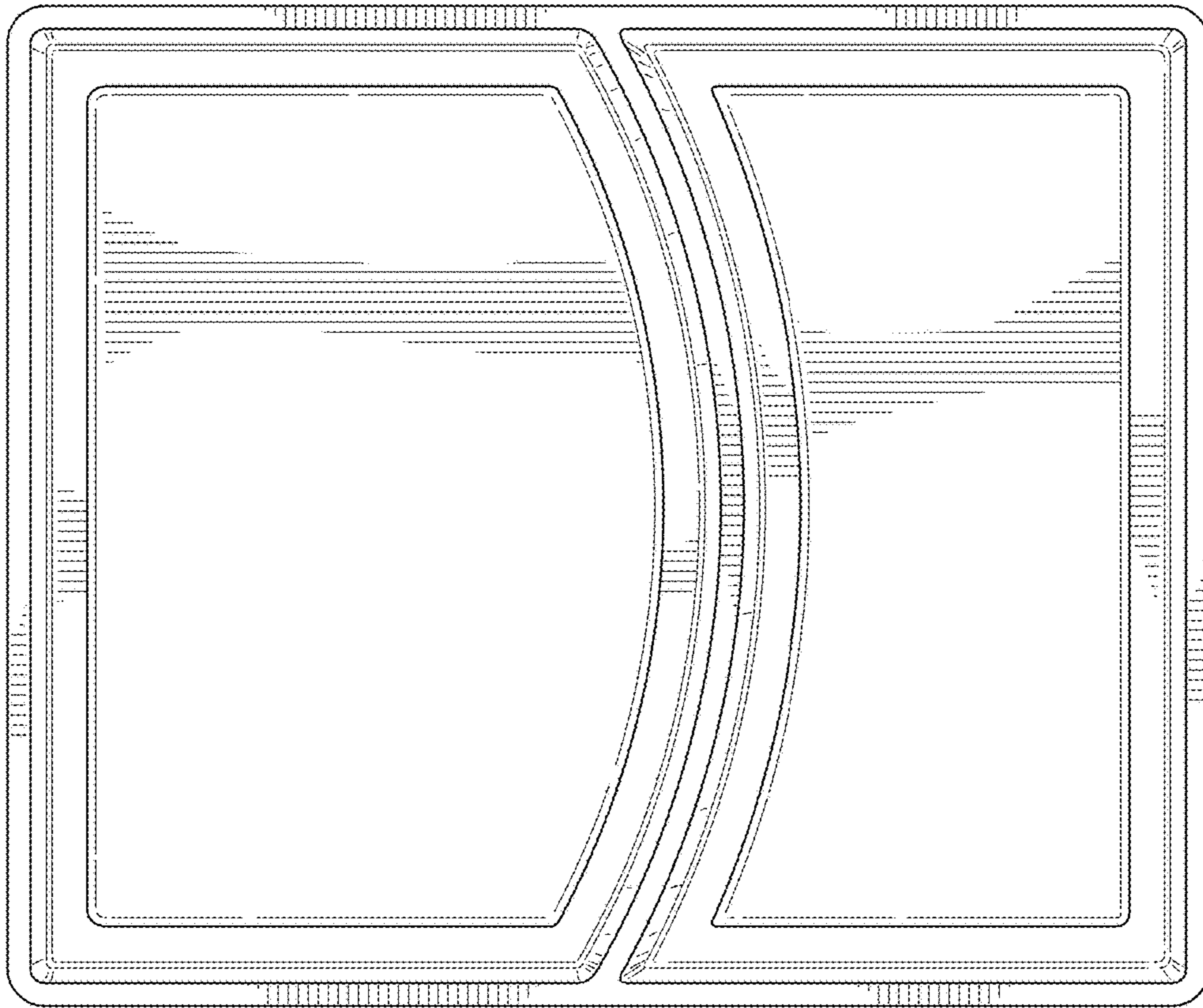

FIG. 14

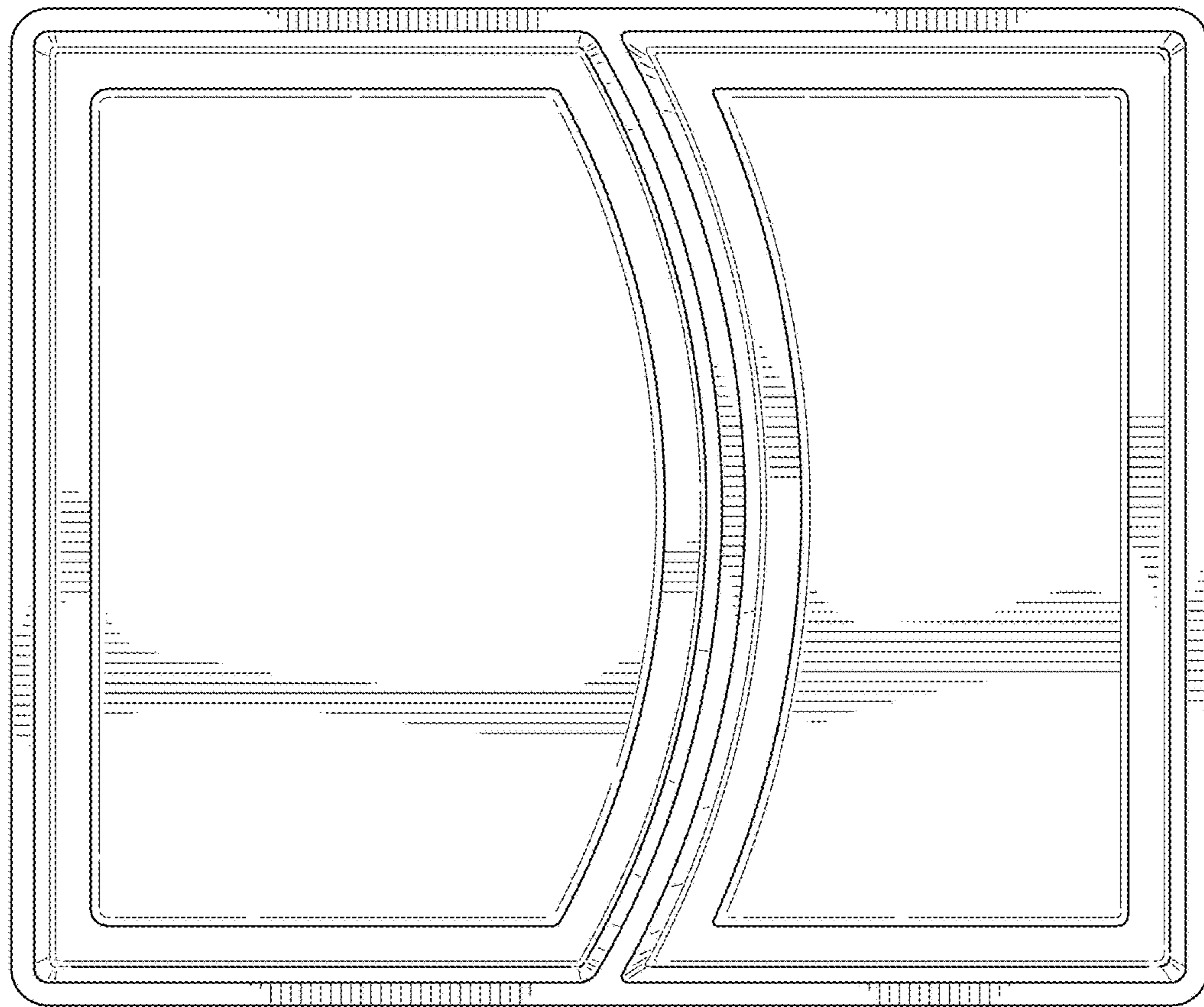

FIG. 15

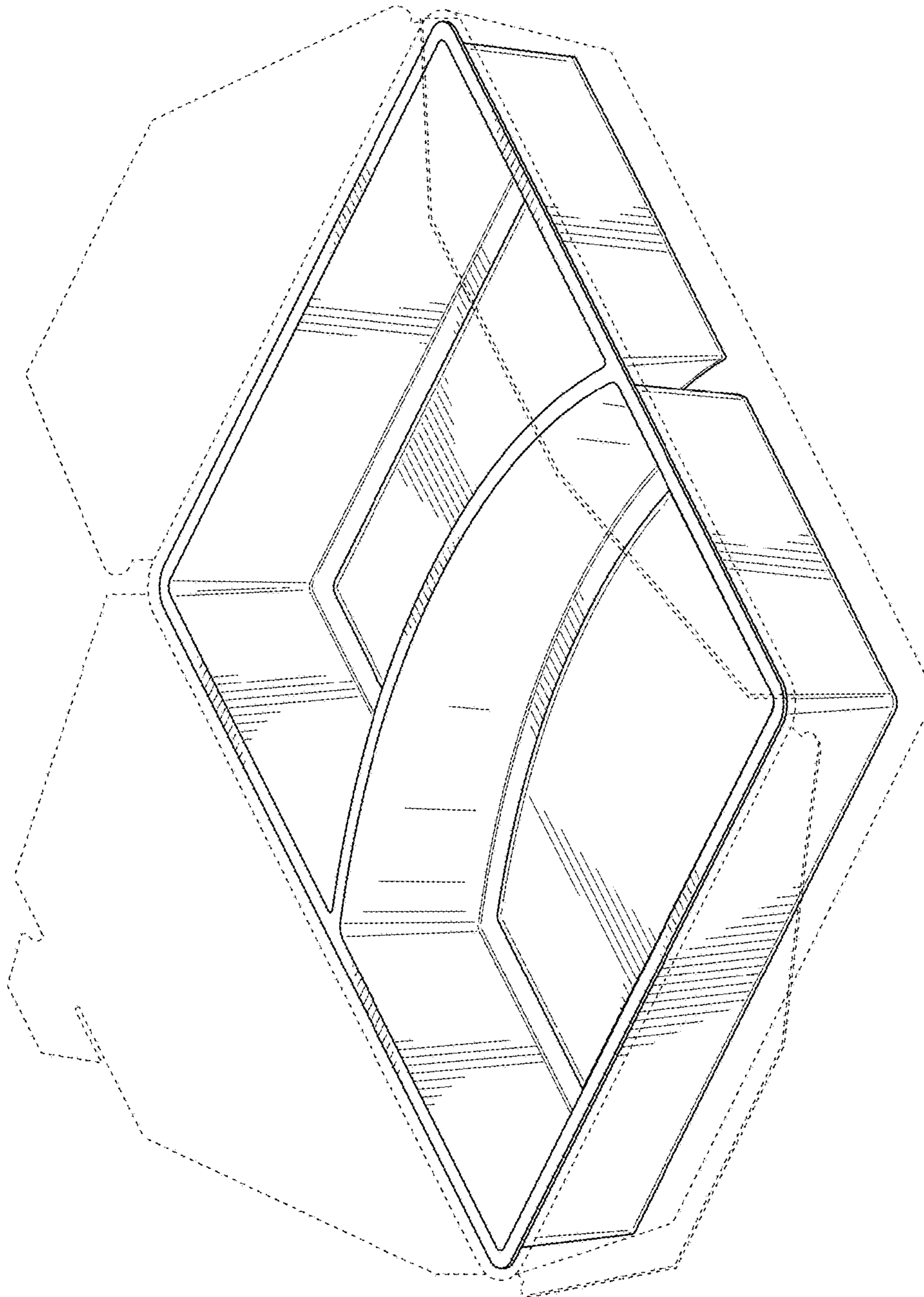

FIG. 16

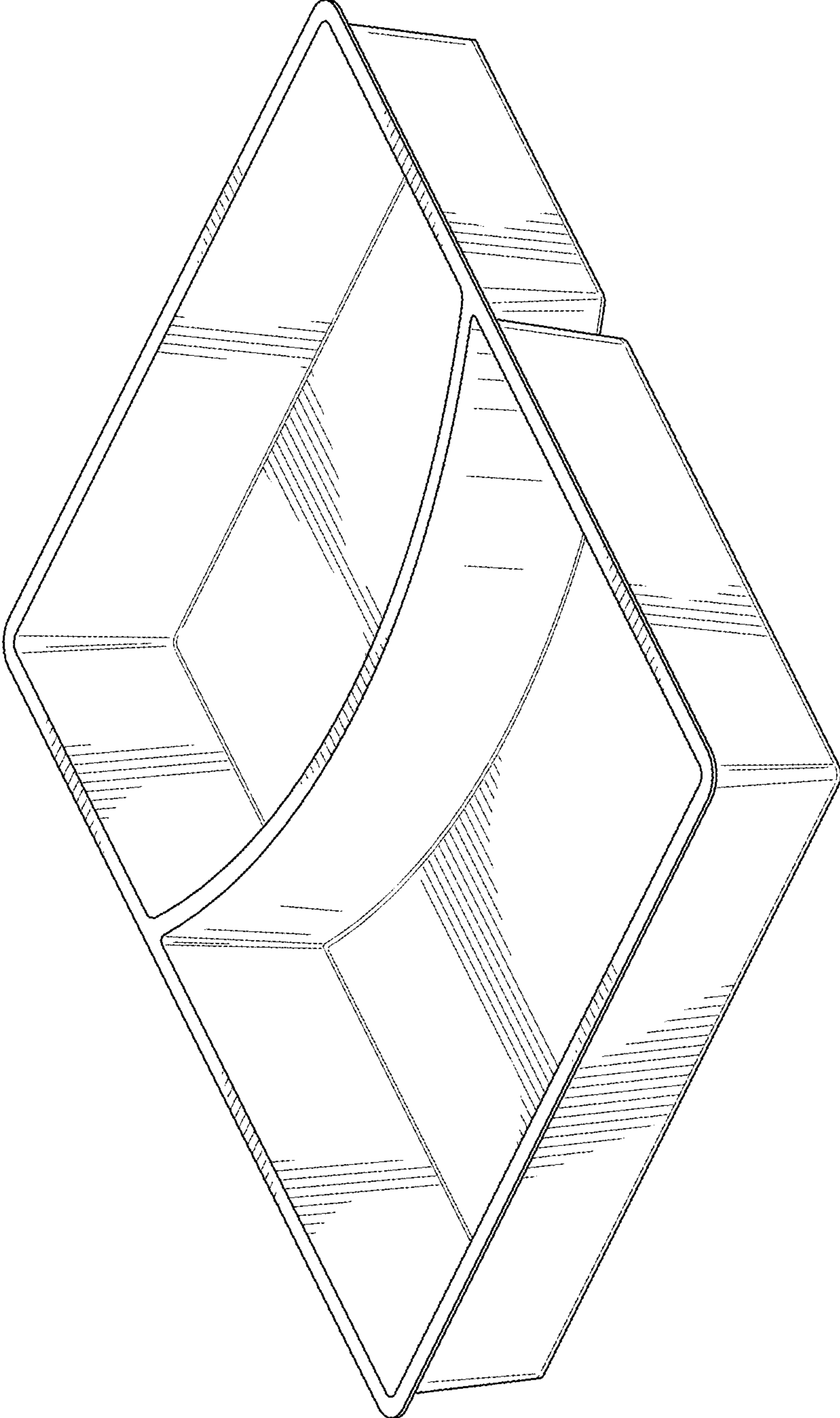

FIG. 17

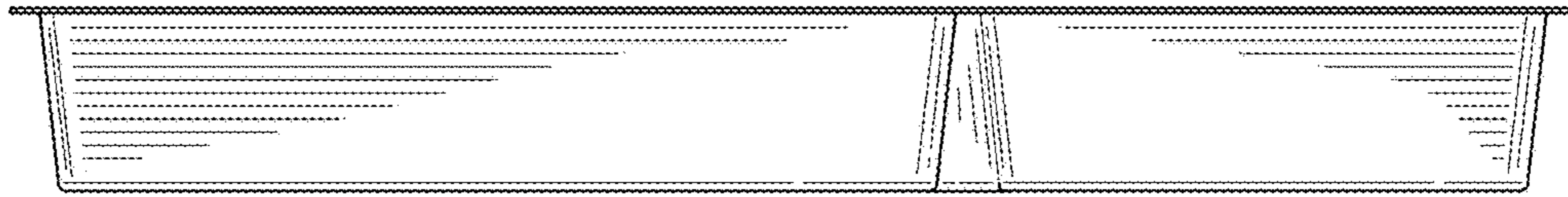

FIG. 18

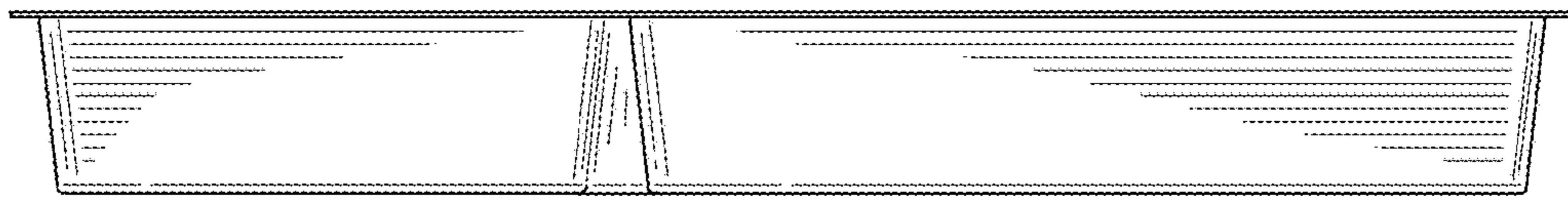

FIG. 19



FIG. 20

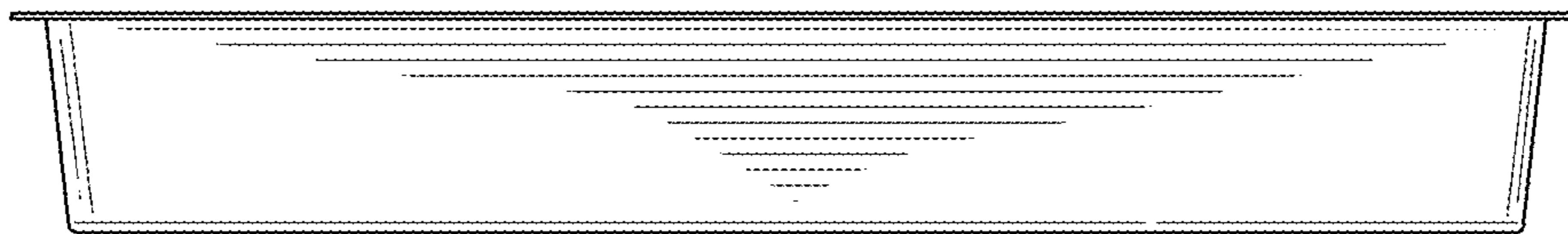

FIG. 21

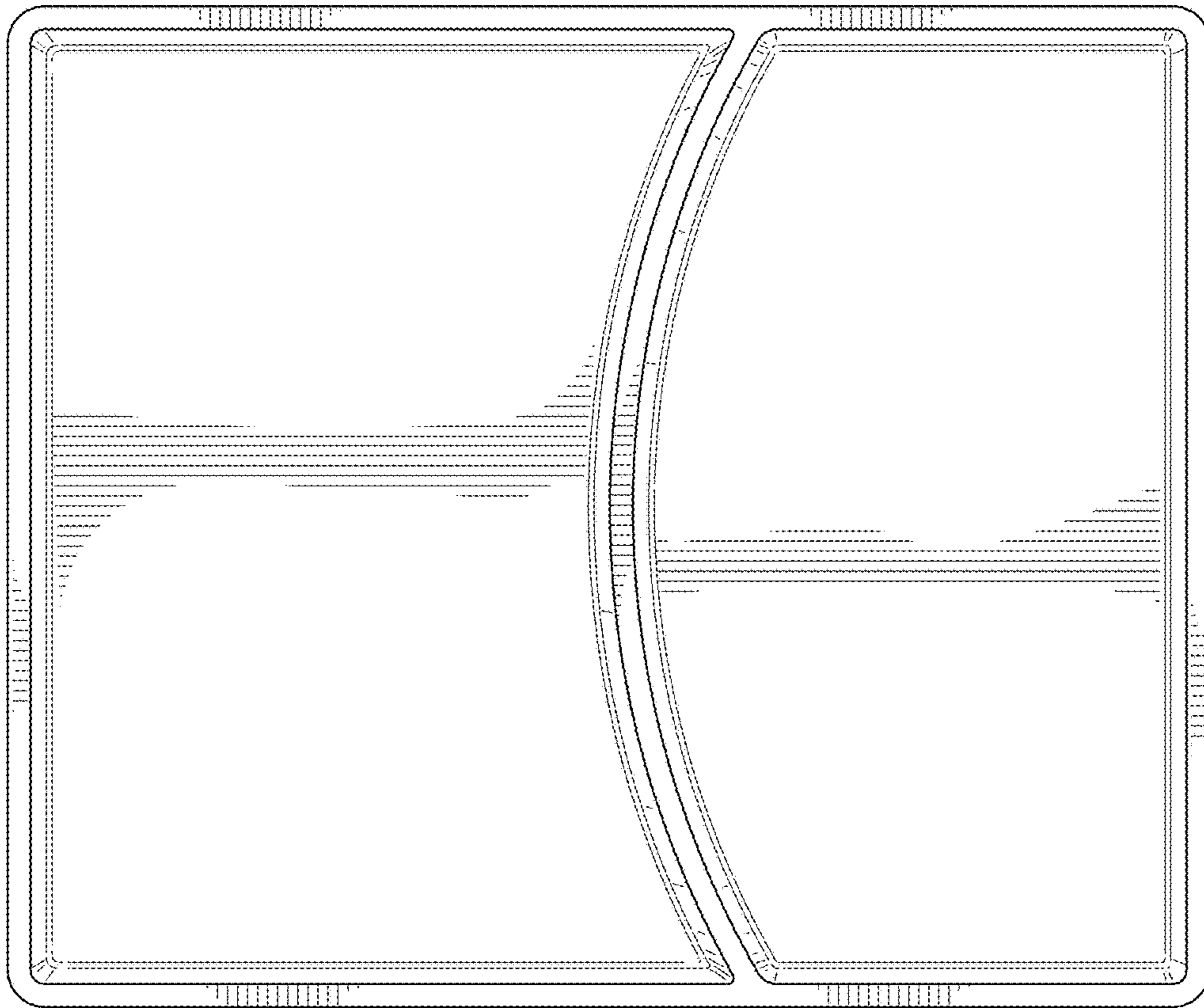

FIG. 22

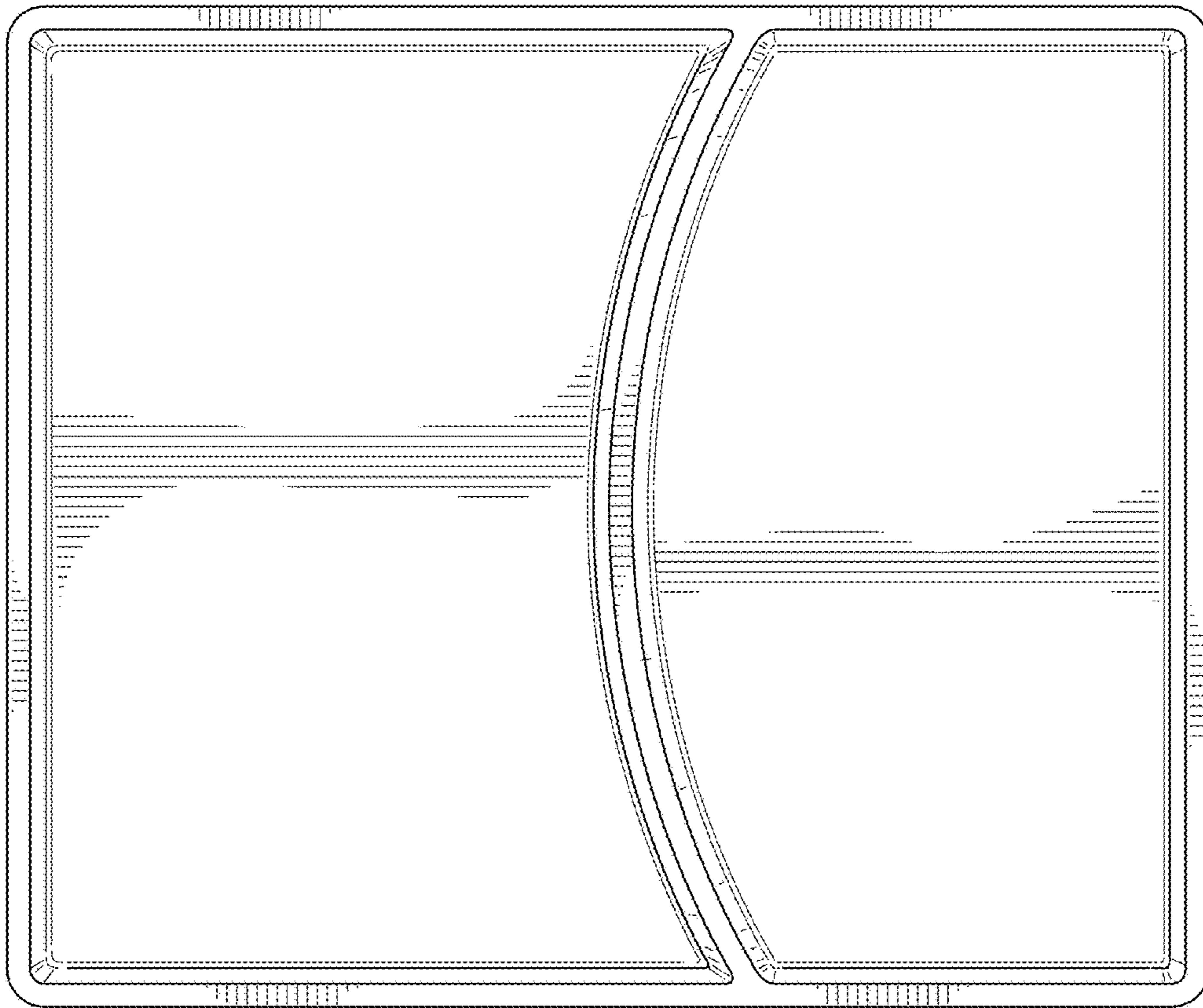

FIG. 23

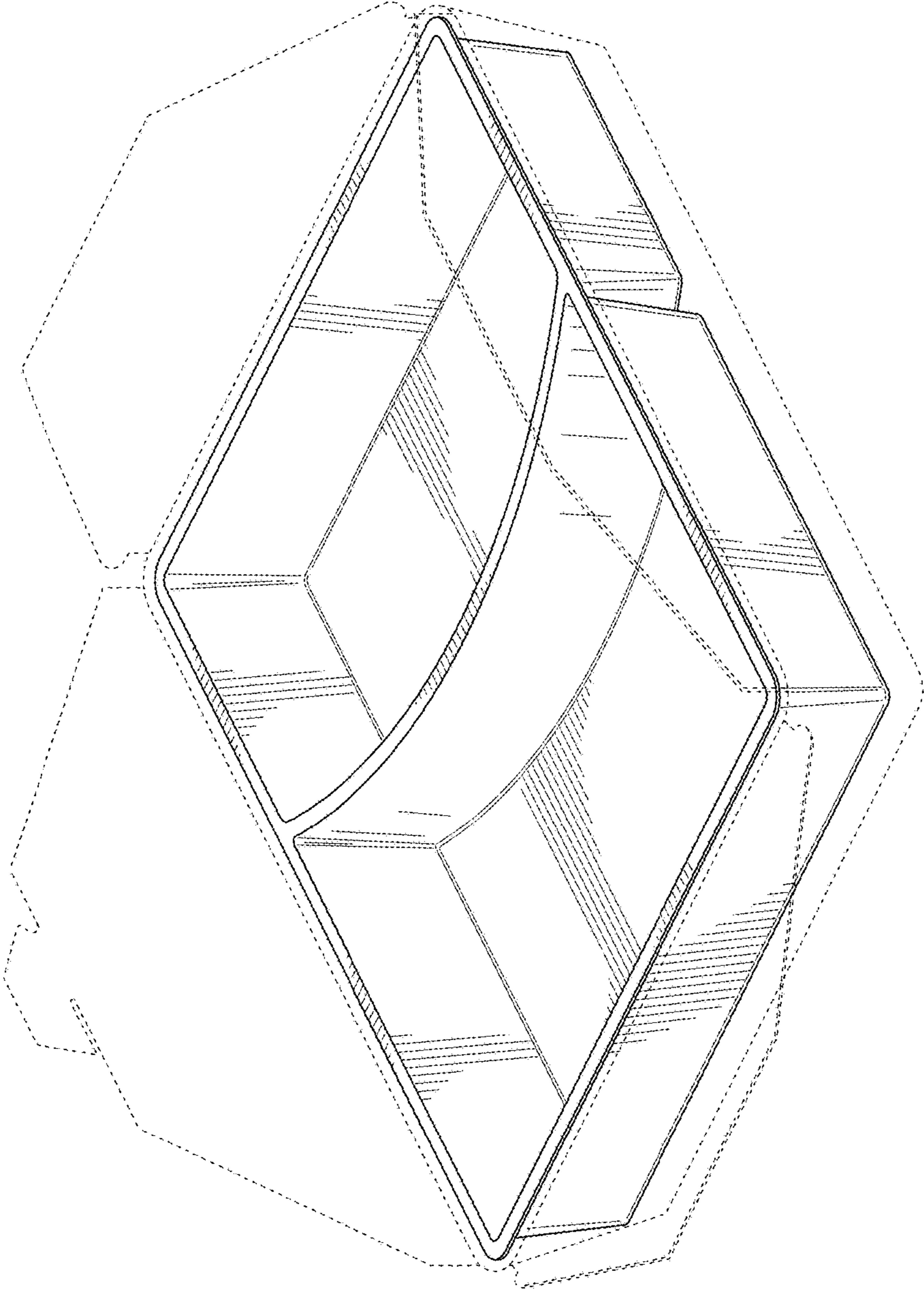

FIG. 24

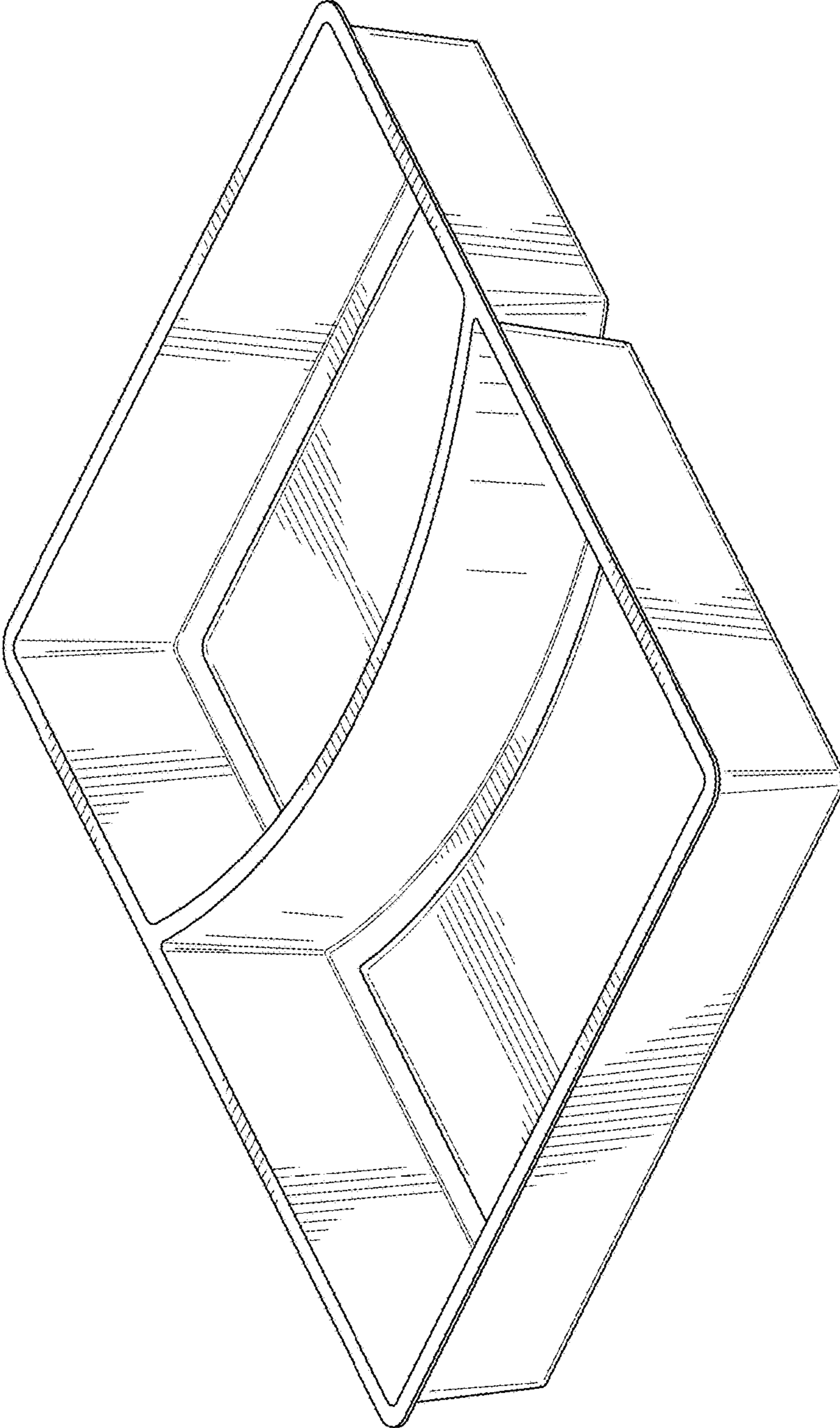

FIG. 25

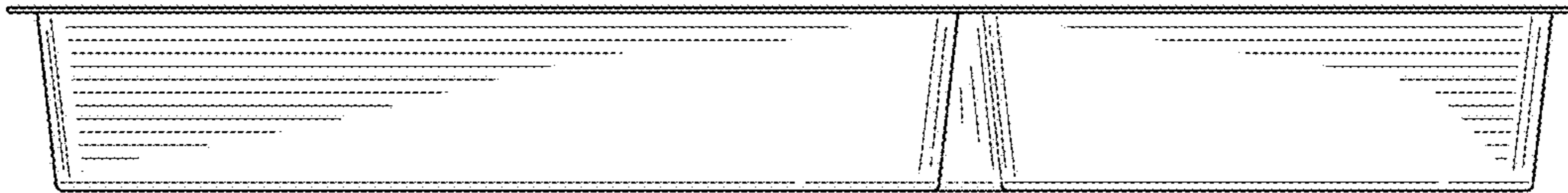

FIG. 26

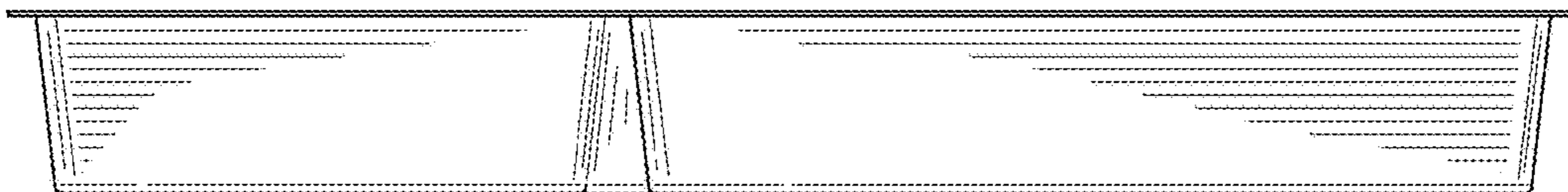

FIG. 27

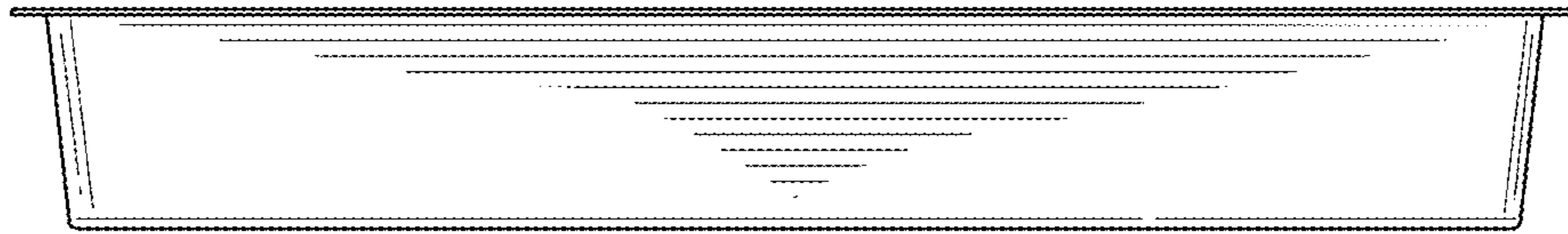

FIG. 28

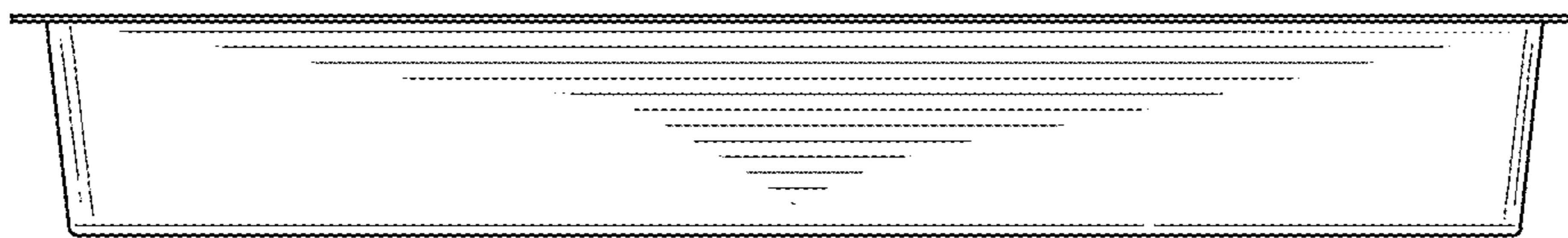

FIG. 29

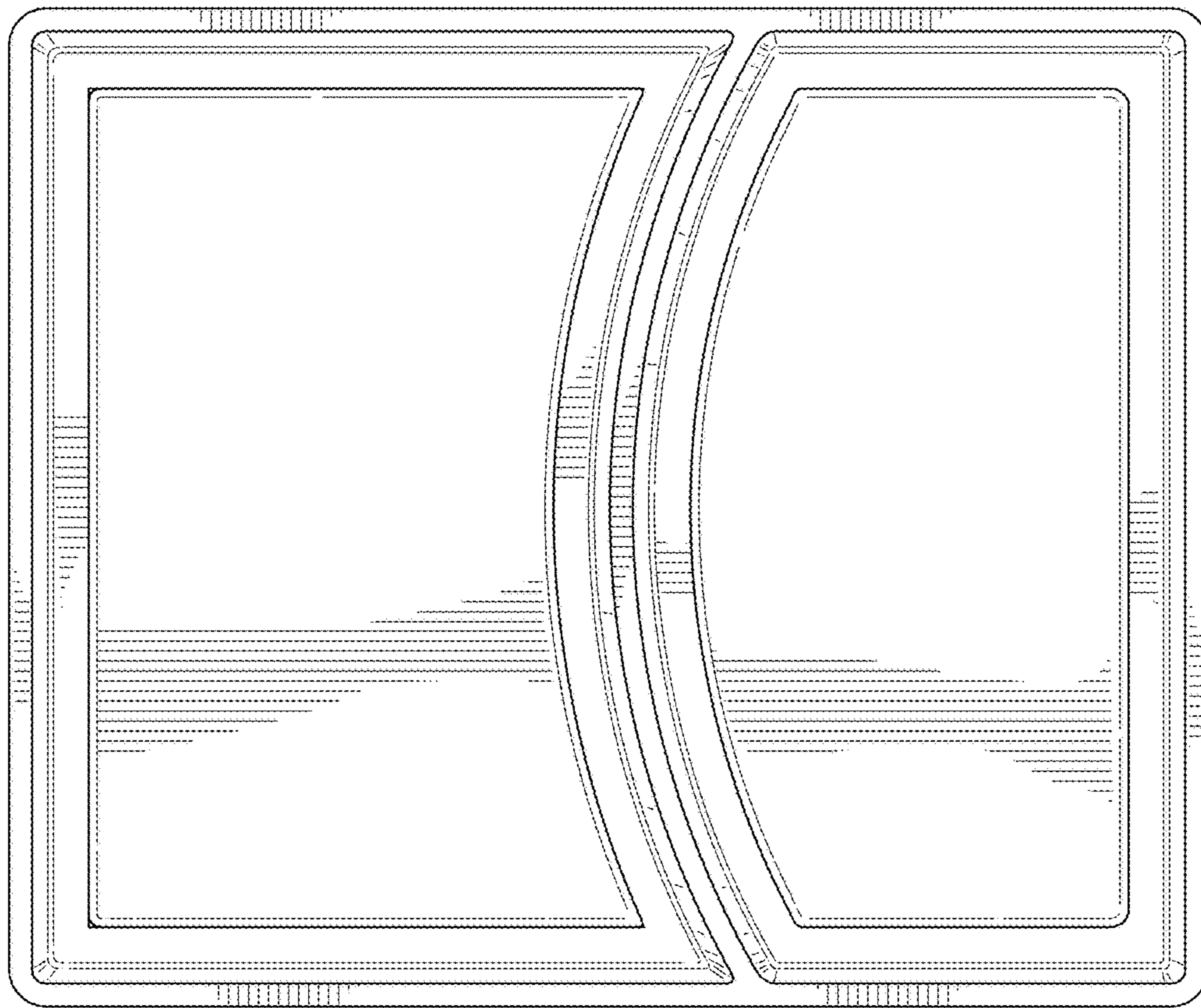

FIG. 30

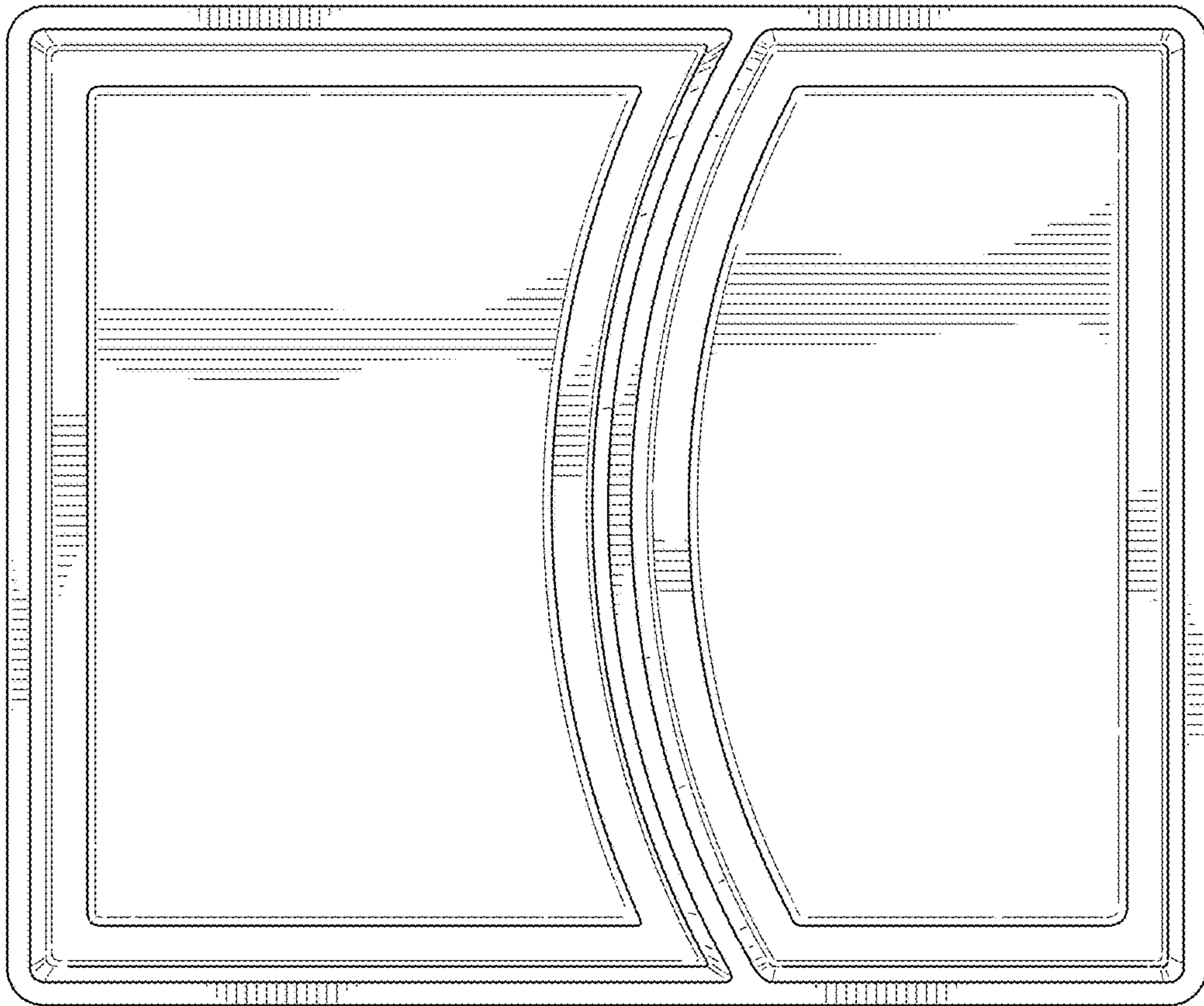

FIG. 31

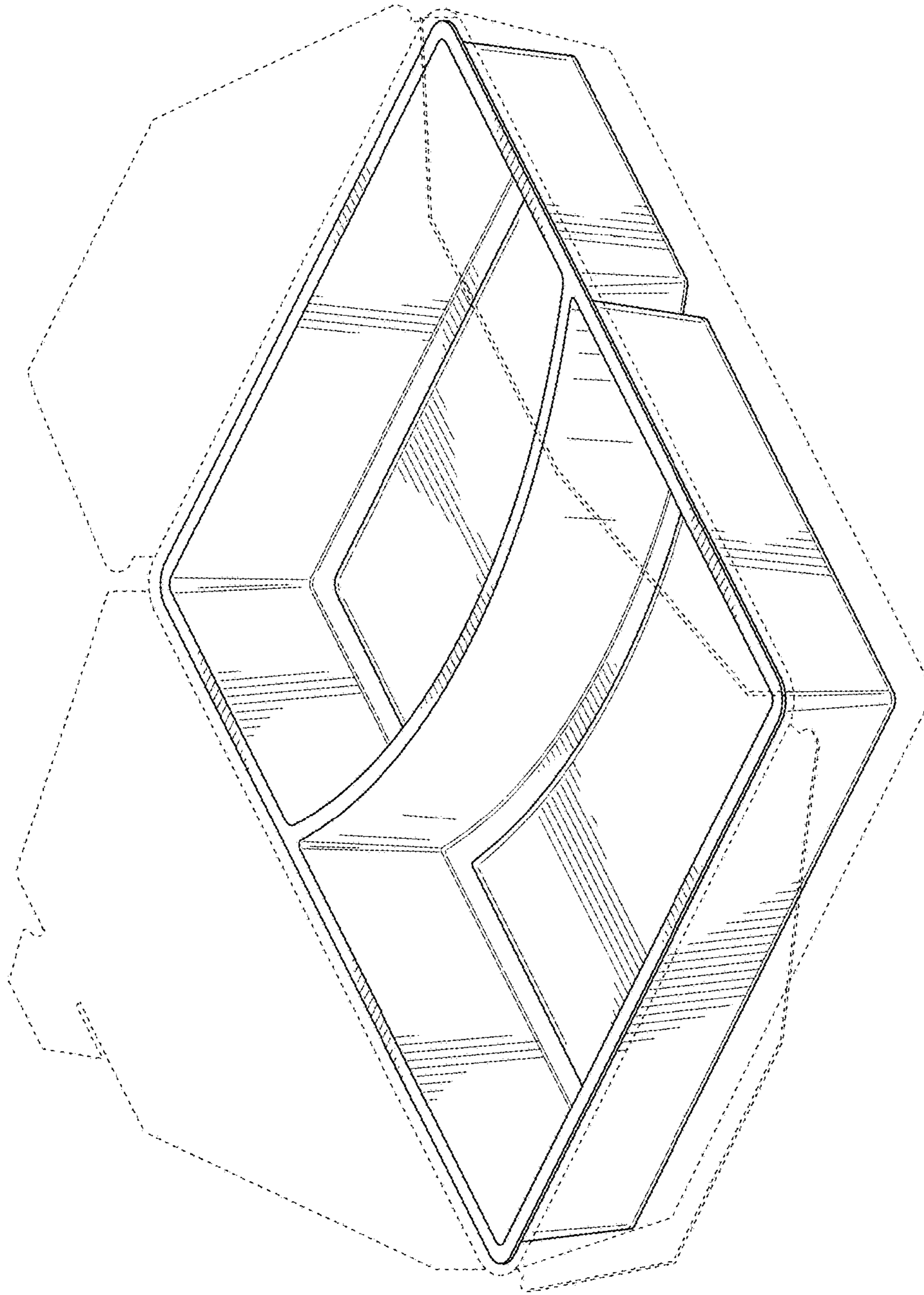

FIG. 32