



US00D840187S

(12) **United States Design Patent** (10) **Patent No.:** **US D840,187 S**
Sams et al. (45) **Date of Patent:** **** Feb. 12, 2019**

(54) **BOTTLE COVERING**

(71) Applicant: **SIGG Switzerland Bottles AG**,
Frauenfeld (CH)

(72) Inventors: **Stephen Sams**, Hertfordshire (GB);
James Phillip Salisbury,
Cambridgeshire (GB)

(73) Assignee: **SIGG SWITZERLAND BOTTLES**
AG, Frauenfeld (CH)

(**) Term: **15 Years**

(21) Appl. No.: **29/584,274**

(22) Filed: **Nov. 14, 2016**

(30) **Foreign Application Priority Data**

Jun. 26, 2016 (WO) DM/093101

(51) **LOC (11) Cl.** **07-99**

(52) **U.S. Cl.**
USPC **D7/392**

(58) **Field of Classification Search**
USPC D9/452, 453, 454, 435, 447, 449, 780,
D9/434, 424, 430, 443; D7/391, 392,
D7/392.1, 510, 511, 538, 540, 542, 543,
D7/544, 545, 629, 354, 360, 396.1, 602,
D7/705
CPC ... A47G 19/2205; A47G 19/2222; A45F 3/16;
A45F 3/20; B67D 7/06; B67D 1/0004;
B65D 25/14; B65D 47/065; B65D
47/066; B65D 2543/00101; B65D
2543/00027

See application file for complete search history.

(56) **References Cited**

U.S. PATENT DOCUMENTS

D608,195 S * 1/2010 Germann D9/443
D627,602 S * 11/2010 Eyal D7/510
D652,255 S * 1/2012 Carland D7/510
D736,038 S * 8/2015 Kilduff D7/615

D767,337 S * 9/2016 Boroski D7/510
D801,173 S * 10/2017 Lown D9/449
D801,174 S * 10/2017 Lown D9/449
D804,304 S * 12/2017 Pearson D9/443
D808,213 S * 1/2018 Lown D7/396.2
D816,400 S * 5/2018 Beckman D7/396.2

OTHER PUBLICATIONS

SIGG website, Miracle Blue 0.6 L, Publication date unknown, [site visited May 3, 2018], Available on the Internet URL <https://en.sigg.ch/miracle-blue-bottle>.*

Sport Bittle website, Sigg Miracle Alu Love 0,6l Drinking Bottle Kids, Publication date unknown, [site visited May 3, 2018], Available on the Internet URL https://www.sport-bittl.com/en/sigg-miracle-alu-love-06l-drinking-bottle-kids::107872_1_412.html.*

Trinkflaschen Ratgeber website, SIGG Miracle Trinkflasche Testbericht, Publication date unknown, [site visited May 3, 2018], Available on the Internet URL <https://trinkflaschen-ratgeber.de/testbericht/sigg-miracle-trinkflasche/>.*

* cited by examiner

Primary Examiner — Karen S Acker

Assistant Examiner — Steven B Reinholdt, Jr.

(74) *Attorney, Agent, or Firm* — Pearne & Gordon LLP

(57) **CLAIM**

The ornamental design for a bottle covering, as shown and described.

DESCRIPTION

FIG. 1 is a first perspective view of our new invention;

FIG. 2 is a second perspective view thereof;

FIG. 3 is a top view thereof;

FIG. 4 is a front view thereof;

FIG. 5 is a left view thereof;

FIG. 6 is a right view thereof;

FIG. 7 is a bottom view thereof; and,

FIG. 8 is a rear view thereof.

The broken lines in the drawings depict portions of the bottle covering that form no part of the claimed design.

1 Claim, 8 Drawing Sheets

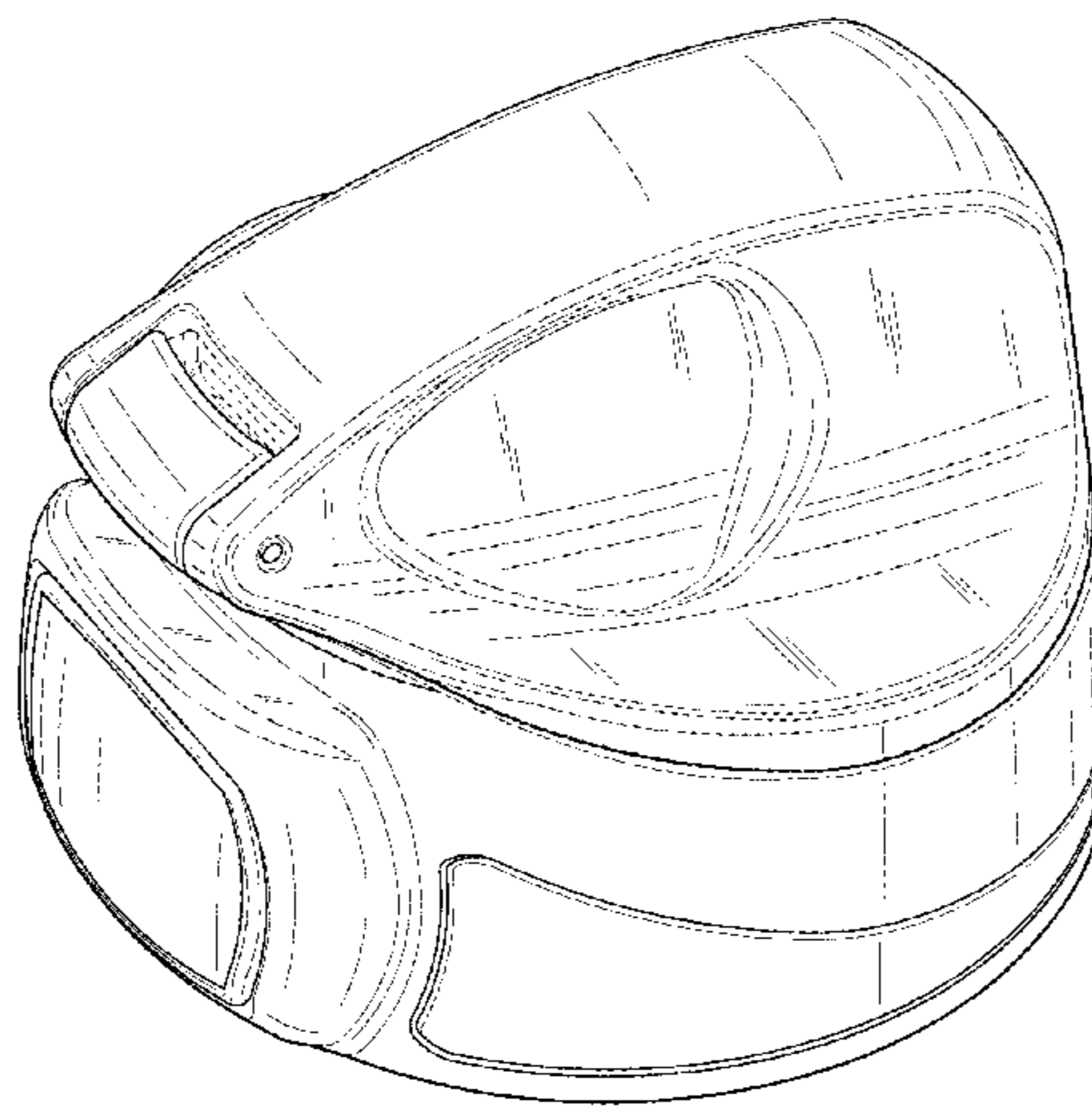

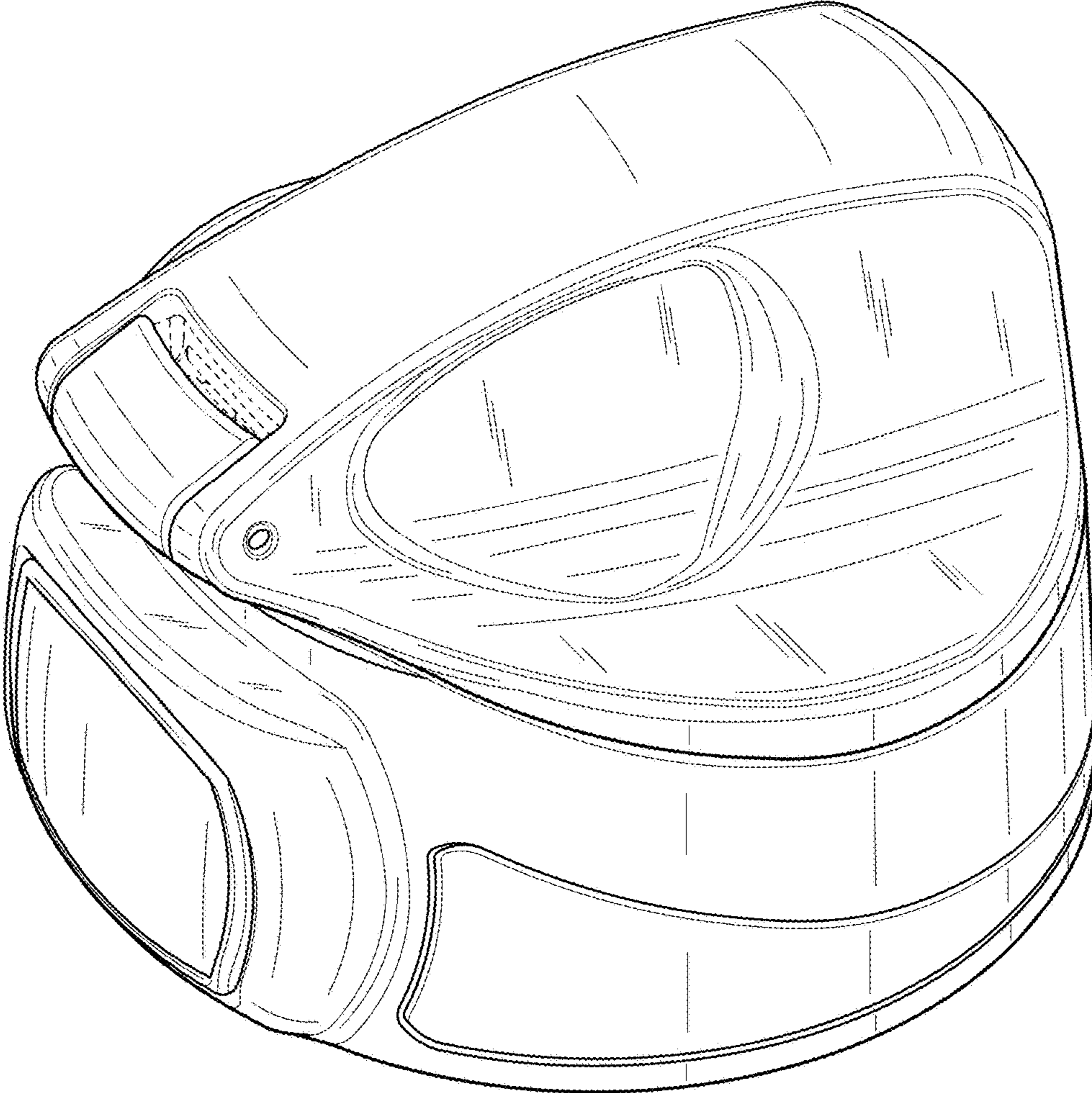

FIG. 1

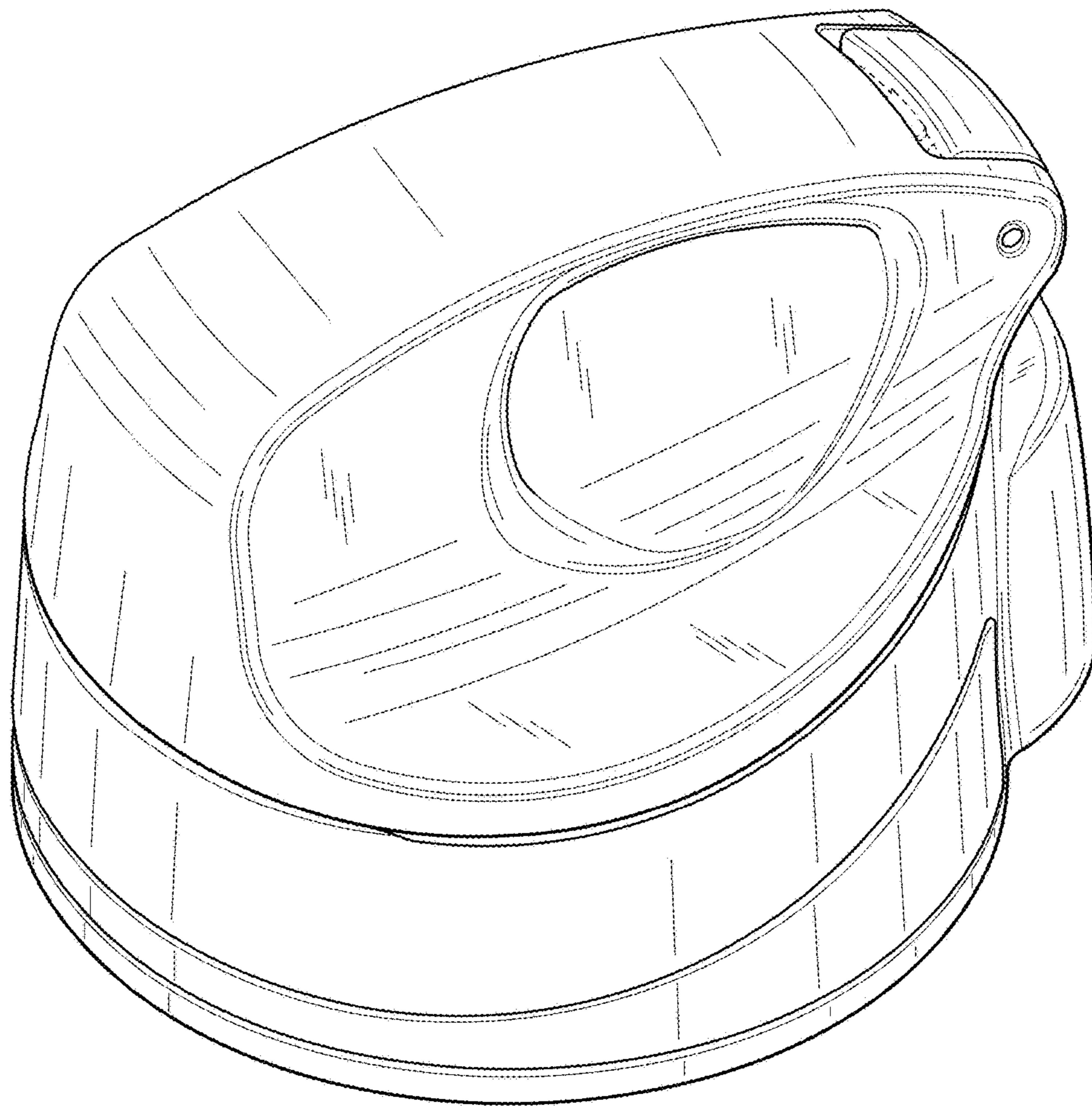

FIG. 2

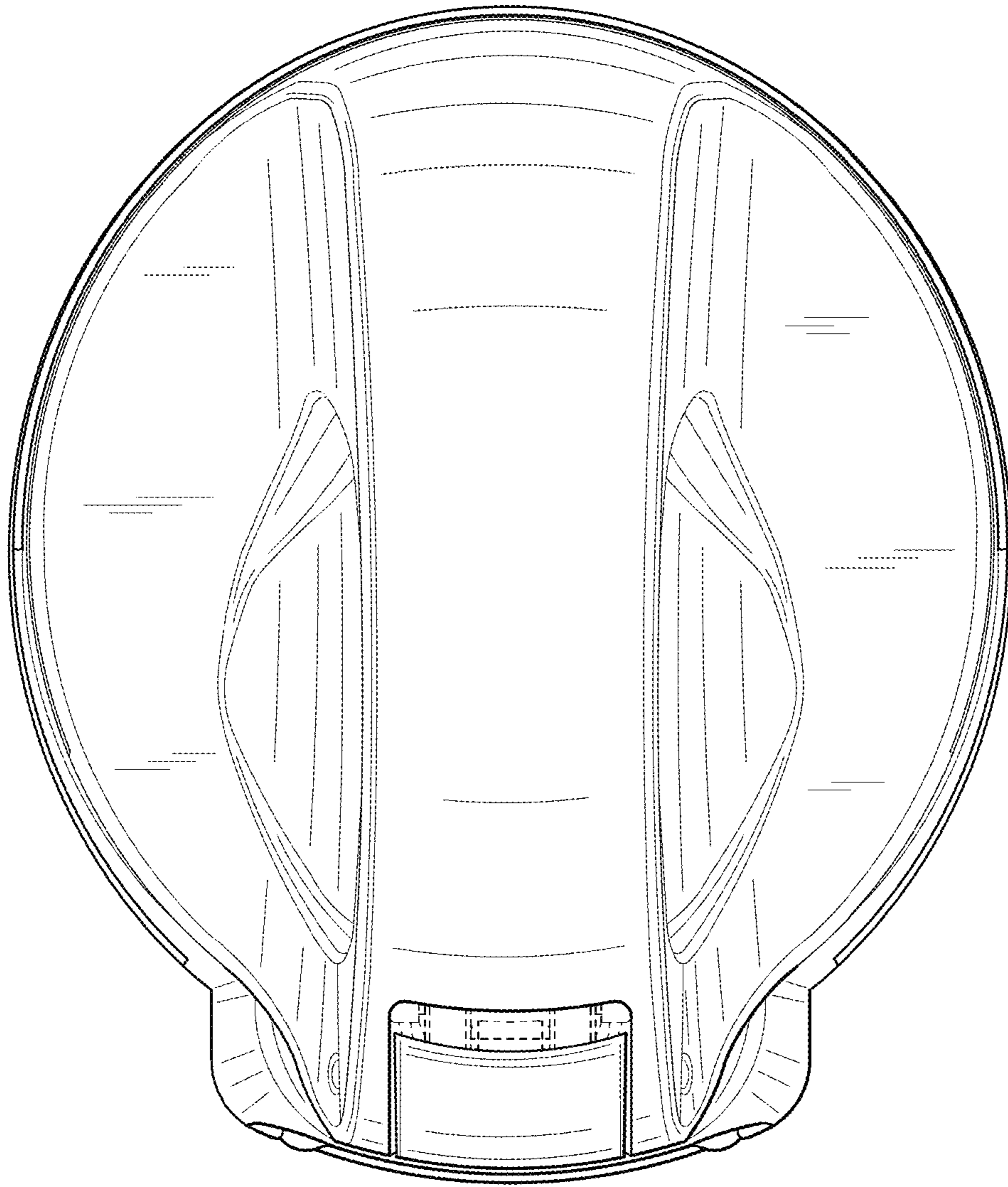

FIG. 3

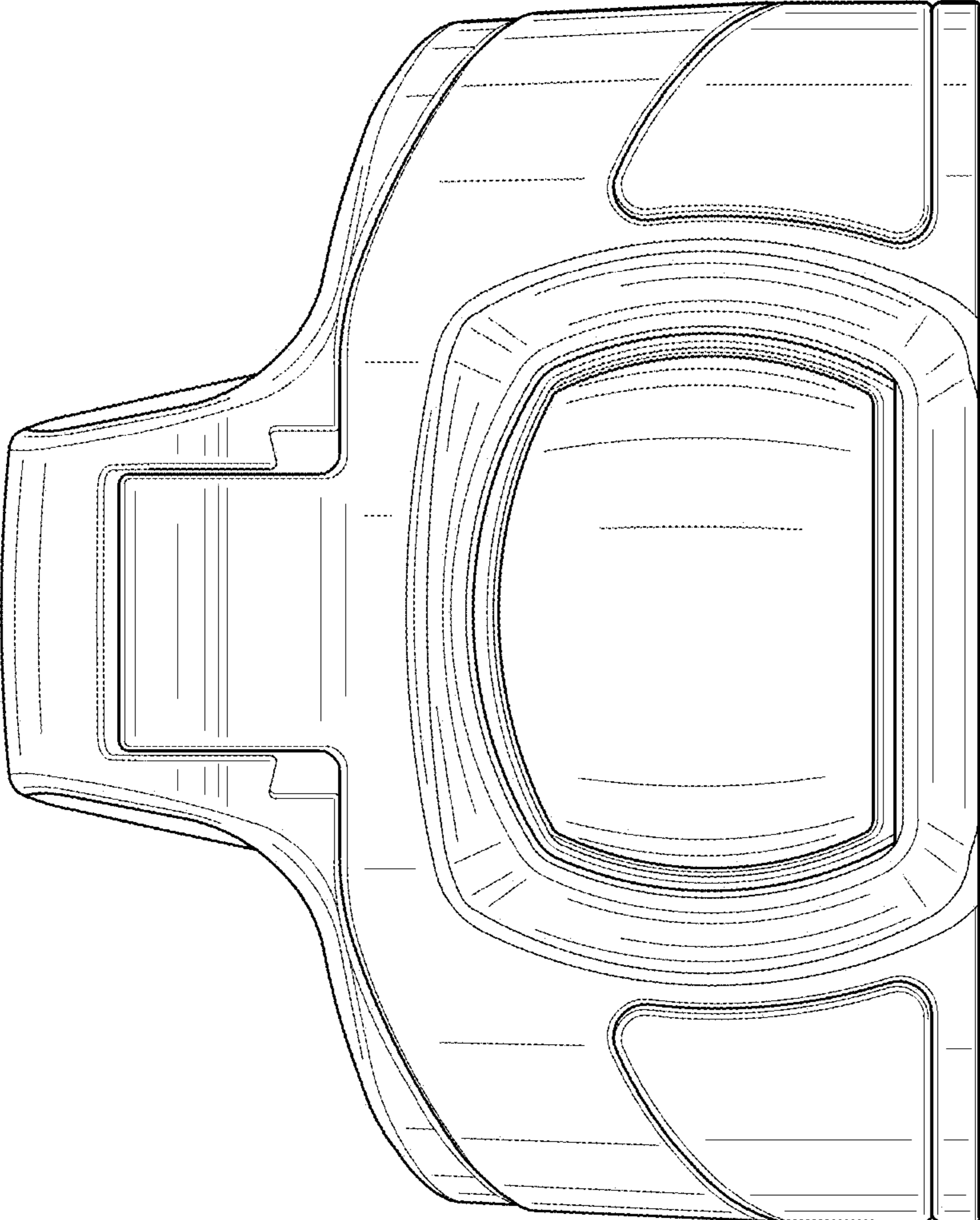

FIG. 4

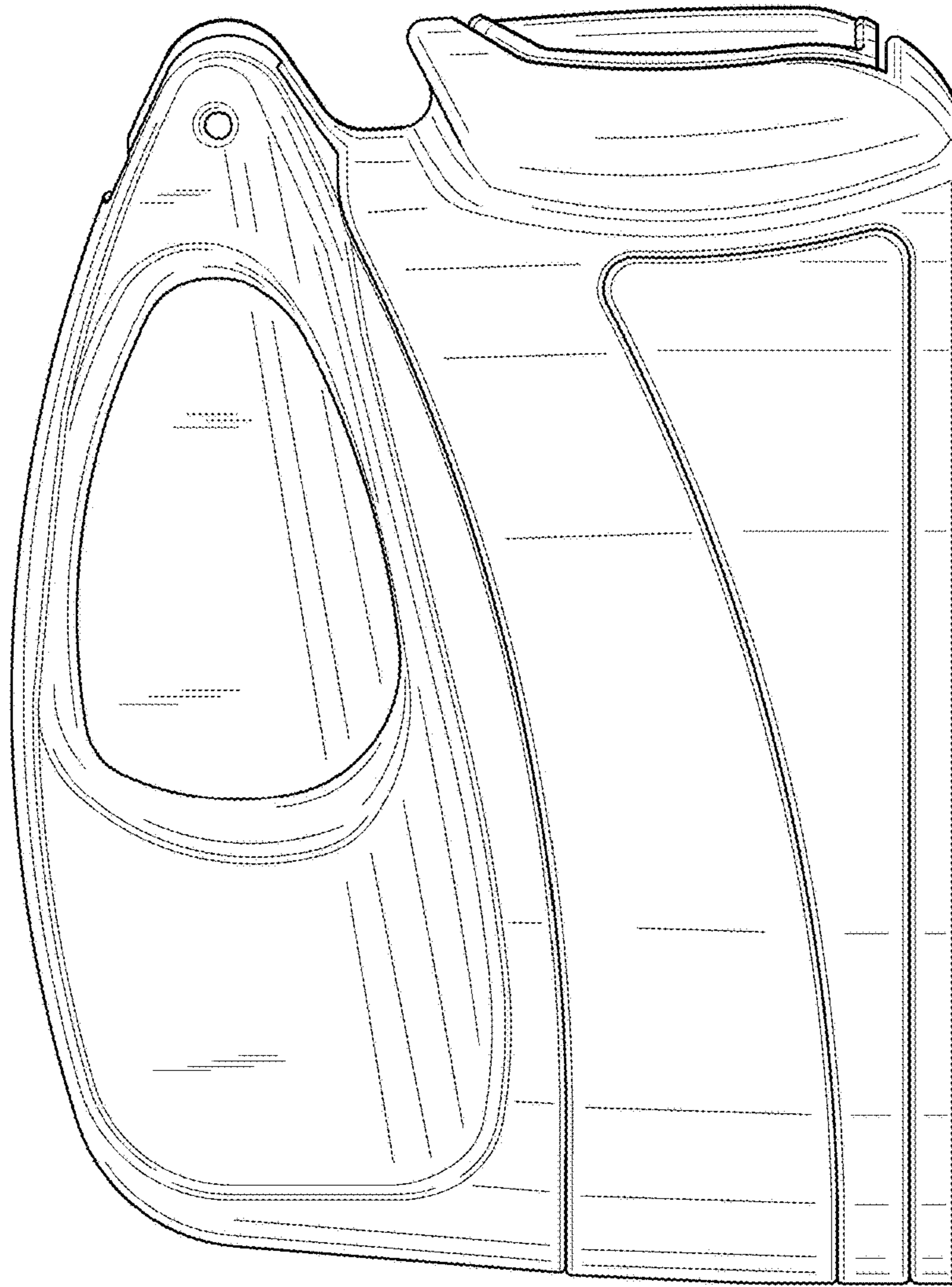

FIG. 5

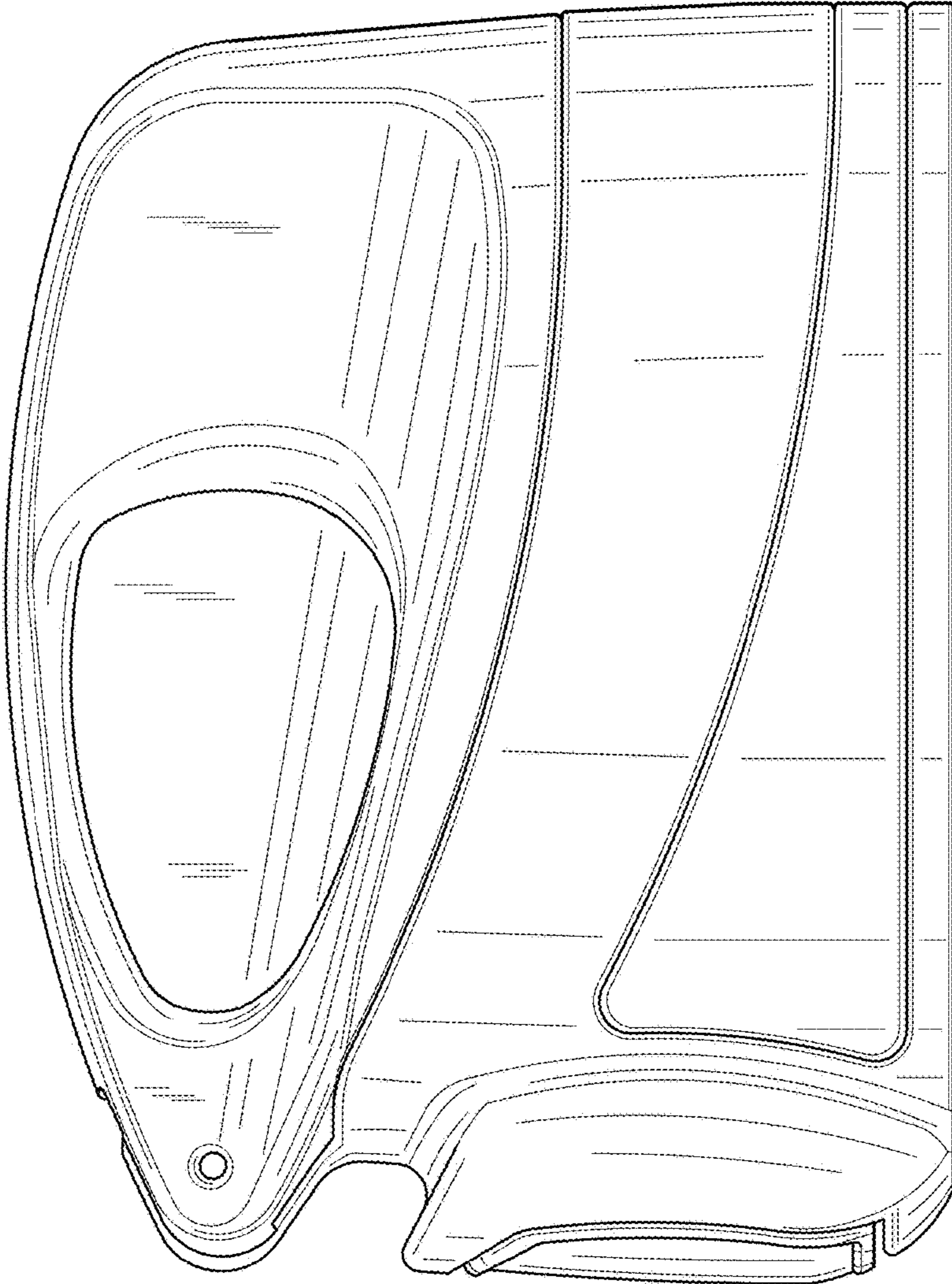

FIG. 6

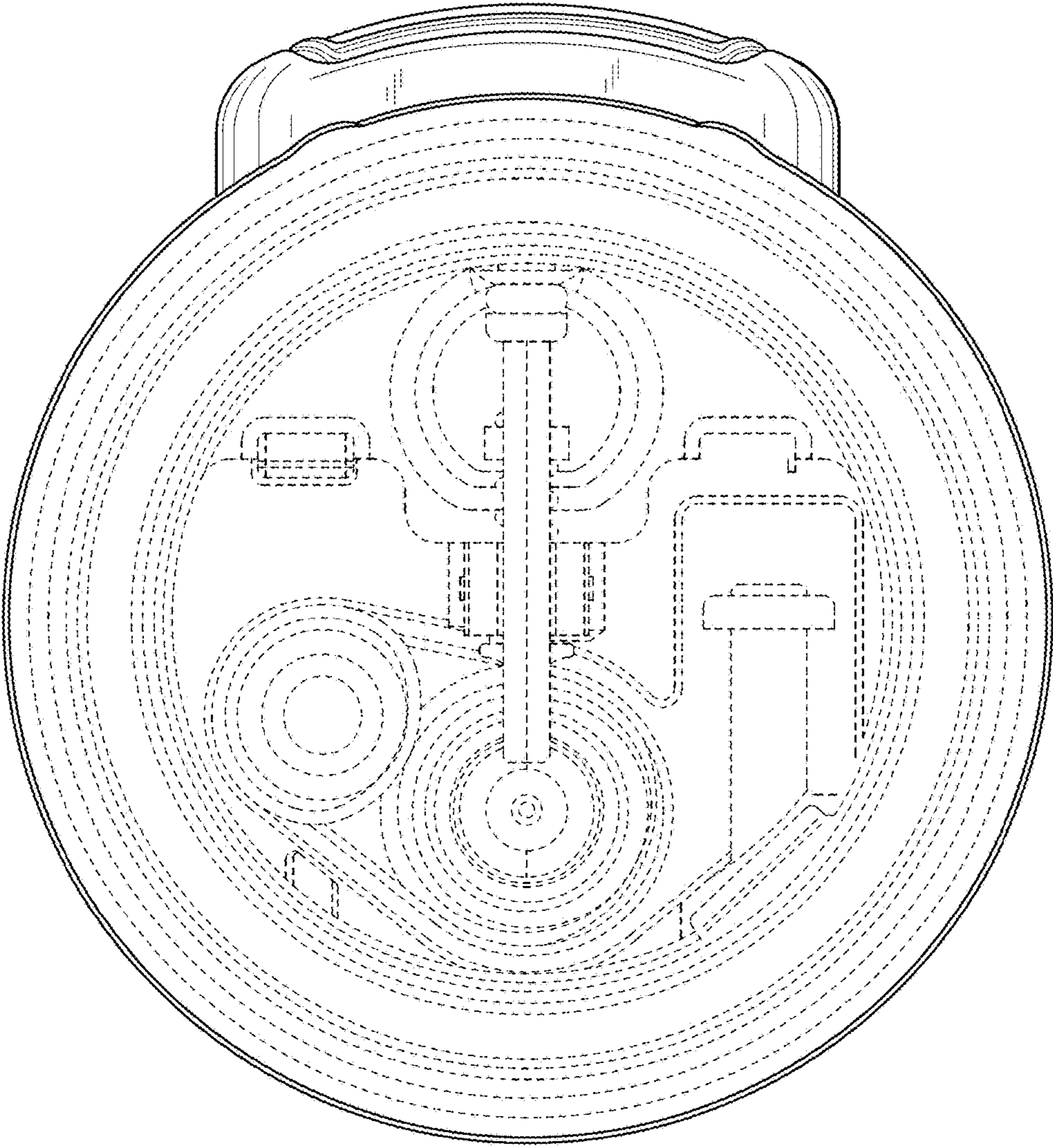

FIG. 7

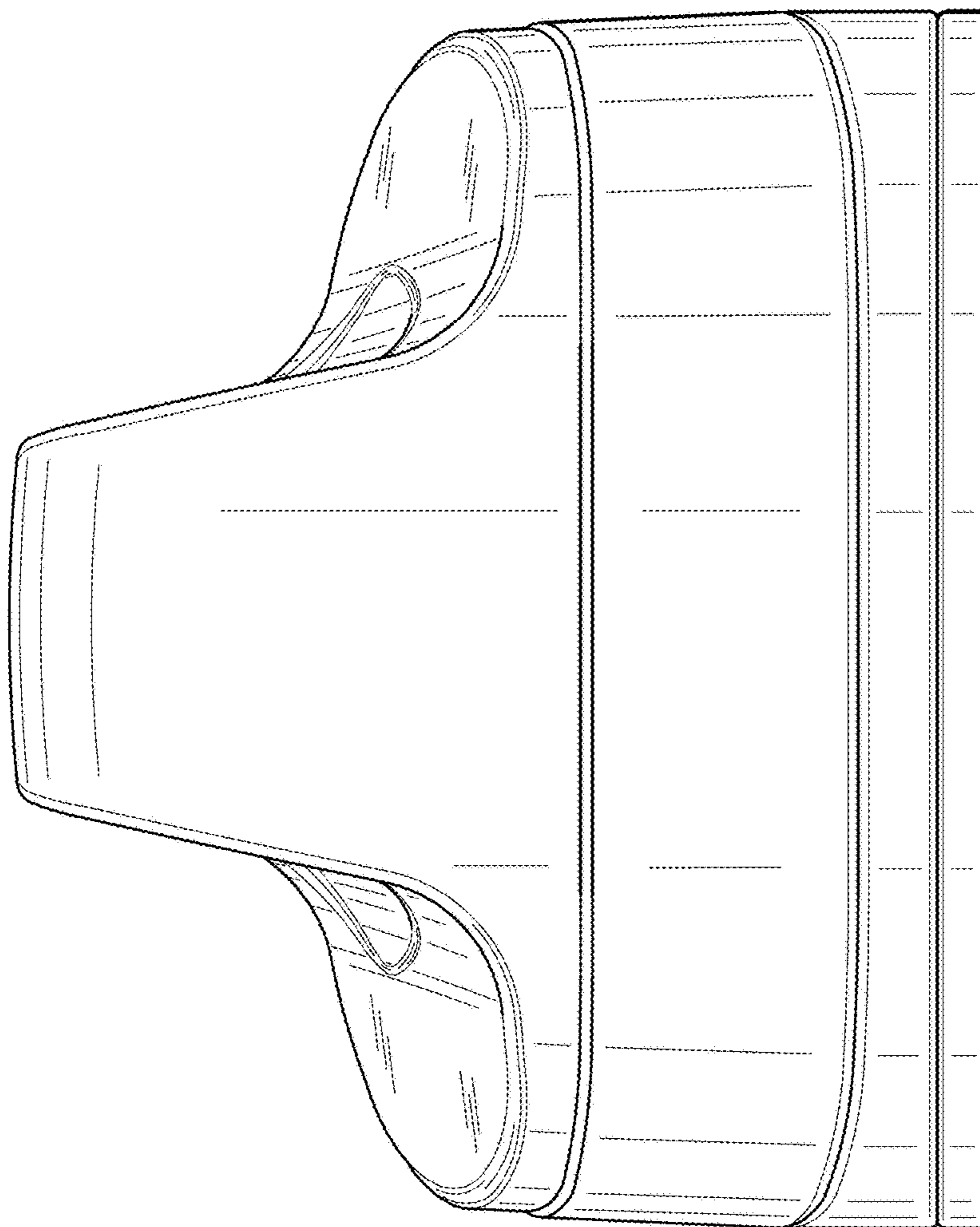

FIG. 8