



US00D840107S

(12) **United States Design Patent**
Teller et al.

(10) **Patent No.:** **US D840,107 S**

(45) **Date of Patent:** **** *Feb. 5, 2019**

(54) **COSMETIC PRODUCT CONTAINER**

(71) Applicant: **EOS PRODUCTS, LLC**, New York, NY (US)

(72) Inventors: **Jonathan Teller**, New York, NY (US);
Sanjiv Mehra, New York, NY (US);
Peter Waxman, New York, NY (US);
Joseph Speter, New York, NY (US);
Sherry Jhawar, New York, NY (US);
Hamish Campbell, New York, NY (US)

(73) Assignee: **EOS PRODUCTS, LLC**, New York, NY (US)

(*) Notice: This patent is subject to a terminal disclaimer.

(**) Term: **15 Years**

(21) Appl. No.: **29/573,625**

(22) Filed: **Aug. 8, 2016**

Related U.S. Application Data

(63) Continuation-in-part of application No. 29/479,117, filed on Jan. 13, 2014, now Pat. No. Des. 764,105, and a continuation-in-part of application No. 29/479,120, filed on Jan. 13, 2014, now Pat. No. Des. 764,106, and a continuation-in-part of application No. 29/479,121, filed on Jan. 13, 2014, now Pat. No. Des. 763,512, and a continuation-in-part of application No. 29/479,122, filed on Jan. 13, 2014, now Pat. No. Des. 764,107, and a continuation-in-part of application No. 29/486,497, filed on Mar. 31, 2014, now Pat. No. Des. 804,099, and a continuation-in-part of application No. 29/488,093, filed on Apr. 15, 2014, now Pat. No. Des. 770,685, and a continuation-in-part of application No. 29/488,094, filed on Apr. 15, 2014, now Pat. No. Des. 764,108, and a continuation-in-part of application No. 29/488,095, filed on Apr. 15, 2014, now Pat. No. Des. 764,710, and a continuation-in-part of application No. 29/488,096, filed on Apr. 15, 2014, now Pat. No. Des.

764,711, and a continuation-in-part of application No. 29/488,097, filed on Apr. 15, 2014, now Pat. No. Des. 766,512, and a continuation-in-part of application No. 29/488,098, filed on Apr. 15, 2014, now Pat. No. Des. 764,712, and a continuation-in-part of application No. 29/488,099, filed on Apr. 15, 2014, now Pat. No. Des. 777,983, and a continuation-in-part of application No. 29/488,100, filed on Apr. 15, 2014, now Pat. No. Des. 764,713, and a continuation-in-part of application No. 29/488,101, filed on Apr. 15, 2014, now Pat. No. Des. 764,714, and a continuation-in-part of application No. 29/488,102, filed on Apr. 15, 2014, now Pat. No. Des. 764,109, and a continuation-in-part of application No. 29/488,103, filed on Apr. 15, 2014, now Pat. No. Des. 764,110, and a continuation-in-part of application No. 29/488,104, filed on Apr. 16, 2014, now Pat. No. Des. 764,111, and a continuation-in-part of application No. 29/488,846, filed on Apr. 23, 2014, now Pat. No. Des. 771,873, and a continuation-in-part of application No. 29/488,847, filed on Apr. 23, 2014, now Pat. No. Des. 764,112, and a continuation-in-part of application No. 29/488,848, filed on Apr. 23, 2014, now Pat. No. Des. 764,113, and a continuation-in-part of application No. 29/488,849, filed on Apr. 23, 2014, now Pat. No. Des. 764,114, and a continuation-in-part of application No. 29/488,850, filed on Apr. 23, 2014, now Pat. No. Des. 769,533, and a continuation-in-part of application No. 29/570,374, filed on Jul. 7, 2016, which is a continuation-in-part of application No. 29/479,116, filed on Jan. 13, 2014, now Pat. No. Des. 762,329.

(51) **LOC (11) CI.** **28-03**

(52) **U.S. CI.**
USPC **D28/82**; D28/88; D9/519; D9/552;
D9/554

(58) **Field of Classification Search**
USPC D28/85-91, 82, 76-79, 4-7, 8.1, 8.2, 9;
D9/502, 570, 503, 504, 519, 552, 554,
D9/557, 564, 566, 567, 600, 726, 601,
D9/551, 521, 416, 529, 438, 435;
D24/101, 102; D1/127, 130; D5/43, 44,
D5/56, 59, 60, 62, 55; 132/316, 317,
132/318, 320; 206/581, 823, 385;
D3/265, 270, 271.1; 424/467; D14/489

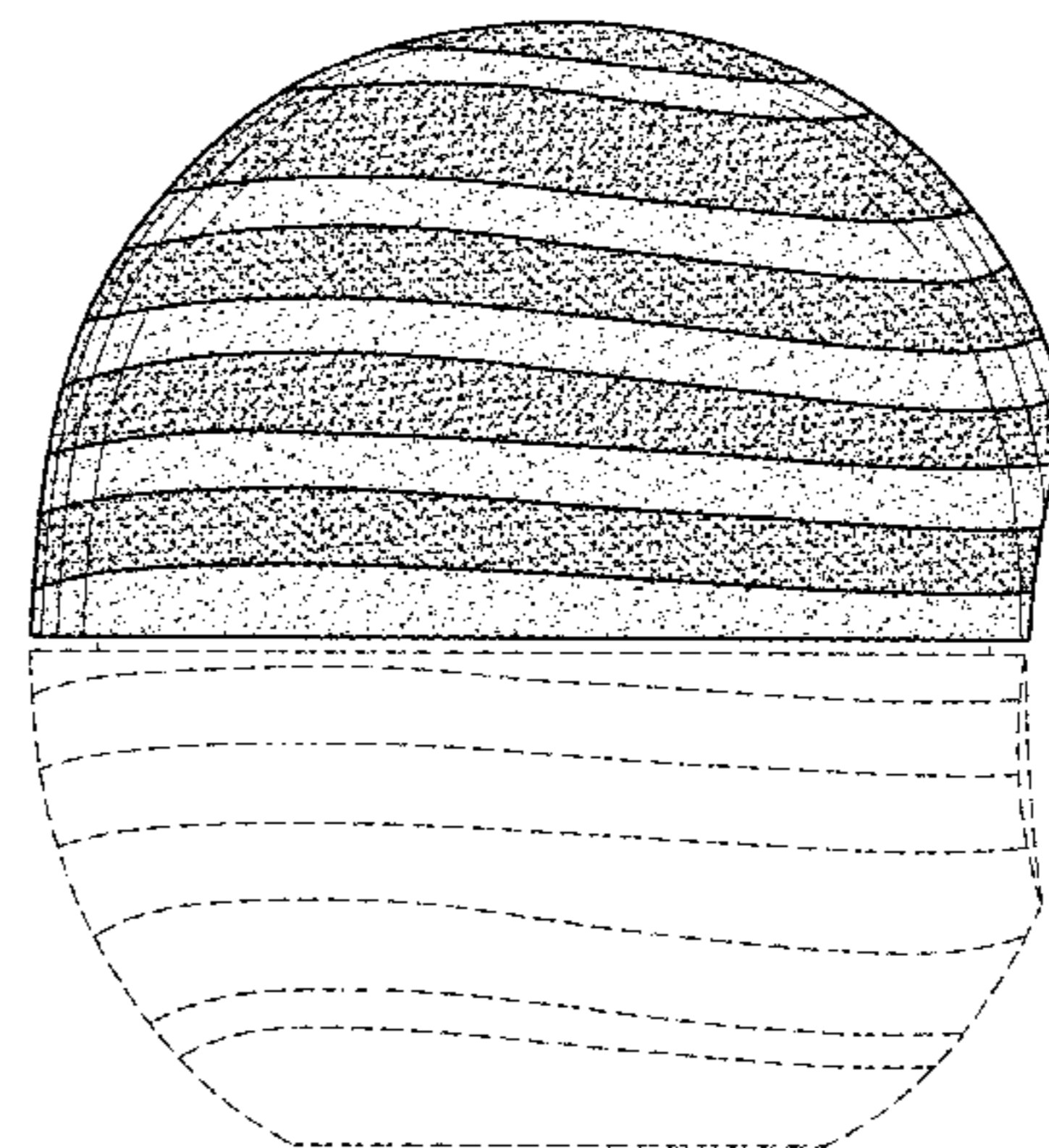
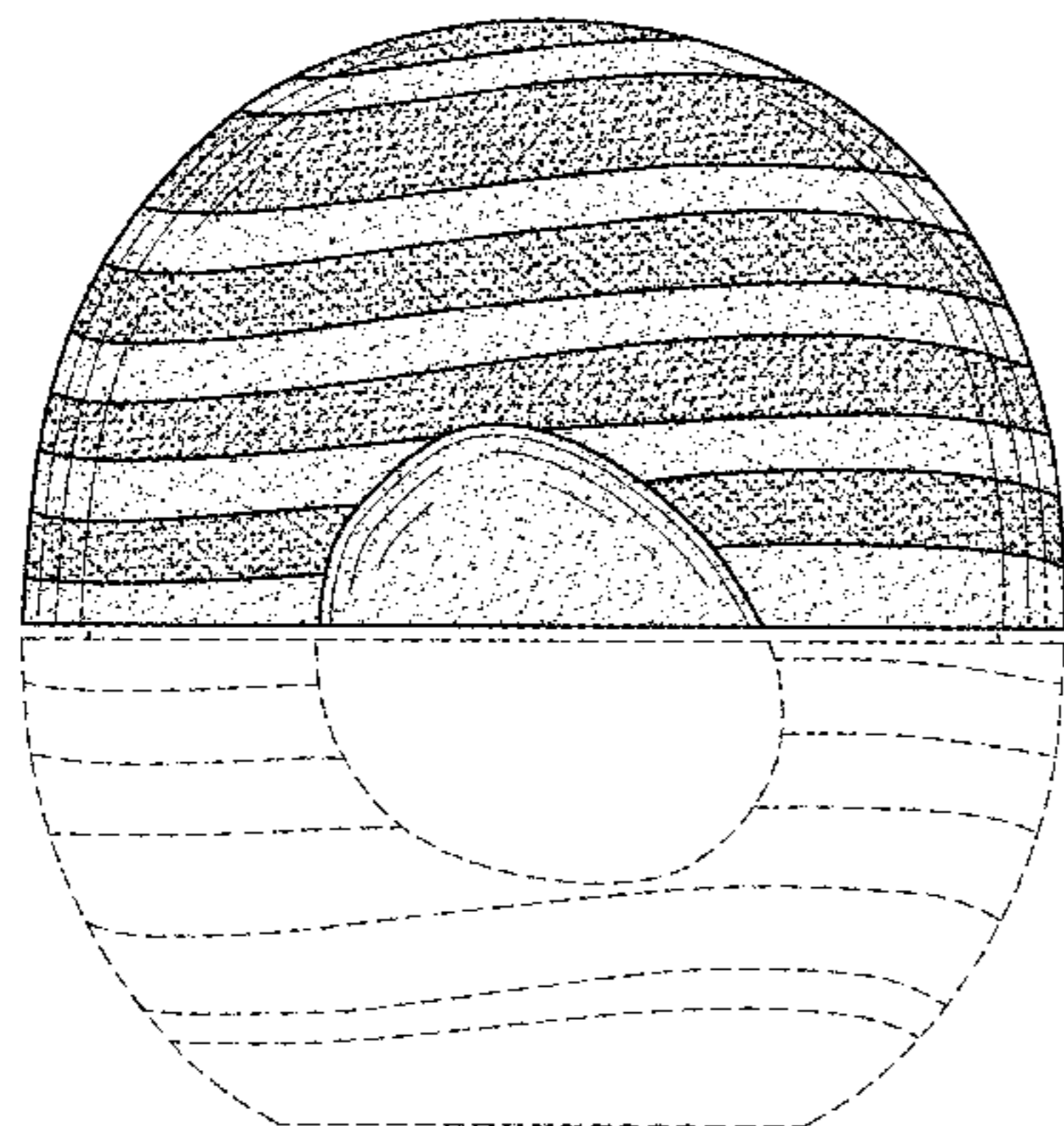

CPC ... B65D 1/00; B65D 3/00; B65D 5/00; B65D 11/00; B65D 25/00; B65D 81/00
See application file for complete search history.

(56) **References Cited**

U.S. PATENT DOCUMENTS

D16,159 S * 7/1885 Atterbury D9/519
1,852,455 A * 4/1932 Friedman A45D 33/00
132/293
2,745,642 A * 5/1956 Hermann A47J 43/24
206/1.5
3,167,079 A * 1/1965 Weil B08B 3/044
134/135
D206,463 S * 12/1966 George D9/502
3,292,840 A * 12/1966 Schmidt B65D 11/02
206/776
3,494,515 A * 2/1970 Fattori B65D 11/02
222/548
D276,282 S 11/1984 Burg
4,765,501 A * 8/1988 Kao B65D 11/02
220/4.21
D309,419 S 7/1990 Berg
5,044,496 A * 9/1991 Tanaka G11B 23/0233
206/387.1
D321,129 S * 10/1991 Giuseppe D23/366
D322,558 S * 12/1991 Halm D23/366
D326,411 S * 5/1992 Wefler D9/552
D358,231 S * 5/1995 Liu D28/82
D378,275 S * 3/1997 Rusnock D9/545
D380,672 S * 7/1997 Rowe D9/529
D382,207 S * 8/1997 Rowe D9/570
D396,382 S * 7/1998 Hsu D7/599
D403,123 S * 12/1998 Sgariboldi D28/76
6,193,427 B1 * 2/2001 Benguigui A45D 40/16
206/823
D443,826 S * 6/2001 Gnann D9/537
D446,616 S 8/2001 Denney
D447,305 S * 8/2001 Hughes D34/1
D450,882 S * 11/2001 Colwell D28/4
D452,586 S * 12/2001 Look D19/66
D452,588 S * 12/2001 Look D19/66
D454,664 S * 3/2002 Look D19/66
6,391,972 B1 * 5/2002 Hatakeyama B32B 27/08
428/34.7
D465,609 S * 11/2002 Jackel-Marken D28/4
D465,733 S * 11/2002 Hill D9/519
D469,697 S * 2/2003 Herrin D9/538
D472,014 S * 3/2003 Jackel-Marken D28/4
D474,021 S * 5/2003 Lenaerts D3/273
D512,199 S * 12/2005 Ibanez D1/129
D516,431 S * 3/2006 Vintro D9/521
D518,382 S * 4/2006 McGuinness D28/89
D521,868 S * 5/2006 Arima D9/502
D525,437 S * 7/2006 Leisch D5/53
D537,563 S * 2/2007 Taniguchi D28/4
D541,052 S 4/2007 Miller et al.
D552,997 S * 10/2007 Blasko D9/516
D554,529 S * 11/2007 Green D9/726
D564,900 S * 3/2008 Green D9/504
D570,219 S * 6/2008 Blasko D9/516
D572,145 S * 7/2008 Knapp D9/548
D579,213 S * 10/2008 Aipa D5/43
D592,064 S * 5/2009 Kilany D9/519
D592,463 S * 5/2009 Ehrenhaus D7/613
D592,512 S * 5/2009 Dubitsky D9/516
D599,560 S * 9/2009 Sharma D5/59
D609,107 S * 2/2010 Dubitsky D9/538
D612,245 S * 3/2010 Canamasas Puigbo D9/519
D614,452 S * 4/2010 Ablo D7/628
D622,597 S * 8/2010 Dabrowski D9/538
D622,604 S * 8/2010 Wheeler D9/556
D622,968 S 9/2010 Mercer
D625,469 S * 10/2010 Dubitsky D28/84
D631,204 S * 1/2011 Dubitsky D28/82
D635,371 S * 4/2011 Schilling D21/839
D639,176 S * 6/2011 Paulo Caldas D9/550

D644,939 S * 9/2011 Teller D9/726
D650,241 S * 12/2011 Ehrenhaus D7/628
D650,994 S 12/2011 Sheehan et al.
D656,741 S * 4/2012 Snyder D5/60
D656,798 S * 4/2012 Guastafeste D7/628
D662,652 S * 6/2012 Browder D26/134
D663,126 S 7/2012 Lapinid et al.
D672,965 S 12/2012 Sheehan et al.
D672,966 S 12/2012 Sheehan et al.
D672,967 S 12/2012 Sheehan et al.
D678,685 S 3/2013 Kase et al.
D681,278 S * 4/2013 Schlatter D28/82
8,444,337 B2 * 5/2013 Teller A45D 40/00
206/385
D688,000 S * 8/2013 Johnson D28/4
D689,366 S * 9/2013 Kohne D9/504
D695,552 S * 12/2013 Gatto D5/56
D705,988 S * 5/2014 Scott D28/7
D708,726 S * 7/2014 Gordon D23/356
D708,790 S * 7/2014 Schlatter D28/89
D710,544 S * 8/2014 Shen D28/77
D715,142 S * 10/2014 Allen D5/56
D726,028 S * 4/2015 Thompson D28/7
D726,219 S * 4/2015 Chaudhri D14/489
D735,414 S * 7/2015 Schlatter D28/85
D762,329 S * 7/2016 Teller D28/82
D763,512 S * 8/2016 Teller D28/82
D764,105 S * 8/2016 Teller D28/82
D764,106 S * 8/2016 Teller D28/82
D764,107 S * 8/2016 Teller D28/82
D764,108 S * 8/2016 Teller D28/82
D764,109 S * 8/2016 Teller D28/82
D764,110 S * 8/2016 Teller D28/82
D764,111 S 8/2016 Teller et al.
D764,112 S 8/2016 Teller et al.
D764,113 S 8/2016 Teller et al.
D764,114 S 8/2016 Teller et al.
D764,710 S 8/2016 Teller et al.
D764,711 S 8/2016 Teller et al.
D764,712 S 8/2016 Teller et al.
D764,713 S 8/2016 Teller et al.
D764,714 S 8/2016 Teller et al.
D766,512 S 9/2016 Teller et al.
D769,533 S 10/2016 Teller et al.
D770,685 S 11/2016 Teller et al.
D771,873 S 11/2016 Teller et al.
D777,983 S 1/2017 Teller et al.
D804,099 S 11/2017 Teller et al.
D813,480 S 3/2018 Burazin
D819,983 S 6/2018 Barran et al.
2007/0017915 A1 1/2007 Weder et al.
2011/0247144 A1 10/2011 Oh et al.

FOREIGN PATENT DOCUMENTS

JP 1136041 3/2002
JP 2004-321410 11/2004

OTHER PUBLICATIONS

U.S. Appl. No. 29/479,119, filed Jan. 2014, Teller et al.
U.S. Appl. No. 29/486,497, filed Mar. 2014, Teller et al.
U.S. Appl. No. 29/488,099, filed Apr. 2014, Teller et al.
U.S. Appl. No. 29/570,374, filed Jul. 2016, Teller et al.
U.S. Appl. No. 29/574,404, filed Aug. 2016, Teller et al.
U.S. Appl. No. 29/574,428, filed Aug. 2016, Teller et al.
U.S. Appl. No. 29/574,429, filed Aug. 2016, Teller et al.
U.S. Appl. No. 29/574,431, filed Aug. 2016, Teller et al.
SIPO Office Action issued Jul. 17, 2014 in connection with CN Appl. No. 201080063211.X citing JP 2004-321410A and JP 1136041S (listed separately).
U.S. Appl. No. 29/479,116, filed Jan. 13, 2014, now U.S. Pat. No. D. 762,329.
U.S. Appl. No. 29/479,117, filed Jan. 13, 2014, now U.S. Pat. No. D. 764,105.
U.S. Appl. No. 29/479,120, filed Jan. 13, 2014, now U.S. Pat. No. D. 764,106.

U.S. Appl. No. 29/479,121, filed Jan. 13, 2014, now U.S. Pat. No. D. 763,512.
U.S. Appl. No. 29/479,122, filed Jan. 13, 2014, now U.S. Pat. No. D. 764,107.
U.S. Appl. No. 29/486,497, filed Mar. 31, 2014, abandoned.
U.S. Appl. No. 29/488,093, filed Apr. 15, 2014, now U.S. Pat. No. D. 770,685.
U.S. Appl. No. 29/488,094, filed Apr. 15, 2014, now U.S. Pat. No. D. 764,108.
U.S. Appl. No. 29/488,095, filed Apr. 15, 2014, now U.S. Pat. No. D. 764,710.
U.S. Appl. No. 29/488,096, filed Apr. 15, 2014, now U.S. Pat. No. D. 764,711.
U.S. Appl. No. 29/488,097, filed Apr. 15, 2014, now U.S. Pat. No. D. 766,512.
U.S. Appl. No. 29/488,098, filed Apr. 15, 2014, now U.S. Pat. No. D. 764,712.
U.S. Appl. No. 29/488,099, filed Apr. 15, 2014, pending.
U.S. Appl. No. 29/488,100, filed Apr. 15, 2014, now U.S. Pat. No. D. 764,713.
U.S. Appl. No. 29/488,101, filed Apr. 15, 2014, now U.S. Pat. No. D. 764,714.
U.S. Appl. No. 29/488,102, filed Apr. 15, 2014, now U.S. Pat. No. D. 764,109.
U.S. Appl. No. 29/488,103, filed Apr. 15, 2014, now U.S. Pat. No. D. 764,110.
U.S. Appl. No. 29/488,104, filed Apr. 16, 2014, now U.S. Pat. No. D. 764,111.
U.S. Appl. No. 29/488,846, filed Apr. 23, 2014, now U.S. Pat. No. D. 771,873.
U.S. Appl. No. 29/488,847, filed Apr. 23, 2014, now U.S. Pat. No. D. 764,112.
U.S. Appl. No. 29/488,848, filed Apr. 23, 2014, now U.S. Pat. No. D. 764,113.
U.S. Appl. No. 29/488,849, filed Apr. 23, 2014, now U.S. Pat. No. D. 764,114.
U.S. Appl. No. 29/488,850, filed Apr. 23, 2014, now U.S. Pat. No. D. 769,533.
U.S. Appl. No. 29/570,374, filed Jul. 7, 2016, pending.
U.S. Appl. No. 29/479,119, filed Jan. 13, 2014, abandoned.
U.S. Appl. No. 29/574,404, filed Aug. 15, 2016, pending.

U.S. Appl. No. 29/574,428, filed Aug. 15, 2016, pending.
U.S. Appl. No. 29/574,429, filed Aug. 15, 2016, pending.
U.S. Appl. No. 29/574,431, filed Aug. 15, 2016, pending.
U.S. Appl. No. 29/488,093, dated Apr. 2014, Teller et al.
U.S. Appl. No. 29/488,846, dated Apr. 2014, Teller et al.
U.S. Appl. No. 29/488,850, dated Apr. 2014, Teller et al.

* cited by examiner

Primary Examiner — Marianne N Pandozzi
Assistant Examiner — Jae Liang
(74) *Attorney, Agent, or Firm* — Martin & Ferraro, LLP

(57) **CLAIM**

The ornamental design for cosmetic product container, as shown and described.

DESCRIPTION

FIG. 1 is a front elevational view of a cosmetic product container;
FIG. 2 is a left side elevational view of the cosmetic product container of FIG. 1;
FIG. 3 is a right side elevational view of the cosmetic product container of FIG. 1;
FIG. 4 is a rear elevational view of the cosmetic product container of FIG. 1;
FIG. 5 is a top plan view of the cosmetic product container of FIG. 1; and,
FIG. 6 is a bottom plan view of the cosmetic product container of FIG. 1.
The broken lines are included for the purpose of illustrating portions of the cosmetic product container that form no part of the claimed design.
The stippling in FIGS. 1-6 shows contrast in appearance.

1 Claim, 3 Drawing Sheets

FIG. 1

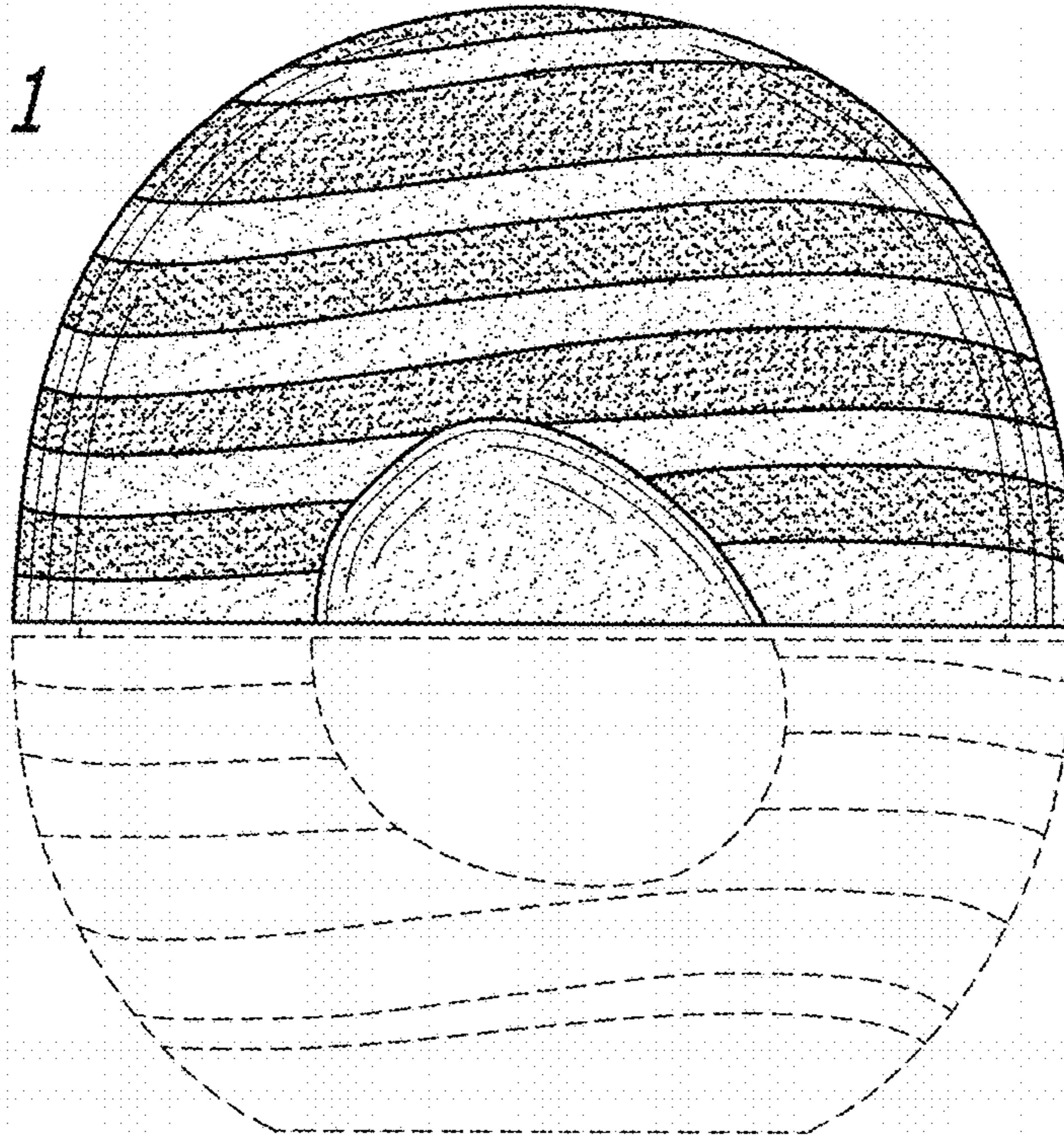

FIG. 2

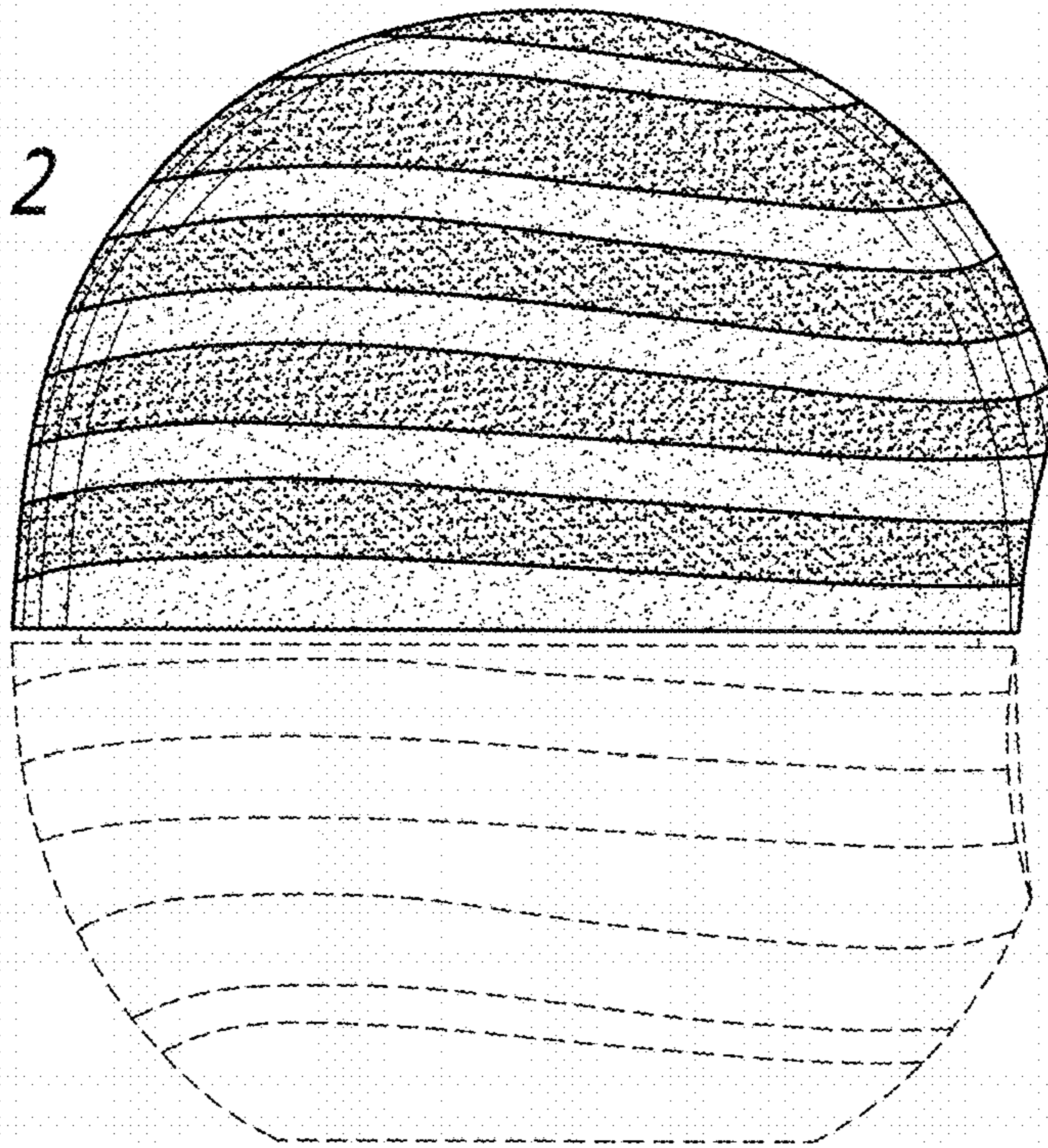

FIG. 3

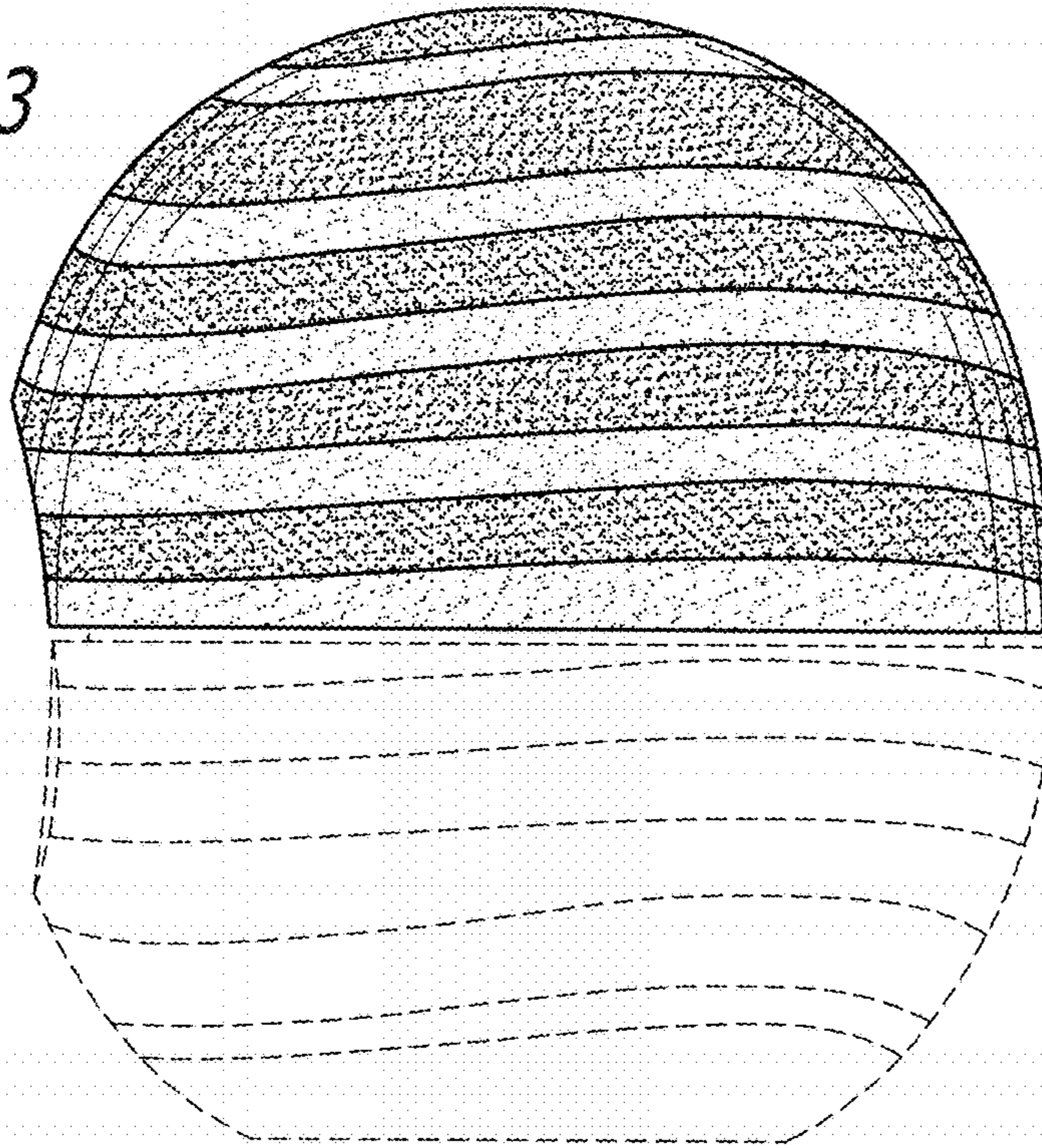

FIG. 4

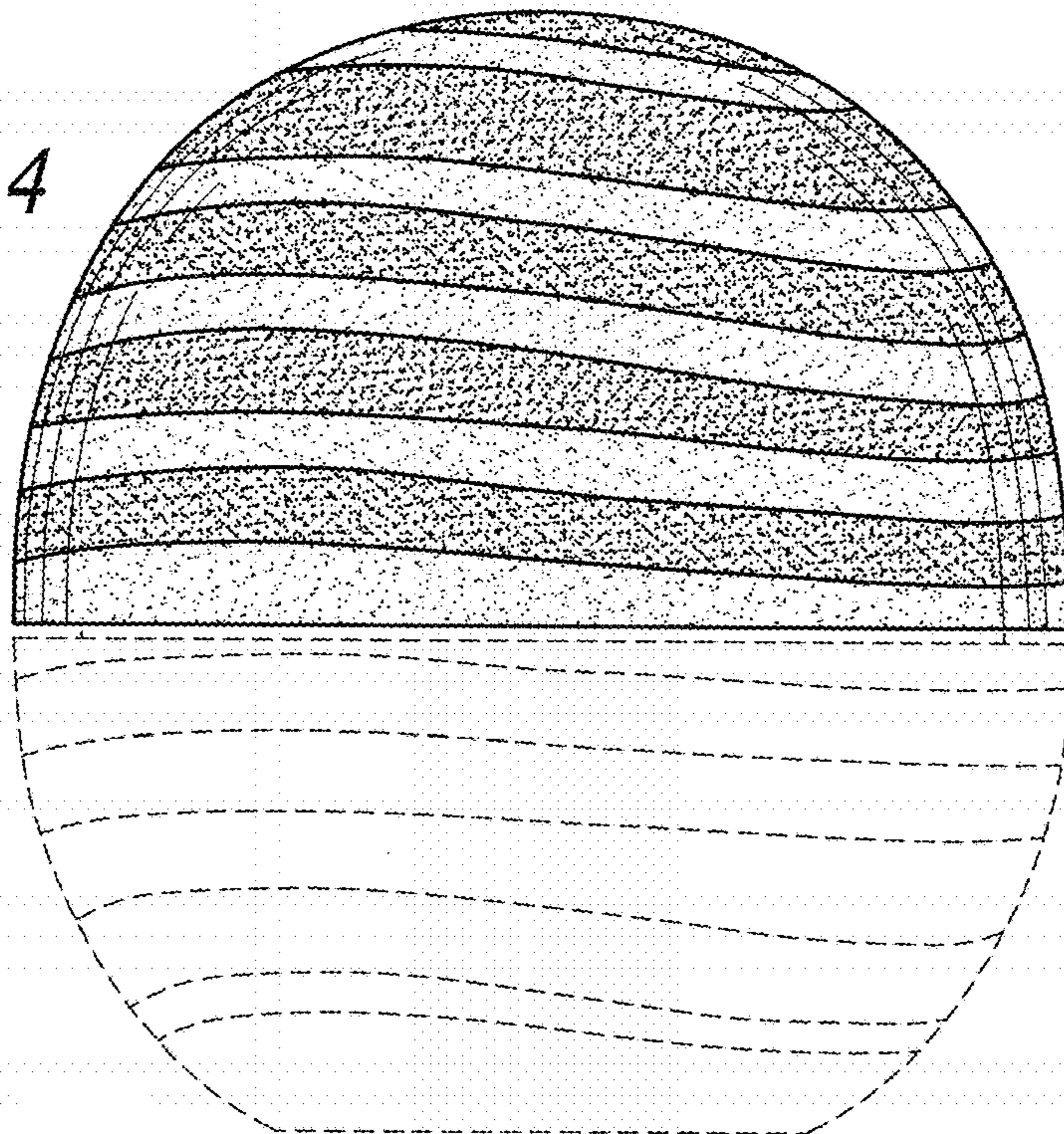

FIG. 5

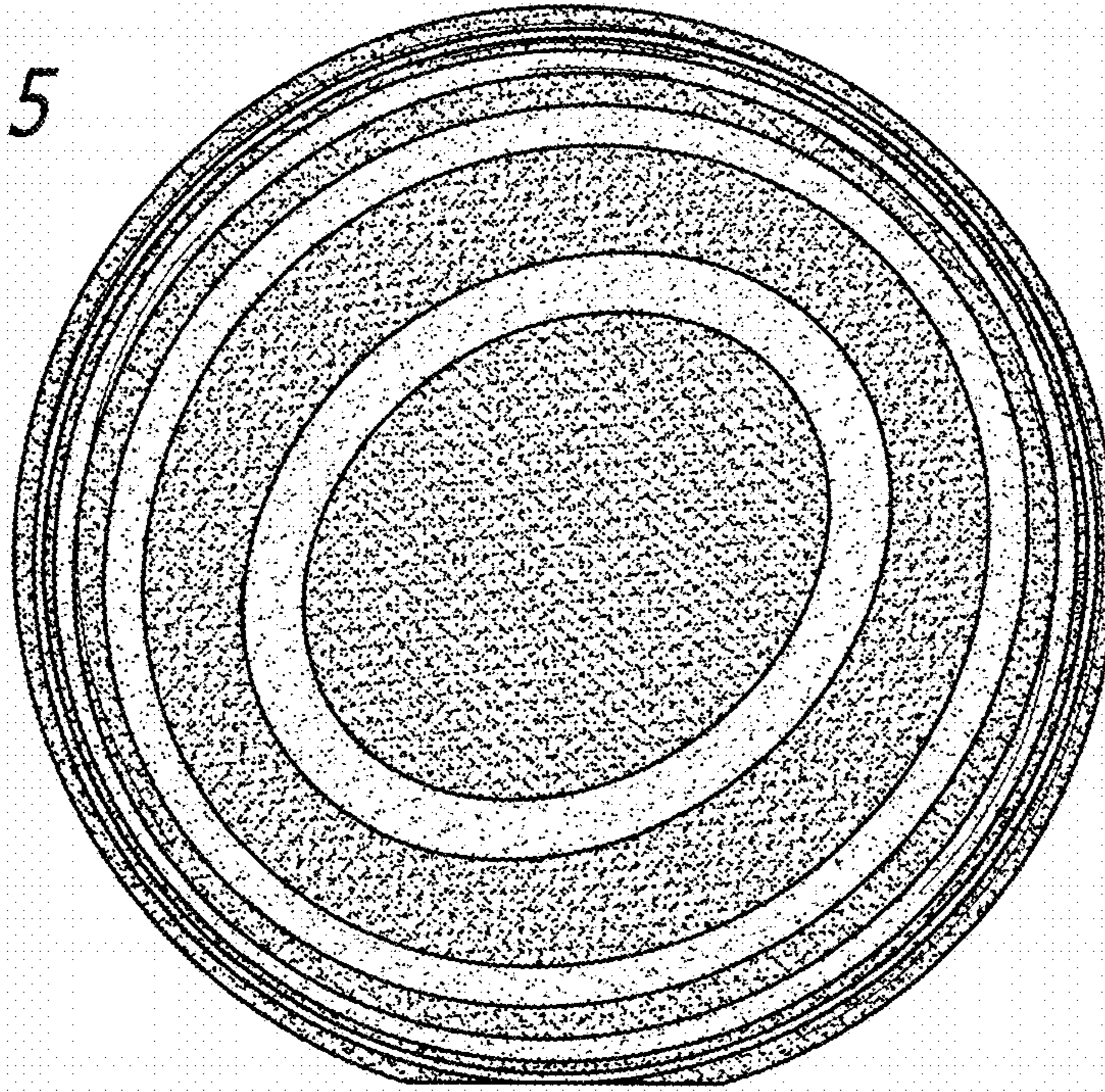

FIG. 6

