



US00D840071S

(12) **United States Design Patent**  
**Yuan**

(10) **Patent No.:** **US D840,071 S**

(45) **Date of Patent:** **\*\* Feb. 5, 2019**

(54) **WORK LIGHT**

(71) Applicant: **Ningbo Auma Electric Technology Co., Ltd.**, Yuyao, Zhejiang Province (CN)

(72) Inventor: **Wei-Wu Yuan**, Yuyao (CN)

(73) Assignee: **Ningbo Auma Electric Technology Co., Ltd.**, Yuyao (CN)

(\*\*) Term: **15 Years**

(21) Appl. No.: **29/571,842**

(22) Filed: **Jul. 22, 2016**

(51) **LOC (11) Cl.** ..... **26-02**

(52) **U.S. Cl.**  
USPC ..... **D26/37**

(58) **Field of Classification Search**

USPC ..... D26/37, 46, 38, 49, 51, 44, 62, 63, 65  
CPC ..... F21L 2003/00; F21L 4/00; F21L 4/005;  
F21L 4/02; F21L 4/025; F21L 4/027;  
F21L 4/04; F21L 4/08; F21L 2005/00;  
F21L 7/00; F21L 11/00; F21L 13/00;  
F21L 13/04; F21L 13/08; F21L 14/02;  
F21L 17/00; F21L 19/00

See application file for complete search history.

(56) **References Cited**

**U.S. PATENT DOCUMENTS**

D275,523 S \* 9/1984 Ader ..... D26/39  
D549,859 S \* 8/2007 Kovacik ..... D26/37

D608,038 S \* 1/2010 Chan ..... D26/60  
D611,632 S \* 3/2010 Diehl ..... D26/50  
D629,131 S \* 12/2010 Seal ..... D26/60  
D744,139 S \* 11/2015 Itoh ..... D26/63  
D750,307 S \* 2/2016 Borring ..... D26/63  
D766,481 S \* 9/2016 Lipson ..... D26/63  
D779,092 S \* 2/2017 Xu ..... D26/37

\* cited by examiner

*Primary Examiner* — Lakiya G Rogers

*Assistant Examiner* — Carissa C Fitts

(74) *Attorney, Agent, or Firm* — Gokalp Bayramoglu

(57) **CLAIM**

The ornamental design for a work light, as shown and described.

**DESCRIPTION**

FIG. 1 is a first perspective view of the work light, showing my new design;  
FIG. 2 is a second perspective view thereof;  
FIG. 3 is a front elevational view thereof;  
FIG. 4 is a rear elevational view thereof;  
FIG. 5 is a left side elevational view thereof;  
FIG. 6 is a right side elevational view thereof;  
FIG. 7 is a top plan view thereof; and,  
FIG. 8 is a bottom plan view thereof.  
The broken lines depict portions of the work light that form no part of the claimed design.

**1 Claim, 8 Drawing Sheets**

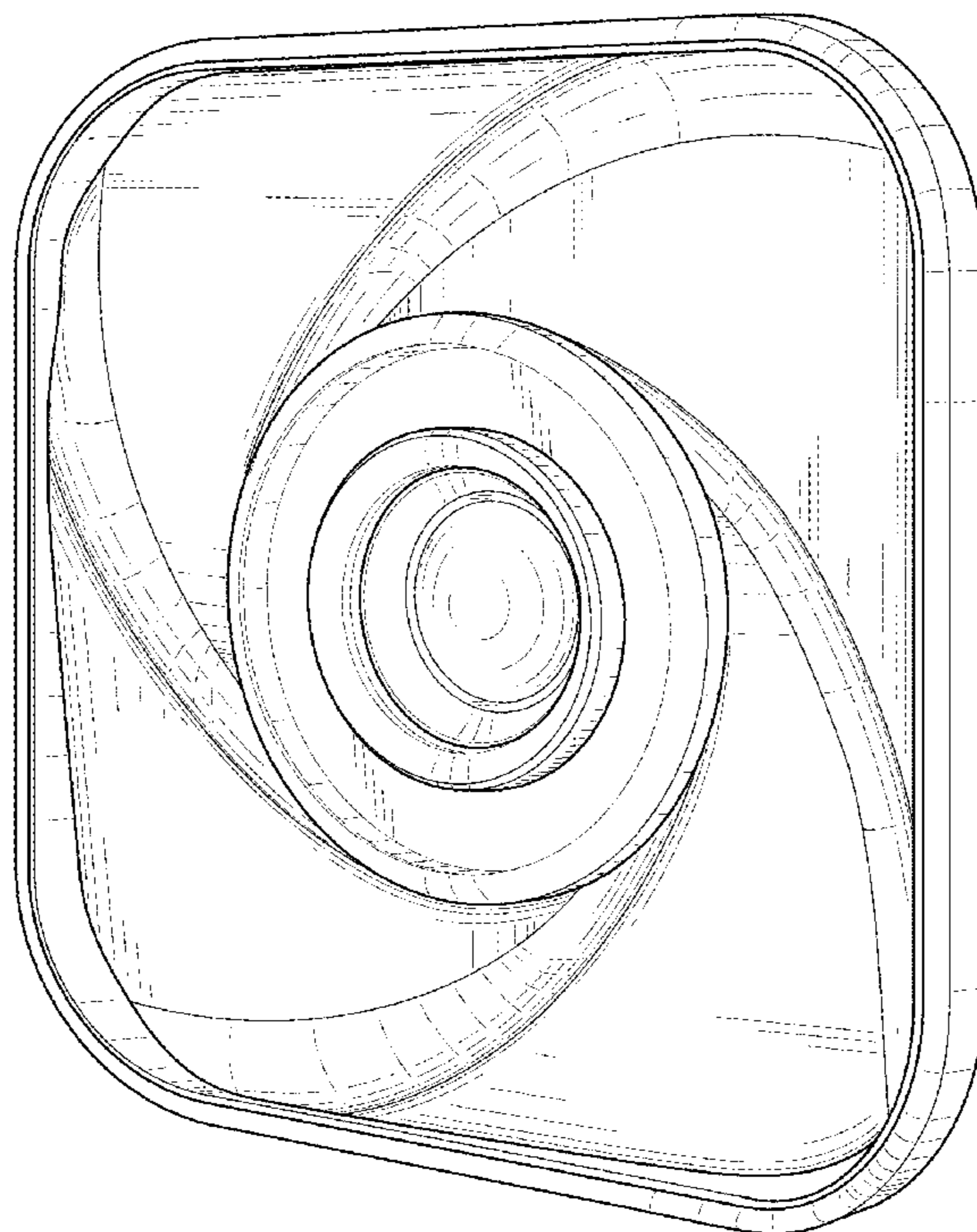

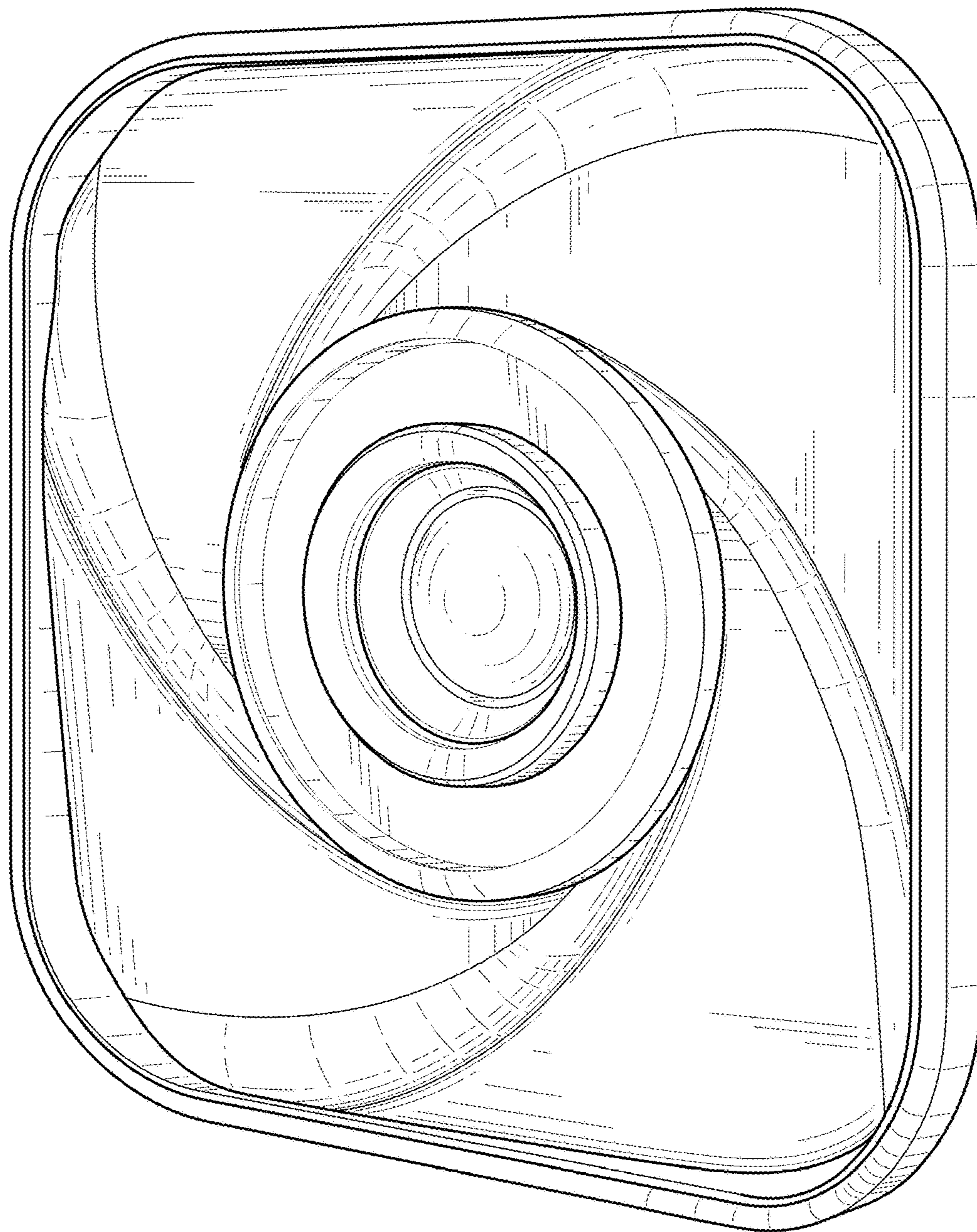

Fig. 1

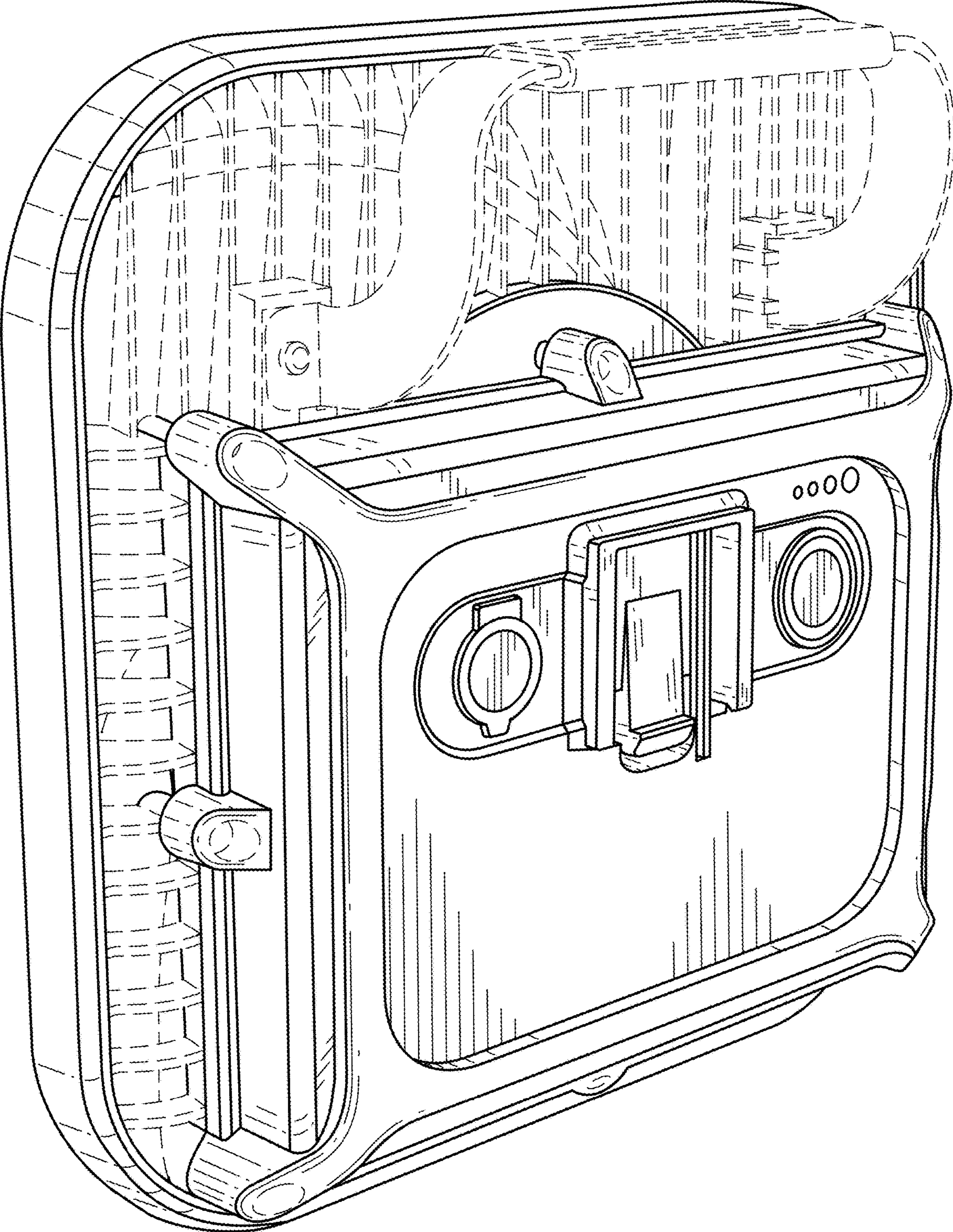

Fig. 2

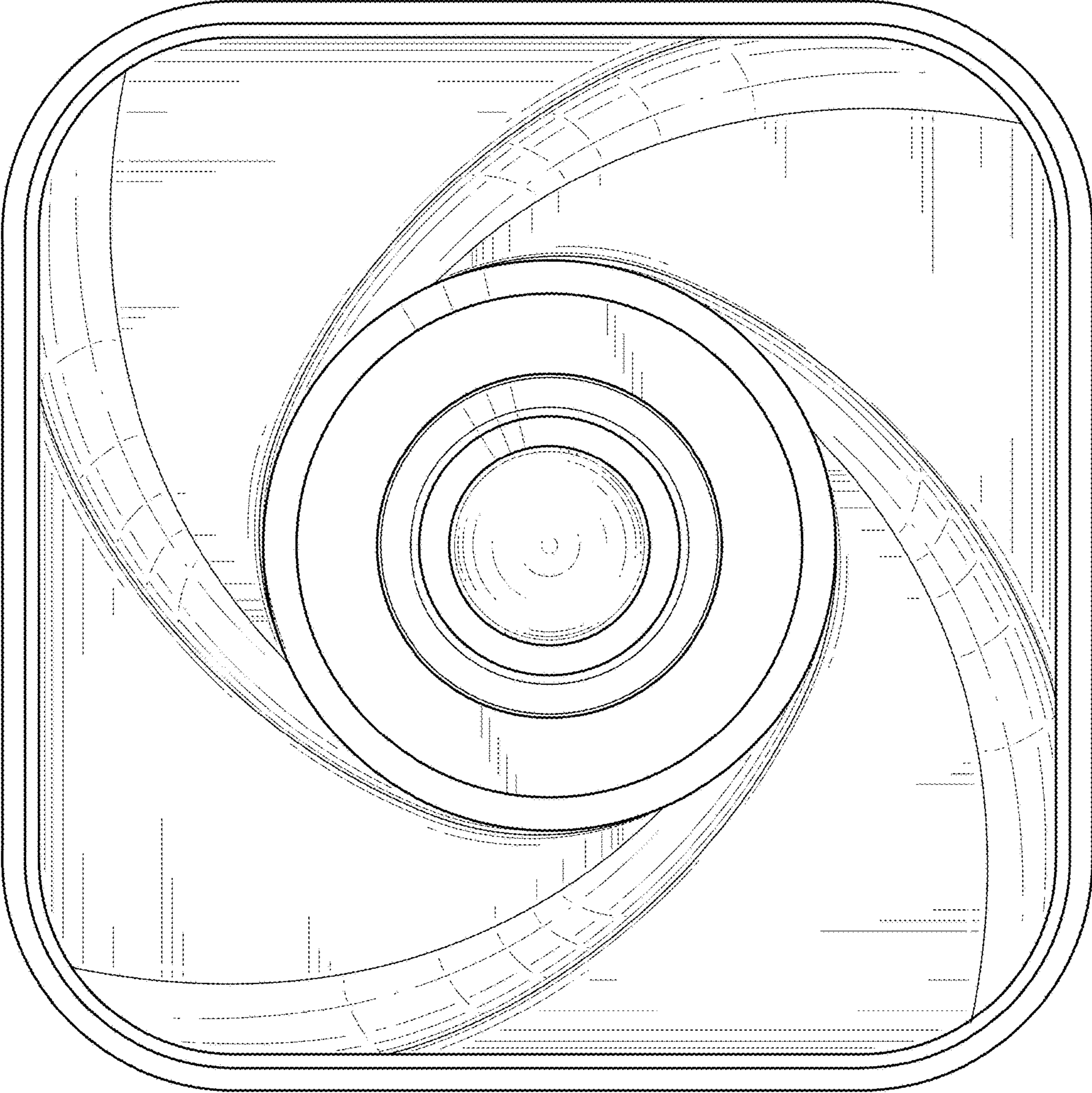

Fig. 3

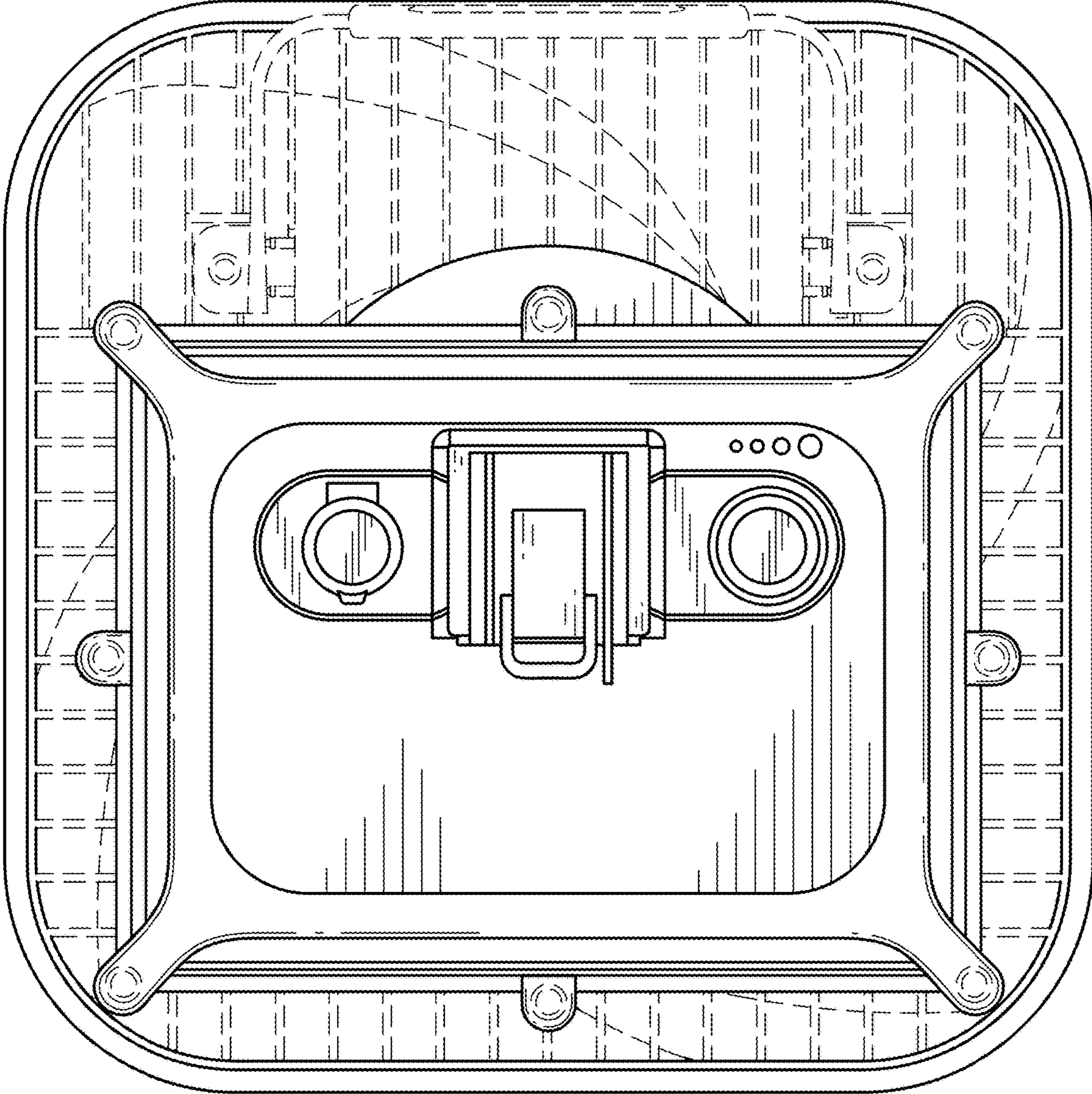

Fig. 4

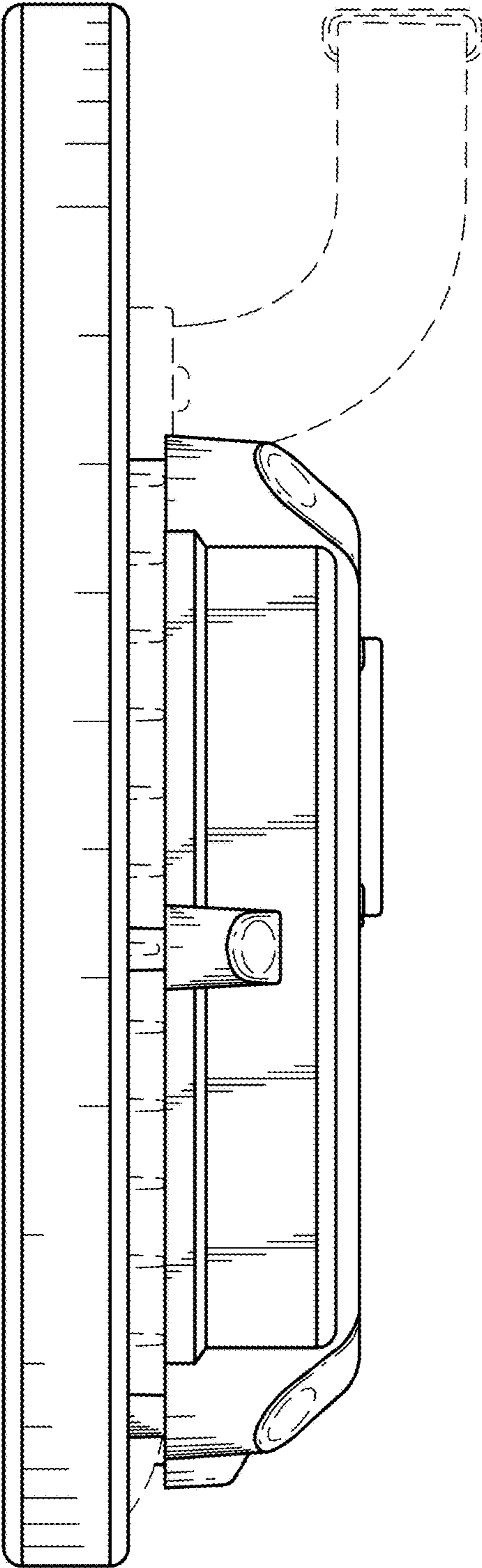

Fig. 5

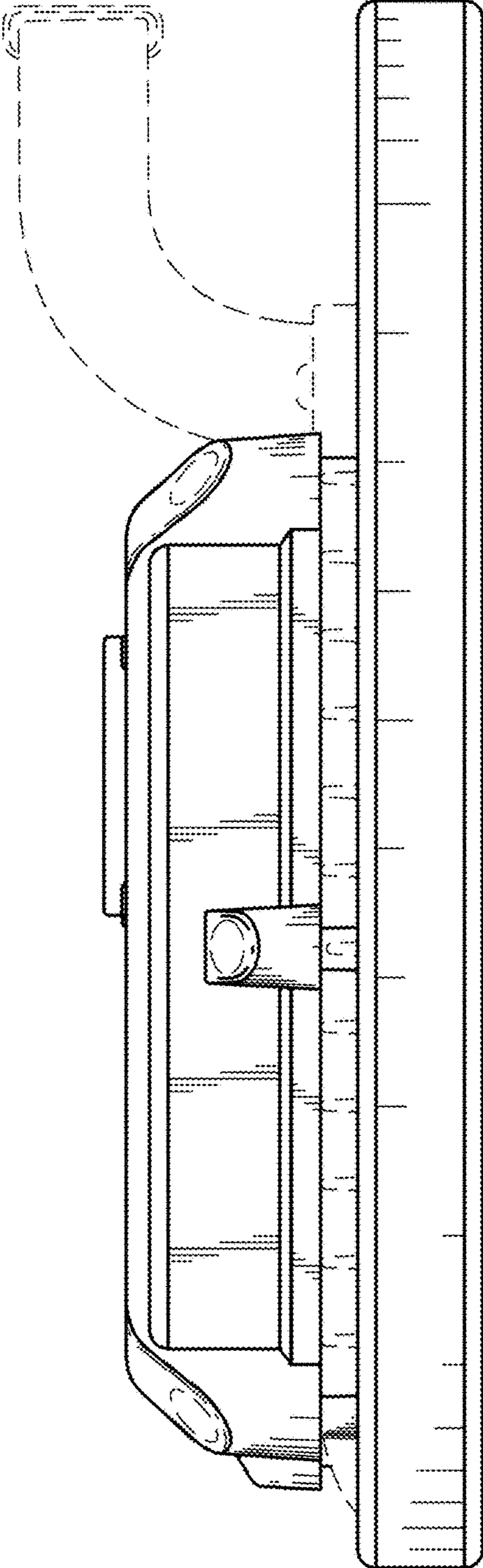

Fig. 6

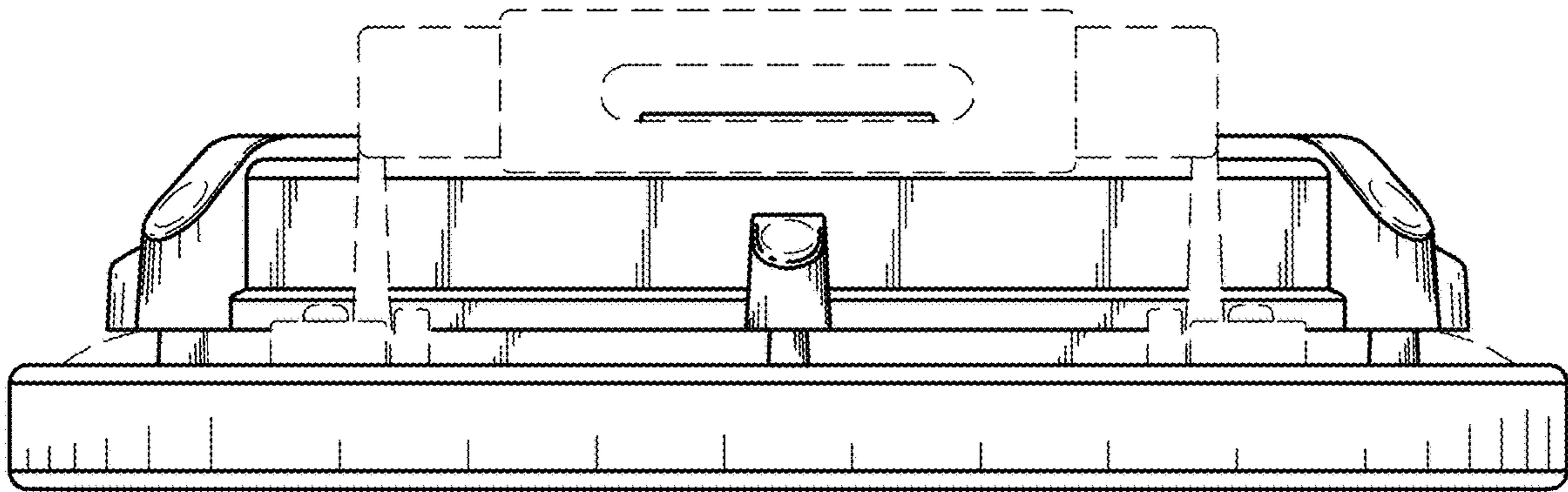

Fig. 7



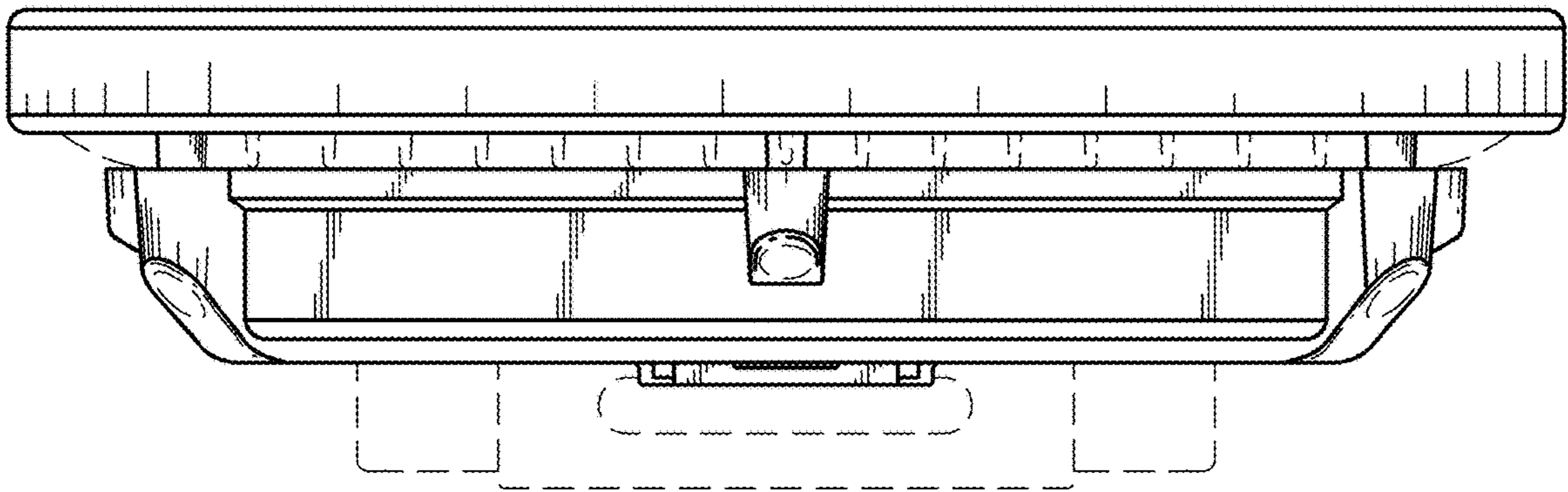

Fig. 8