



US00D839931S

(12) **United States Design Patent** (10) **Patent No.:** **US D839,931 S**
Choi et al. (45) **Date of Patent:** **** Feb. 5, 2019**

(54) **DRAWER FOR REFRIGERATOR**

(71) Applicant: **LG ELECTRONICS INC.**, Seoul (KR)

(72) Inventors: **Kyukwan Choi**, Seoul (KR); **Daesung Lee**, Seoul (KR); **Jihyun Lee**, Seoul (KR); **Hyunki Kim**, Seoul (KR)

(73) Assignee: **LG ELECTRONICS INC.**, Seoul (KR)

(**) Term: **15 Years**

(21) Appl. No.: **35/503,200**

(22) Filed: **Dec. 19, 2016**

(80) **Hague Agreement Data**
 Int. Filing Date: **Dec. 19, 2016**
 Int. Reg. No.: **DM/094058**
 Int. Reg. Date: **Dec. 19, 2016**
 Int. Reg. Pub. Date: **Jun. 23, 2017**

(30) **Foreign Application Priority Data**
 Jun. 28, 2016 (KR) 30-2016-0031491

(51) **LOC (11) Cl.** **15-07**

(52) **U.S. Cl.**
 USPC **D15/89**

(58) **Field of Classification Search**
 USPC D15/79-91
 (Continued)

(56) **References Cited**
 U.S. PATENT DOCUMENTS
 D513,270 S * 12/2005 Seok D15/89
 D656,968 S * 4/2012 Hwang D15/86
 (Continued)

Primary Examiner — Richard E Chilcot

(74) *Attorney, Agent, or Firm* — Birch, Stewart, Kolasch & Birch, LLP

(57) **CLAIM**
 The ornamental design for a drawer for refrigerator, as shown and described.

DESCRIPTION

1. Drawer for refrigerator

1.1 is a perspective view of a drawer for refrigerator, showing our new design;

1.2 is a front elevation view thereof;

1.3 is a rear elevation view thereof;

1.4 is a left-side elevation view thereof;

1.5 is a right-side elevation view thereof;

1.6 is a top plan view thereof;

1.7 is a bottom plan view thereof;

1.8 is a perspective view thereof, in a use condition;

1.9 is a perspective view of the drawer for refrigerator, when the lower drawer is slid out;

1.10 is a front elevation view thereof;

1.11 is a rear elevation view thereof;

1.12 is a left-side elevation view thereof;

1.13 is a right-side elevation view thereof;

1.14 is a top plan view thereof;

1.15 is a bottom plan view thereof;

1.16 is a perspective view thereof, in a use condition;

1.17 is a perspective view of the drawer for refrigerator, when the lower drawer is slid out and each of the baskets therein slides to each side;

1.18 is a front elevation view thereof;

1.19 is a rear elevation view thereof;

1.20 is a left-side elevation view thereof;

1.21 is a right-side elevation view thereof;

1.22 is a top plan view thereof;

1.23 is a bottom plan view thereof;

1.24 is a perspective view thereof, in a use condition;

1.25 is a perspective view of the drawer for refrigerator, when each of the upper and lower drawers is slid out and each of the baskets therein slides to each side;

1.26 is a front elevation view thereof;

1.27 is a rear elevation view thereof;

1.28 is a left-side elevation view thereof;

(Continued)

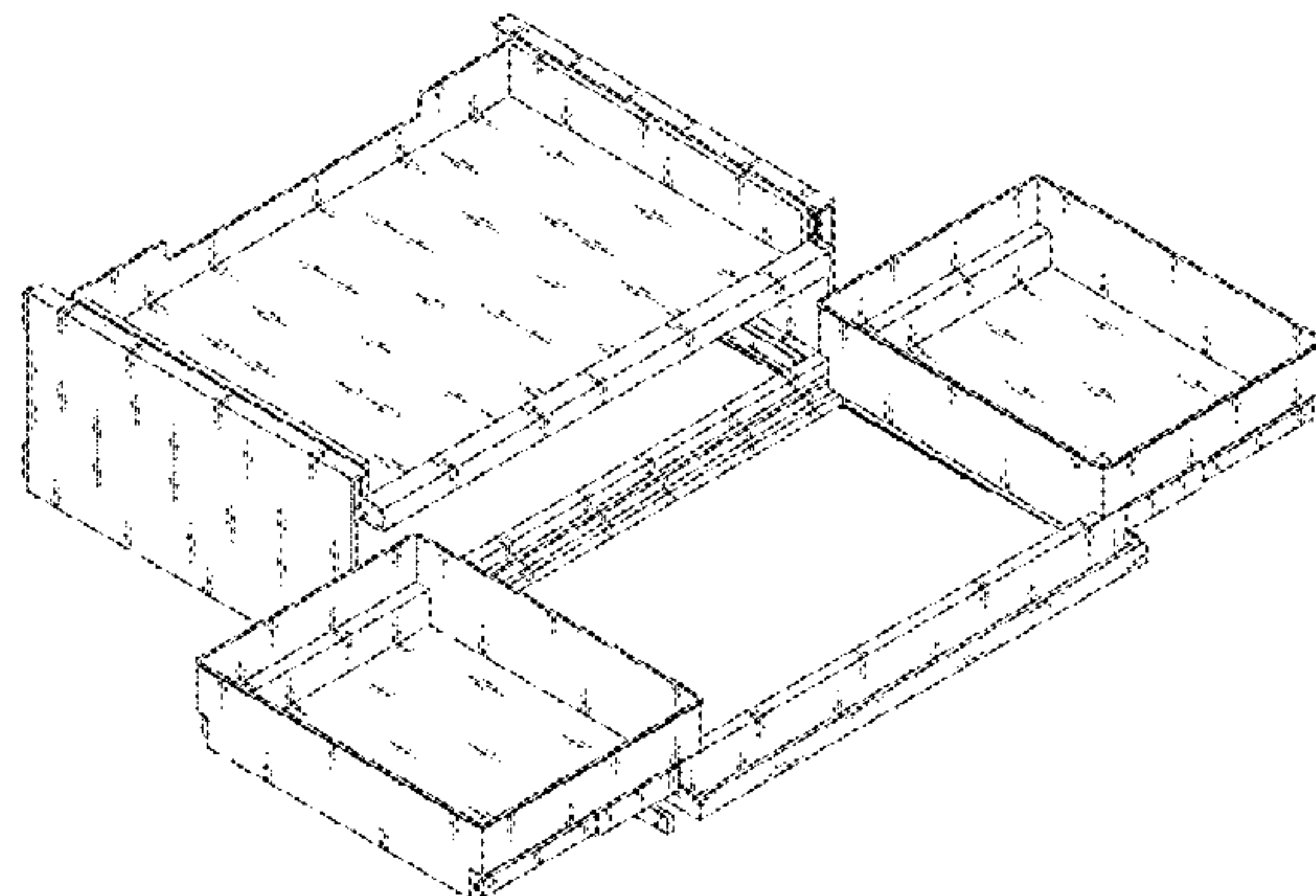

1.29 is a right-side elevation view thereof;
1.30 is a top plan view thereof;
1.31 is a bottom plan view thereof; and
1.32 is a perspective view thereof, in a use condition.
The broken lines shown in the drawing figures are included for the purpose of illustrating environment and form no part of the claimed design.

1 Claim, 32 Drawing Sheets

- (52) **U.S. Cl.**
CPC *F25D 25/02* (2013.01)
- (58) **Field of Classification Search**
CPC F25D 25/02; F25D 25/024; F25D 23/00;
F25D 2325/022; F25D 25/04; F25D
23/067; F25D 23/04; F25D 11/00; F25D
23/025; F25D 25/025; F25D 27/00; F25D
2325/021; F25D 2400/22; F25D 11/02;
F25D 23/12; F25D 27/005; F25D
2331/80; F25D 2323/122; F25D 2325/00;
F25D 2327/00; F25D 2327/001; F25D
2331/809; F25D 2331/81; F25D 23/062;
F25D 23/065; F25D 23/069; F25D
23/087; F25D 23/126; F25D 2400/36;
F25D 2400/361; F25D 25/00; F25D
2600/00; F25D 2600/02; F25D 17/042;

F25D 2331/805; F25D 23/028; F25D
2400/40; F25D 2500/02; F25D 2500/06;
F25D 25/022; F25D 25/028; F25D
2201/00; F25D 2317/041; F25D
2317/0411; F25D 2317/0416

See application file for complete search history.

(56)

References Cited

U.S. PATENT DOCUMENTS

D658,213	S	*	4/2012	Seo	D15/86
D658,214	S	*	4/2012	Seo	D15/86
D671,152	S	*	11/2012	Seo	D15/89
D676,468	S	*	2/2013	Lee	D15/89
D677,289	S	*	3/2013	Seo	D15/90
D685,010	S	*	6/2013	Seo	D15/86
D706,314	S	*	6/2014	Seo	D15/89
D718,349	S	*	11/2014	Cho	D15/85
D730,954	S	*	6/2015	Choi	D15/89
D730,957	S	*	6/2015	You	D15/91
D731,562	S	*	6/2015	You	D15/89
D737,869	S	*	9/2015	Seo	D15/91
D743,454	S	*	11/2015	Yeo	D15/89
D774,114	S	*	12/2016	Lee	D15/89
D786,949	S	*	5/2017	Onrat	D15/89
D798,509	S	*	9/2017	Fuller	D32/3
D802,631	S	*	11/2017	Seo	D15/90
D815,695	S	*	4/2018	Waldman	D21/328

* cited by examiner

1.1

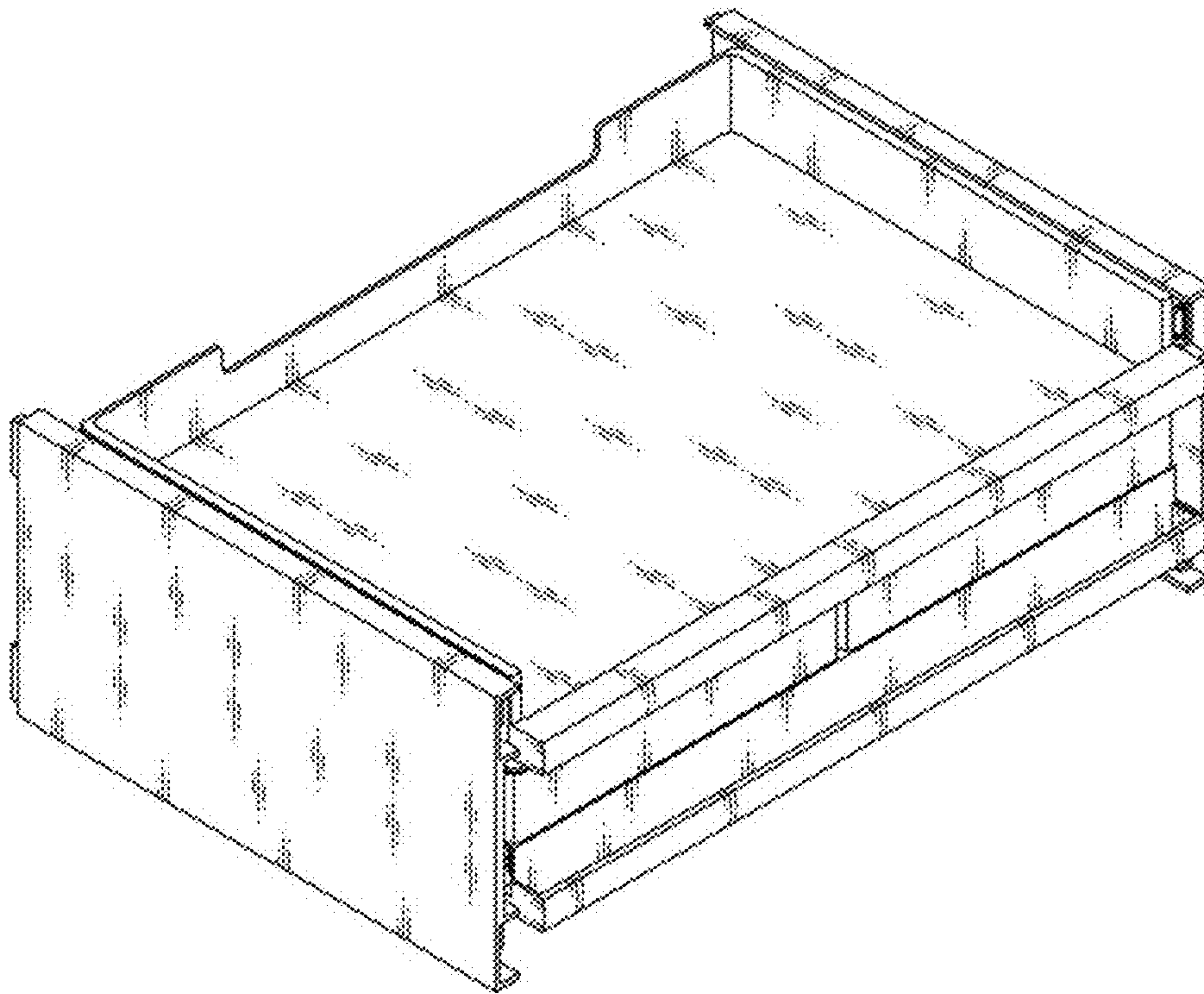

1.2

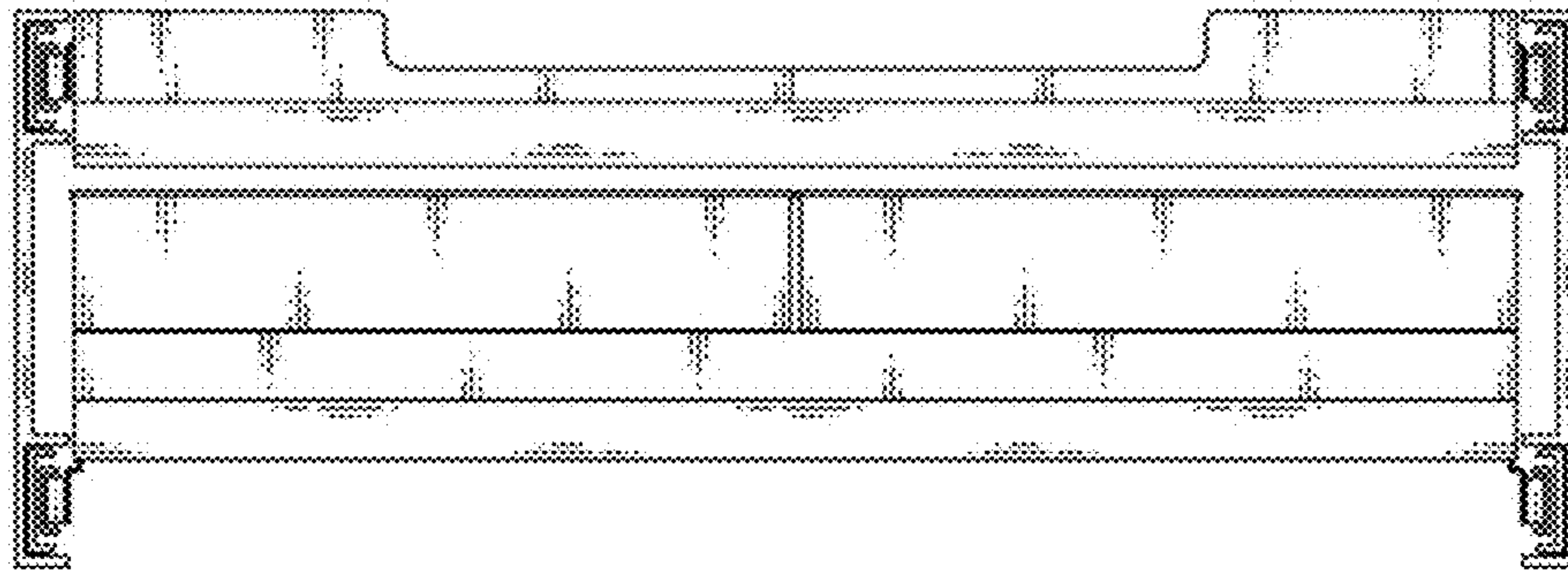

1.3

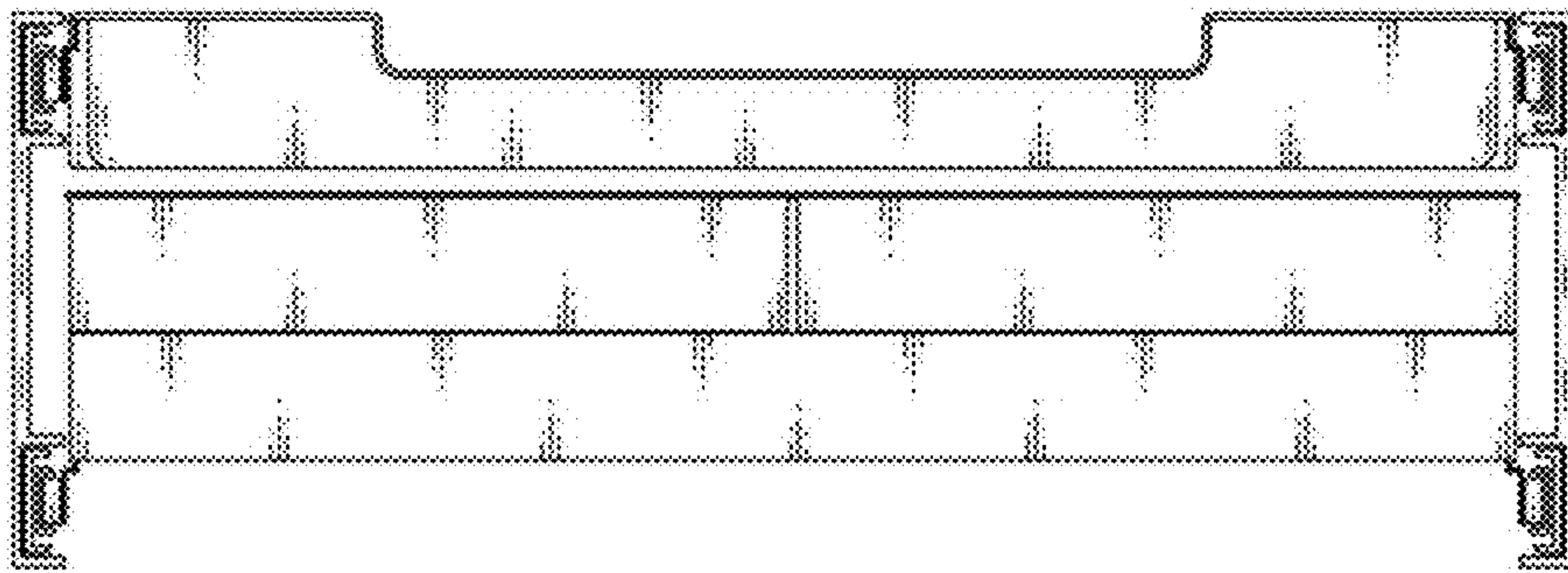

1.4

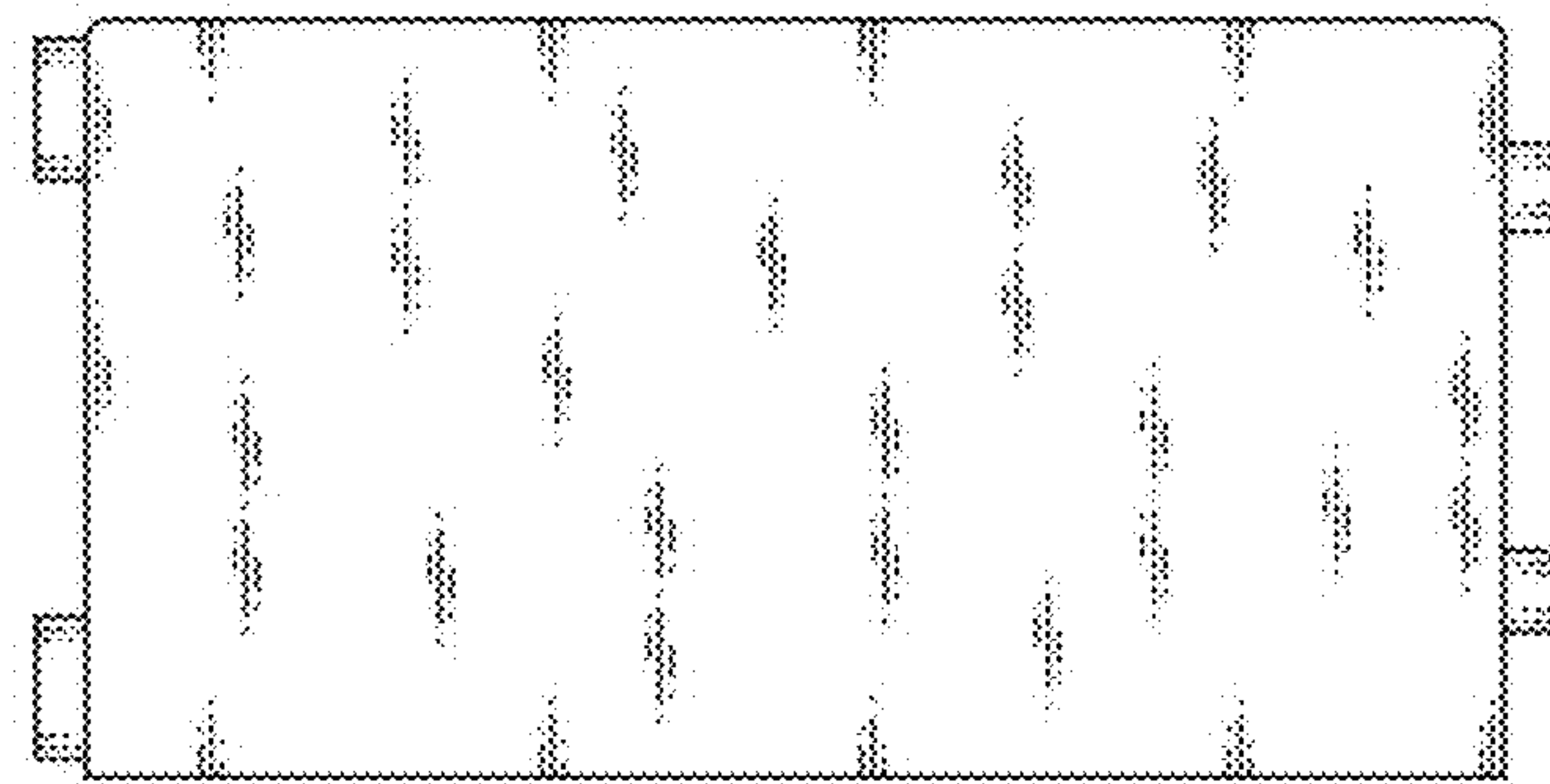

1.5

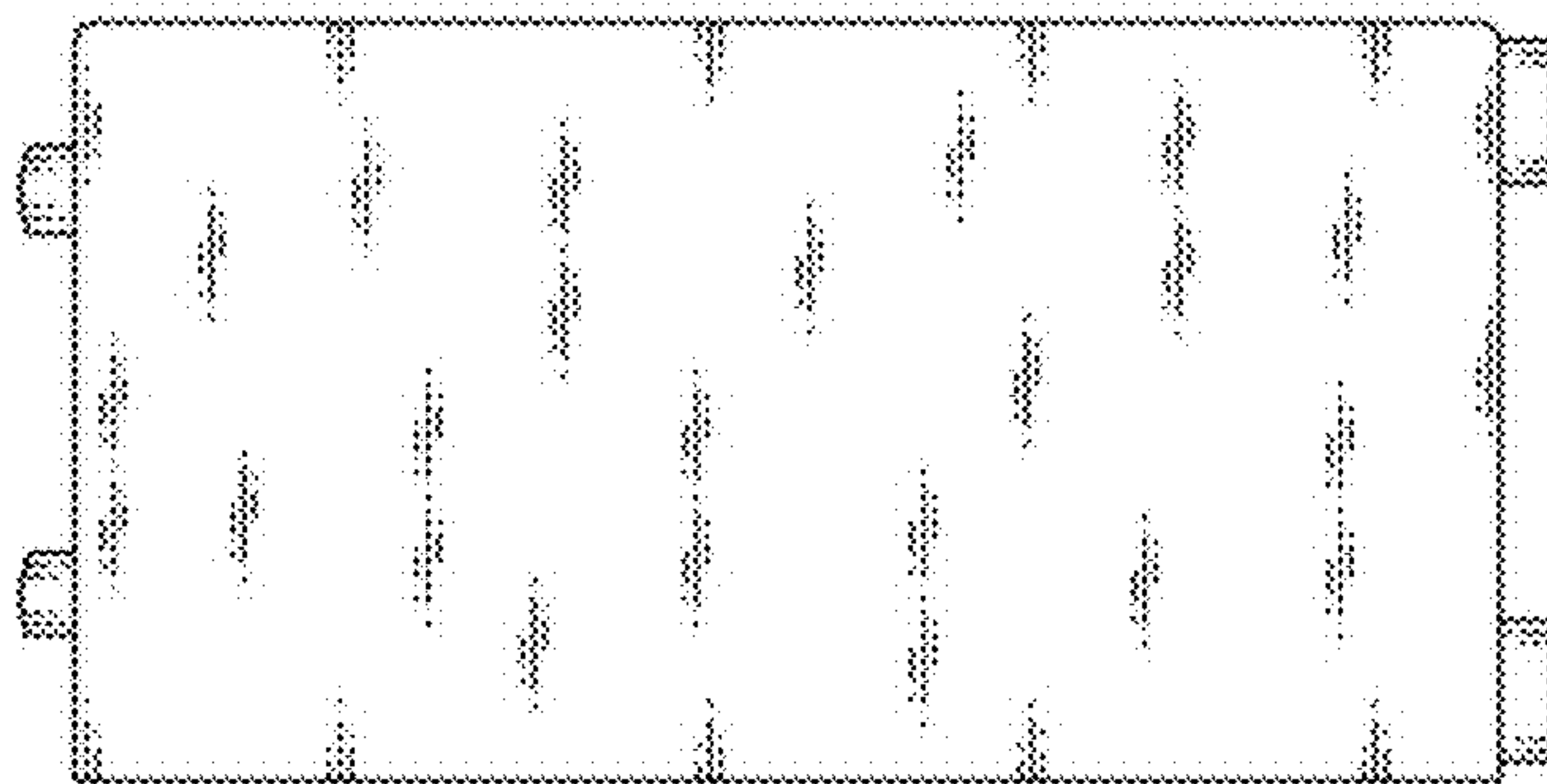

1.6

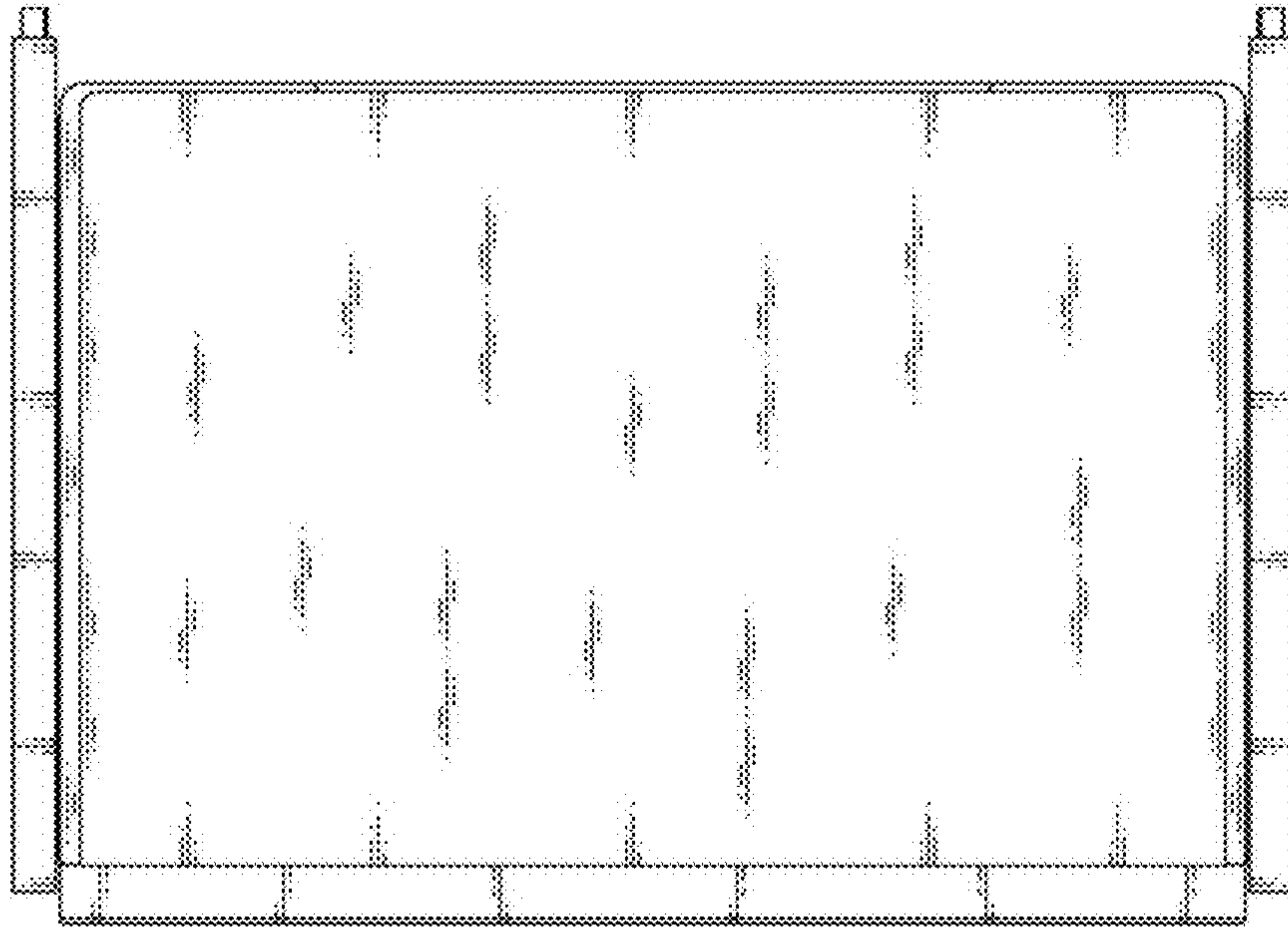

1.7

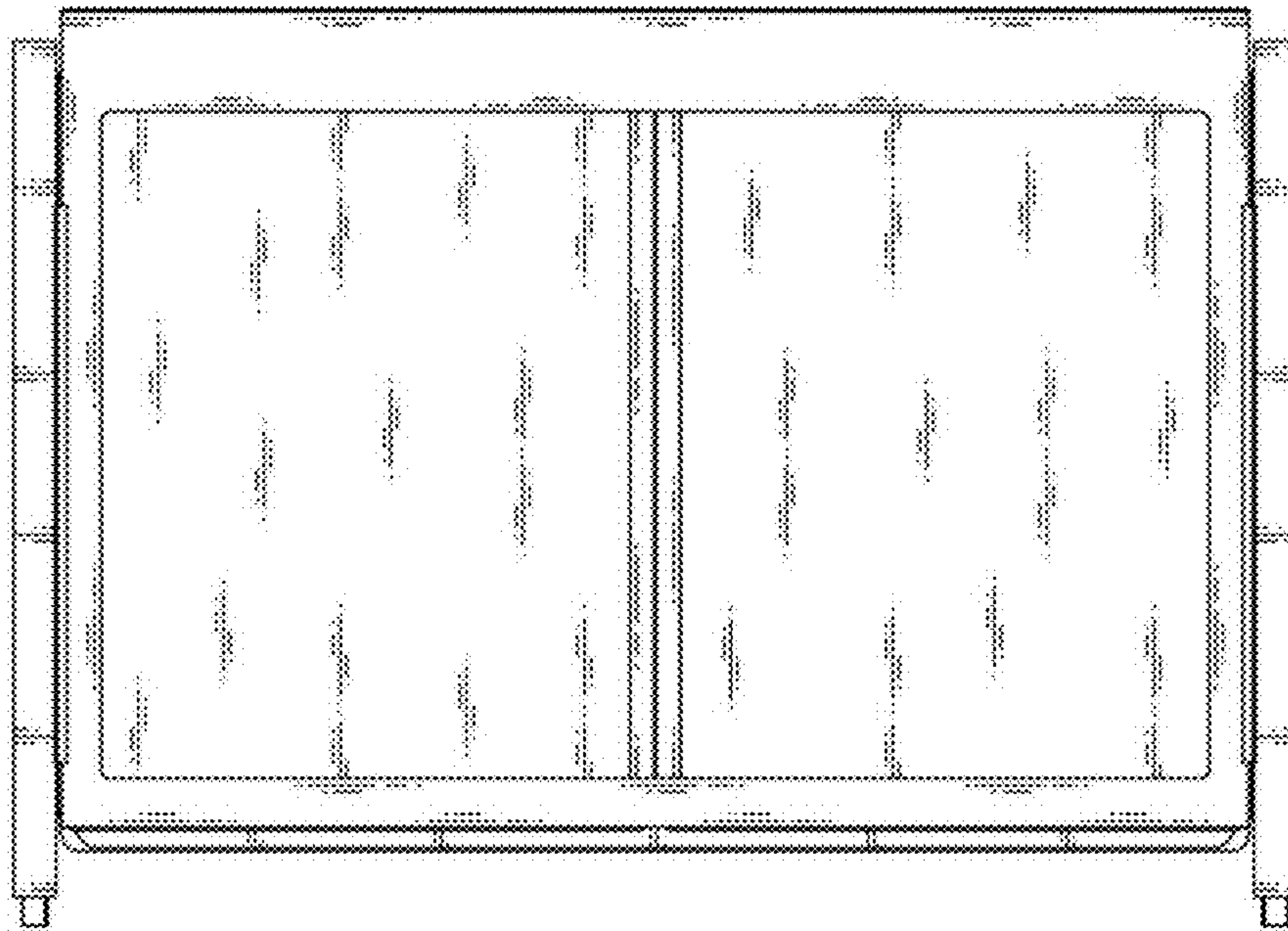

1.8

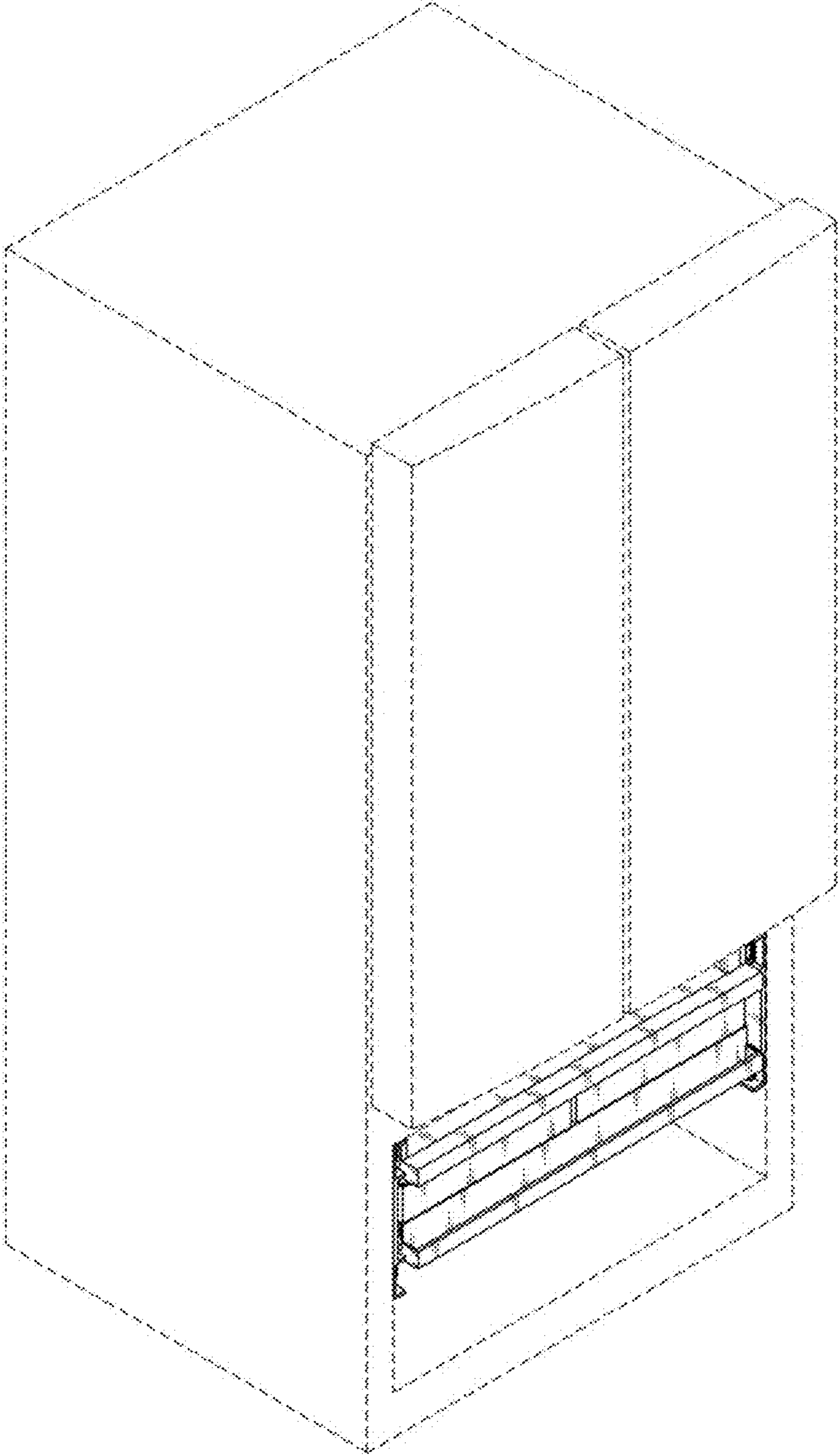

1.9

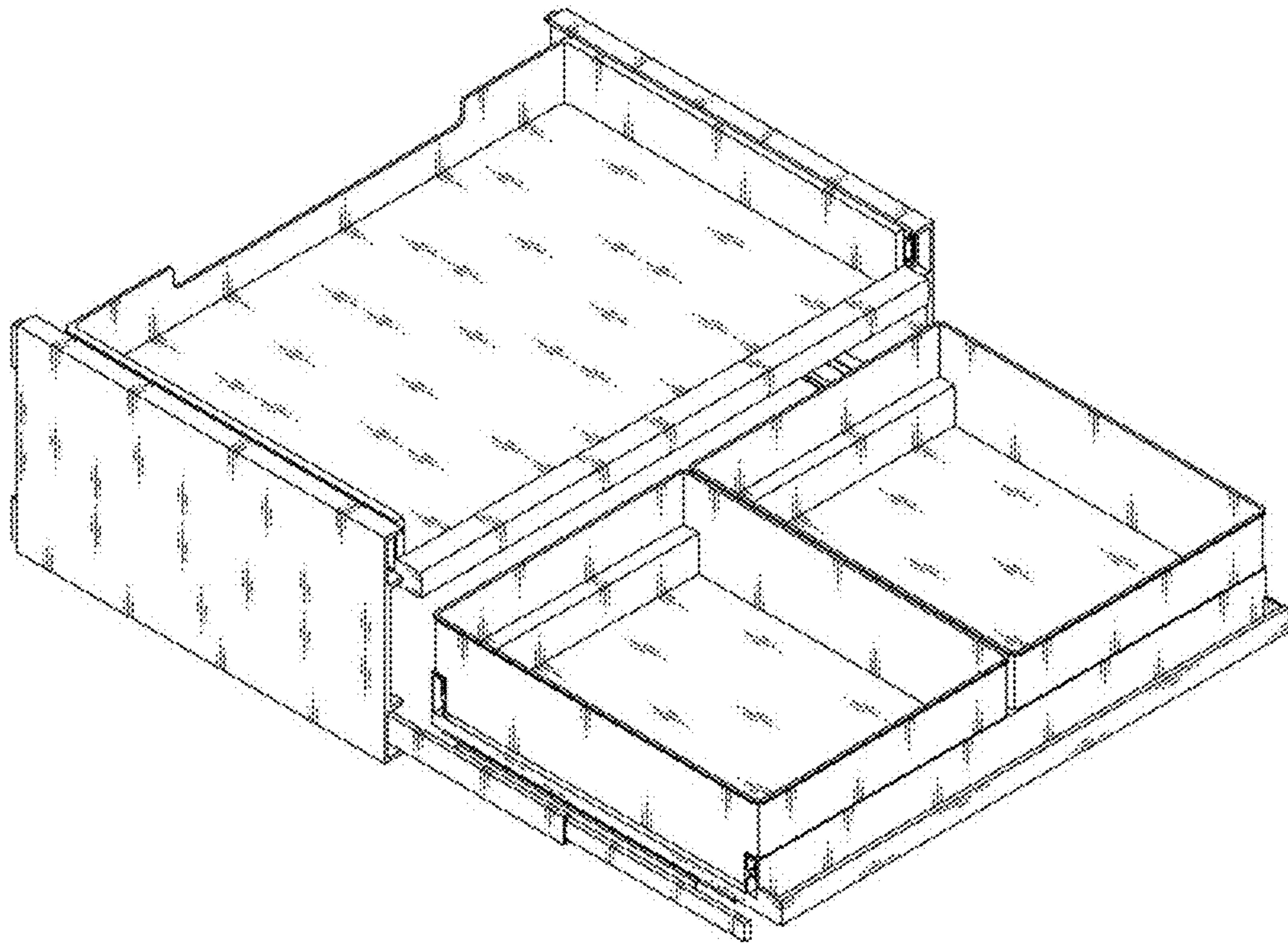

1.10

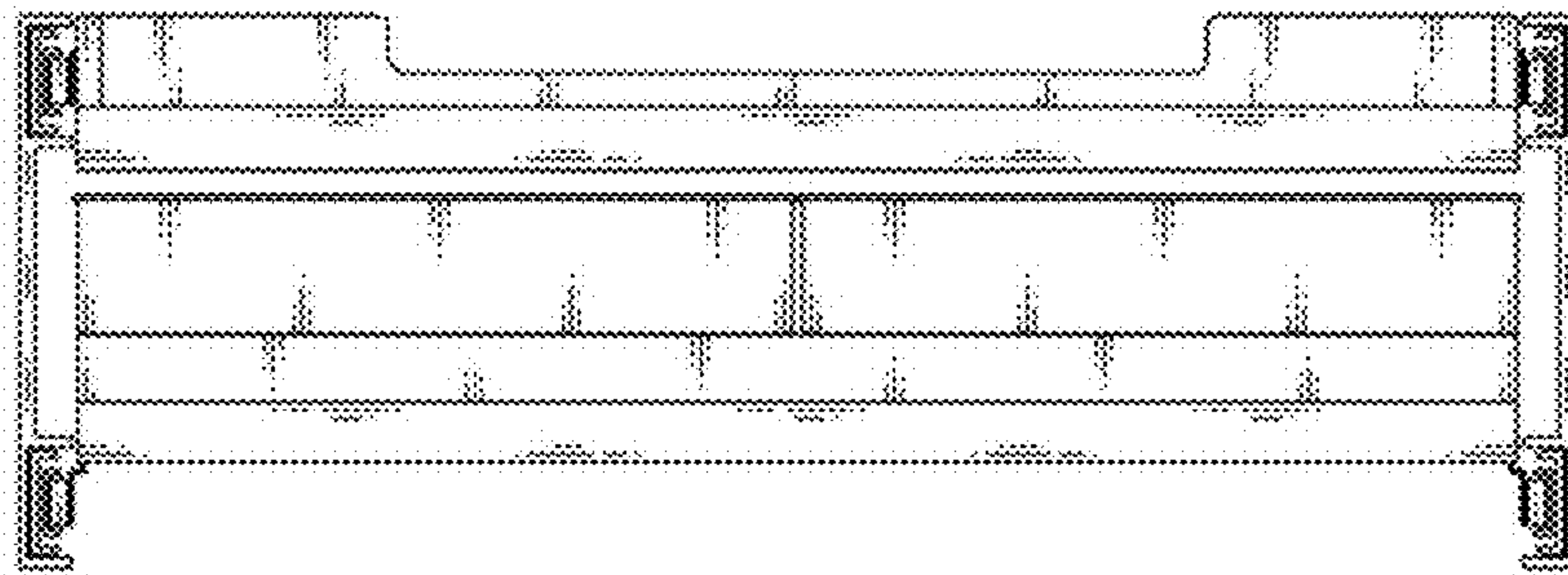

1.11

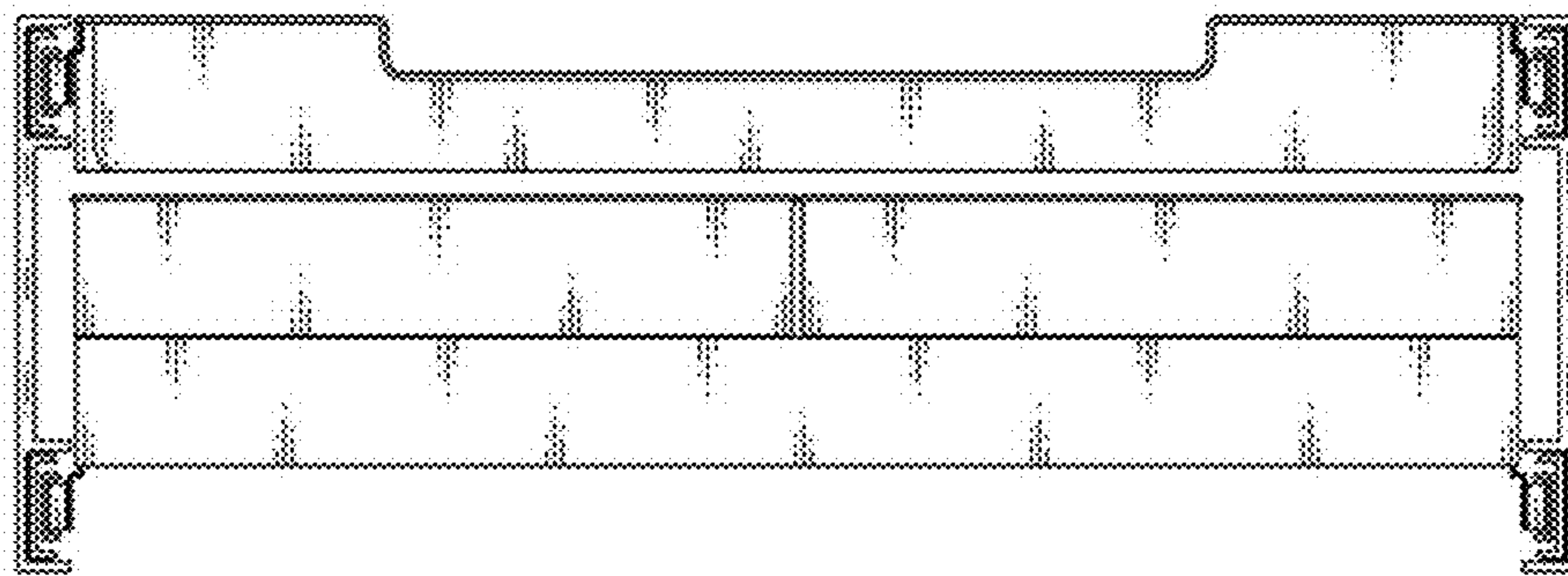

1.12

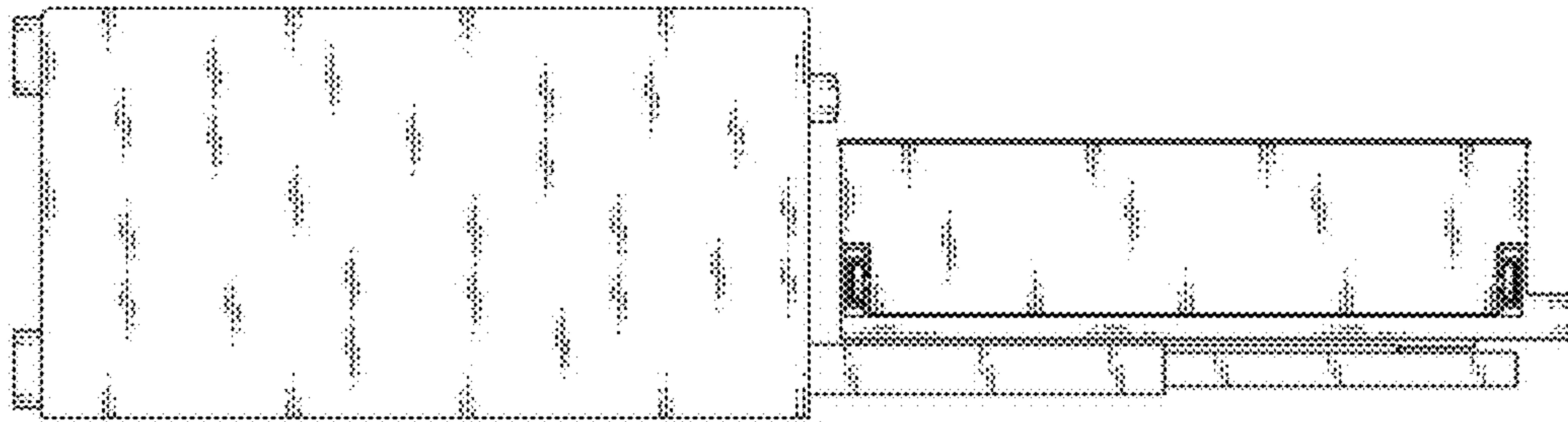

1.13

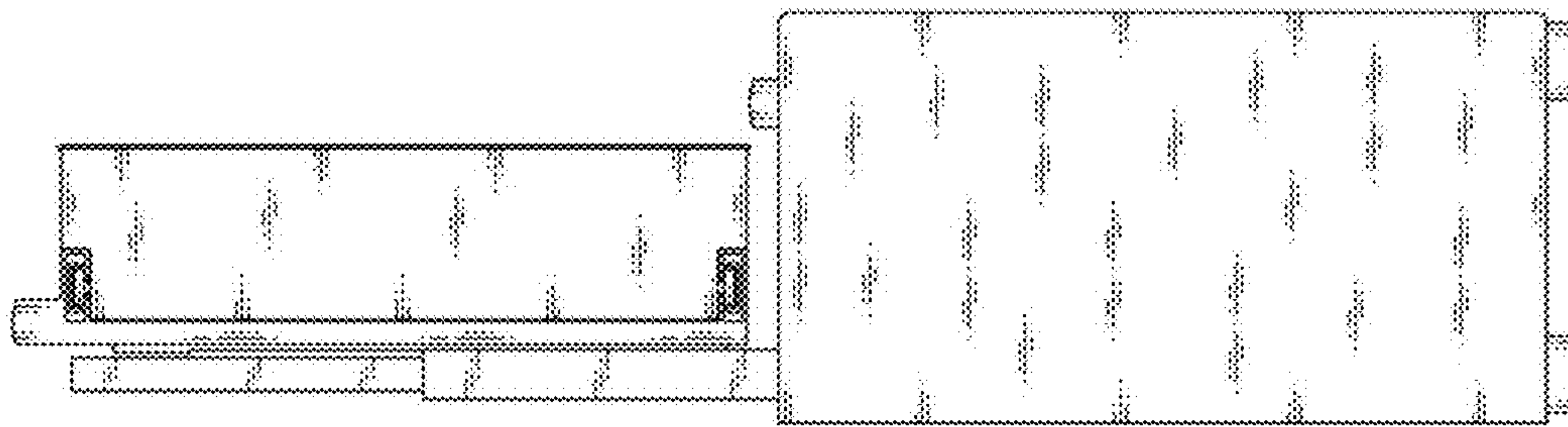

1.14

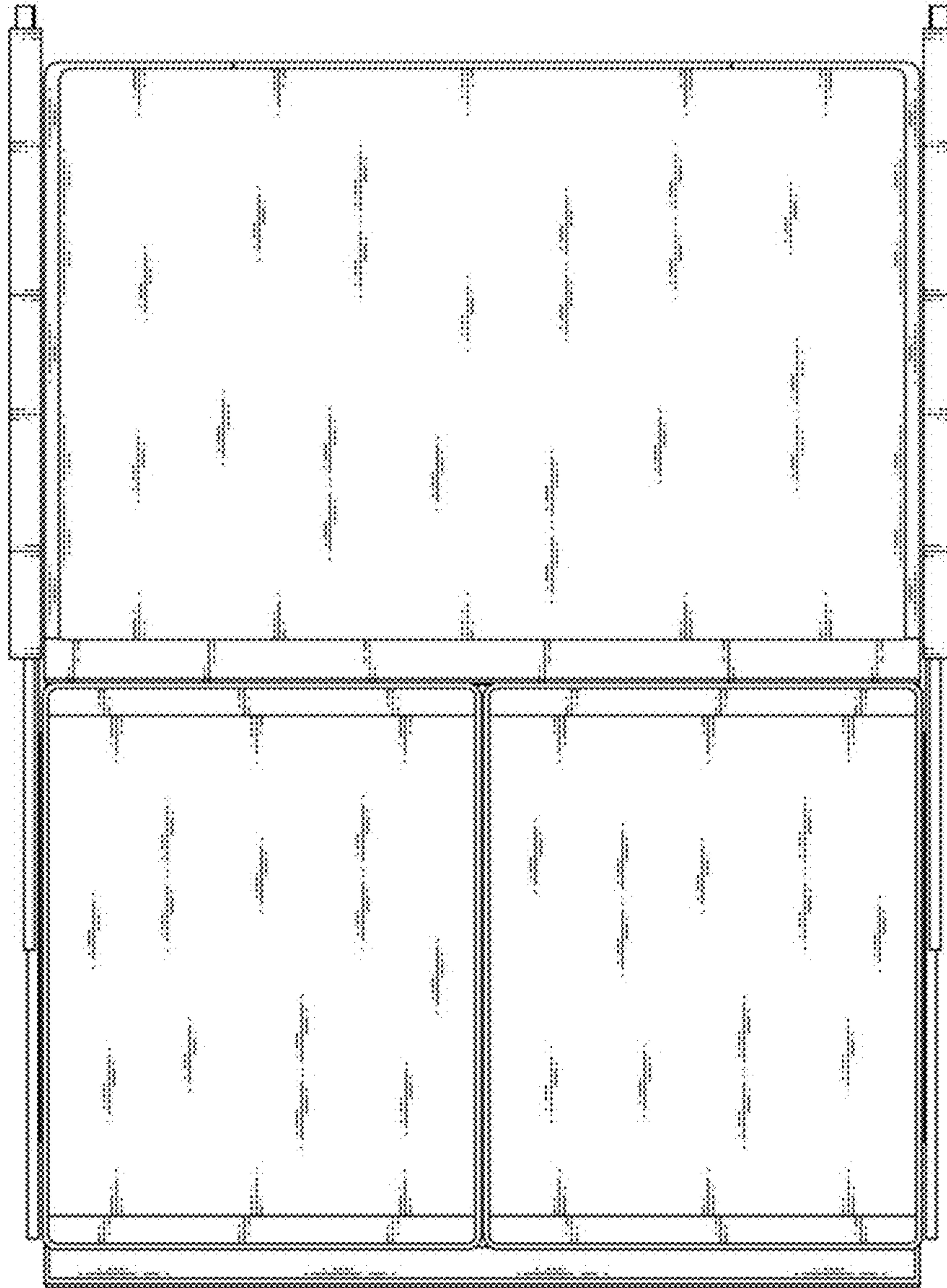

1.15

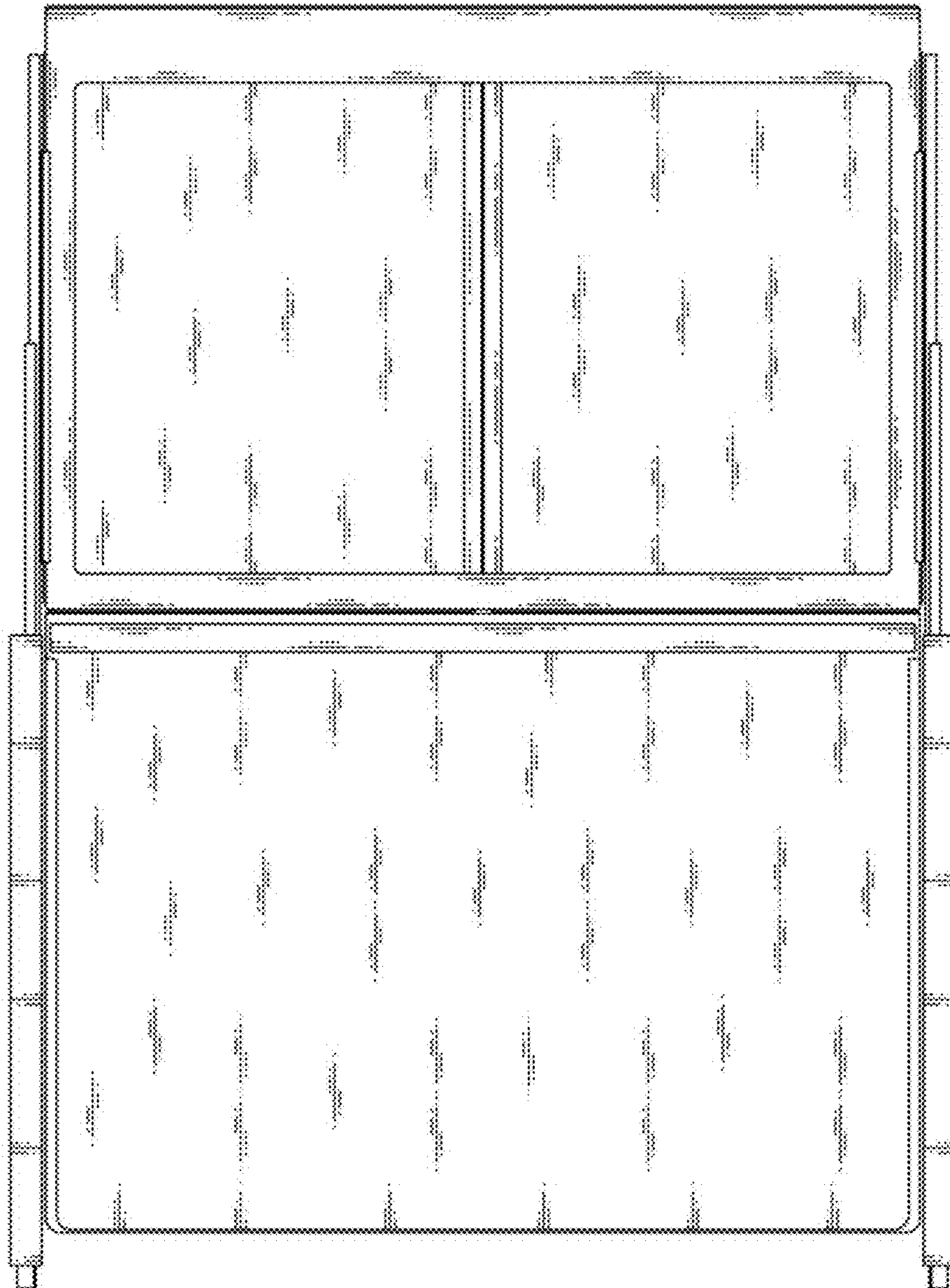

1.16

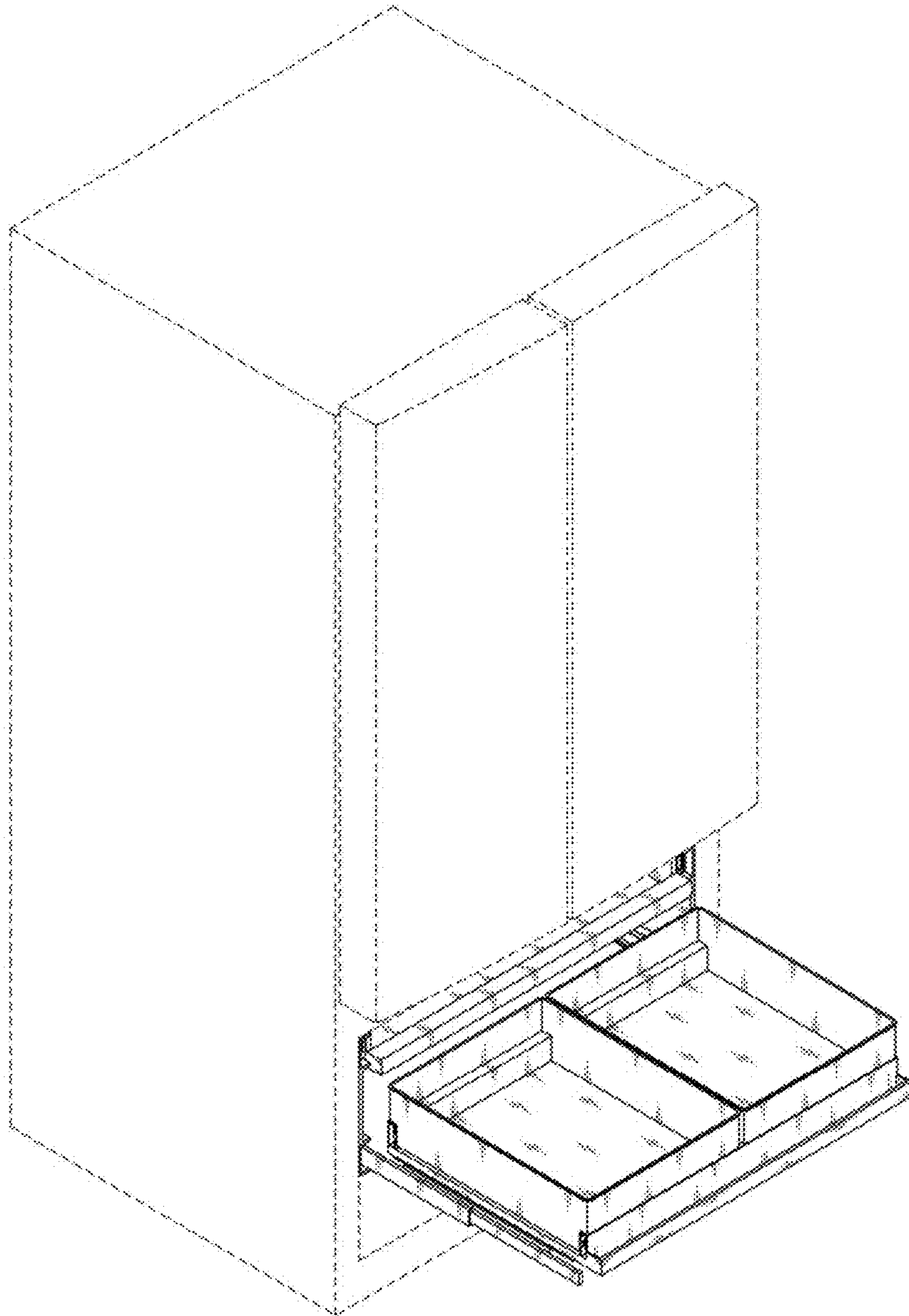

1.17

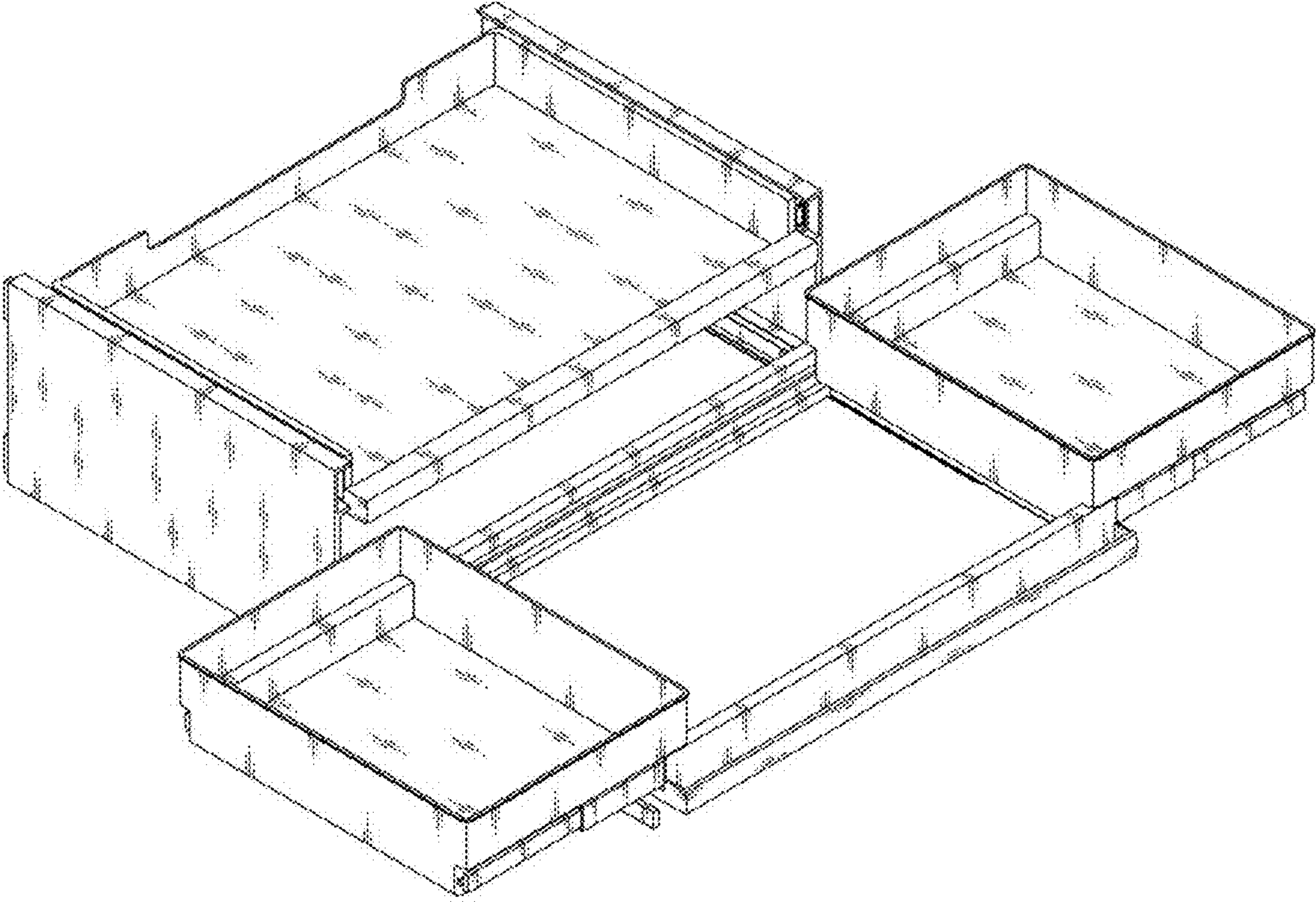

1.18

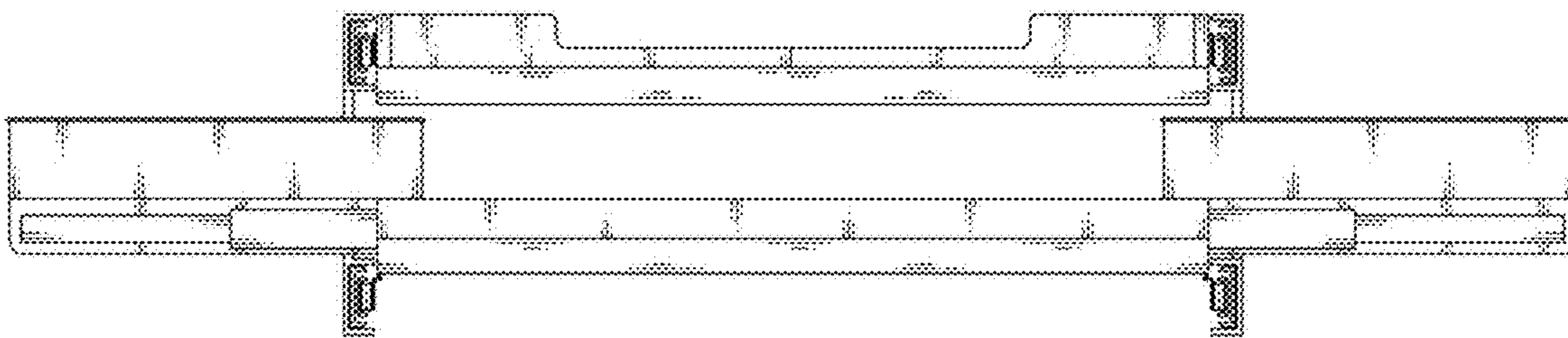

1.19

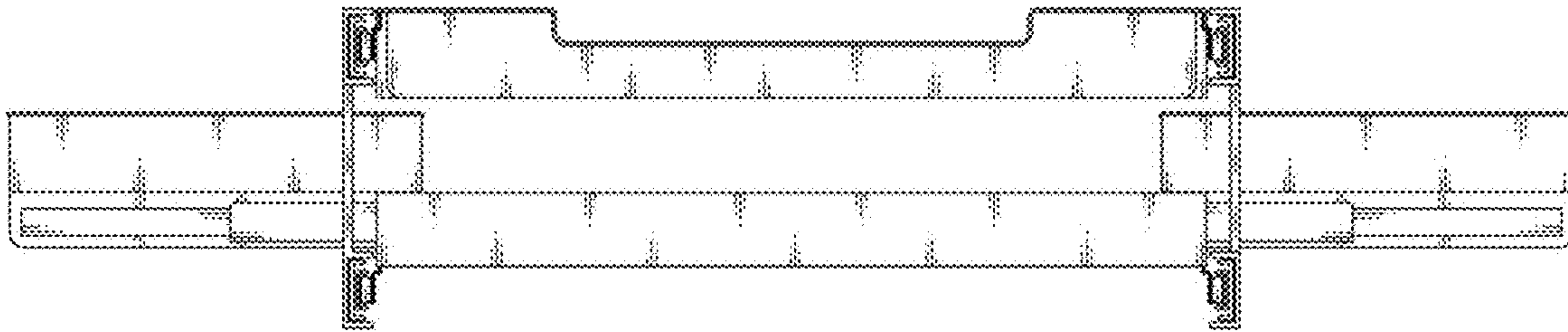

1.20

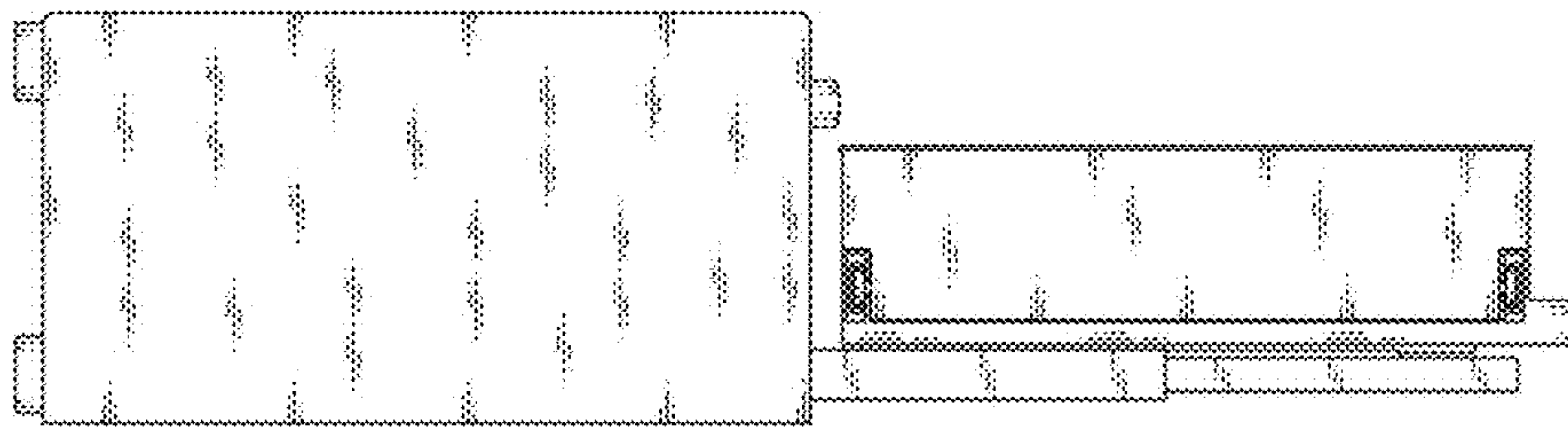

1.21

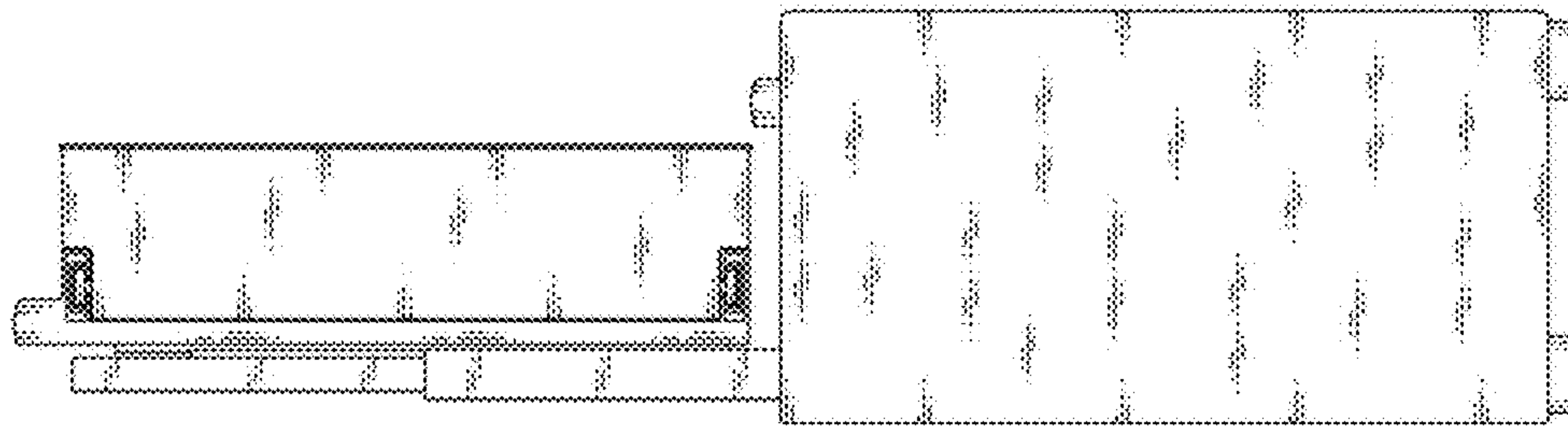

1.22

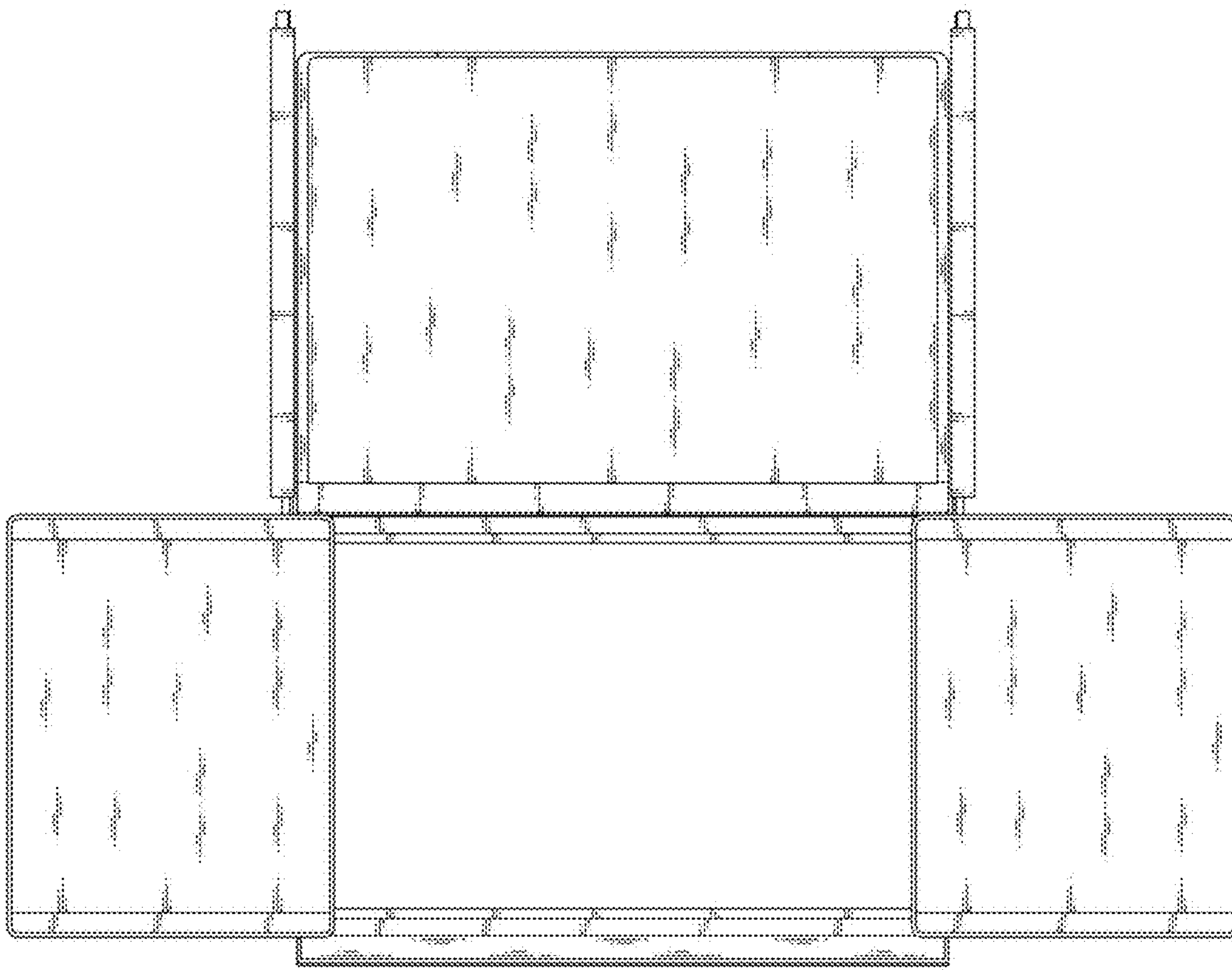

1.23

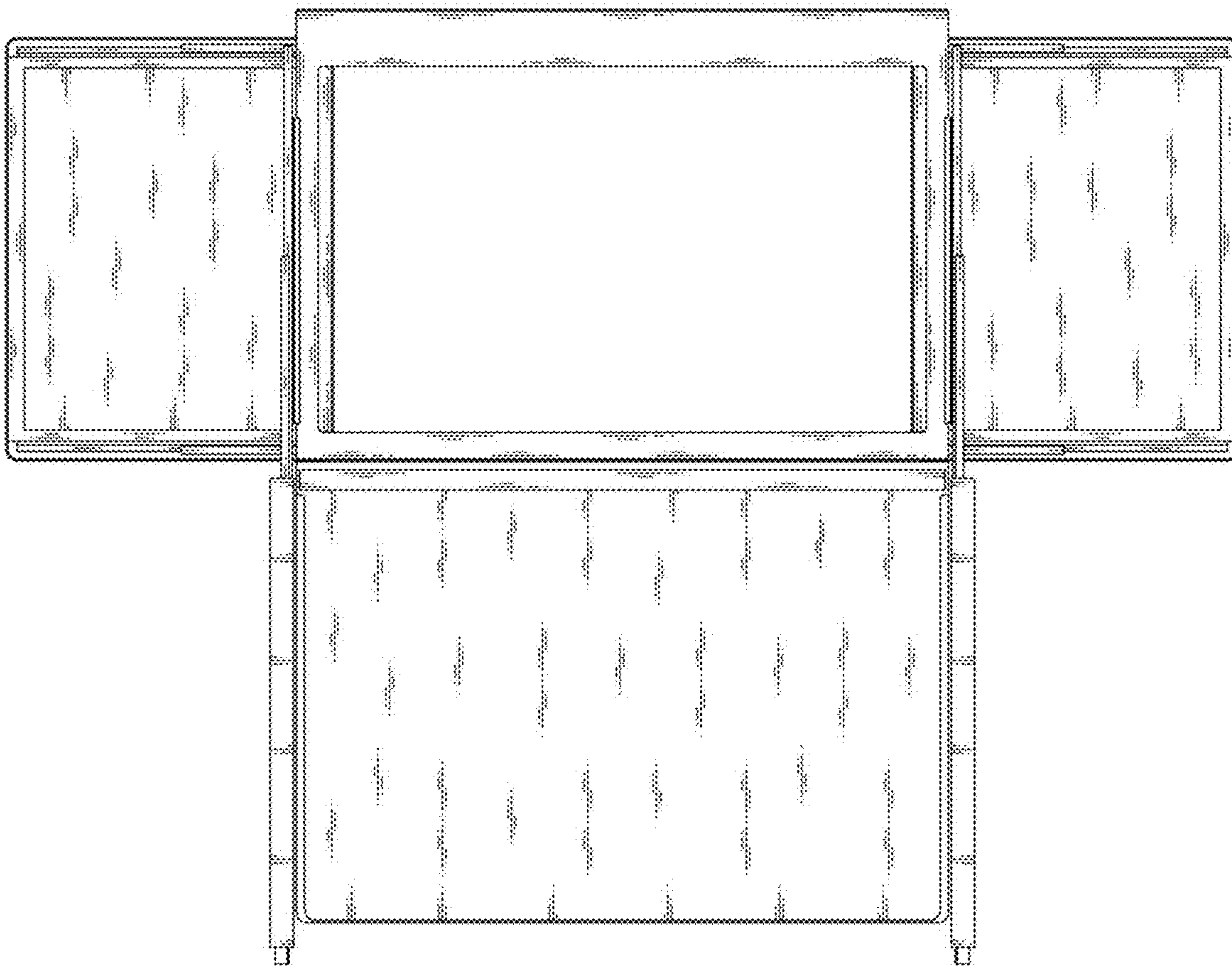

1.24

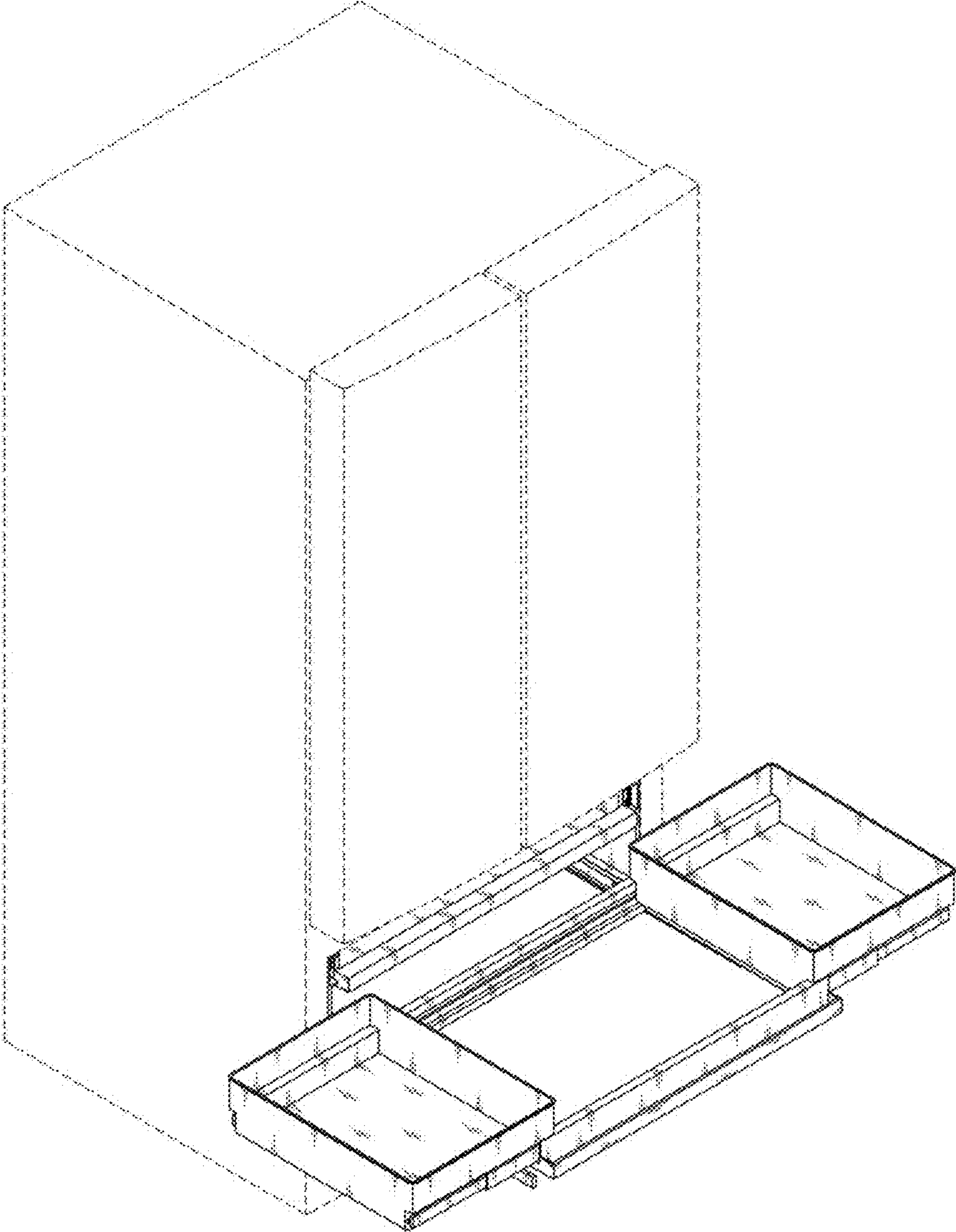

1.25

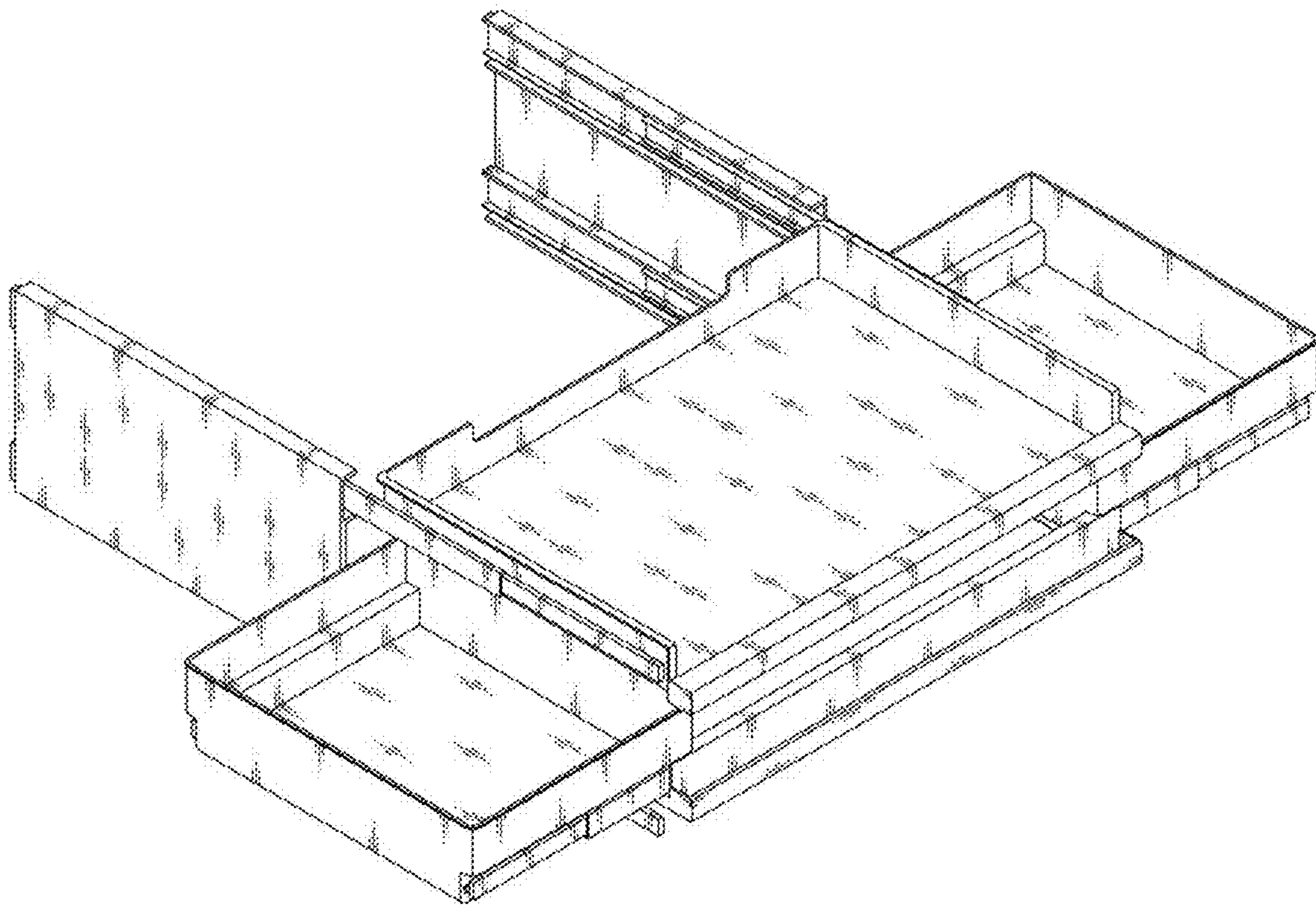

1.26

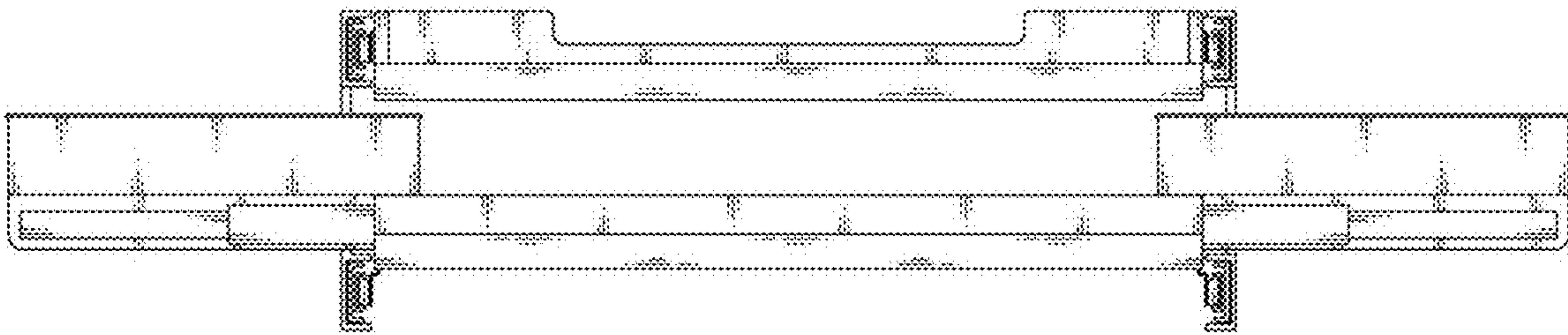

1.27

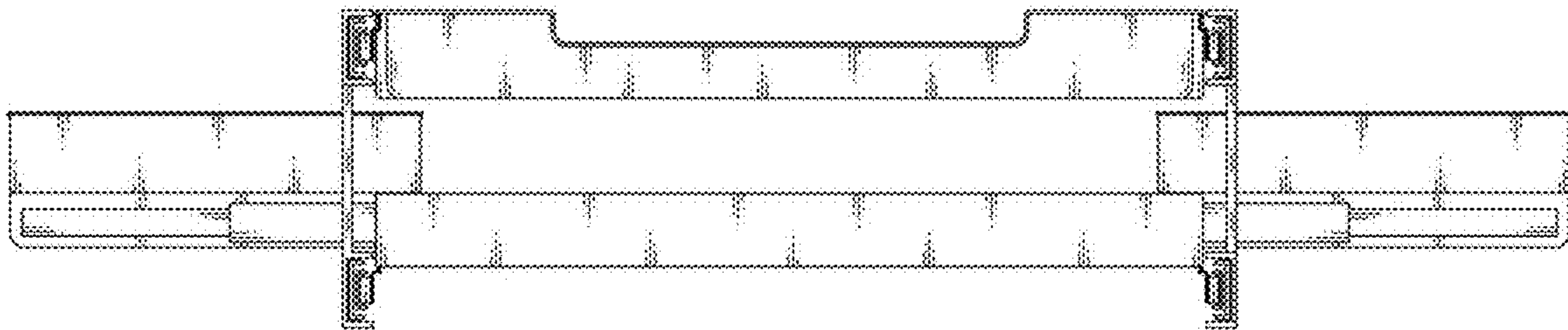

1.28

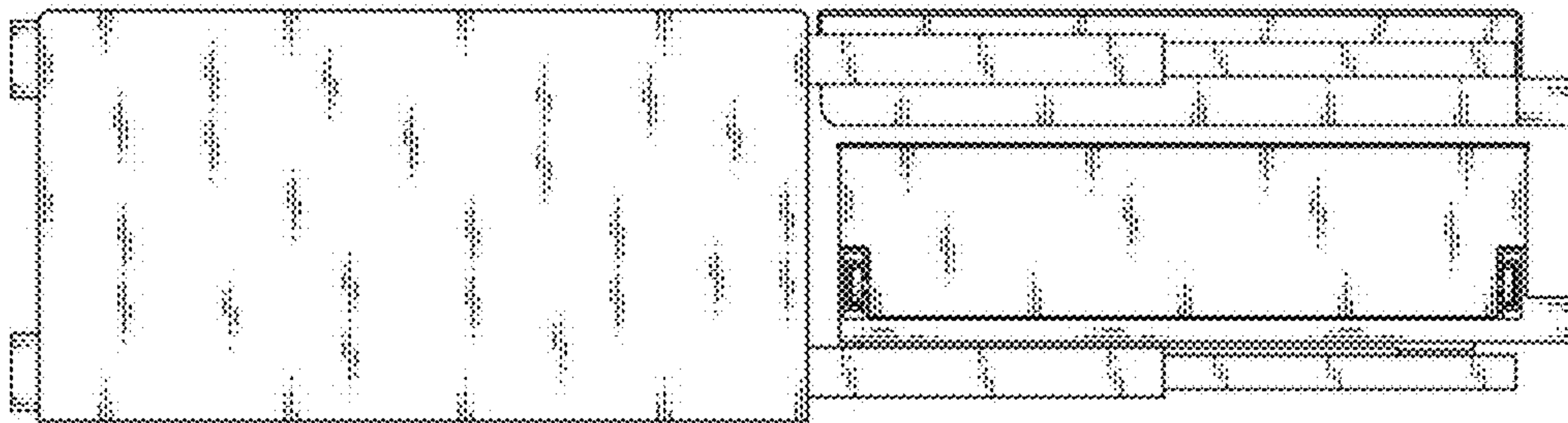

1.29

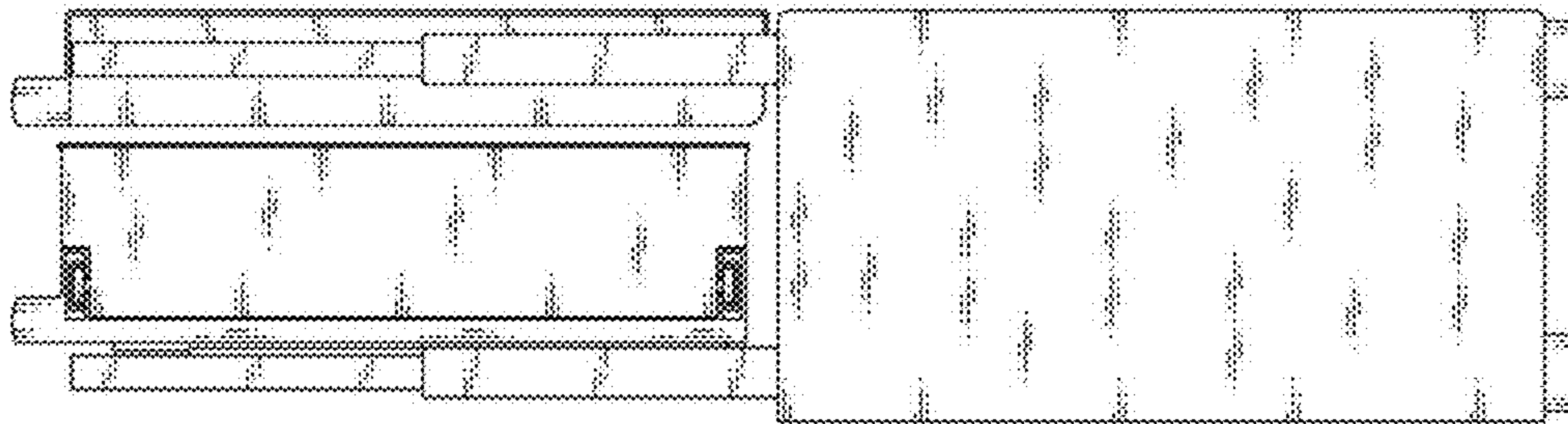

1.30

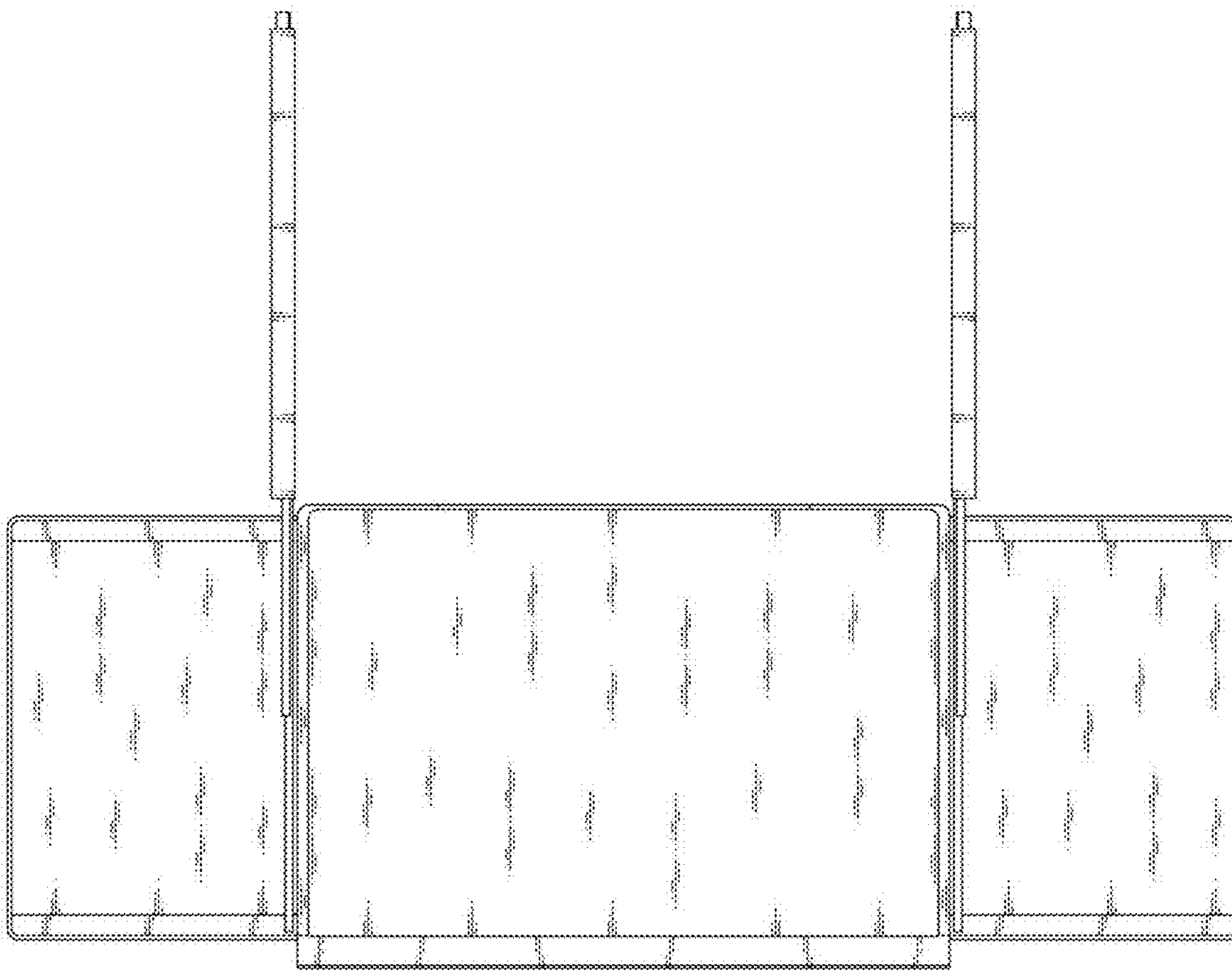

1.31

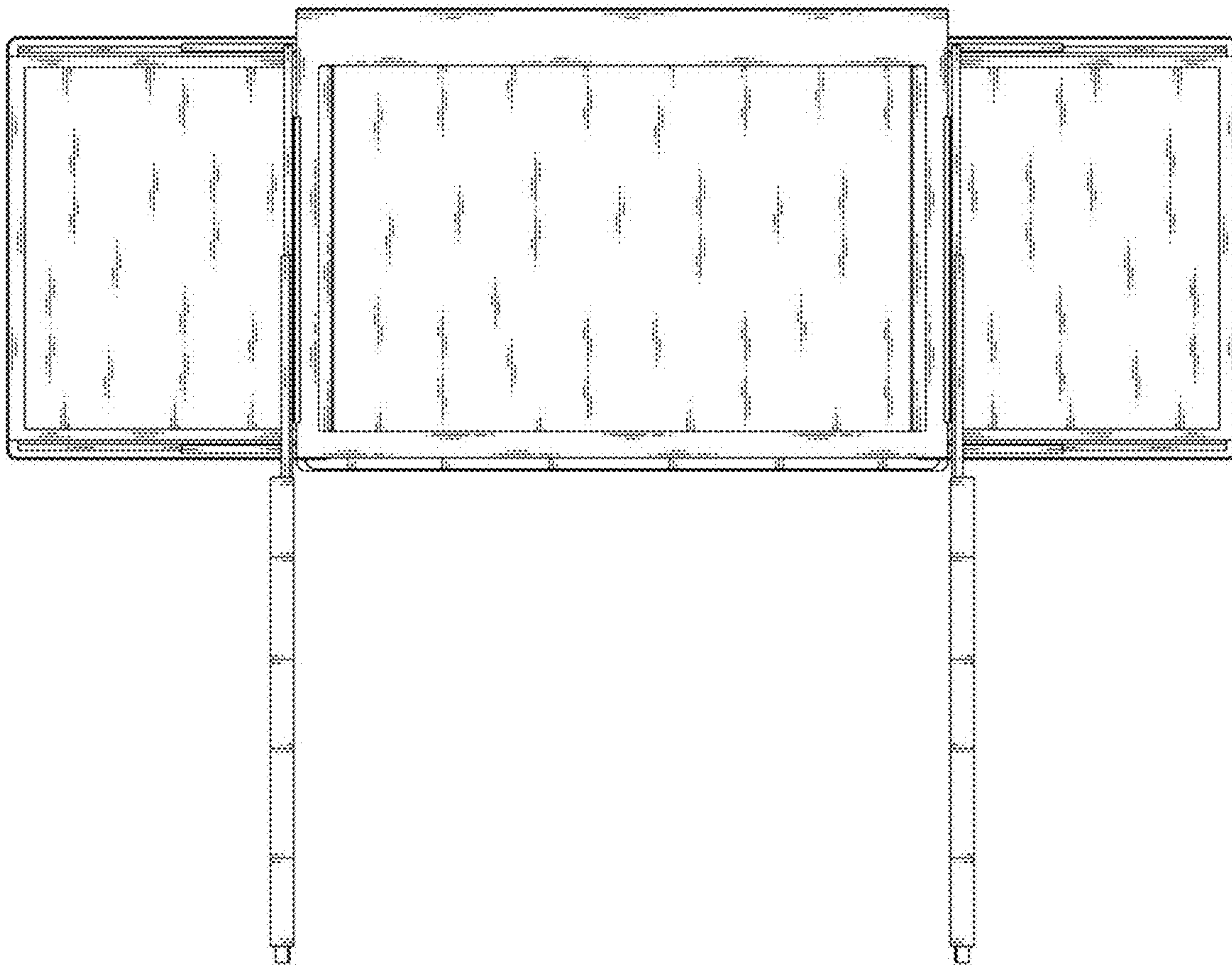

1.32

