



US00D839845S

(12) **United States Design Patent**
Yan et al.

(10) **Patent No.:** **US D839,845 S**
(45) **Date of Patent:** **** Feb. 5, 2019**

(54) **INDUSTRIAL ROBOT CONTROLLER**

(71) Applicant: **ABB Schweiz AG**, Baden (CH)

(72) Inventors: **Wenzhou Yan**, Shanghai (CN); **Jingwei Liu**, Shanghai (CN); **Chunping Zhang**, Shanghai (CN)

(73) Assignee: **ABB Schweiz AG**, Baden (CH)

(**) Term: **15 Years**

(21) Appl. No.: **29/631,249**

(22) Filed: **Dec. 28, 2017**

(30) **Foreign Application Priority Data**

Sep. 29, 2017 (CN) 2017 3 0470525

(51) **LOC (11) Cl.** **13-03**

(52) **U.S. Cl.**
USPC **D13/162**

(58) **Field of Classification Search**

USPC D13/162, 162.1, 163, 199; D15/199
CPC ... B25J 9/16; B25J 9/161; B25J 9/1602; B25J 9/1065; G05B 19/18; G05B 19/19; G05B 19/418; G06F 1/26; G06F 1/266; G06F 1/28; H05K 7/0017; H05K 7/1462; H05K 7/1467; H05K 7/1468

See application file for complete search history.

(56) **References Cited**

U.S. PATENT DOCUMENTS

6,032,086 A * 2/2000 Hashimoto B25J 9/1602
312/223.6
D480,367 S * 10/2003 Droulin D13/162.1
D481,014 S * 10/2003 Droulin D13/162.1
7,577,497 B2 * 8/2009 Johannessen B25J 9/1674
318/568.11

D607,843 S * 1/2010 Borax D13/162
7,774,099 B2 * 8/2010 Kobayashi B25J 9/1671
318/560
8,141,962 B2 * 3/2012 Ohfuchi H05K 7/1467
312/201
8,421,268 B2 * 4/2013 Reese H05K 7/1467
307/38
2007/0119049 A1 * 5/2007 Teranaka B25J 9/1602
29/740

* cited by examiner

Primary Examiner — Selina Sikder

(74) *Attorney, Agent, or Firm* — Taft Stettinius & Hollister LLP

(57) **CLAIM**

The ornamental design for an industrial robot controller, as shown and described.

DESCRIPTION

FIG. 1 illustrates a front view of an industrial robot controller.

FIG. 2 illustrates a rear view of the industrial robot controller shown in FIG. 1.

FIG. 3 illustrates a left side view of the industrial robot controller shown in FIG. 1.

FIG. 4 illustrates a right side view of the industrial robot controller shown in FIG. 1.

FIG. 5 illustrates a top view of the industrial robot controller shown in FIG. 1.

FIG. 6 illustrates a bottom view of the industrial robot controller shown in FIG. 1.

FIG. 7 illustrates a bottom perspective view of the industrial robot controller shown in FIG. 1; and,

FIG. 8 illustrates an enlarged bottom perspective view of the industrial robot controller shown in FIG. 1.

1 Claim, 8 Drawing Sheets

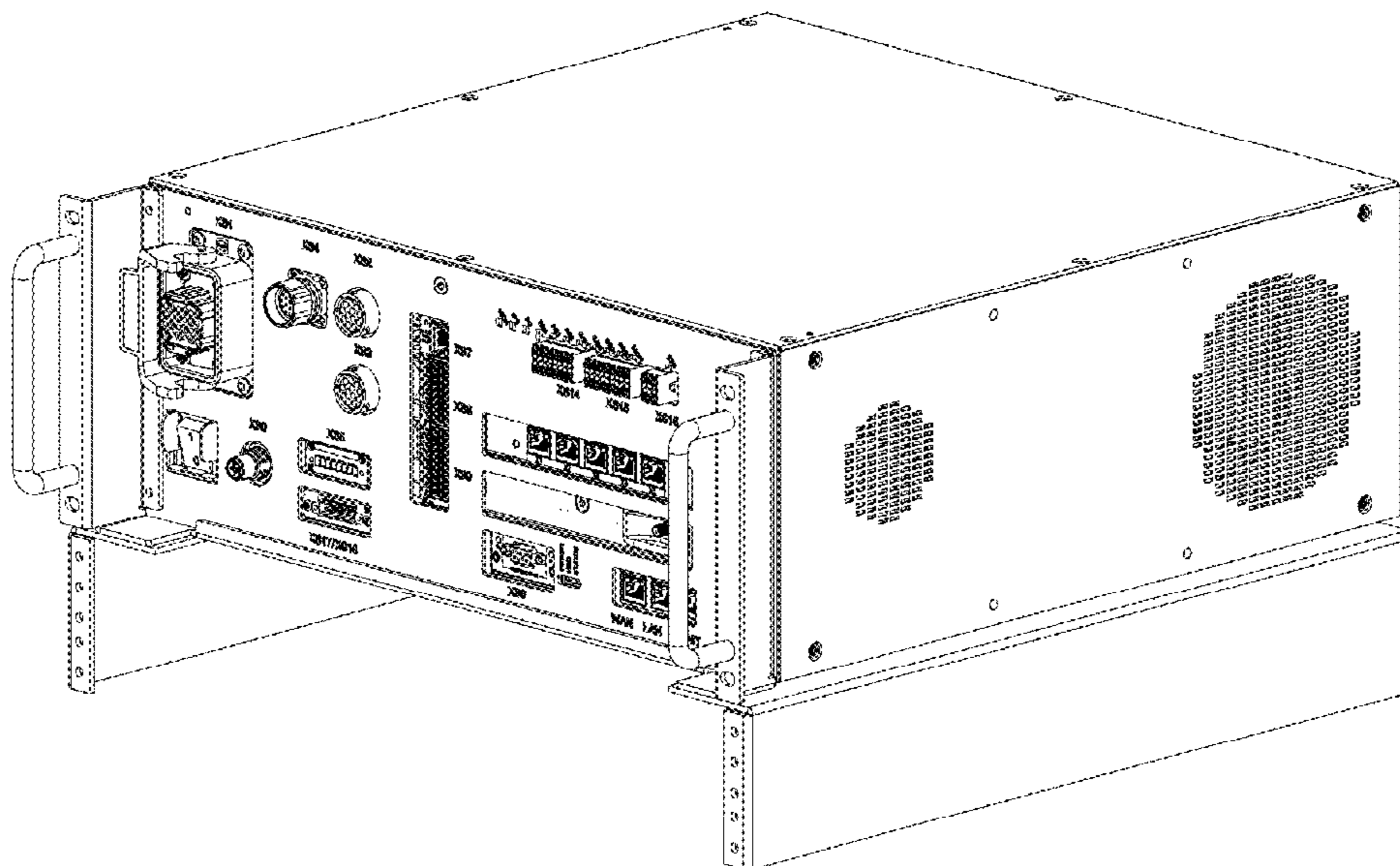

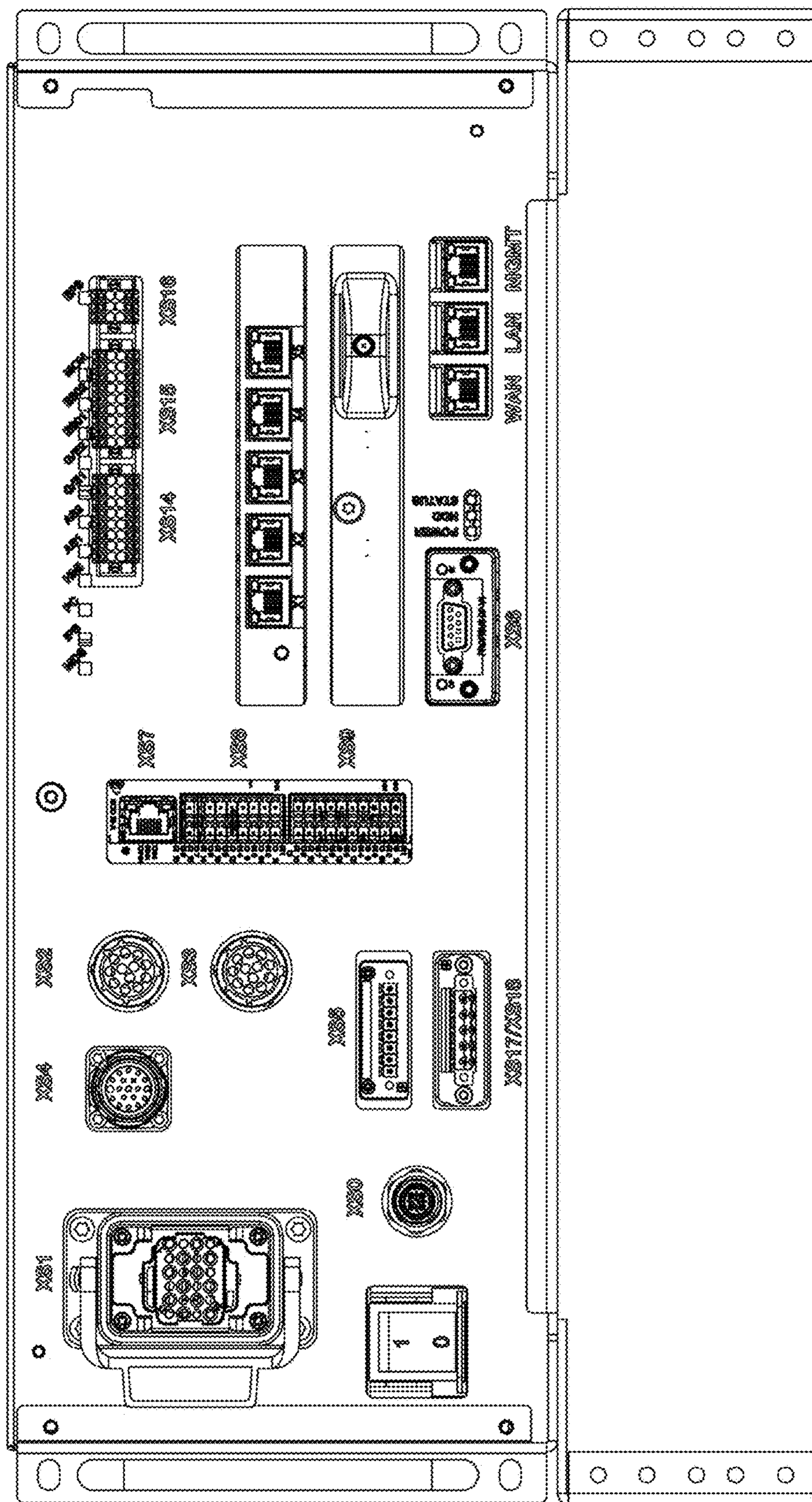

FIGURE 1

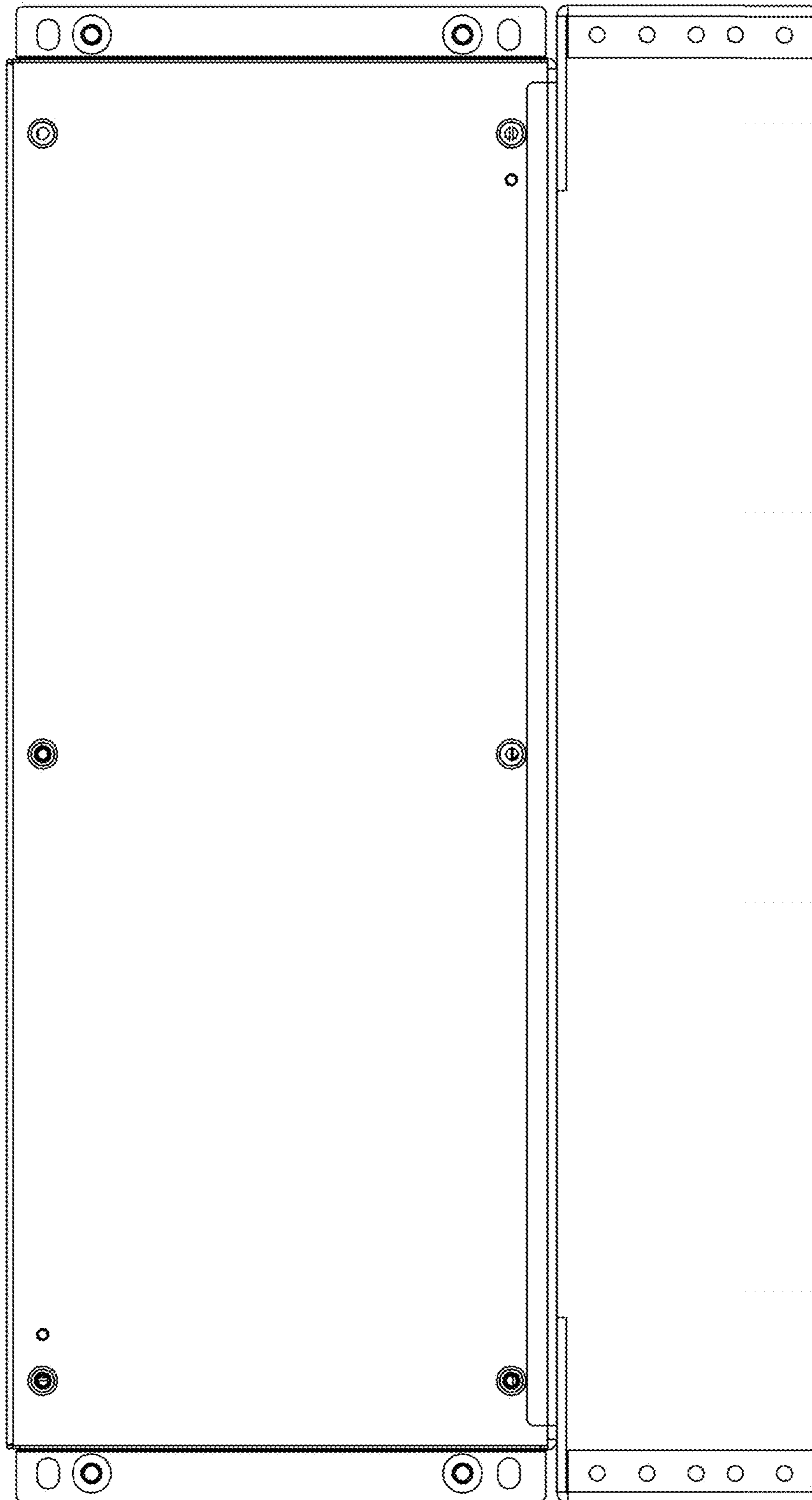

FIGURE 2

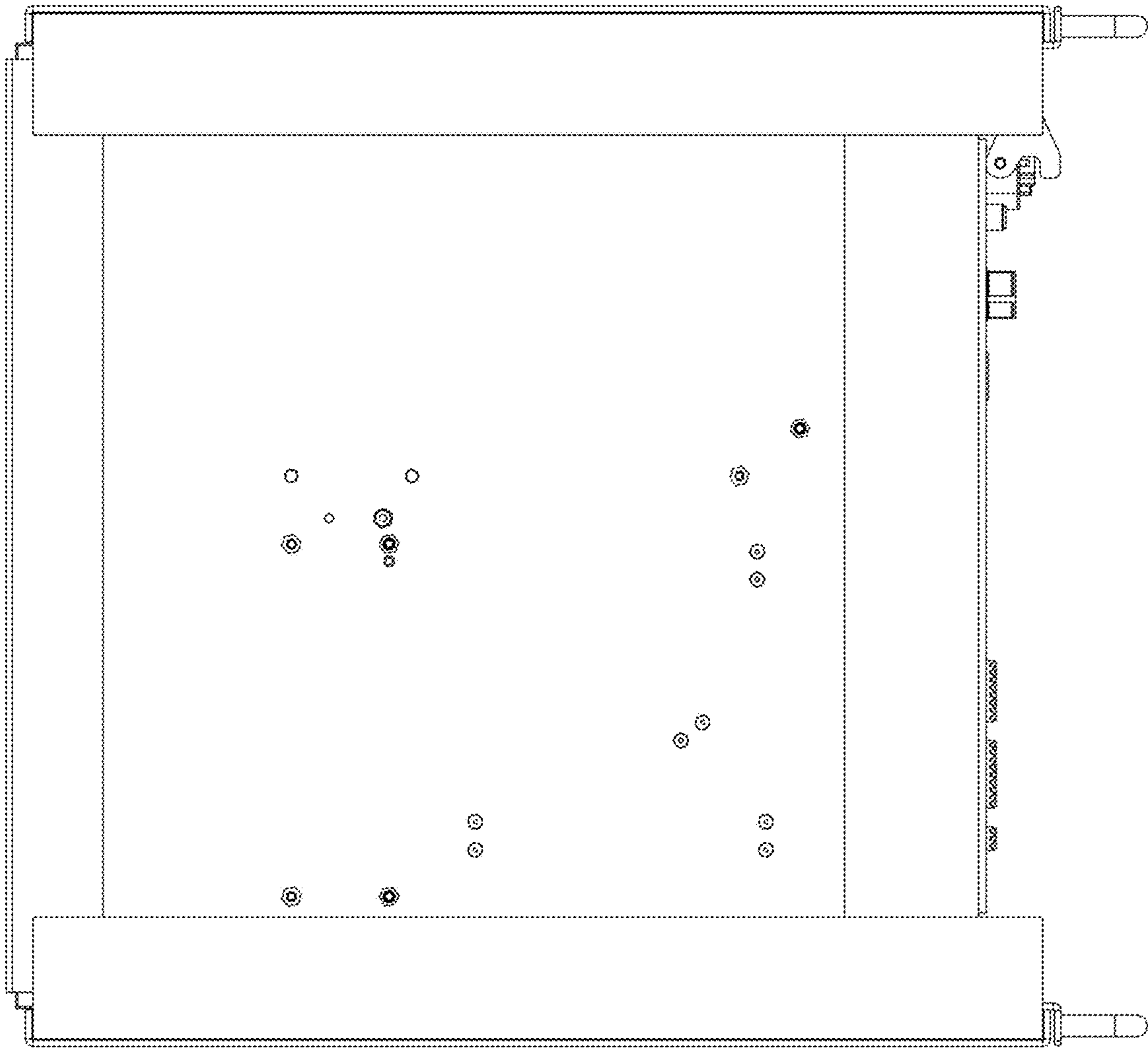

FIGURE 3

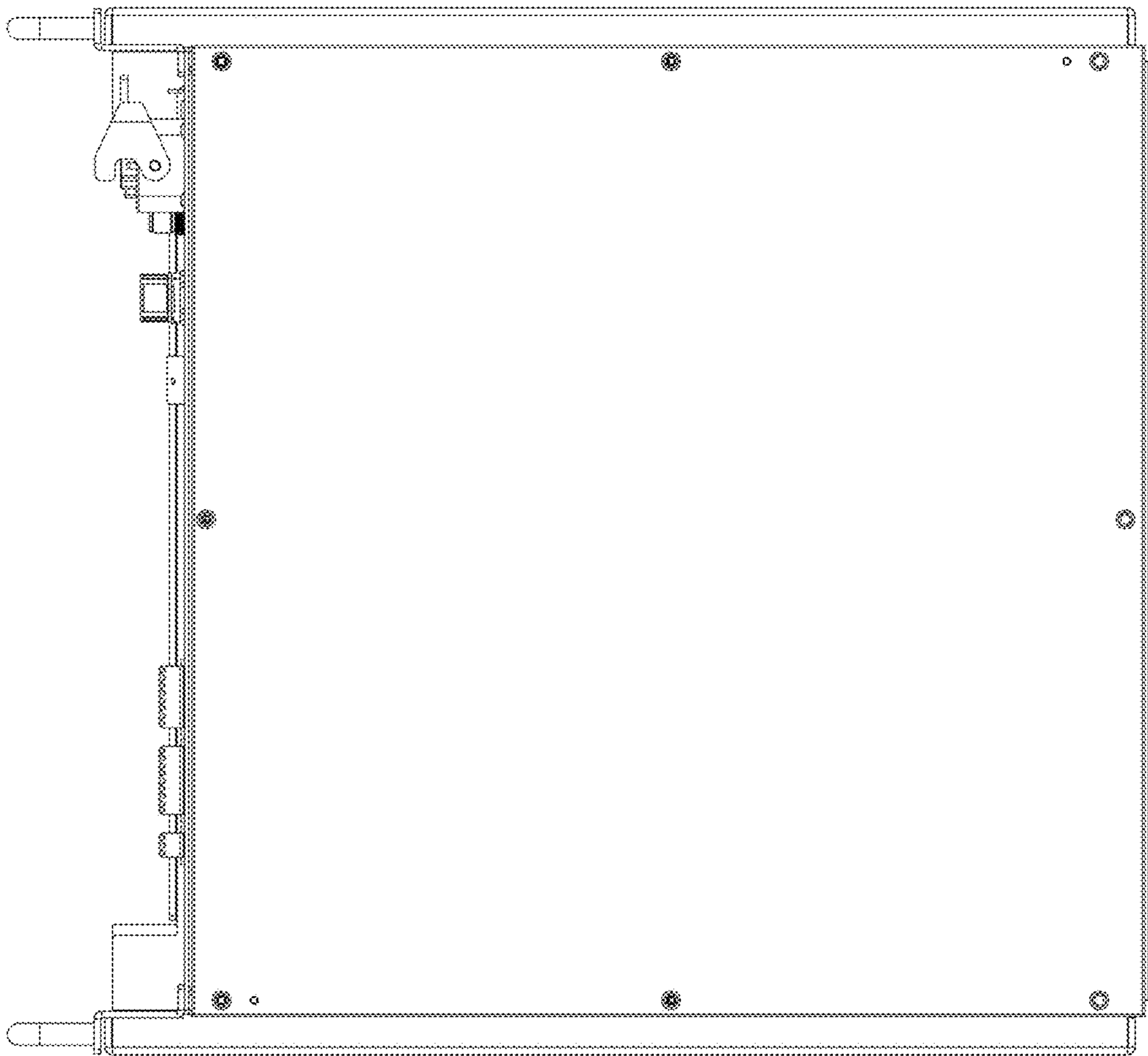

FIGURE 4

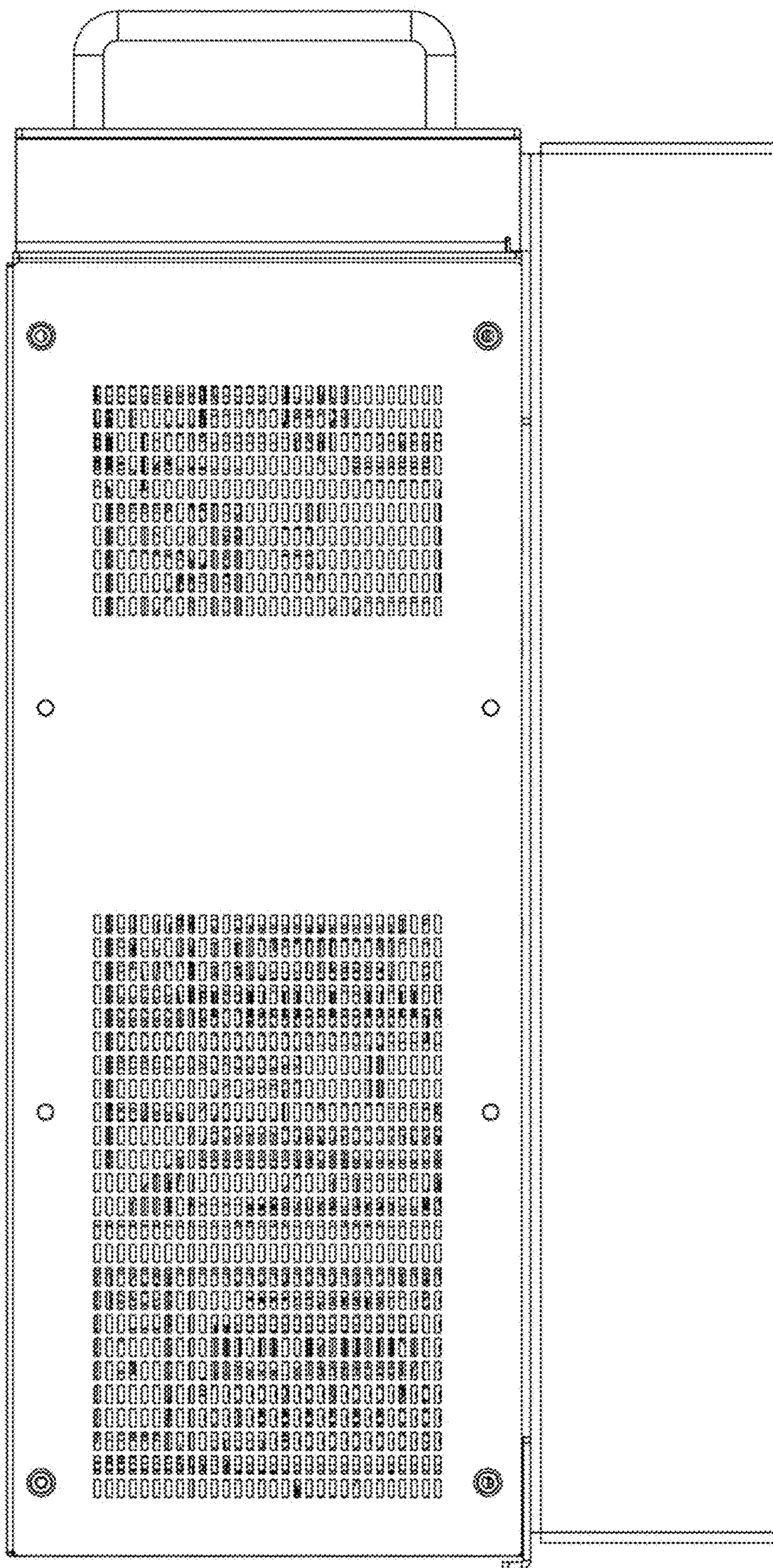

FIGURE 5

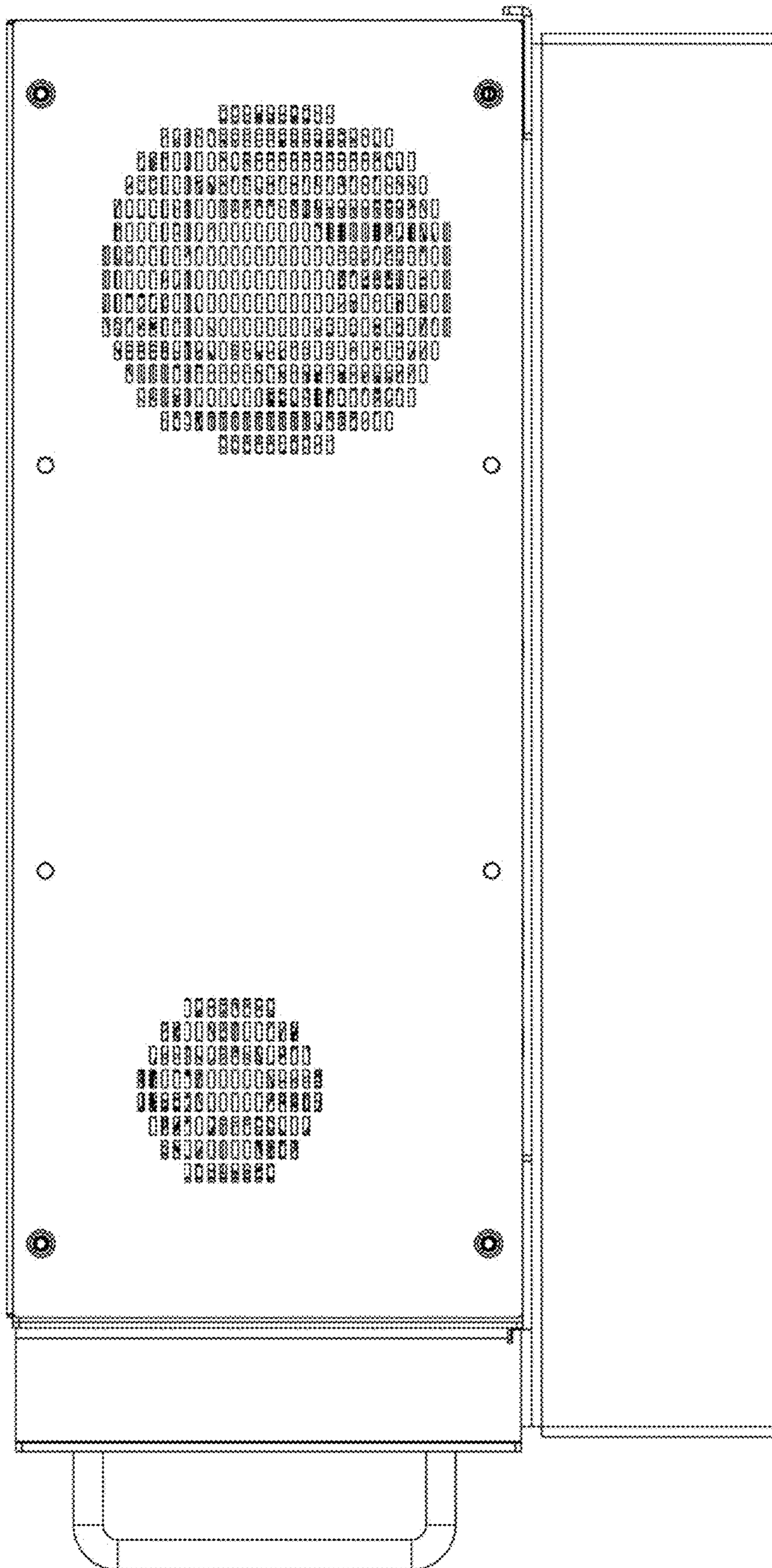

FIGURE 6

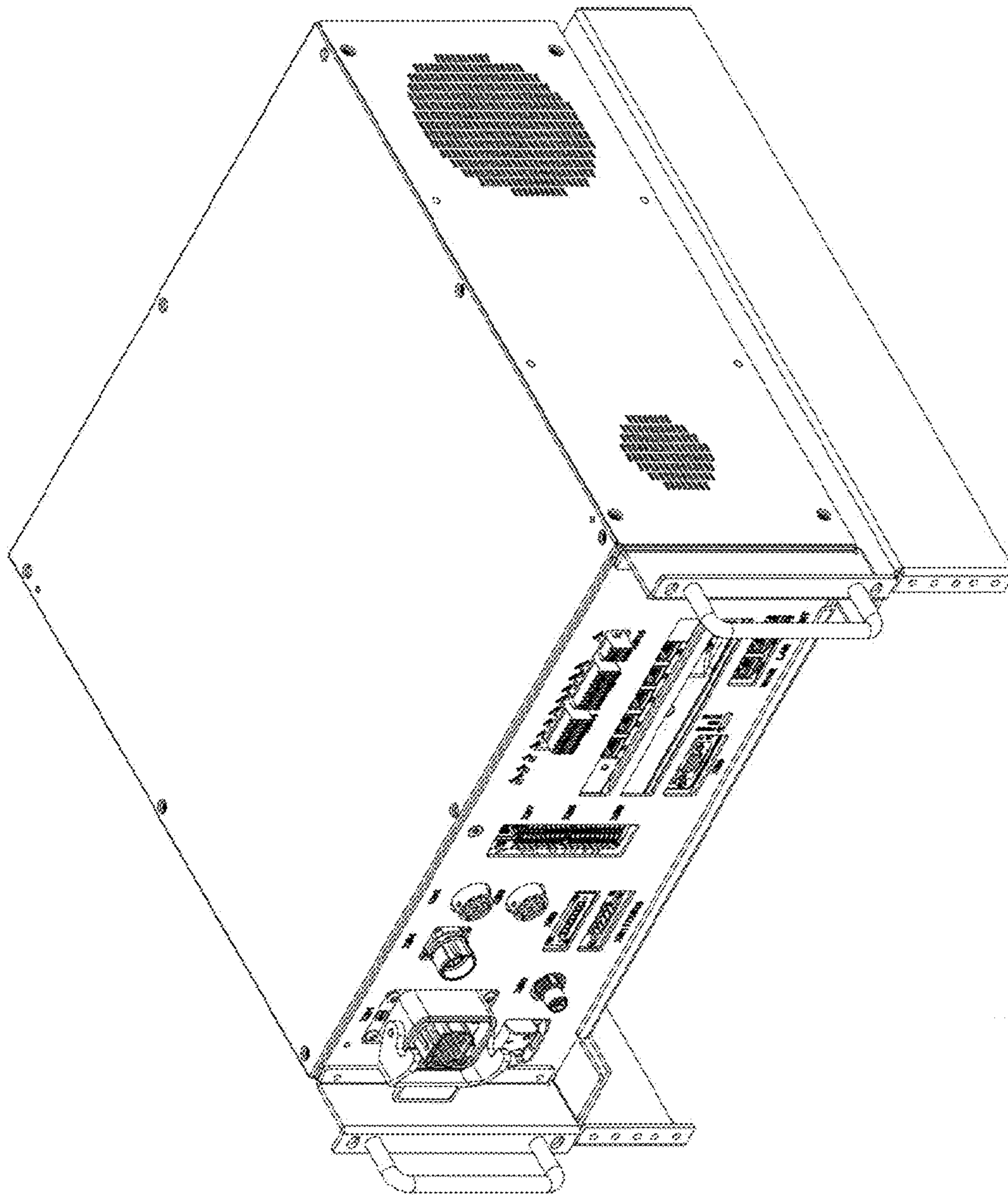

FIGURE 7

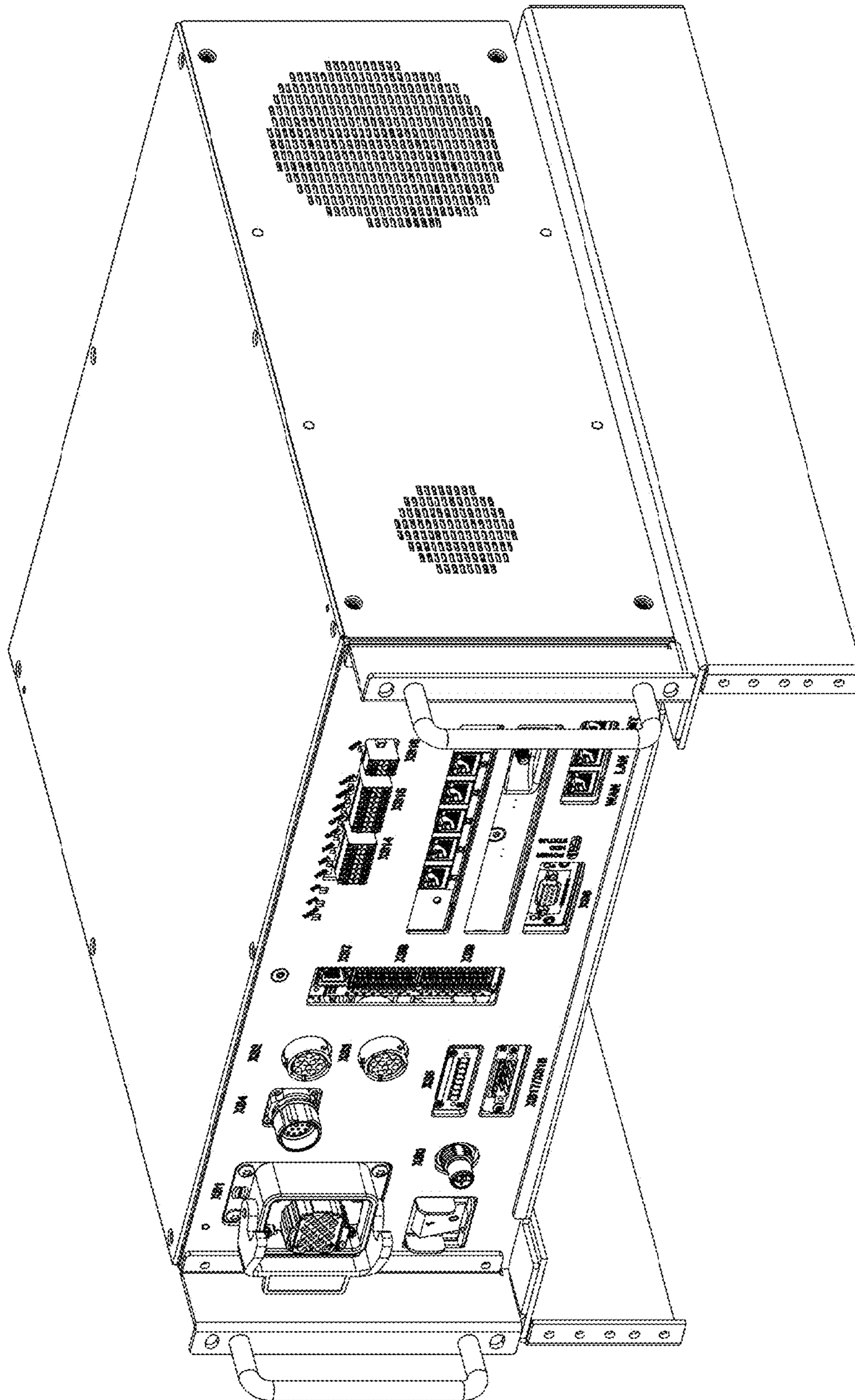

FIGURE 8