



US00D839535S

(12) **United States Design Patent** (10) **Patent No.:** **US D839,535 S**
Flower (45) **Date of Patent:** **** Feb. 5, 2019**

(54) **BRASSIERE**

(71) Applicant: **Under Armour, Inc.**, Baltimore, MD (US)

(72) Inventor: **Danielle Flower**, New York, NY (US)

(73) Assignee: **UNDER ARMOUR, INC.**, Baltimore, MD (US)

(**) Term: **15 Years**

(21) Appl. No.: **29/615,627**

(22) Filed: **Aug. 30, 2017**

(51) **LOC (11) Cl.** **02-01**

(52) **U.S. Cl.**
USPC **D2/706**

(58) **Field of Classification Search**
USPC D2/706–710, 711, 731, 735, 737, 635, D2/636
CPC A41C 3/00; A41C 3/14; A41C 5/00; A41C 3/0057; A41C 3/0014; A41C 3/144; A41B 9/001; A41B 9/14
See application file for complete search history.

(56) **References Cited**

U.S. PATENT DOCUMENTS

D381,188 S *	7/1997	Allen	D2/706
D641,133 S *	7/2011	Zarabi	D2/708
D747,843 S *	1/2016	Gallo	D2/708
D783,930 S *	4/2017	Rothert	D2/708

(Continued)

FOREIGN PATENT DOCUMENTS

CA	2921010 C *	4/2018	A41C 3/00
WO	WO-2017130311 A1 *	8/2017	A41C 3/00

OTHER PUBLICATIONS

Dicks sporting goods. Link: <https://www.dickssportinggoods.com/p/under-armour-womens-breathelux-mid-sports-bra->

17uarwfshnmdbrrxxxapu/17uarwfshnmdbrrxxxapu?recid=Product_PageElement_product_rr_3_5123_&rrec=true. Visited Jul. 15, 2018. Under Armour Women's Breathelux Mid Sports Bra. (Year: 2018).*

(Continued)

Primary Examiner — Brandon M Rosati

Assistant Examiner — Lauren D McVey

(74) *Attorney, Agent, or Firm* — Edell, Shapiro & Finnan, LLC

(57) **CLAIM**

The ornamental design for a brassiere, as shown and described.

DESCRIPTION

FIG. 1 is a front perspective view of a first embodiment of a brassiere showing my new design; FIG. 2 is a rear perspective view of the brassiere of FIG. 1; FIG. 3 is a front view of the brassiere of FIG. 1; FIG. 4 is a rear view of the brassiere of FIG. 1; FIG. 5 is a right side view of the brassiere of FIG. 1; FIG. 6 is a left side view of the brassiere of FIG. 1; FIG. 7 is a top view of the brassiere of FIG. 1; FIG. 8 is a bottom view of the brassiere of FIG. 1. FIG. 9 is a front perspective view of a second embodiment of a brassiere showing my new design; FIG. 10 is a rear perspective view of the brassiere of FIG. 9; FIG. 11 is a front view of the brassiere of FIG. 9; FIG. 12 is a rear view of the brassiere of FIG. 9; FIG. 13 is a right side view of the brassiere of FIG. 9; FIG. 14 is a left side view of the brassiere of FIG. 9; FIG. 15 is a top view of the brassiere of FIG. 9; and, FIG. 16 is a bottom view of the brassiere of FIG. 9. The broken lines shown in the views are directed to environment and are for illustrative purposes only; the broken lines form no part of the claimed design. The crosshatching depicted in the views indicates a continuous contrast in appearance throughout the surface on which the pattern is shown.

1 Claim, 16 Drawing Sheets

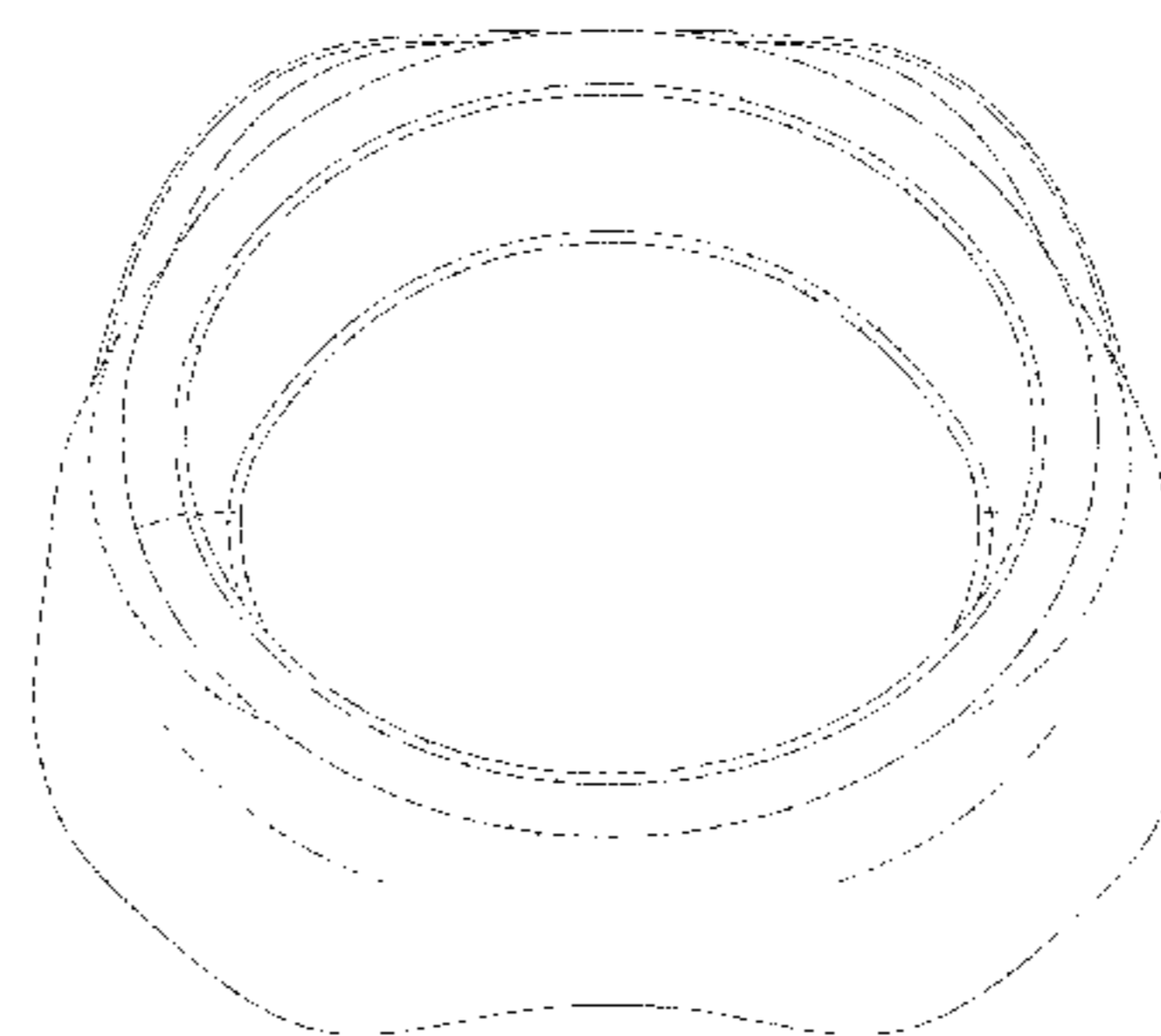
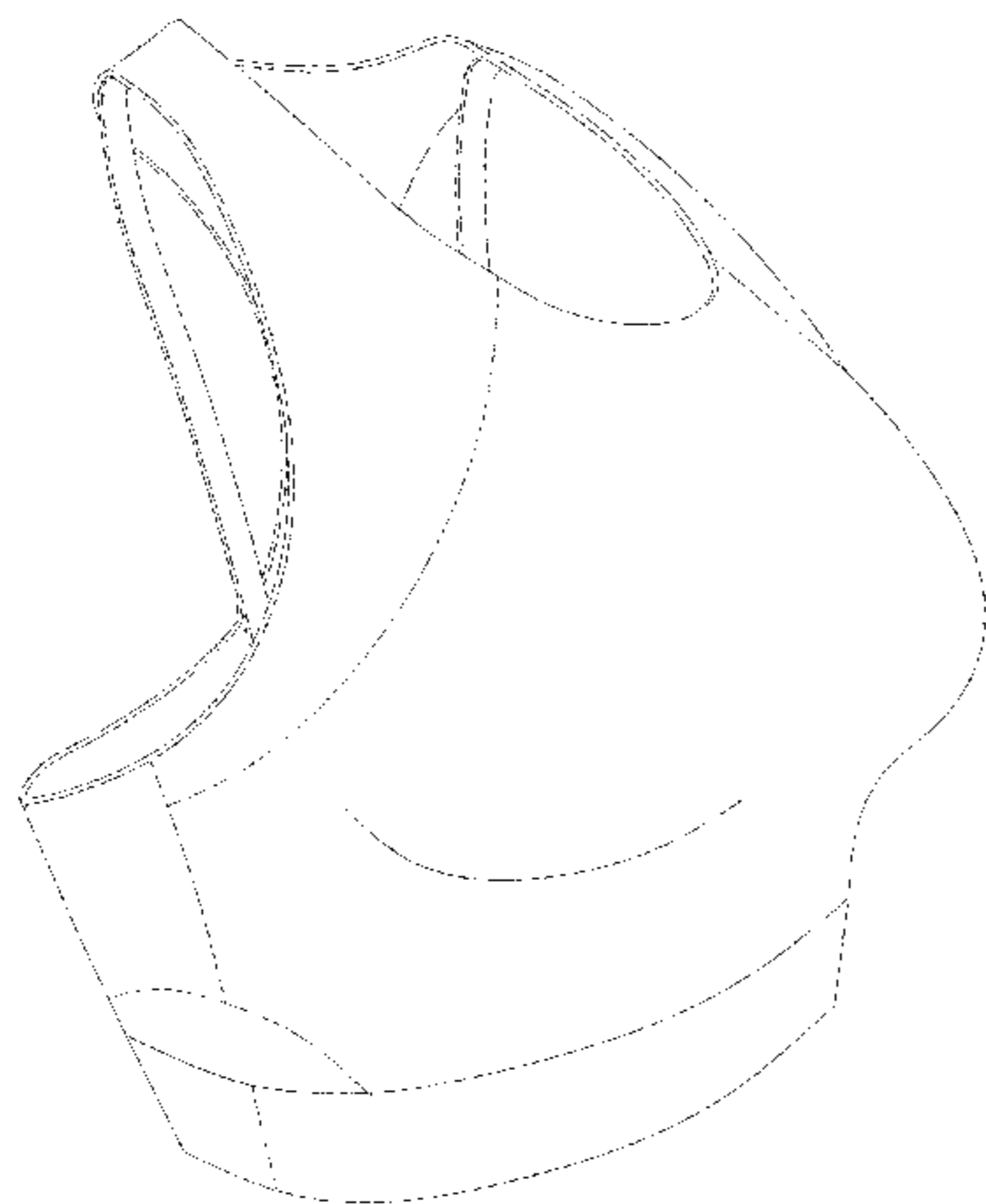

(56)

References Cited

U.S. PATENT DOCUMENTS

D800,992 S * 10/2017 Flower D2/708
9,795,821 B2 * 10/2017 Feldman A63B 21/065
D821,700 S * 7/2018 Flower D2/706
D821,703 S * 7/2018 Flower D2/708
10,010,117 B1 * 7/2018 Rendone A41C 3/0014
2012/0122370 A1 * 5/2012 Heath A41C 3/0057
450/80
2017/0360118 A1 * 12/2017 Randall A41C 3/12
2018/0184740 A1 * 7/2018 Kovatch A41C 3/0057

OTHER PUBLICATIONS

Amazon. Link: https://www.amazon.com/City-Racerback-Workout-Support-Athletic/dp/B07F6892S1/ref=pd_sim_193_7?_encoding=UTF8&pd_rd_i=B07F6892S1&pd%20%80%A6. Jul. 2, 2018. V for City Womens Racerback Sports Bra. (Year: 2018).*

* cited by examiner

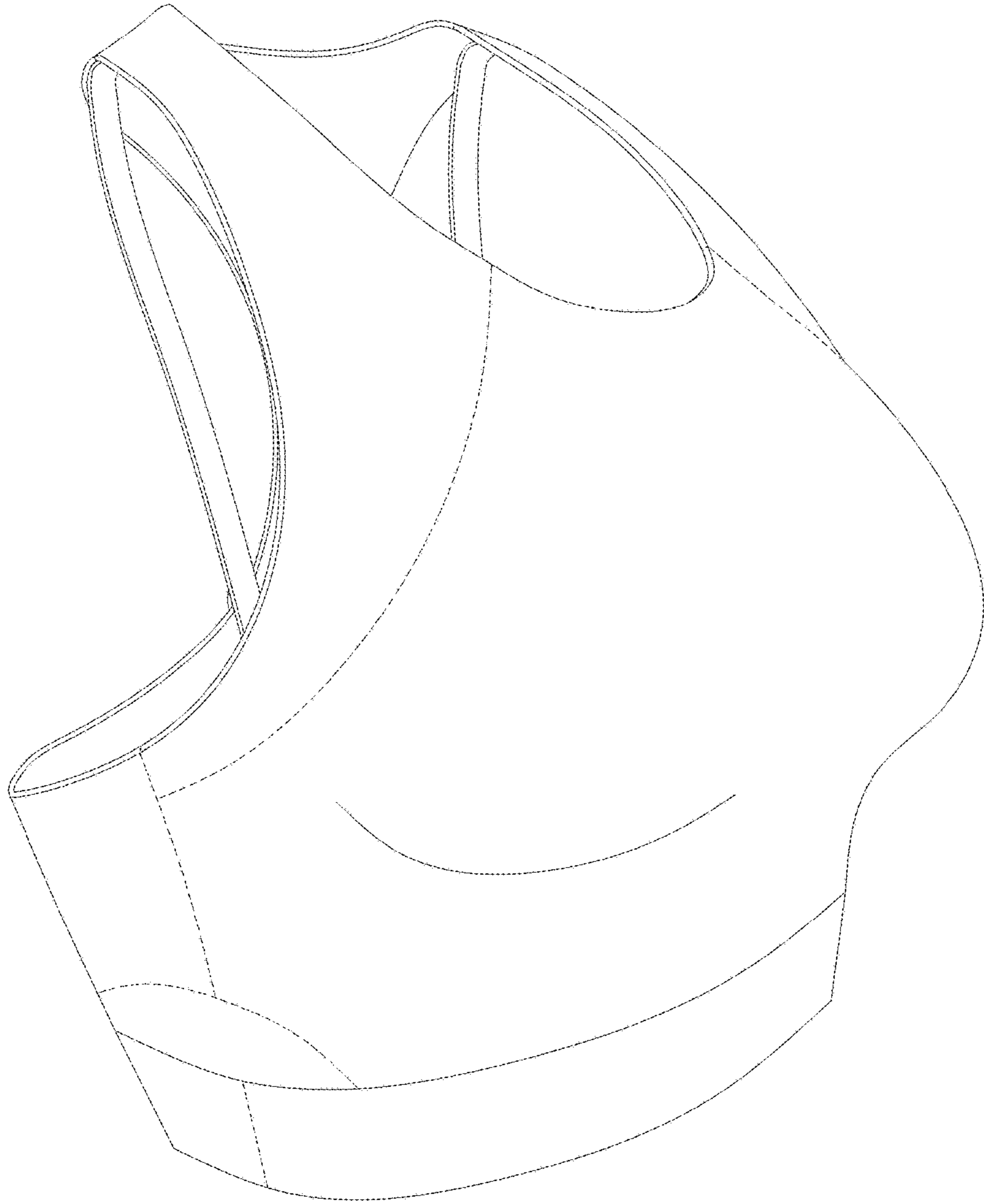

FIG.1

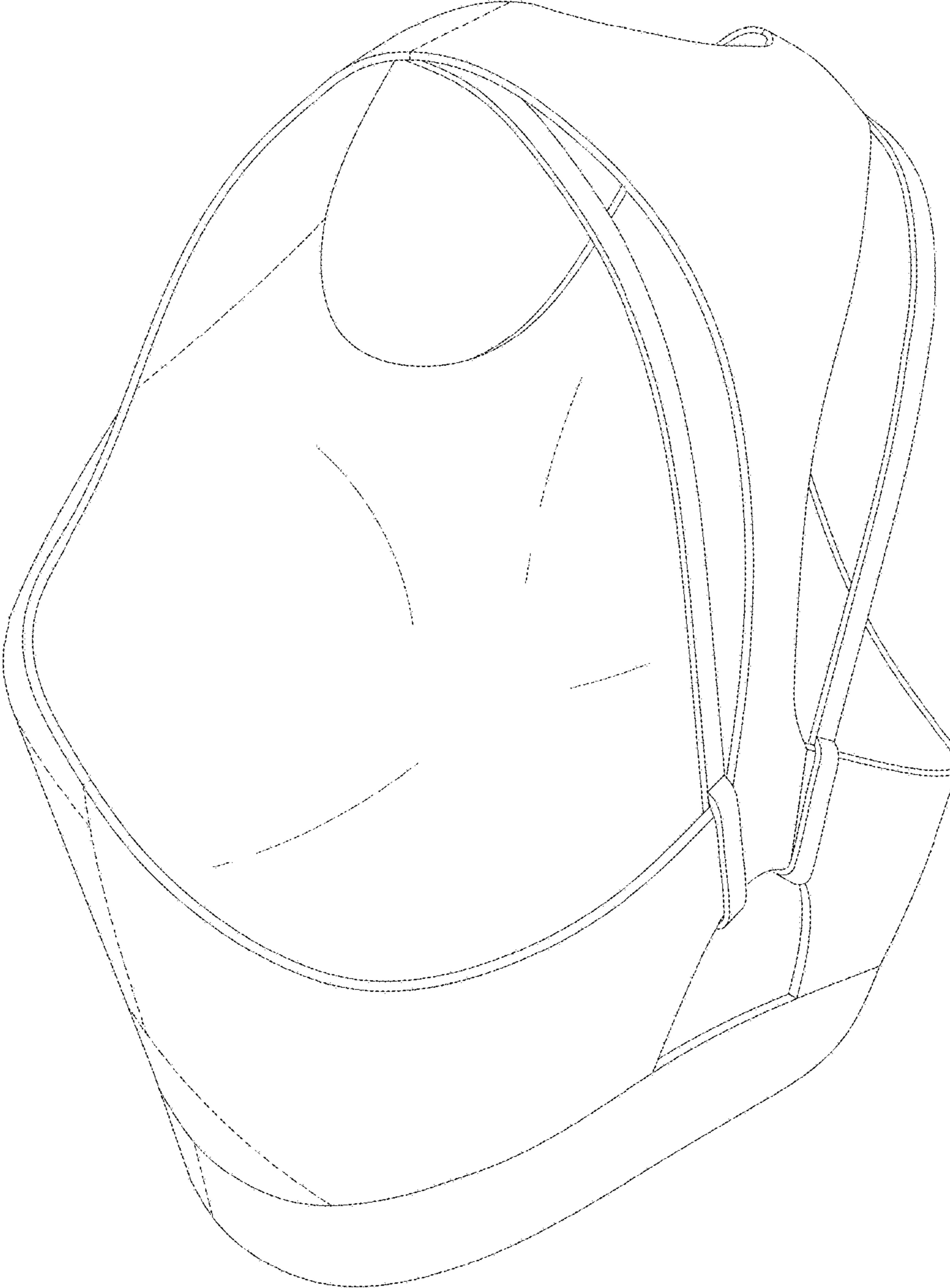

FIG. 2

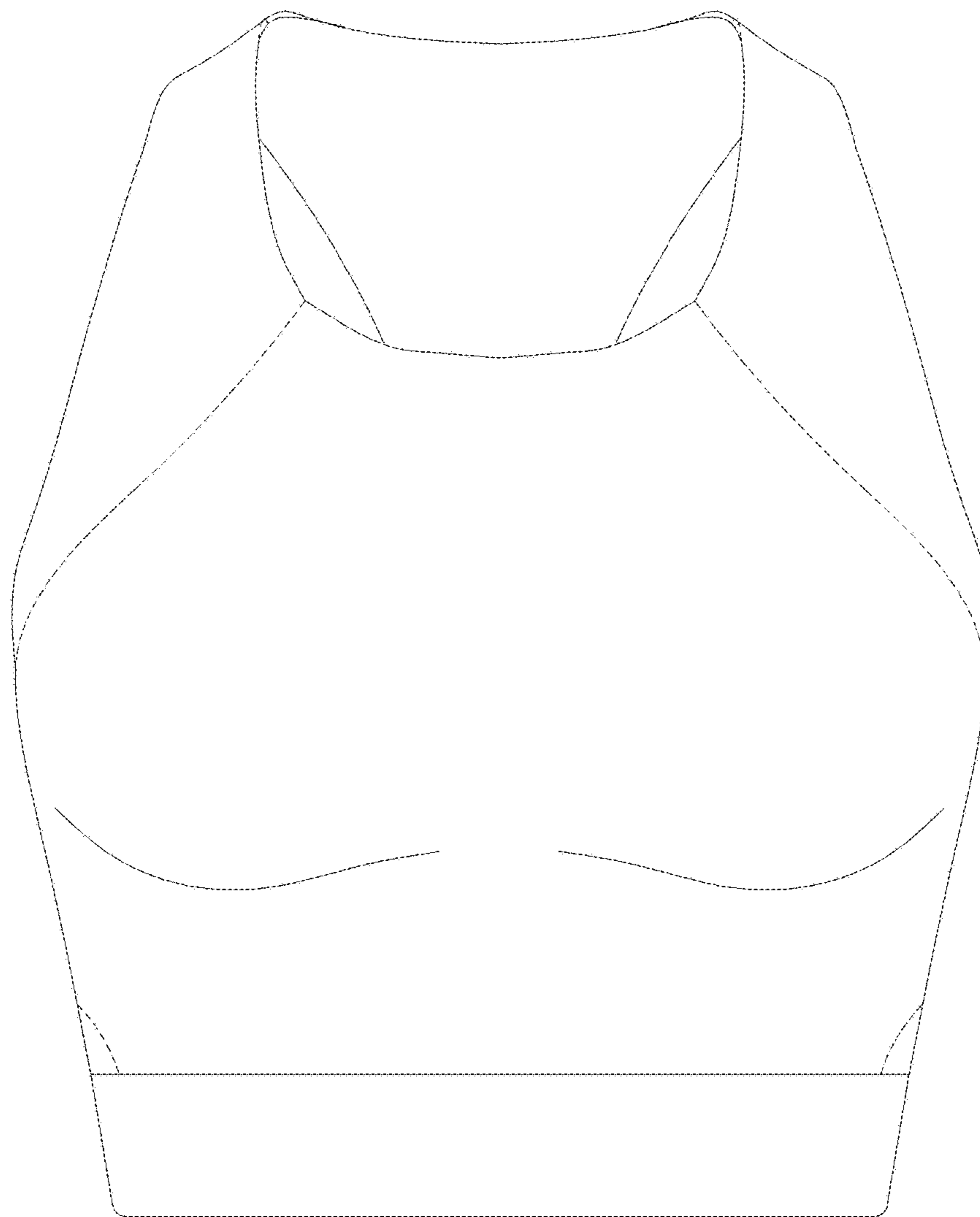

FIG.3

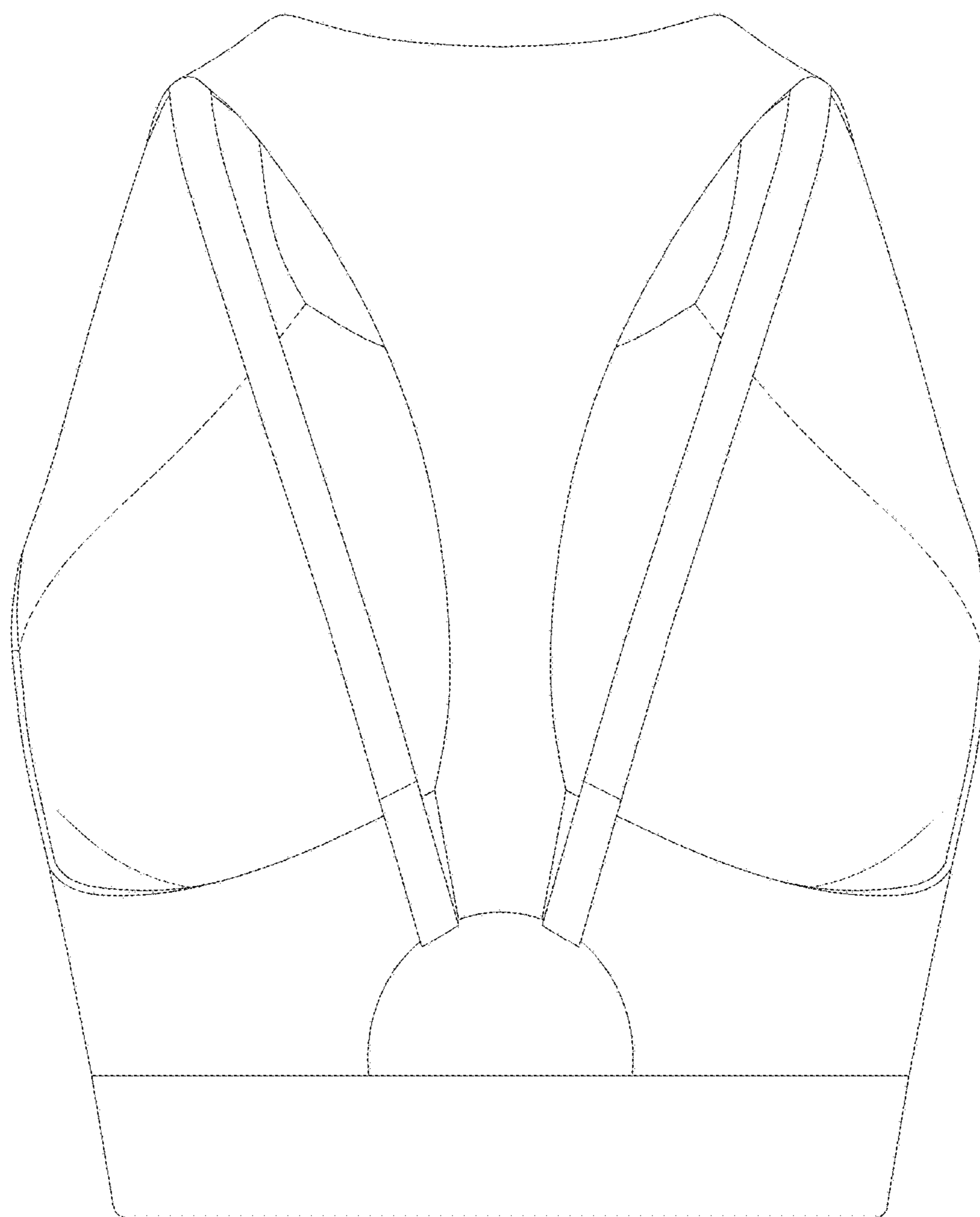

FIG.4

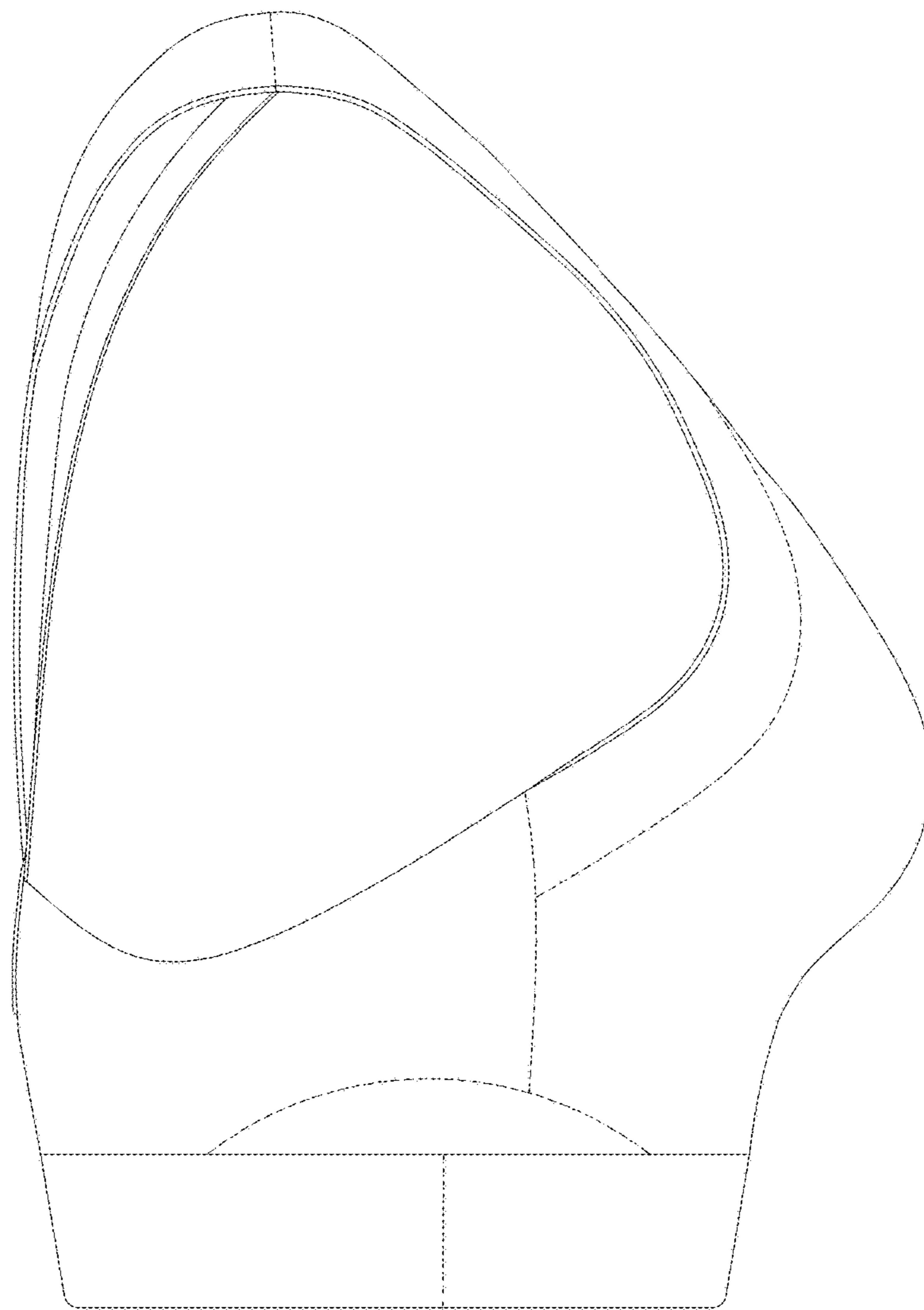

FIG.5

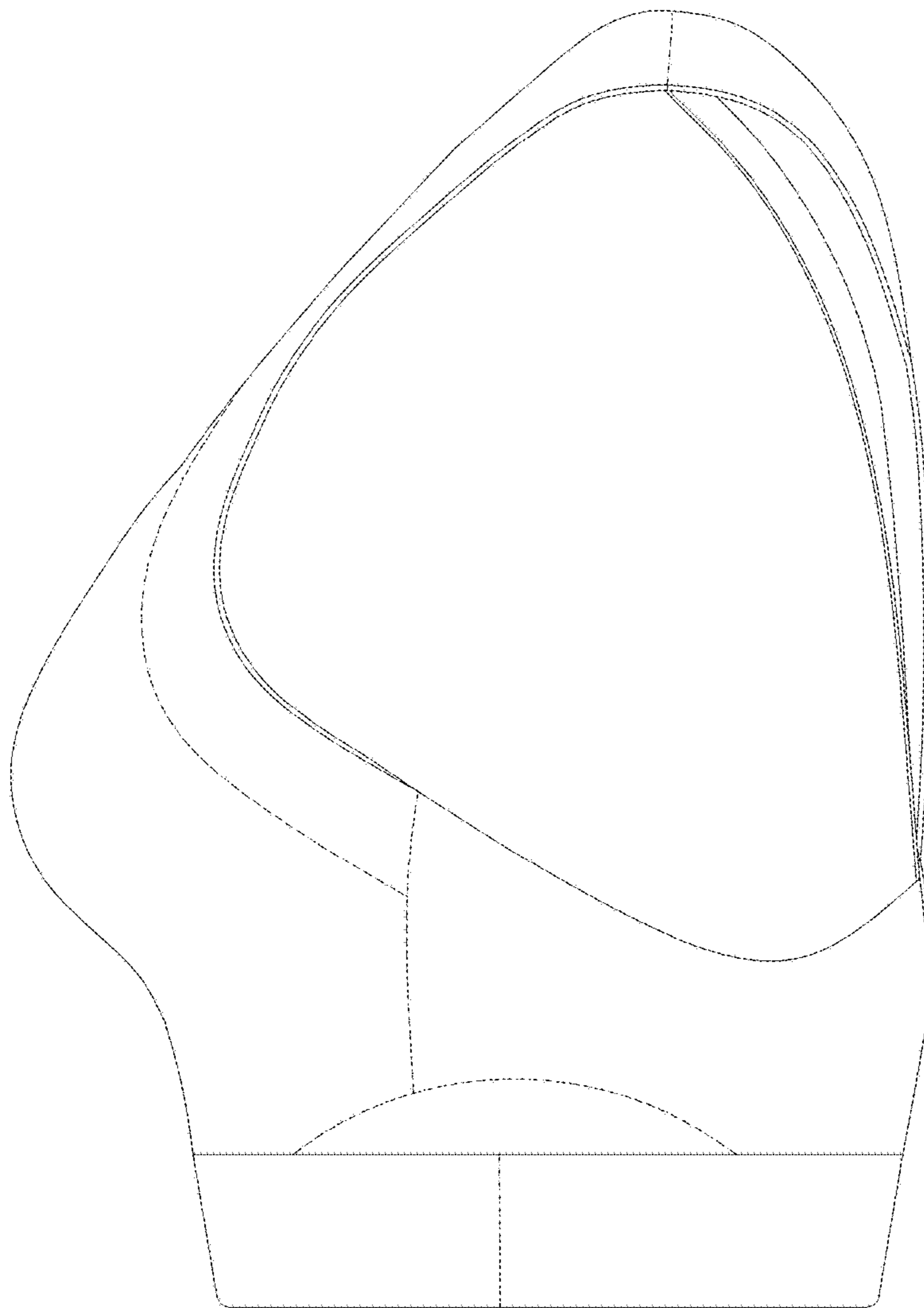

FIG.6

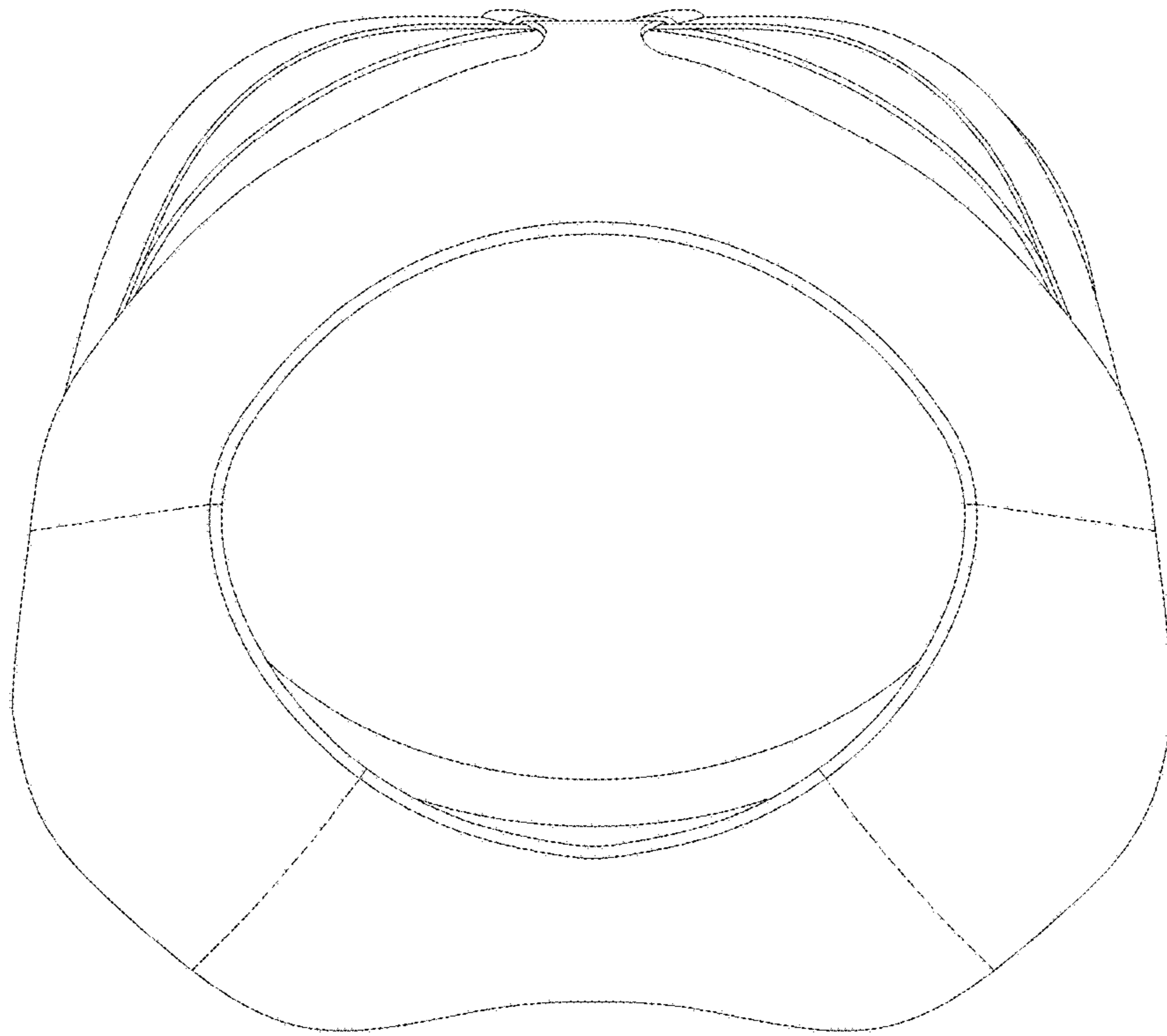

FIG. 7

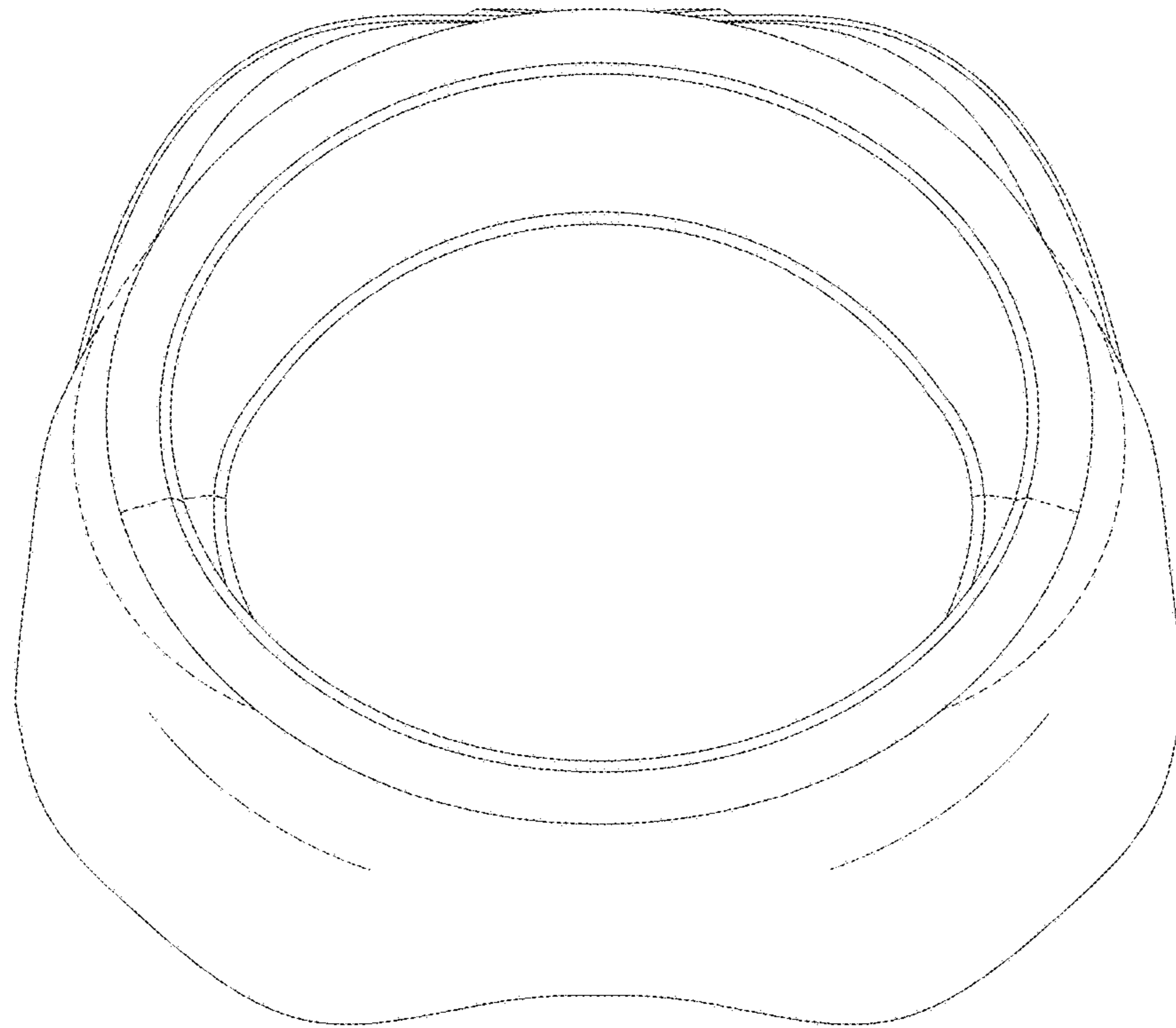

FIG.8

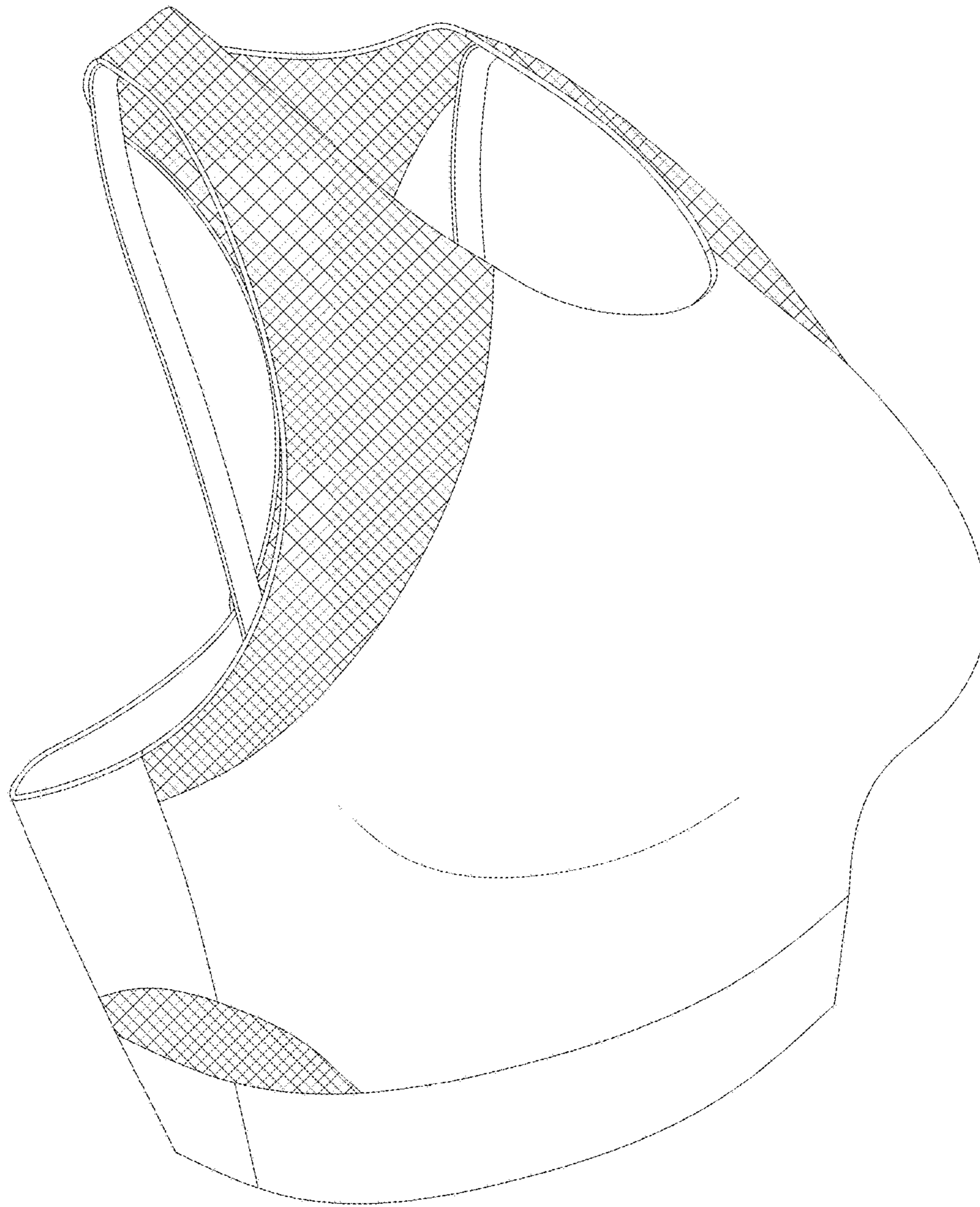

FIG.9

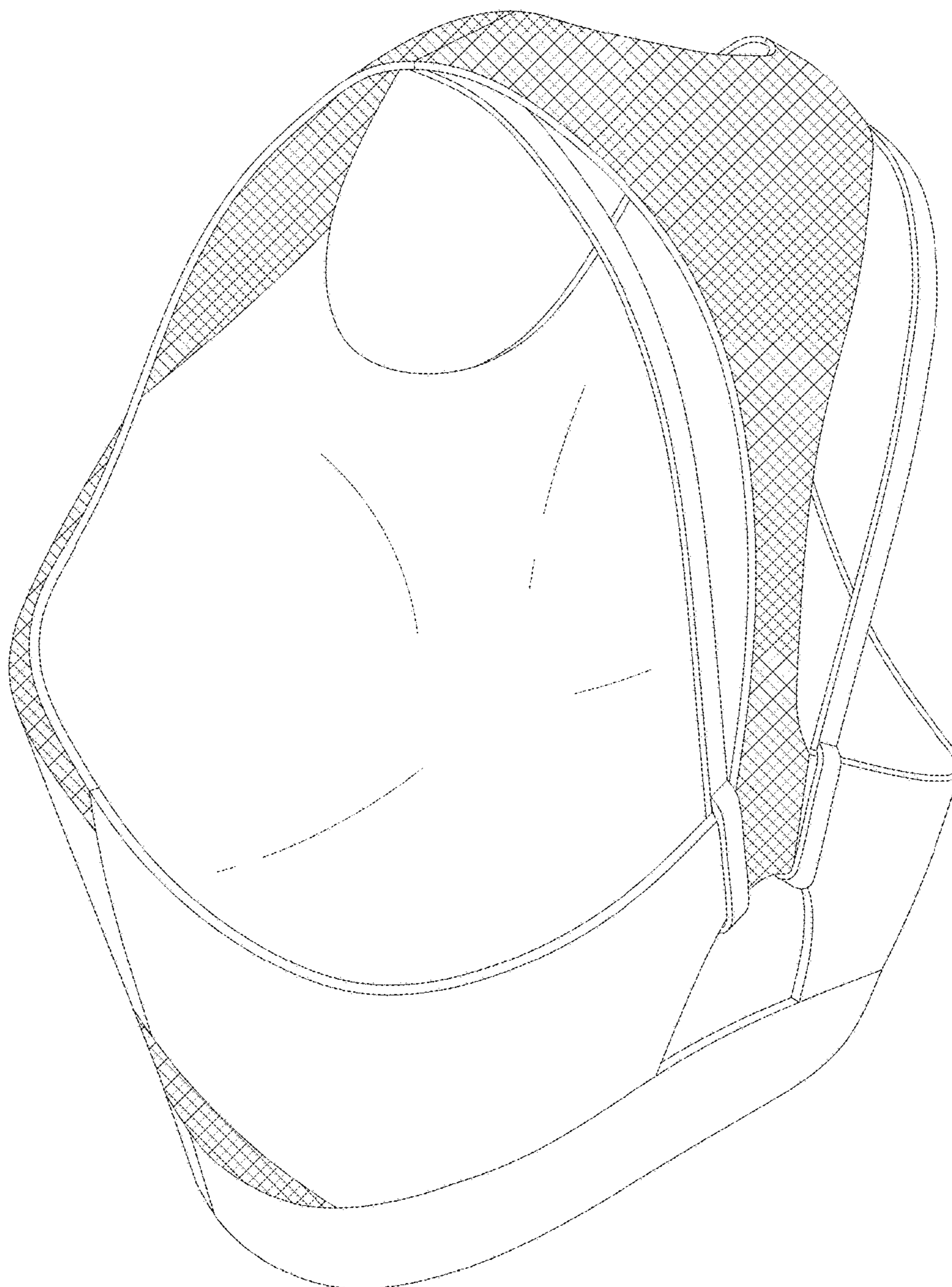

FIG.10

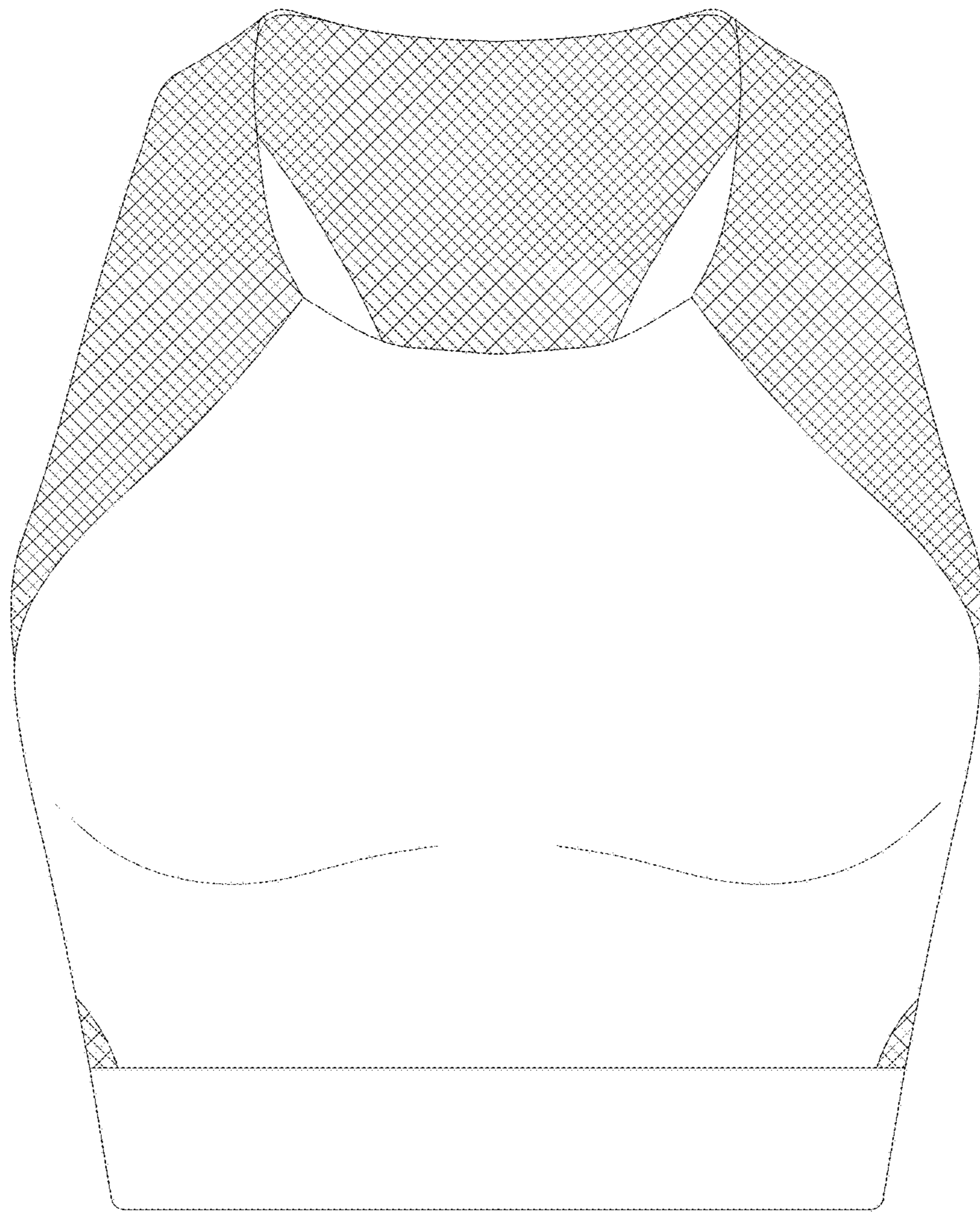

FIG.11

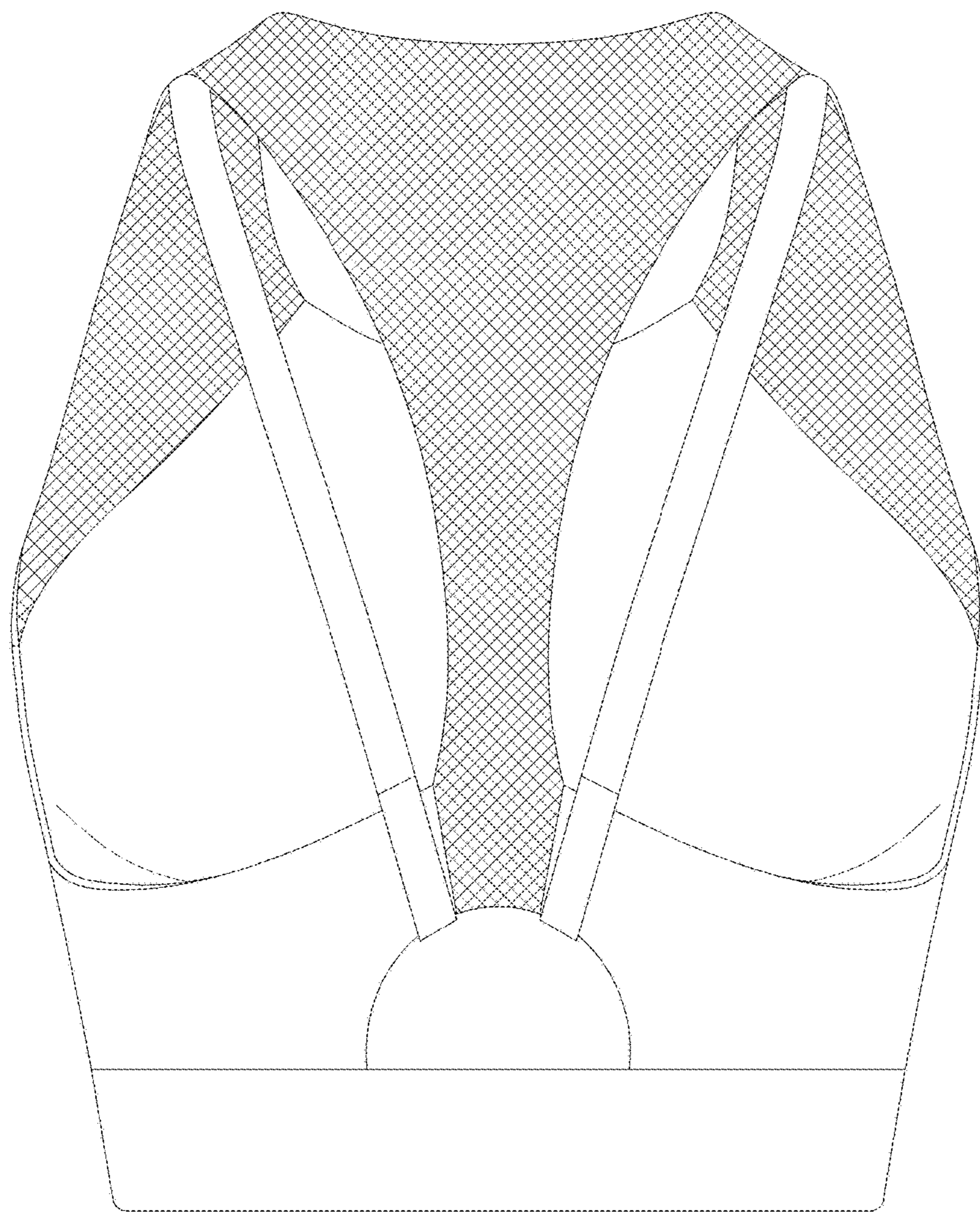

FIG.12

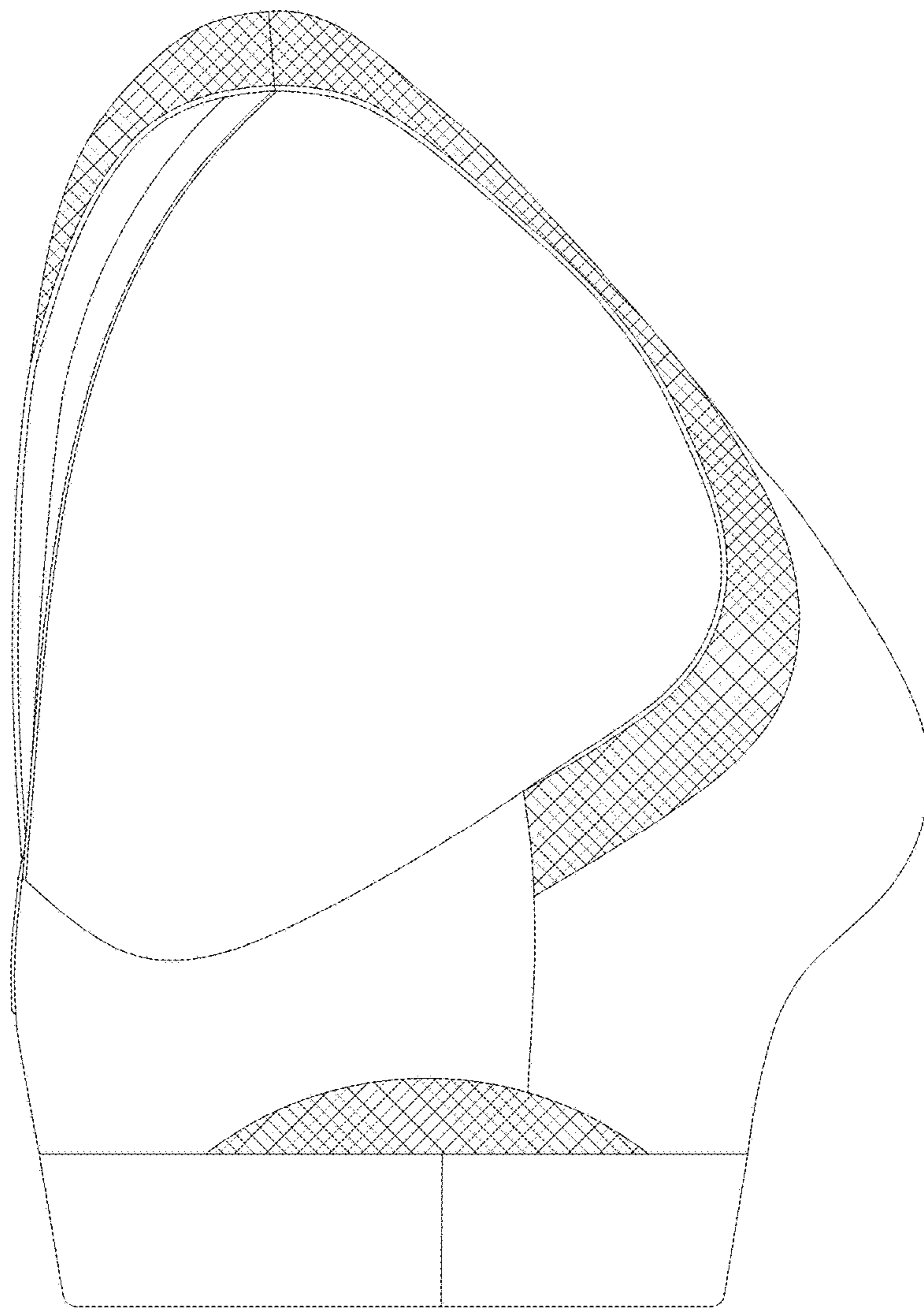

FIG.13

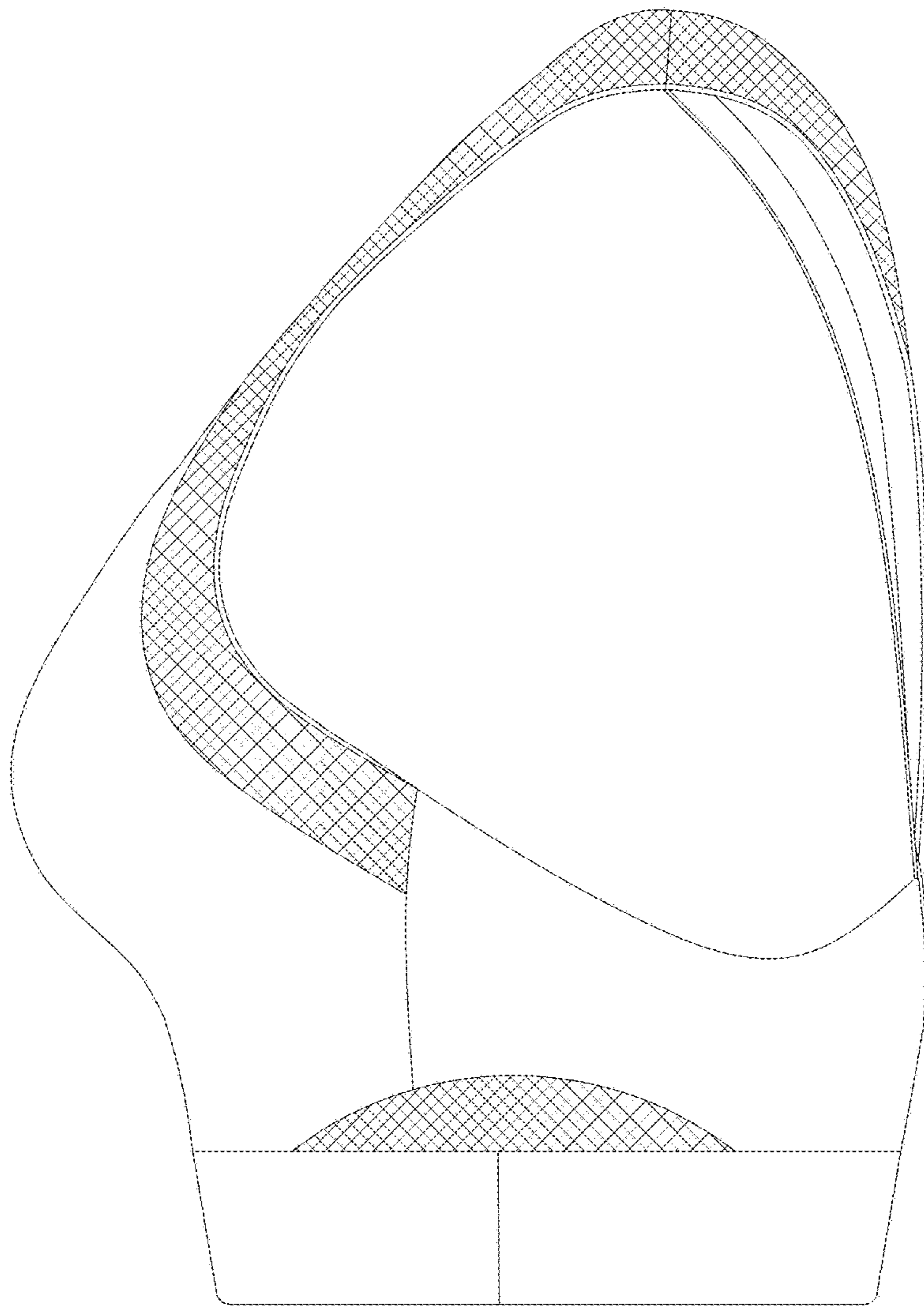

FIG.14

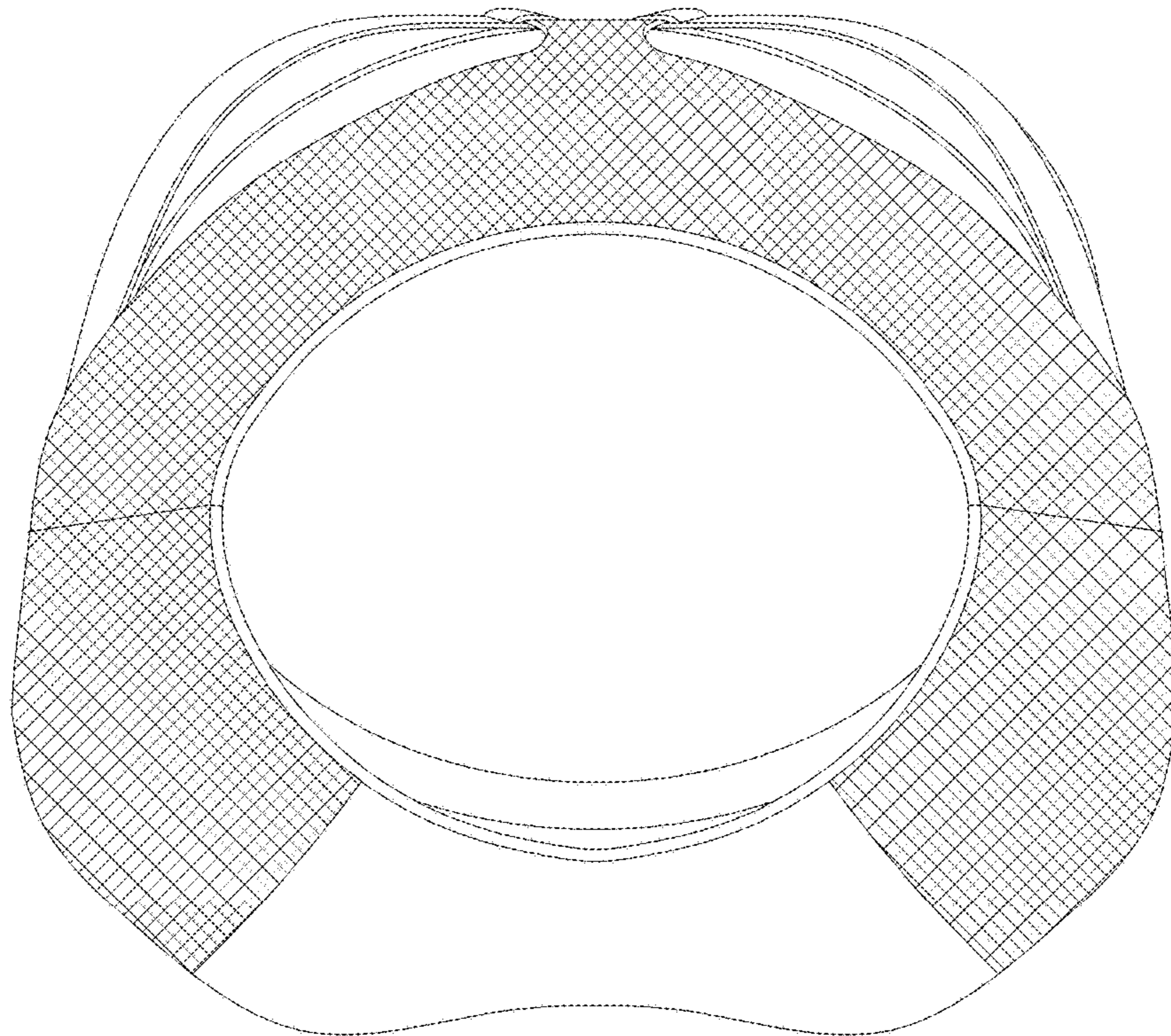

FIG.15

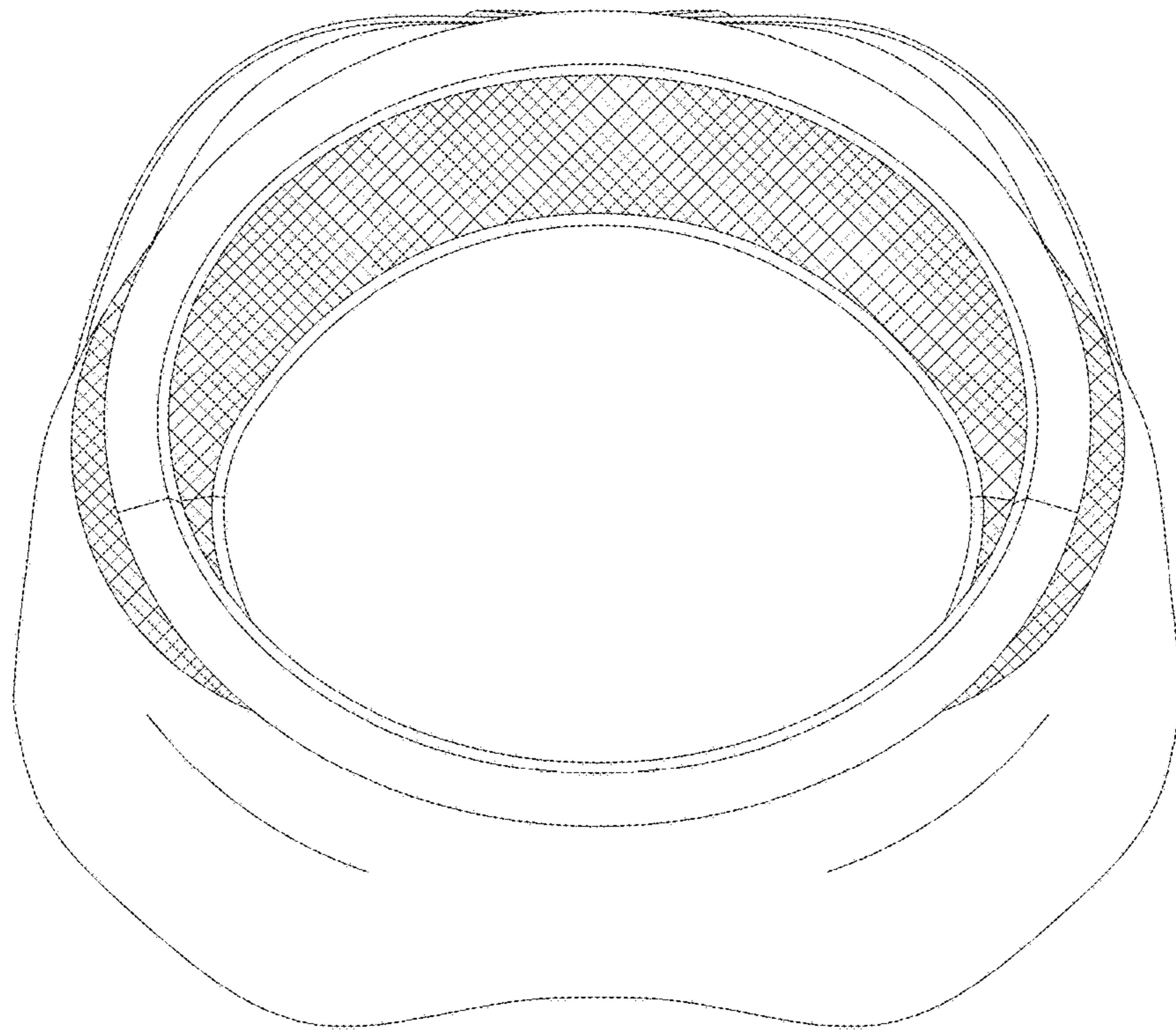

FIG.16