



US00D839531S

(12) **United States Design Patent** (10) **Patent No.:** **US D839,531 S**
Güven (45) **Date of Patent:** **** Feb. 5, 2019**

(54) **CHOCOLATE**
(71) Applicant: **ETI GIDA SANAYI VE TICARET ANONIM SIRKETI**, Eskisehir (TR)
(72) Inventor: **Gülay Gamze Güven**, Istanbul (TR)
(**) Term: **15 Years**
(21) Appl. No.: **29/597,148**
(22) Filed: **Mar. 14, 2017**
(51) **LOC (11) Cl.** **01-01**
(52) **U.S. Cl.**
USPC **D1/109**
(58) **Field of Classification Search**
USPC D1/100–130, 199; 426/92, 94, 104, 134, 426/138, 143, 275, 277, 279, 281–284, 426/292, 295, 391, 496, 514, 566, 572, 426/660; D21/577, 604, 605; D9/608; D24/102; D7/676; D11/31, 49, 82; D6/598; 446/369
CPC A23G 3/54; A61K 9/2072; A61K 9/0004; A61K 9/2095; A61K 9/209
See application file for complete search history.

D330,509 S * 10/1992 Belknap D13/183
D335,199 S * 5/1993 Kesdekoglu D1/110
D357,768 S * 4/1995 Ng D30/106
D429,329 S * 8/2000 Kobayashi D24/101
D430,662 S * 9/2000 Kobayashi D24/101
D432,229 S * 10/2000 Harris D24/102
D592,827 S * 5/2009 Mederer D1/110

* cited by examiner

Primary Examiner — Katie Jane Stofko
(74) *Attorney, Agent, or Firm* — Crose Law LLC;
Bradley D. Crose

(57) **CLAIM**

The ornamental design for a chocolate, as shown and described.

DESCRIPTION

FIG. 1 is a top view of a chocolate, showing my new design;
FIG. 2 is a bottom view of a chocolate, showing my new design;
FIG. 3 is a left side view of a chocolate, showing my new design;
FIG. 4 is a right side view of a chocolate, showing my new design;
FIG. 5 is a front view of a chocolate, showing my new design;
FIG. 6 is back view of a chocolate, showing my new design;
and,
FIG. 7 is front perspective view of a chocolate, showing my new design.

1 Claim, 7 Drawing Sheets

(56) **References Cited**
U.S. PATENT DOCUMENTS
D186,579 S * 11/1959 Cena D1/108
D210,365 S * 3/1968 Kroninger D1/110
D220,330 S * 3/1971 Tripp D1/110
D295,008 S * 4/1988 Codding D21/604
D327,358 S * 6/1992 Davis D1/106

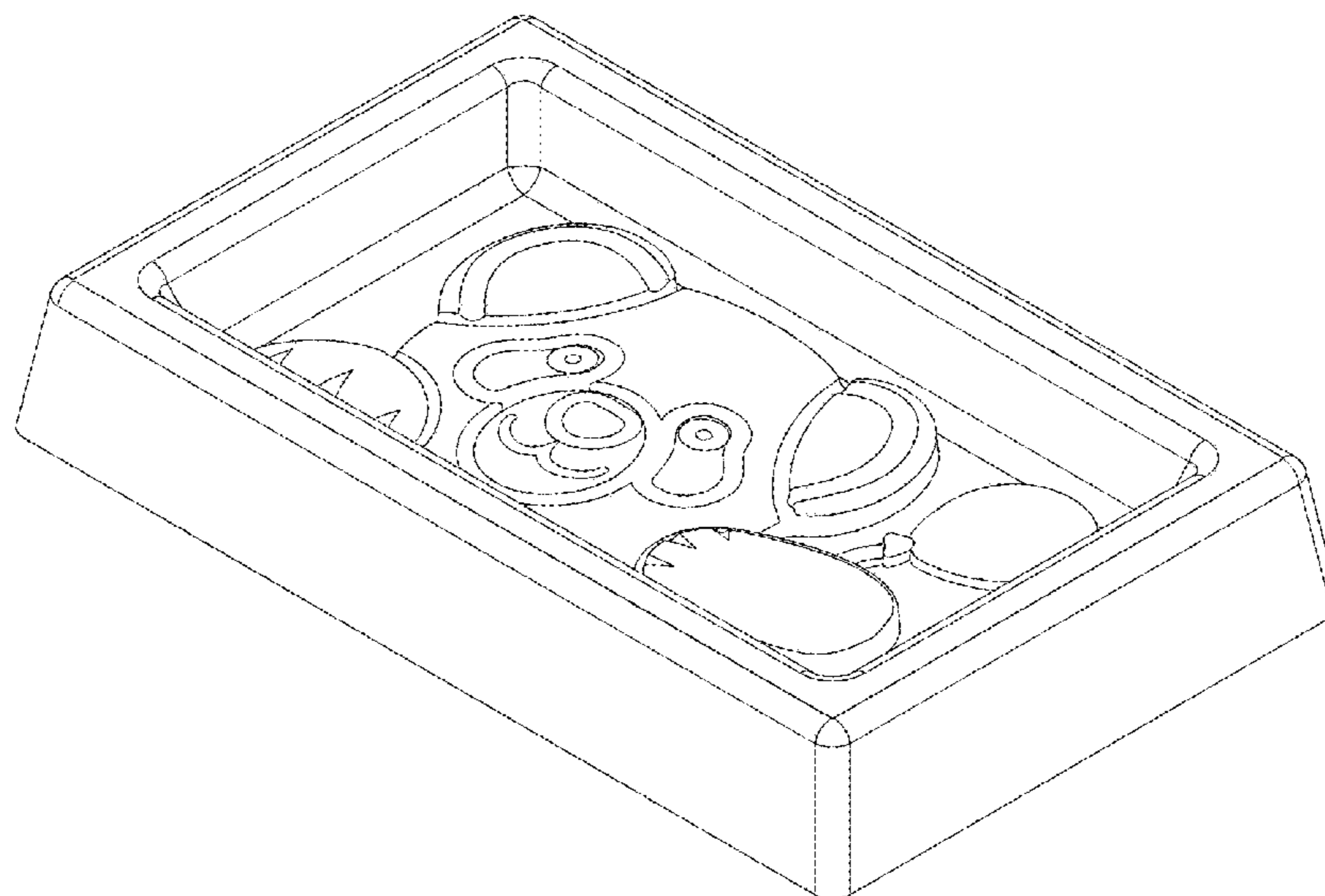

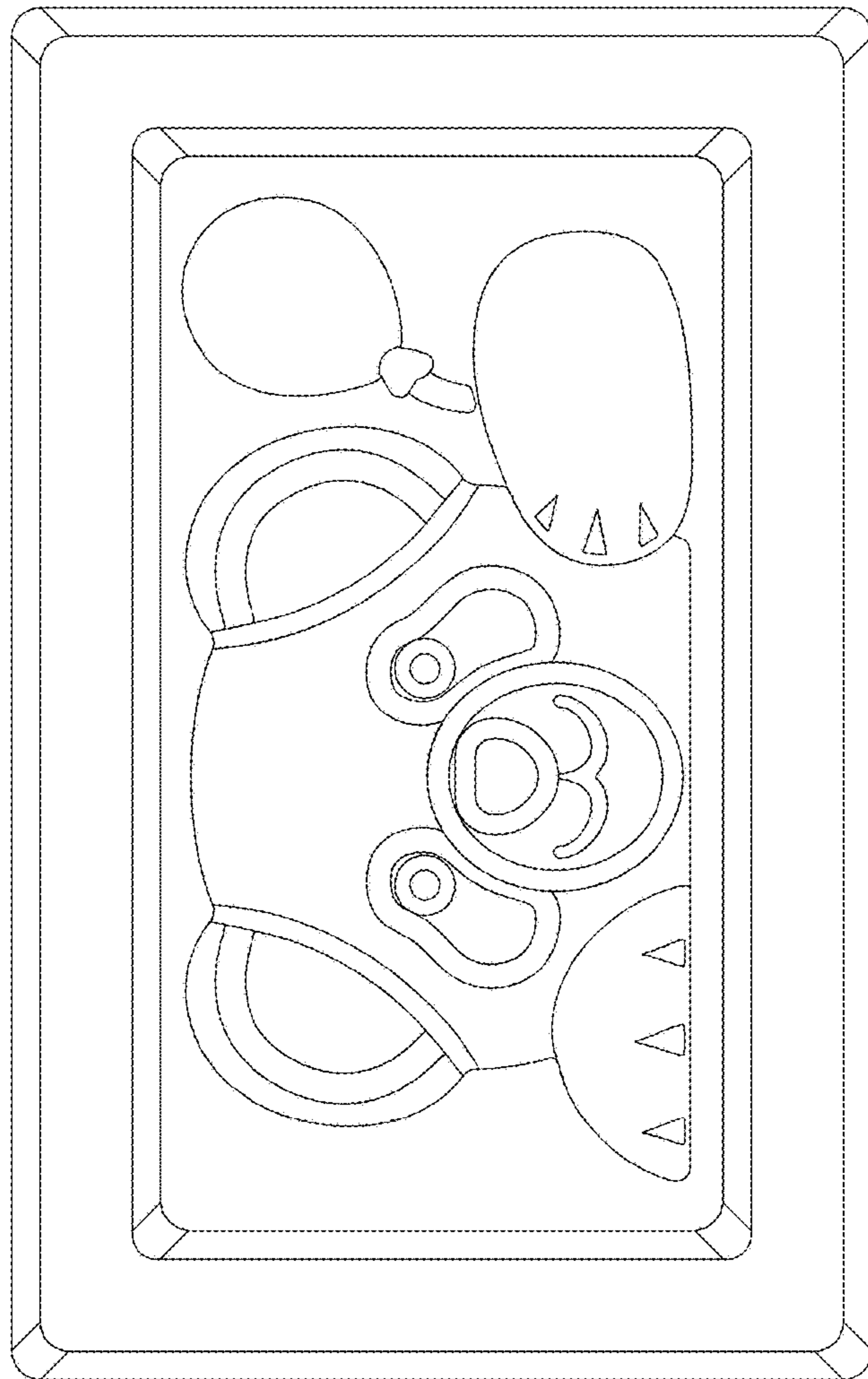

FIG. 1

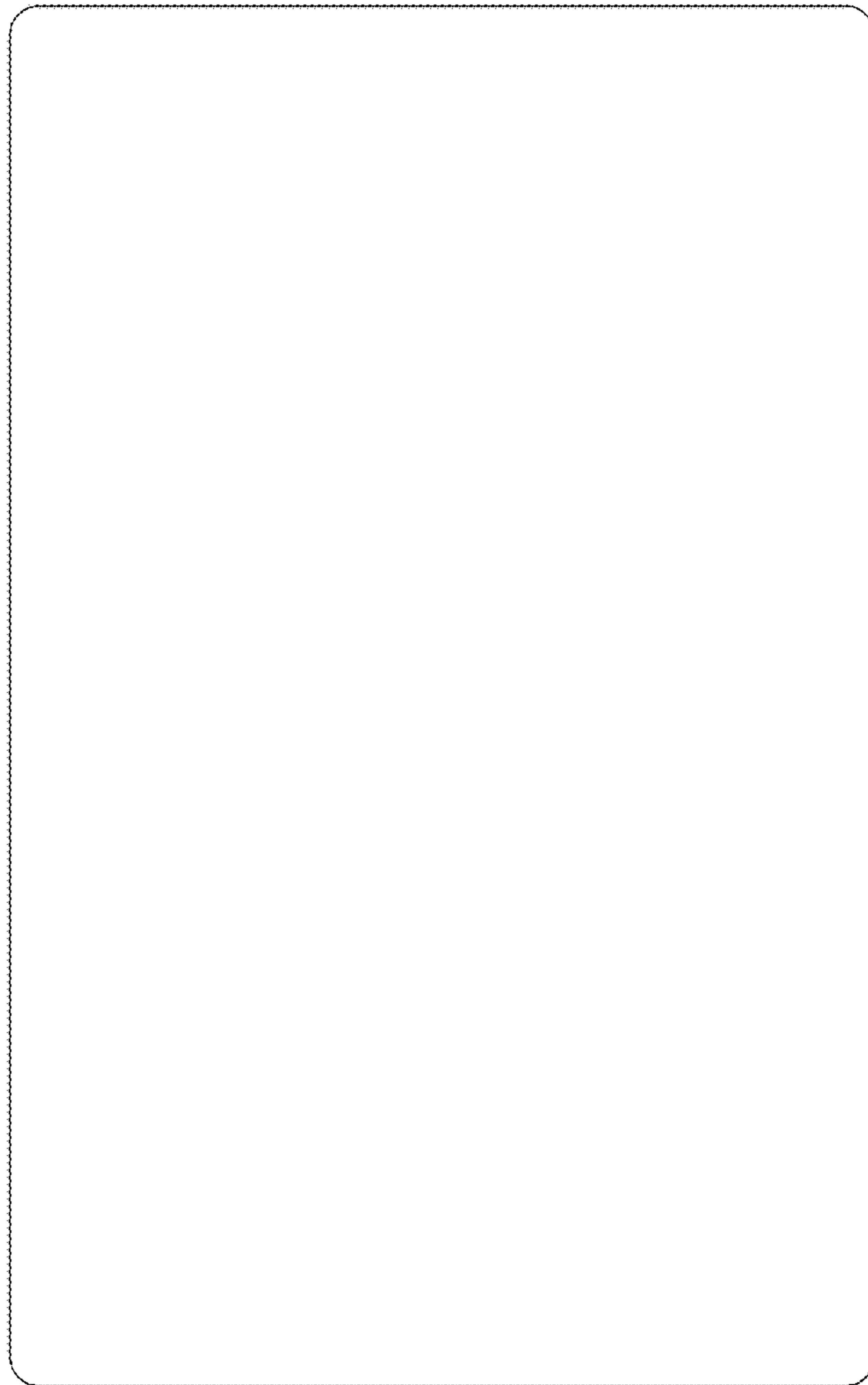

FIG. 2

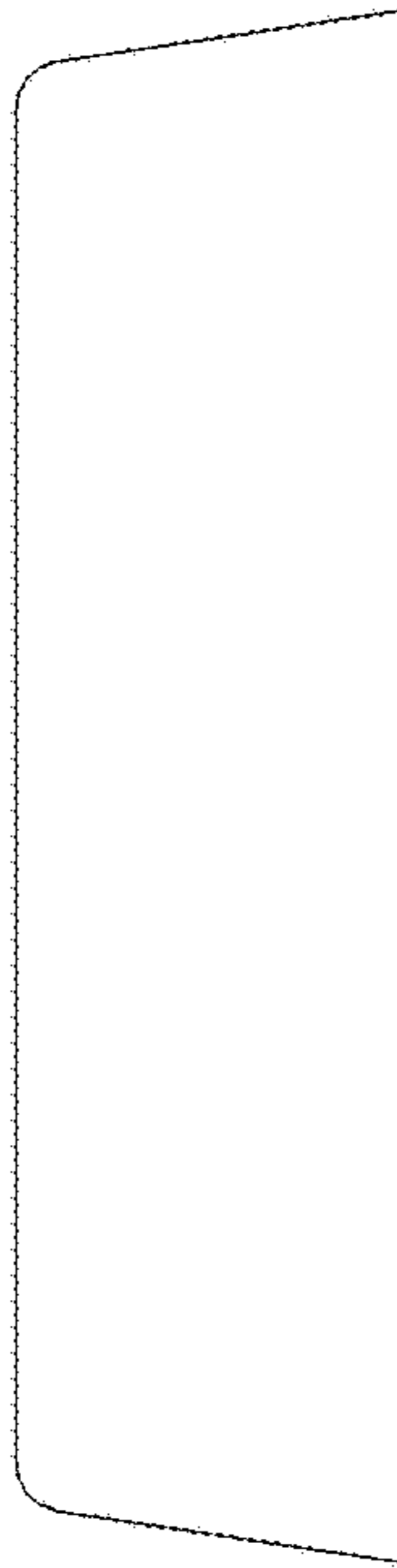

FIG. 3

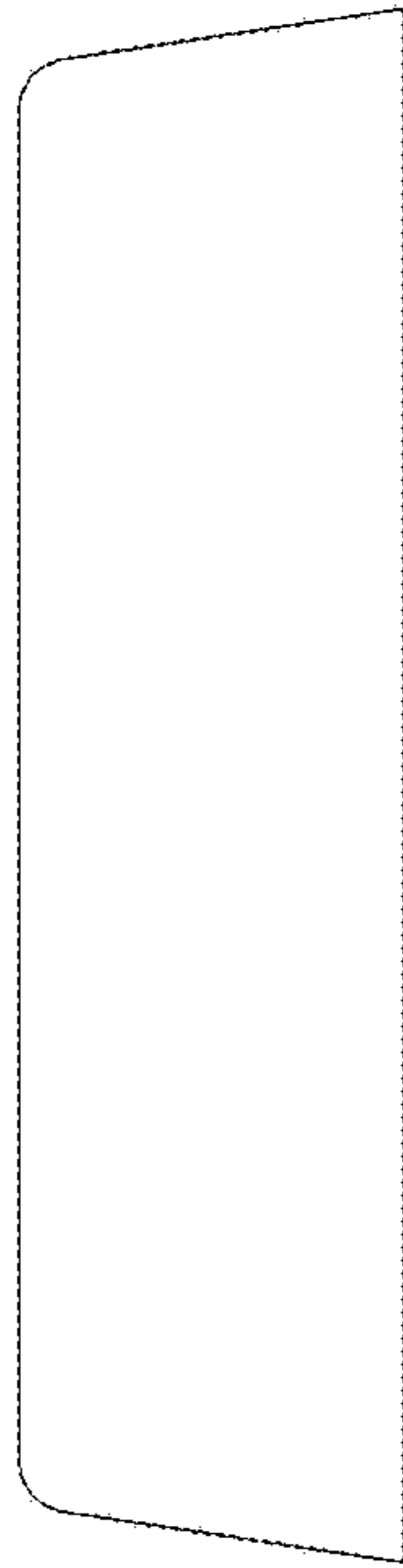

FIG. 4

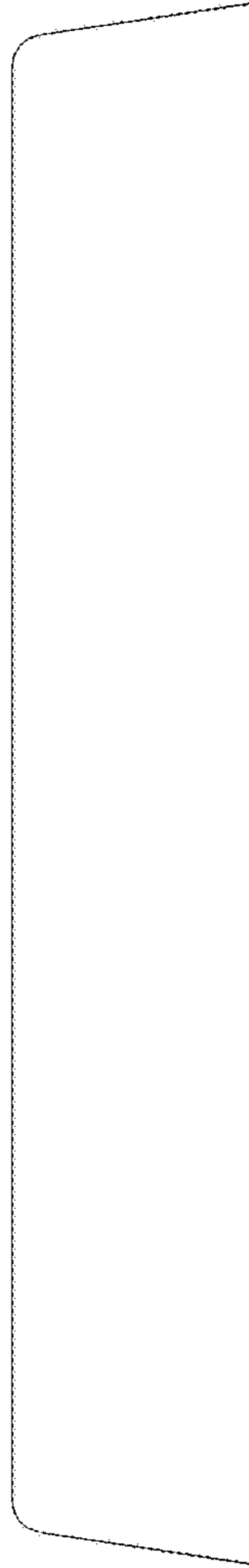

FIG. 5

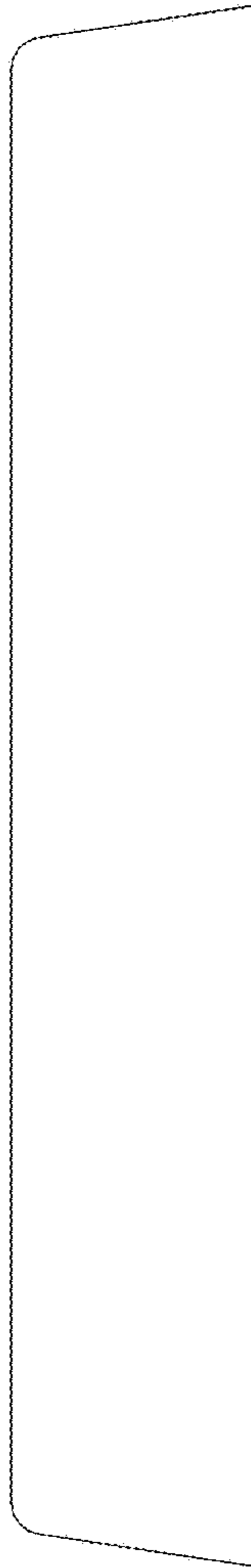

FIG. 6

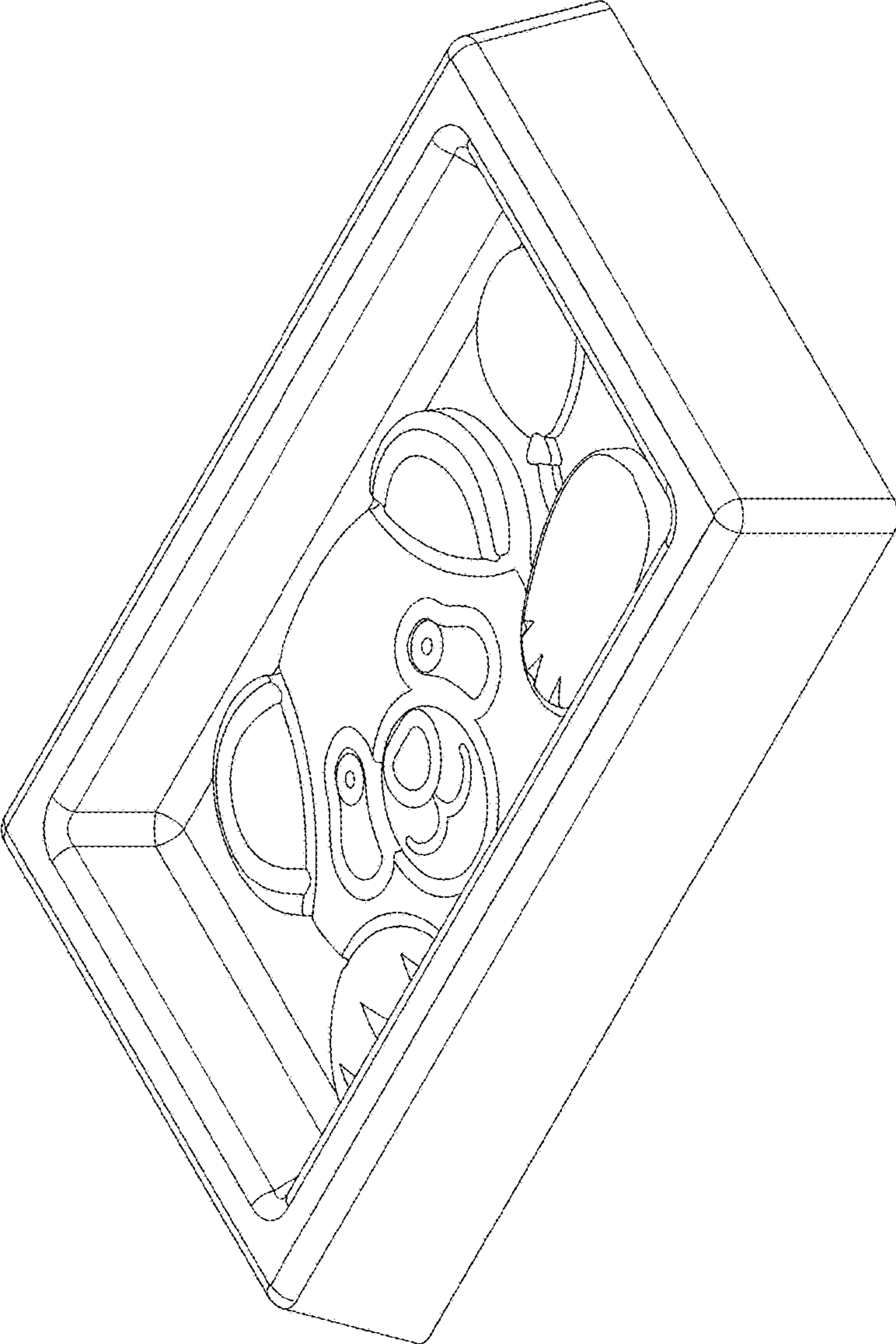

FIG. 7