



US00D839518S

(12) **United States Design Patent**  
**Nam et al.**

(10) **Patent No.:** **US D839,518 S**  
(45) **Date of Patent:** **\*\* Jan. 29, 2019**

(54) **SUCTION NOZZLE FOR VACUUM CLEANER**

(71) Applicant: **LG ELECTRONICS INC.**, Seoul (KR)

(72) Inventors: **Bohyun Nam**, Seoul (KR); **Jaeyoung Kim**, Seoul (KR); **Myungwhoon Lee**, Seoul (KR)

(73) Assignee: **LG ELECTRONICS INC.**, Seoul (KR)

(\*\*) Term: **15 Years**

(21) Appl. No.: **35/502,781**

(22) Filed: **Oct. 14, 2016**

(80) **Hague Agreement Data**

Int. Filing Date: **Oct. 14, 2016**

Int. Reg. No.: **DM/093071**

Int. Reg. Date: **Oct. 14, 2016**

Int. Reg. Pub. Date: **Apr. 14, 2017**

(30) **Foreign Application Priority Data**

May 31, 2016 (KR) ..... 30-2016-0026400

(51) **LOC (11) Cl.** ..... **15-05**

(52) **U.S. Cl.**  
USPC ..... **D32/32**

(58) **Field of Classification Search**

USPC .... D32/17-18, 21-22, 31-32, 34, 69-70, 72

CPC ..... A47L 5/24; A47L 5/38; A47L 5/28; A47L

11/4044; A47L 11/34; A47L 7/0038;

A47L 9/325; A47L 9/02; A47L 1/08;

D01H 11/006; B60S 1/64; A46B 11/001;

A46B 11/002; B08B 3/026; B08B 3/028

See application file for complete search history.

(56) **References Cited**

U.S. PATENT DOCUMENTS

D524,498 S *	7/2006	Luebbering .....	D32/32
D541,499 S *	4/2007	Proud .....	D32/32
D575,467 S *	8/2008	Paredes .....	D32/32
D621,564 S *	8/2010	Kaffenberger .....	D32/32
D643,168 S *	8/2011	Dyson .....	D32/32
D649,725 S *	11/2011	Fjellman .....	D32/32
D738,583 S *	9/2015	Gidwell .....	D32/25
D752,301 S *	3/2016	Courtney .....	D32/32
D752,302 S *	3/2016	Courtney .....	D32/32
D787,766 S *	5/2017	Nam .....	D32/32
D807,603 S *	1/2018	Roschi .....	D32/32

\* cited by examiner

*Primary Examiner* — Michael A. Pratt

(74) *Attorney, Agent, or Firm* — Birch, Stewart, Kolasch & Birch, LLP

(57) **CLAIM**

The ornamental design for a suction nozzle for vacuum cleaner, as shown and described.

**DESCRIPTION**

1. Suction nozzle for vacuum cleaner

**1.1** is a perspective view of a suction nozzle for vacuum cleaner, showing our new design;

**1.2** is a front elevation view thereof;

**1.3** is a rear elevation view thereof;

**1.4** is a left-side elevation view thereof;

**1.5** is a right-side elevation view thereof;

**1.6** is a top plan view thereof; and

**1.7** is a bottom plan view thereof.

The broken line shown in figures **1.1** through **1.6** is for the purpose of illustrating portions that do not form a part of the claimed design.

**1 Claim, 7 Drawing Sheets**

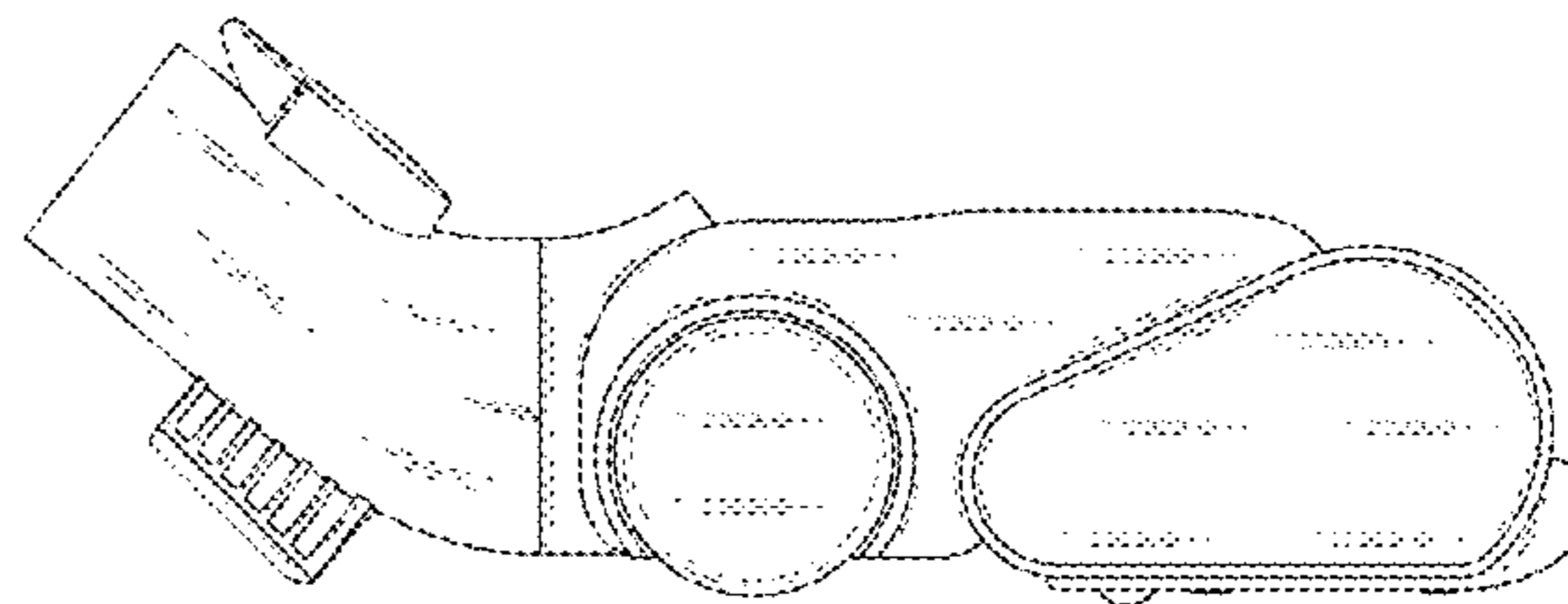
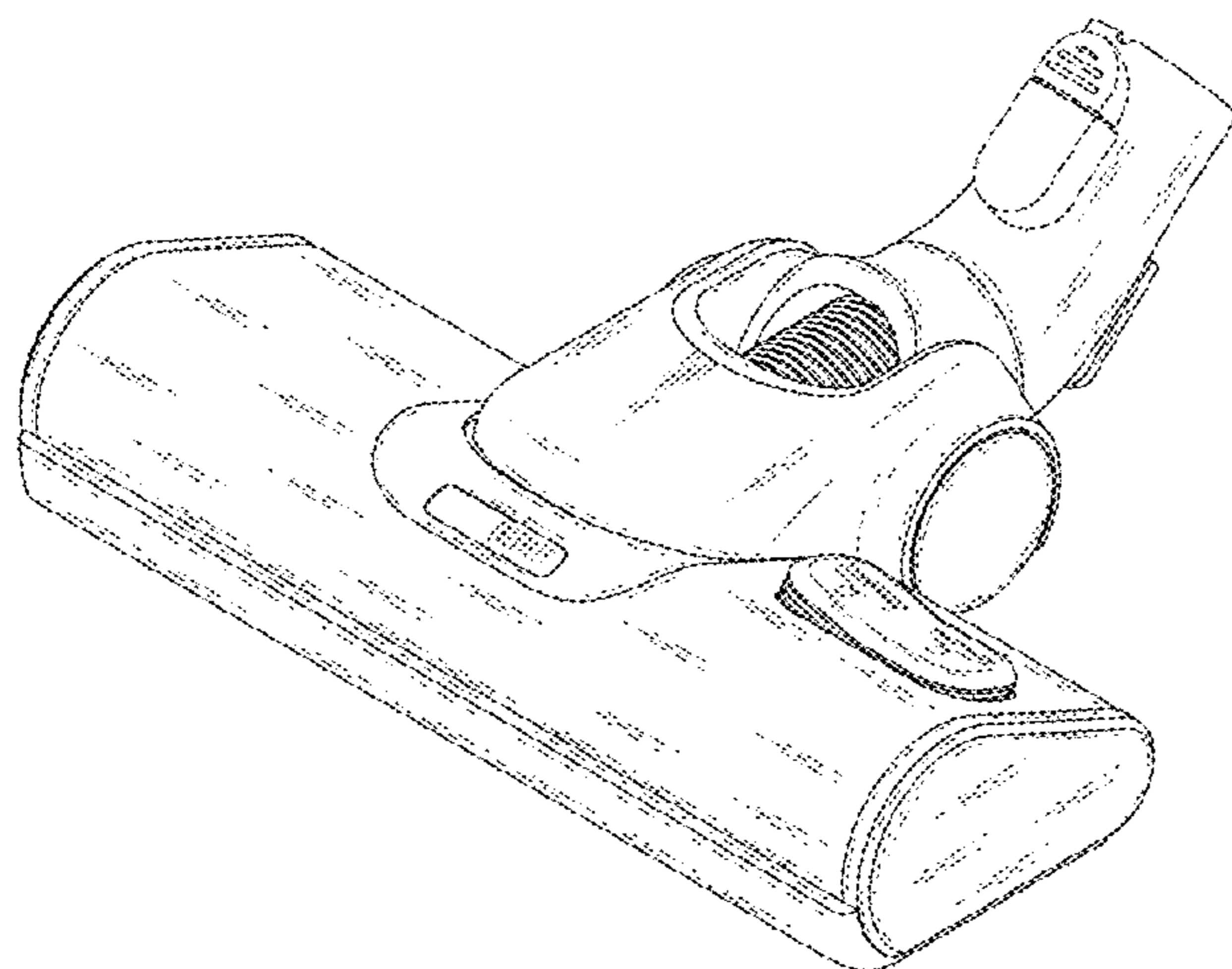

1.1

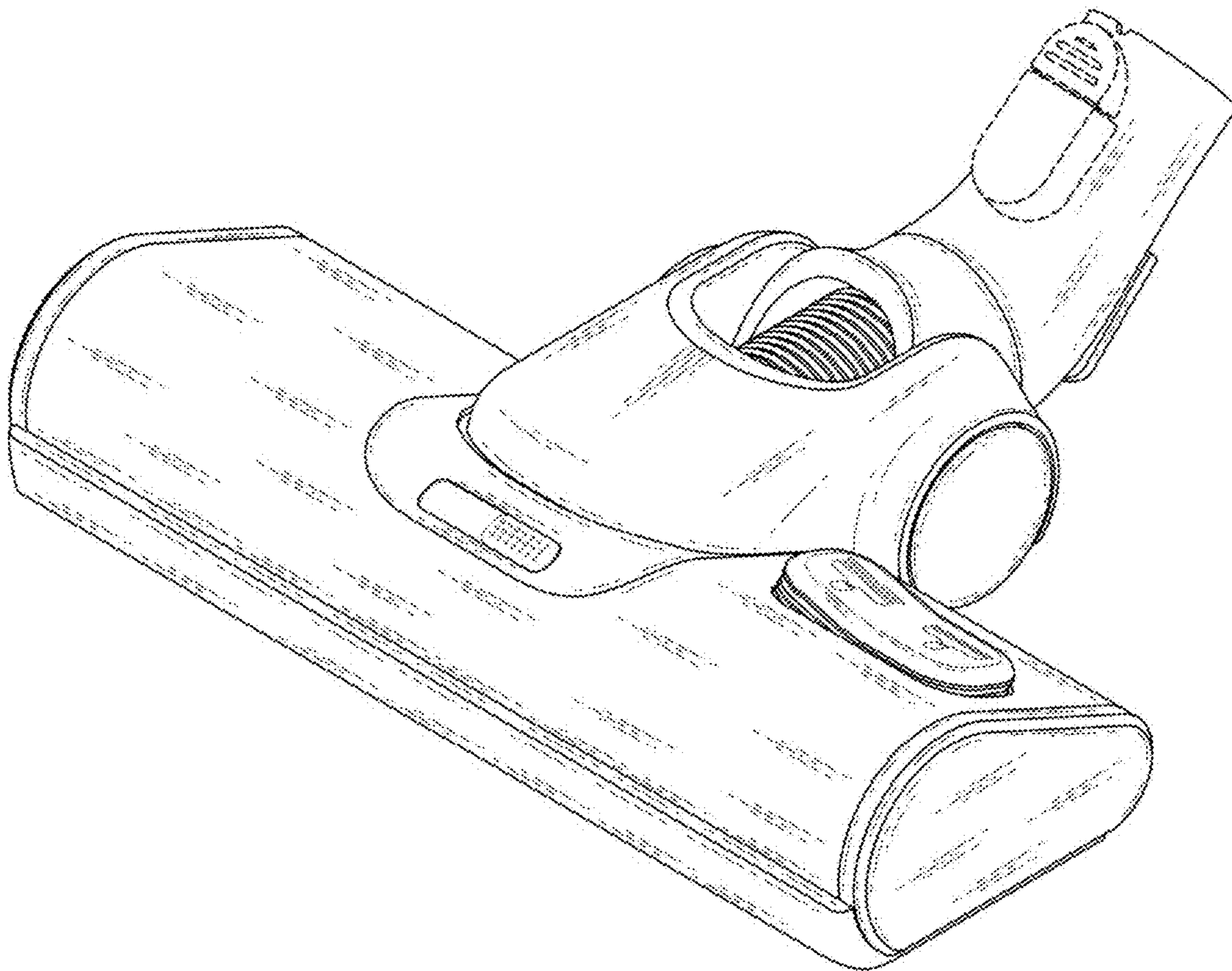

1.2

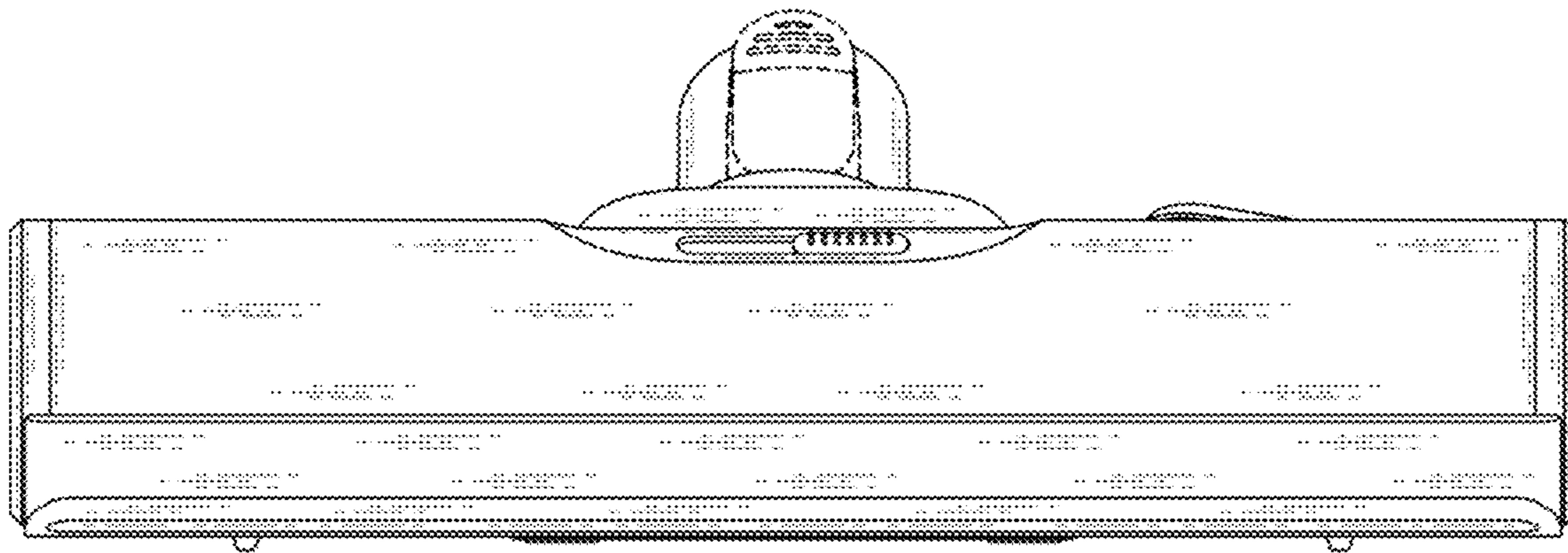

1.3

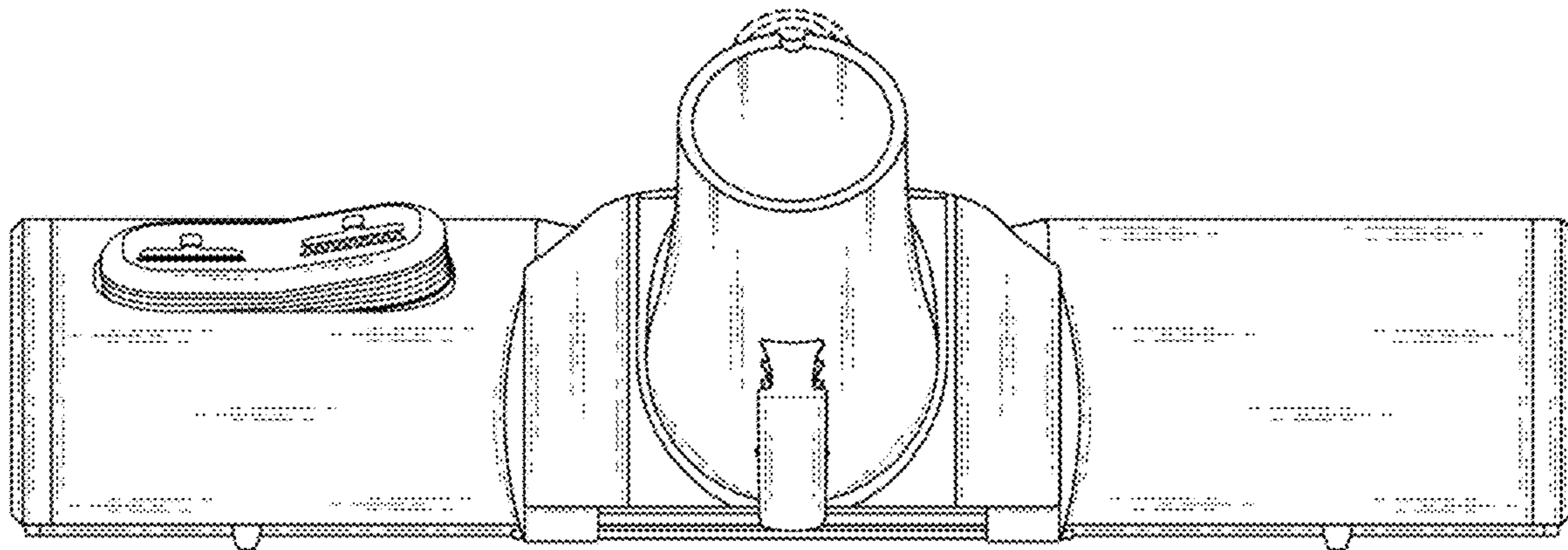



1.4

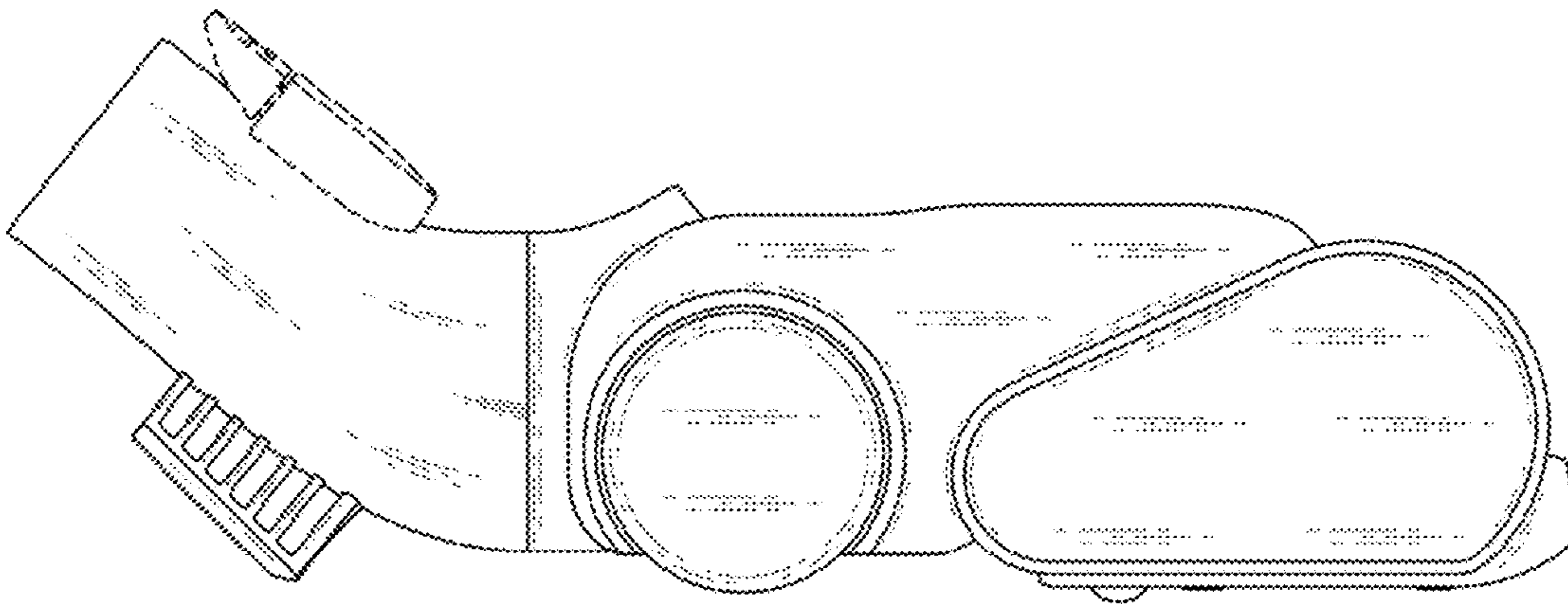

1.5

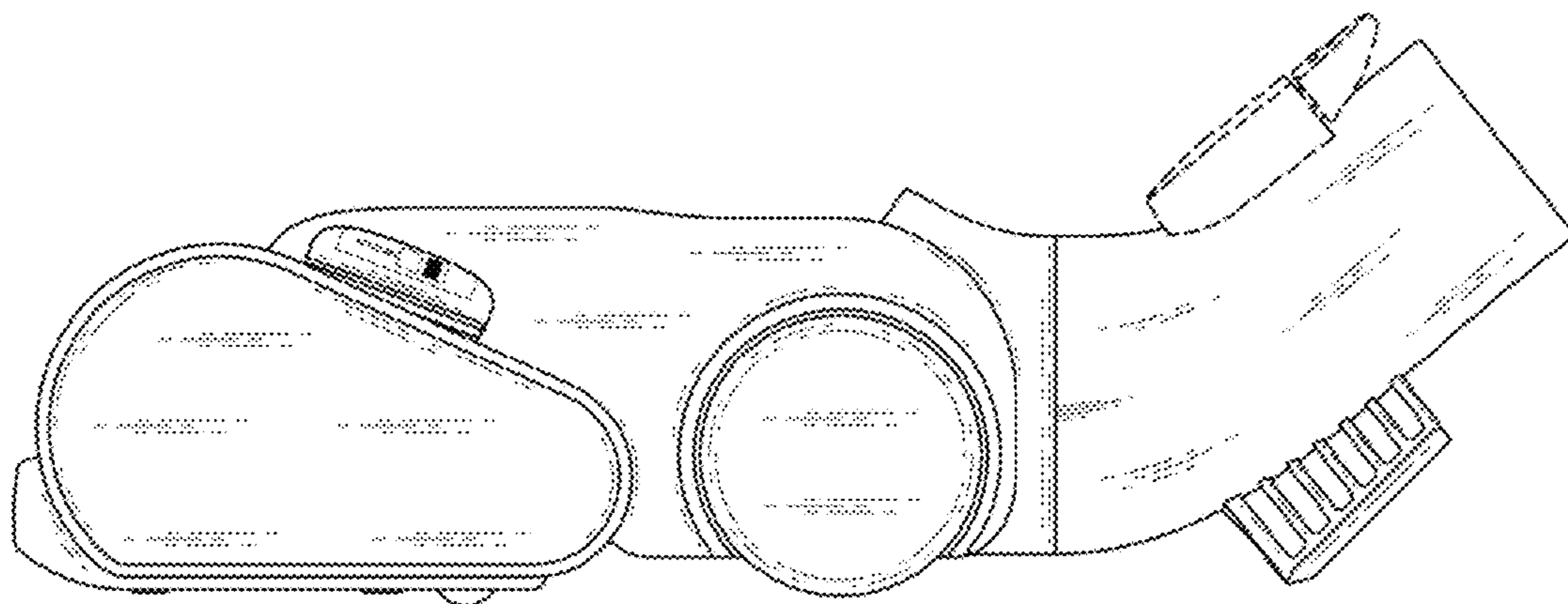

1.6

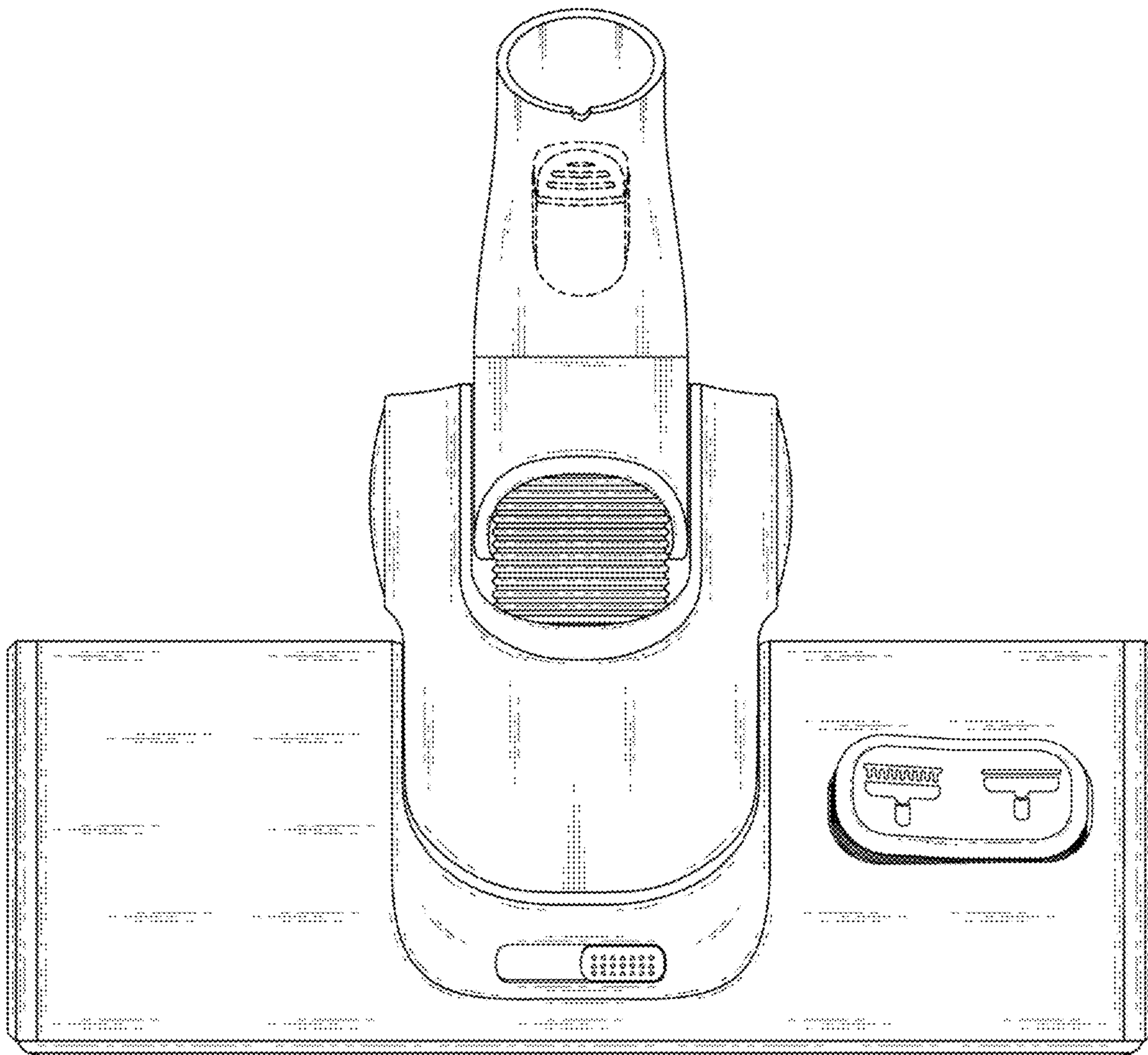

1.7

