



US00D839412S

(12) **United States Design Patent** (10) **Patent No.:** **US D839,412 S**
Wohlfahrt et al. (45) **Date of Patent:** **** *Jan. 29, 2019**

(54) **AUTO-INJECTOR**

A61M 5/14248; A61M 2005/14513;
A61M 2005/206

(71) Applicant: **Novartis AG**, Basel (CH)

See application file for complete search history.

(72) Inventors: **Tobias Wohlfahrt**, München (DE);
Samuel Coendet, München (DE);
Johannes Egger, München (DE);
Gabriel Iobbi, Basel (CH); **Alain Schmidlin**, Basel (CH); **Mads Sabra**, Basel (CH); **Agathe Buffard**, Basel (CH); **Muriel Didier**, Basel (CH); **Erich Studer**, Basel (CH); **Andrew Bryant**, Basel (CH)

(56) **References Cited**

U.S. PATENT DOCUMENTS

D269,249 S	6/1983	Cillario	
D281,827 S	12/1985	Bakic	
D496,585 S	9/2004	McBride et al.	
D507,968 S *	8/2005	Dixon	D9/422
7,455,663 B2	11/2008	Bikovskiy	
D588,908 S	3/2009	Silvenis et al.	
D592,494 S	5/2009	Wichowski	
D602,155 S *	10/2009	Foley	D24/113
D602,586 S *	10/2009	Foley	D24/113
D612,042 S	3/2010	Noren	
D631,552 S	1/2011	Kasabach et al.	
D640,131 S	6/2011	Gibson et al.	
8,157,769 B2 *	4/2012	Cabiri	A61M 5/14248 604/131
D664,298 S	7/2012	Grabes et al.	
8,323,213 B2 *	12/2012	Kim	A61B 5/412 4/144.1

(73) Assignee: **Novartis AG**, Basel (CH)

(*) Notice: This patent is subject to a terminal disclaimer.

(**) Term: **15 Years**

(Continued)

(21) Appl. No.: **29/607,609**

Primary Examiner — David G Muller

Assistant Examiner — Nathan M Johnston

(22) Filed: **Jun. 14, 2017**

(74) *Attorney, Agent, or Firm* — Mintz Levin Cohn Ferris Glovsky and Popeo, P.C.

(30) **Foreign Application Priority Data**

Dec. 15, 2016 (EM) 003518943

(51) **LOC (11) Cl.** **24-02**

(52) **U.S. Cl.**
USPC **D24/112**

(58) **Field of Classification Search**
USPC D24/112-114, 133, 186, 104, 130, 127,
D24/176, 108, 110, 220; 606/181, 185;
604/232, 187, 158, 164.08, 192, 263, 163,
604/181, 184, 198, 227, 168.01, 275,
604/890.1; D9/414, 424, 417, 426
CPC A61M 2005/14252; A61M 2005/1581;

(57) **CLAIM**

The ornamental design for an auto-injector, as shown and described.

DESCRIPTION

FIG. 1 is a top, right side, front perspective view of an auto-injector showing our new design; FIG. 2 is a front elevation view thereof; FIG. 3 is a rear elevation view thereof; FIG. 4 is a left side elevation view thereof; FIG. 5 is a right side elevation view thereof; FIG. 6 is a top plan view thereof; and, FIG. 7 is a bottom plan view thereof.

(Continued)

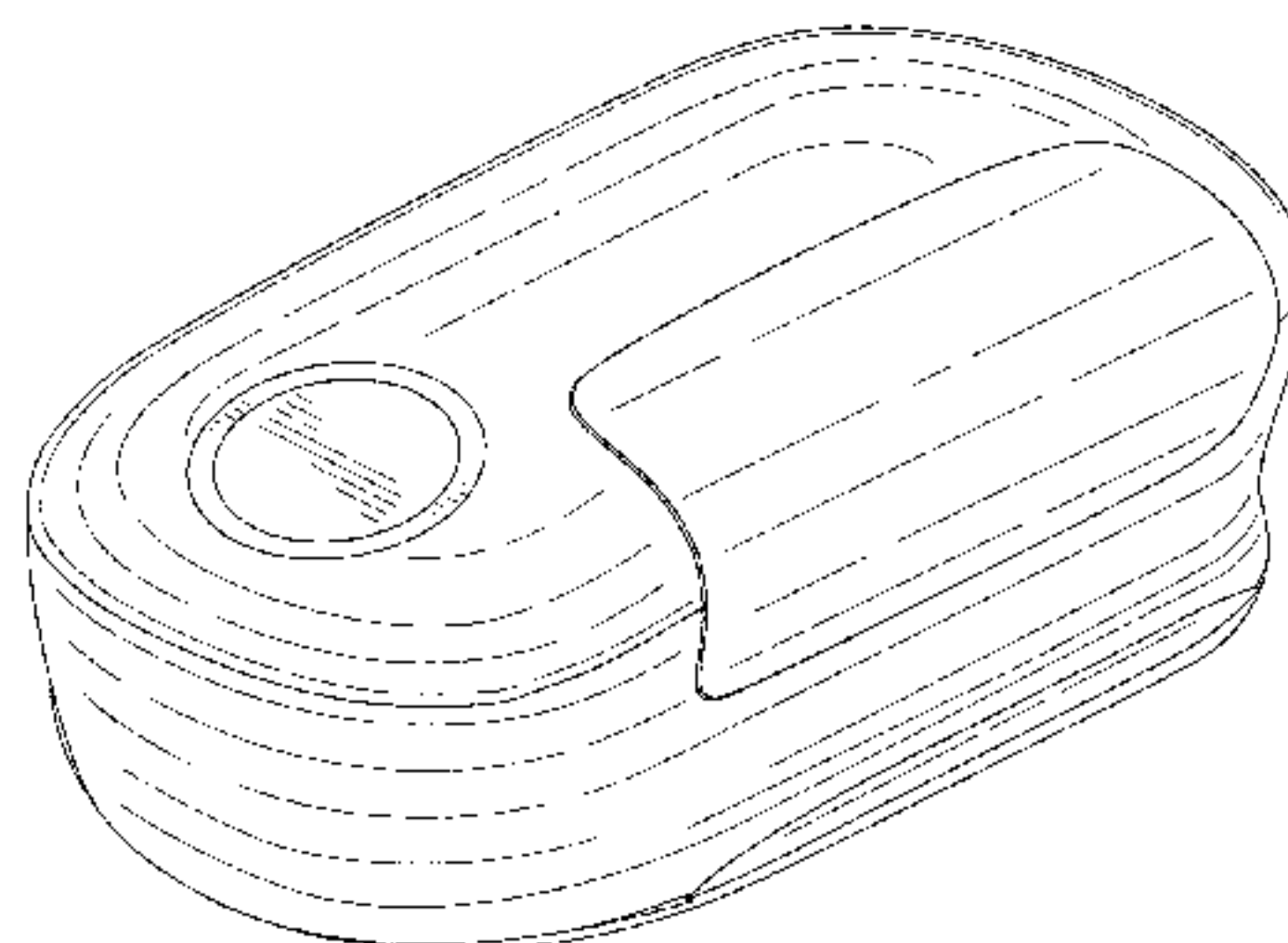

The dash-dash broken lines illustrate portions of the auto-injector that form no part of the claimed design.

1 Claim, 7 Drawing Sheets

(56)

References Cited

U.S. PATENT DOCUMENTS

8,381,909 B2 2/2013 Hernandez et al.
 D683,844 S 6/2013 Andrade et al.
 D685,083 S * 6/2013 Schneider D24/108
 D687,141 S * 7/2013 Schneider D24/108
 D687,536 S * 8/2013 Guarraia D24/108
 D694,102 S 11/2013 Bellamah et al.
 D699,855 S * 2/2014 Netzel D24/188
 D733,288 S 6/2015 Althorpe et al.
 D744,109 S 11/2015 Yoneta et al.
 D744,110 S 11/2015 Kubo et al.
 D748,273 S * 1/2016 Chang D24/186
 D759,236 S * 6/2016 Preiss D24/127
 D760,374 S 6/2016 Nagar et al.
 D769,438 S * 10/2016 Crosby D24/110
 D774,640 S * 12/2016 Tyce D24/113
 D776,270 S 1/2017 Wilcox et al.
 D776,873 S * 1/2017 Levi D24/133
 9,707,335 B2 * 7/2017 Agard A61M 5/14216
 D794,770 S * 8/2017 Wu D24/108
 9,782,545 B2 * 10/2017 Gross A61M 5/31596
 D804,015 S * 11/2017 Lamba D24/110
 D804,019 S * 11/2017 Costello D24/113
 D804,042 S * 11/2017 Cohrs D24/186
 D805,190 S 12/2017 Costello et al.
 D805,633 S 12/2017 Costello et al.

D806,232 S * 12/2017 Hwang D24/112
 D806,234 S * 12/2017 Costello D24/113
 D806,880 S 1/2018 Henning
 2008/0281270 A1 * 11/2008 Cross A61M 5/1413
 604/122
 2009/0216194 A1 8/2009 Elgard Pedersen et al.
 2010/0114026 A1 * 5/2010 Karratt A61M 5/14248
 604/151
 2012/0078181 A1 * 3/2012 Smith A61M 5/14216
 604/152
 2014/0058349 A1 * 2/2014 Bazargan A61M 5/1456
 604/500
 2014/0207065 A1 * 7/2014 Yavorsky A61M 5/14248
 604/151
 2014/0213975 A1 7/2014 Clemente et al.
 2015/0051573 A1 * 2/2015 Tieck A61M 5/14216
 604/500
 2015/0057613 A1 * 2/2015 Clemente A61M 5/14566
 604/148
 2015/0250943 A1 * 9/2015 Momose A61M 5/14276
 604/151
 2015/0306307 A1 * 10/2015 Cole A61M 5/14248
 604/508
 2016/0058941 A1 * 3/2016 Wu A61M 5/145
 604/136
 2016/0317738 A1 * 11/2016 Cross A61M 5/1454
 2016/0369789 A1 * 12/2016 Alderete, Jr. F04B 19/22
 2017/0043101 A1 2/2017 Cole et al.
 2017/0182243 A1 * 6/2017 Cole A61M 5/158
 2017/0224910 A1 * 8/2017 Yodfat A61M 5/1413
 2017/0224915 A1 * 8/2017 Destefano A61M 5/158
 2017/0281864 A1 10/2017 Searle et al.
 2017/0290975 A1 * 10/2017 Barmaimon A61M 5/1454
 2018/0021508 A1 * 1/2018 Destefano A61M 5/14248

* cited by examiner

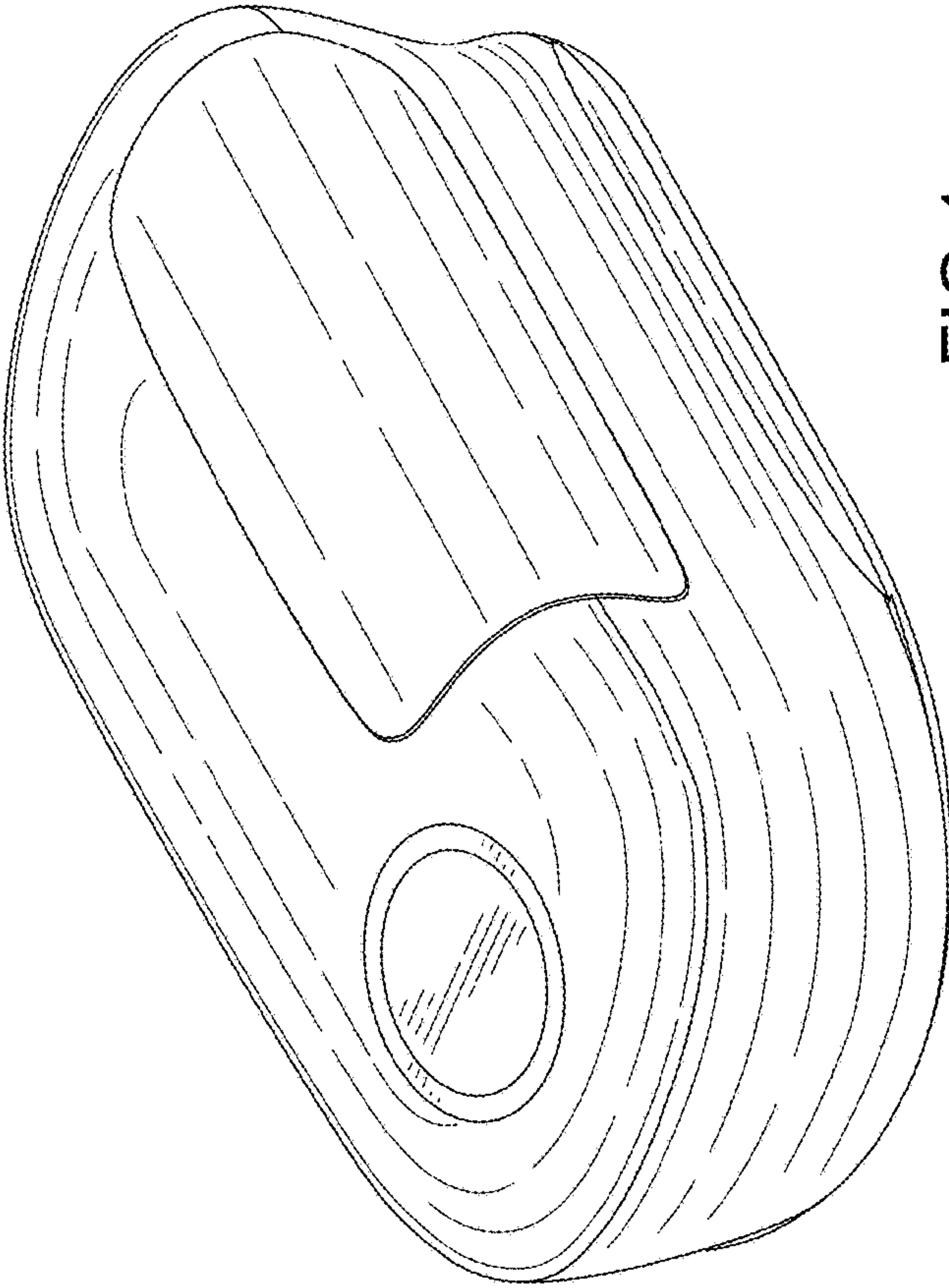

FIG.1

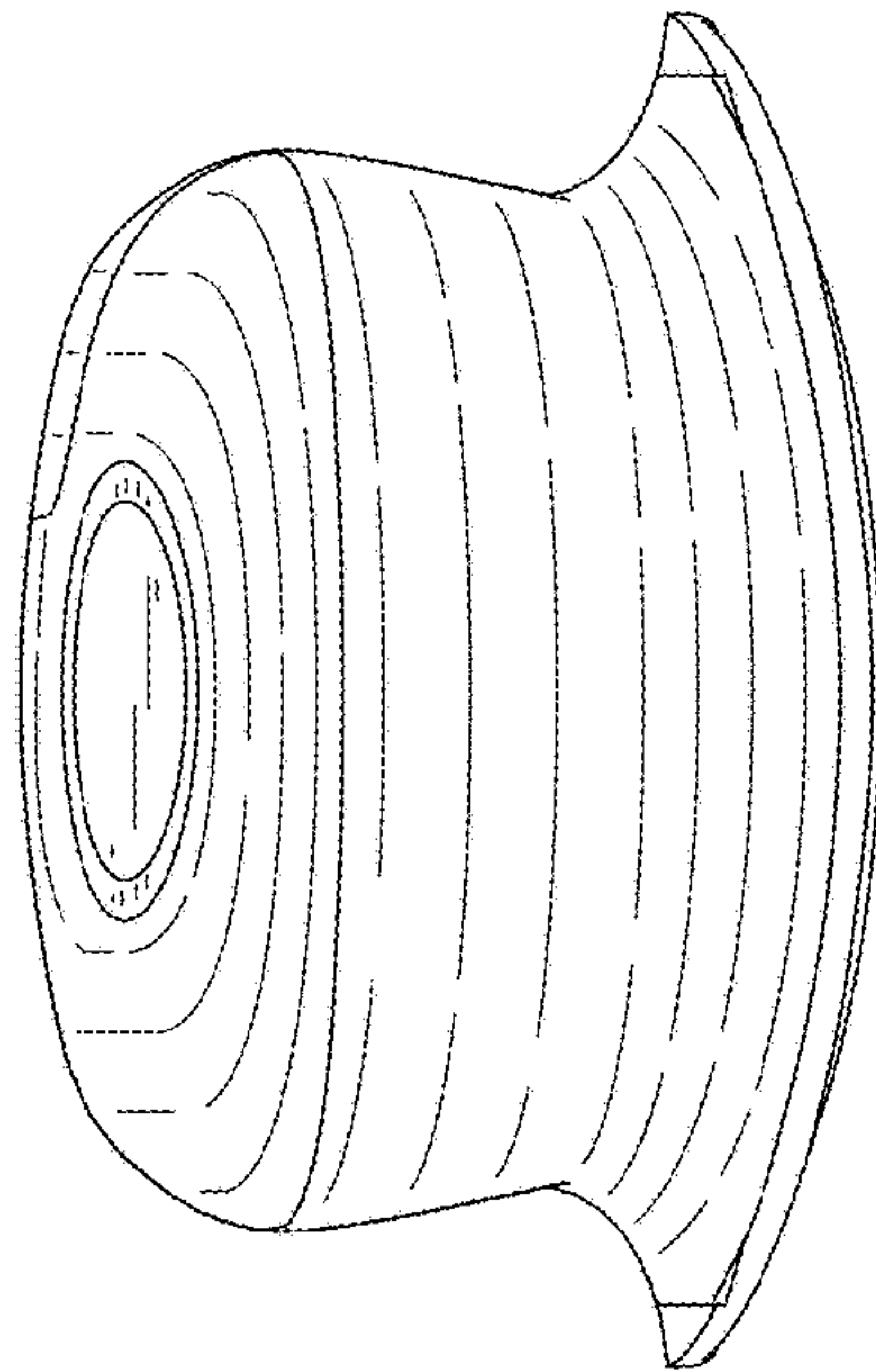

FIG.2

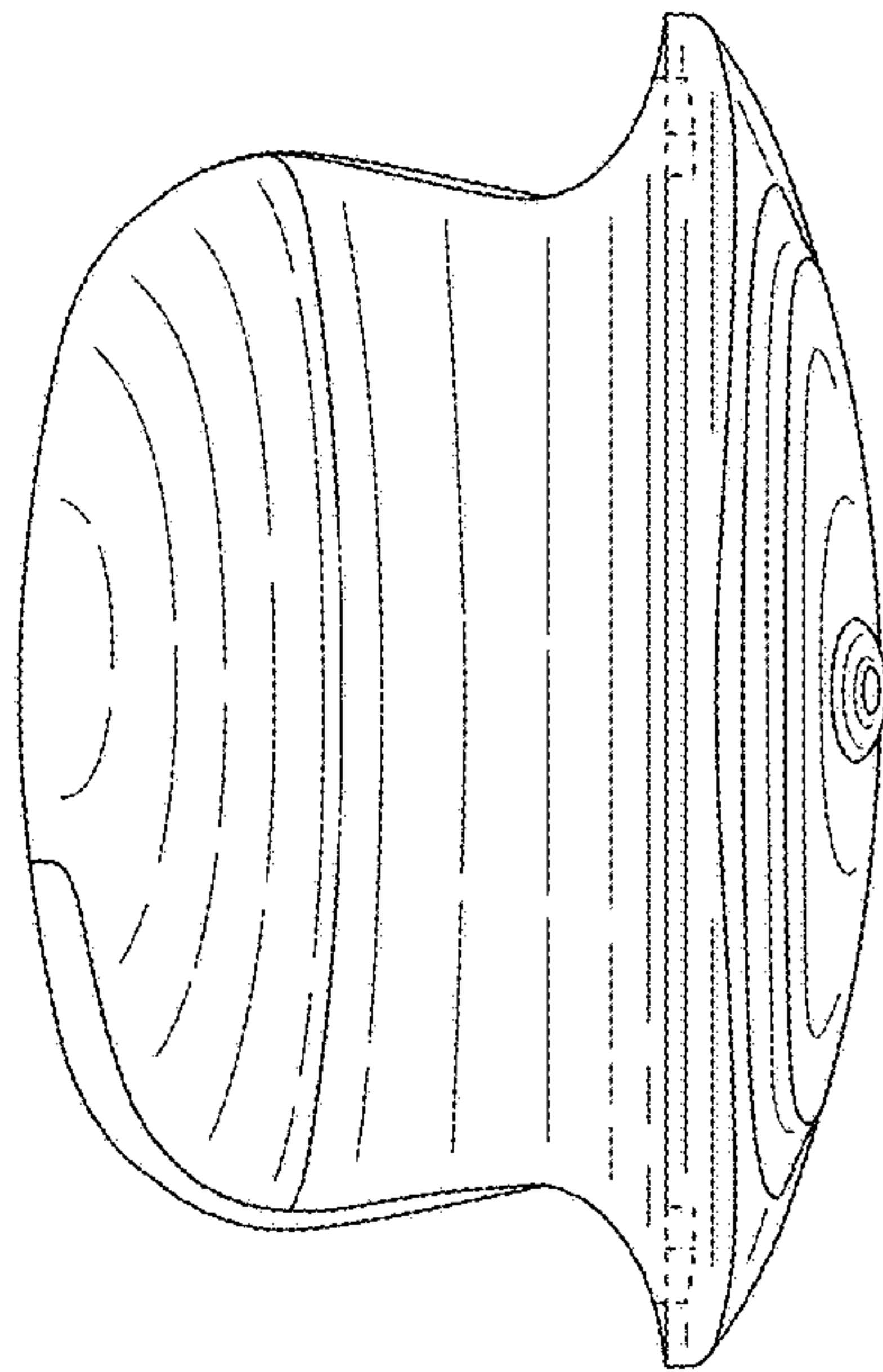

FIG.3

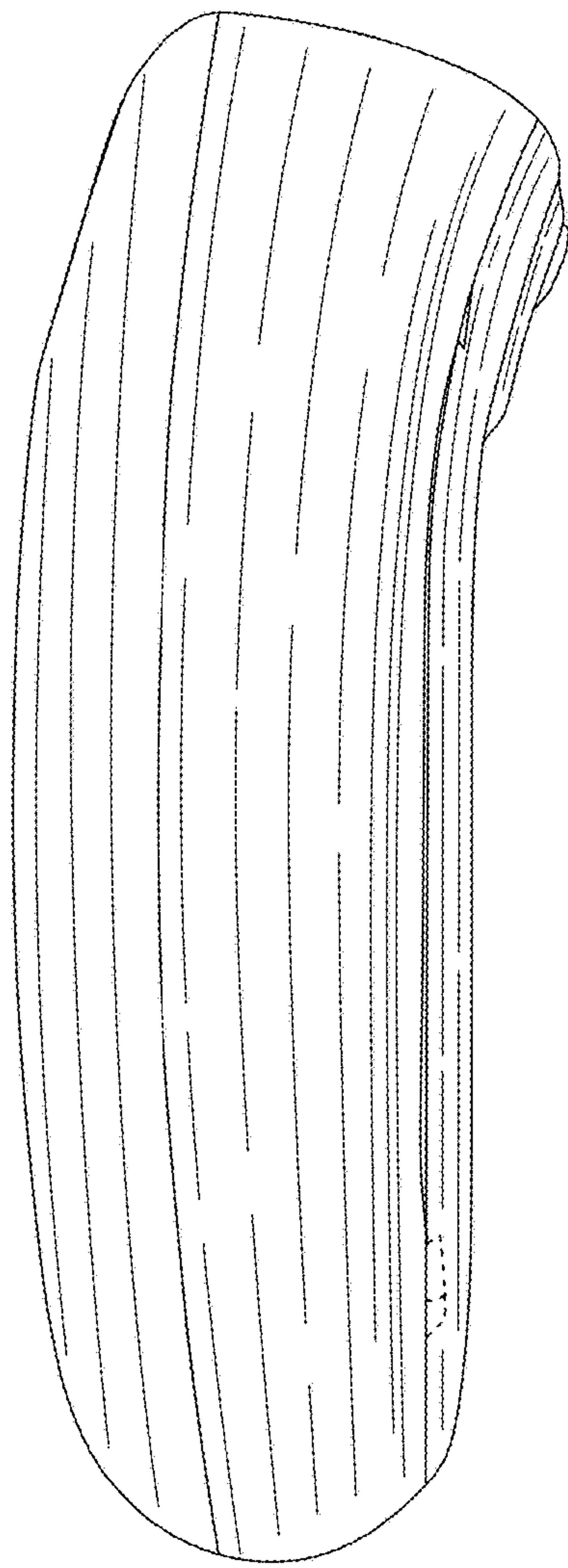

FIG.4

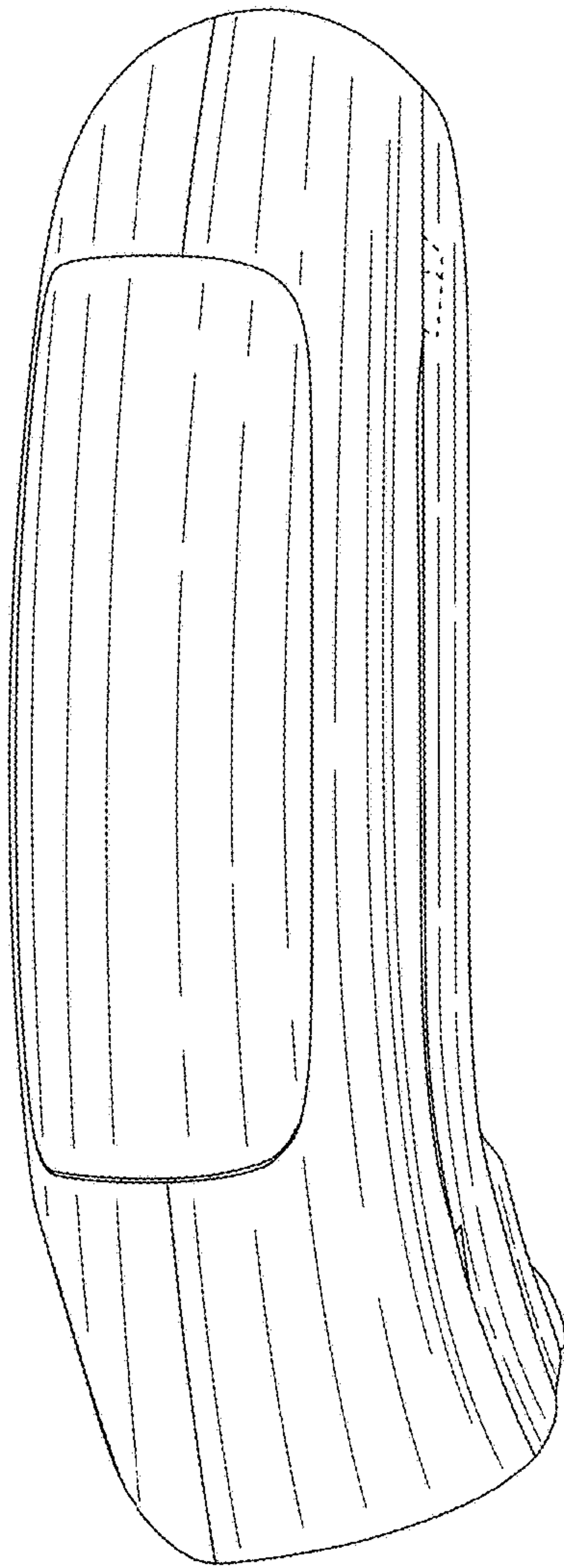

FIG.5

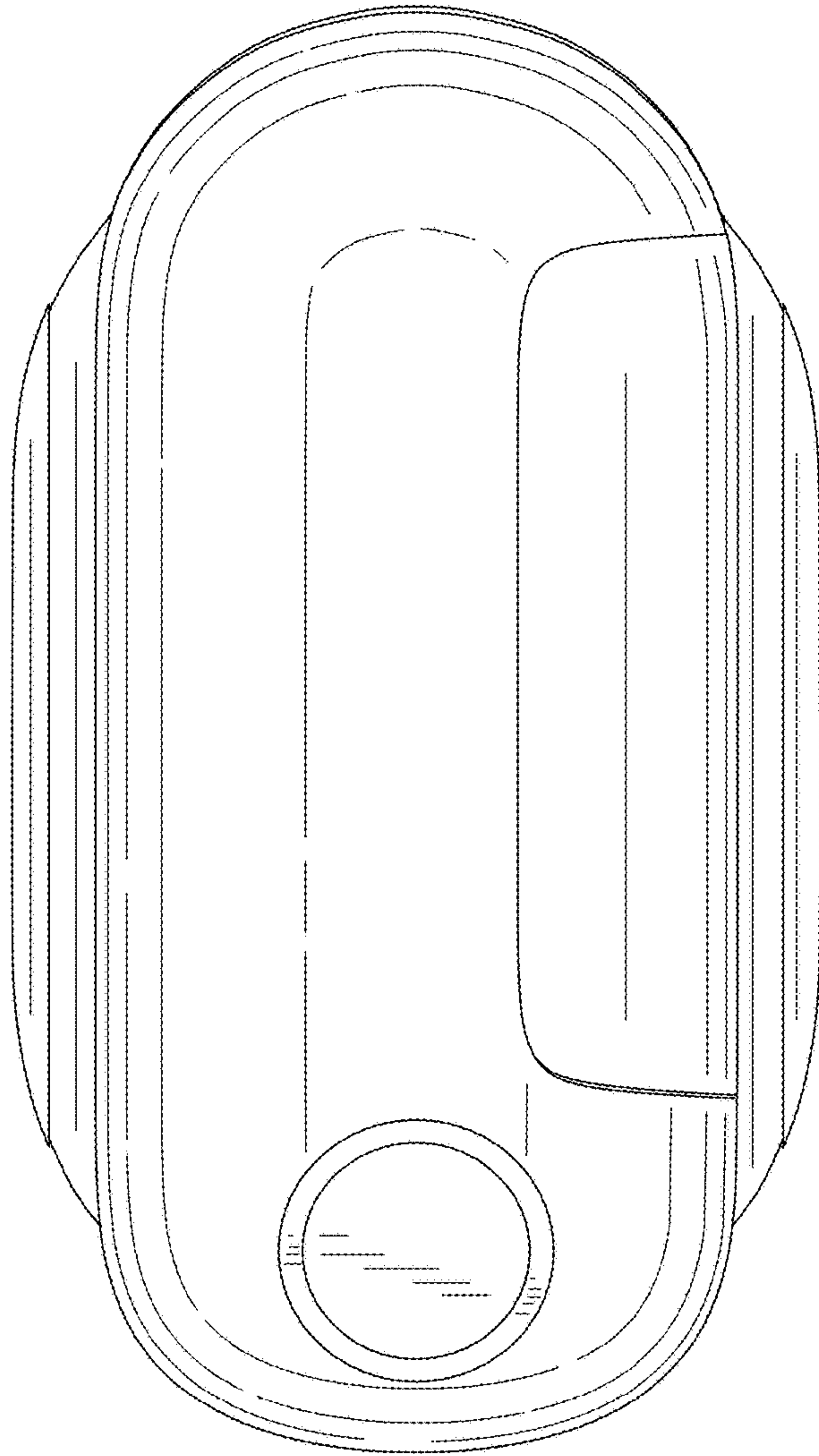

FIG.6

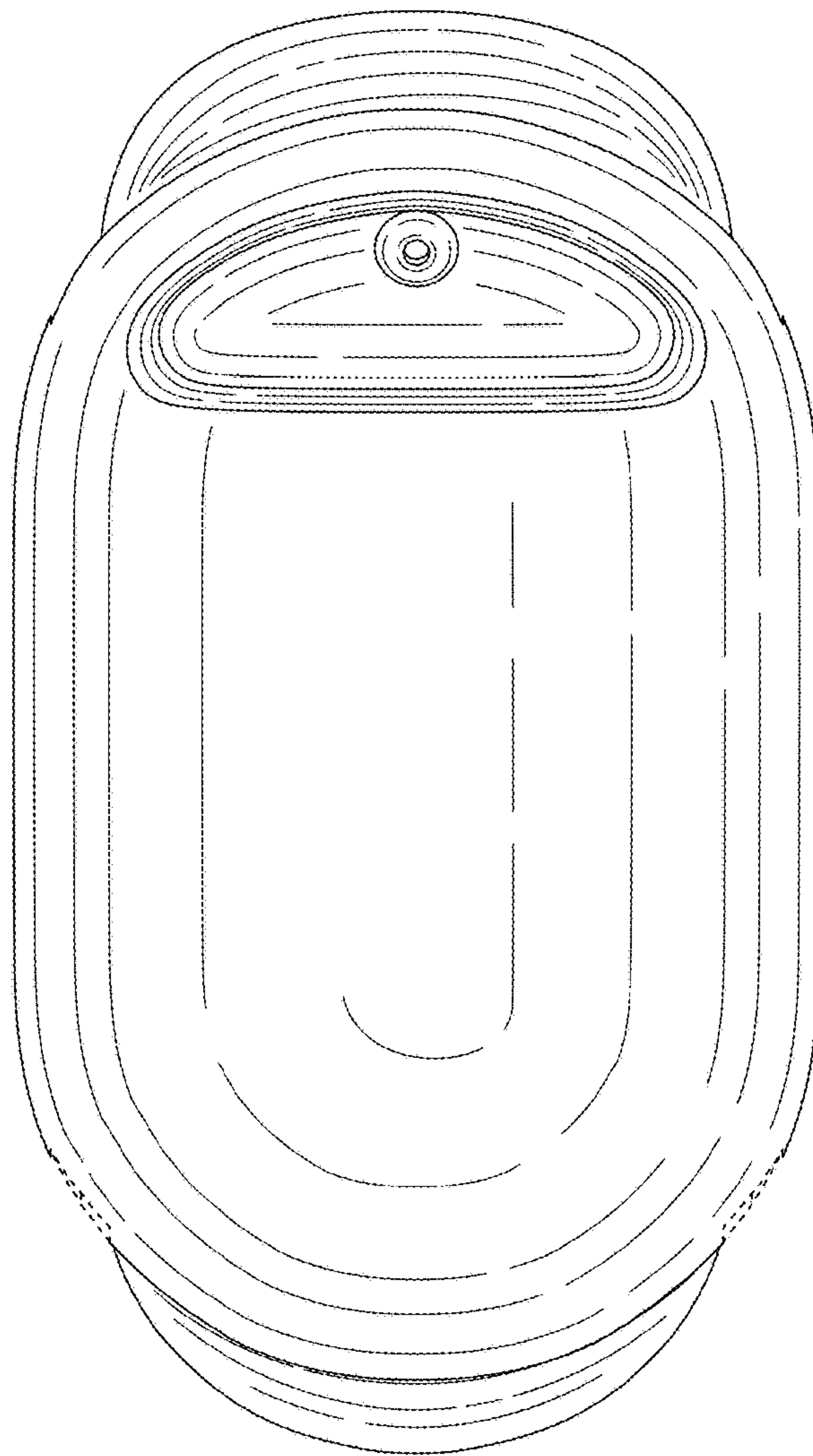

FIG.7