



US00D839411S

(12) **United States Design Patent** (10) **Patent No.:** **US D839,411 S**  
**Wohlfahrt et al.** (45) **Date of Patent:** **\*\* Jan. 29, 2019**

(54) **AUTO-INJECTOR** D496,585 S \* 9/2004 McBride ..... D3/294  
 D507,968 S \* 8/2005 Dixon ..... D9/422  
 (71) Applicant: **Novartis AG**, Basel (CH) 7,455,663 B2 \* 11/2008 Bikovsky ..... A61M 5/1413  
 604/181  
 (72) Inventors: **Tobias Wohlfahrt**, München (DE); D588,908 S \* 3/2009 Silvenis ..... D3/203.1  
**Samuel Coendet**, München (DE); D592,494 S \* 5/2009 Wichowski ..... D9/414  
**Johannes Egger**, München (DE); D602,155 S 10/2009 Foley et al.  
**Gabriel Iobbi**, Basel (CH); **Alain** D602,586 S 10/2009 Foley et al.  
**Schmidlin**, Basel (CH); **Mads Sabra**, D612,042 S \* 3/2010 Noren ..... D24/104  
 Basel (CH); **Agathe Buffard**, Basel D631,552 S \* 1/2011 Kasabach ..... D24/186  
 (CH); **Muriel Didier**, Basel (CH); D640,131 S \* 6/2011 Gibson ..... D9/426  
**Erich Studer**, Basel (CH); **Andrew** 8,157,769 B2 4/2012 Cabiri  
**Bryant**, Basel (CH) D664,298 S \* 7/2012 Grabes ..... D24/133  
 8,323,213 B2 12/2012 Kim  
 8,381,909 B2 \* 2/2013 Hernandez ..... B65D 21/0233  
 206/207  
 (73) Assignee: **Novartis AG**, Basel (CH) D683,844 S \* 6/2013 Andrade ..... D24/110  
 D685,083 S 6/2013 Schneider et al.  
 (\*\*) Term: **15 Years** D687,141 S 7/2013 Schneider et al.

(Continued)

(21) Appl. No.: **29/607,607**

(22) Filed: **Jun. 14, 2017**

(30) **Foreign Application Priority Data**

Dec. 15, 2016 (EM) ..... 003518943

(51) **LOC (11) Cl.** ..... **24-02**

(52) **U.S. Cl.**  
USPC ..... **D24/112**

(58) **Field of Classification Search**

USPC ..... D24/112-114, 133, 186, 104, 130, 127,  
D24/176, 108, 110, 220; 606/181, 185;  
604/232, 187, 158, 164.08, 192, 263, 163,  
604/181, 184, 198, 227, 168.01, 275,  
604/890.1; D9/414, 424, 417, 426

CPC ..... A61M 2005/14252; A61M 2005/1581;  
A61M 5/14248; A61M 2005/14513;  
A61M 2005/206

See application file for complete search history.

(56) **References Cited**

**U.S. PATENT DOCUMENTS**

D269,249 S \* 6/1983 Cillario ..... D9/424  
D281,827 S \* 12/1985 Bakic ..... D28/83

*Primary Examiner* — David G Muller

*Assistant Examiner* — Nathan M Johnston

(74) *Attorney, Agent, or Firm* — Mintz Levin Cohn Ferris  
Glovsky and Popeo, P.C.

(57) **CLAIM**

The ornamental design for an auto-injector, as shown and described.

**DESCRIPTION**

FIG. 1 is a top, right side, front perspective view of an auto-injector showing our new design;  
FIG. 2 is a front elevation view thereof;  
FIG. 3 is a rear elevation view thereof;  
FIG. 4 is a left side elevation view thereof;  
FIG. 5 is a right side elevation view thereof;  
FIG. 6 is a top plan view thereof; and,  
FIG. 7 is a bottom plan view thereof.

**1 Claim, 7 Drawing Sheets**

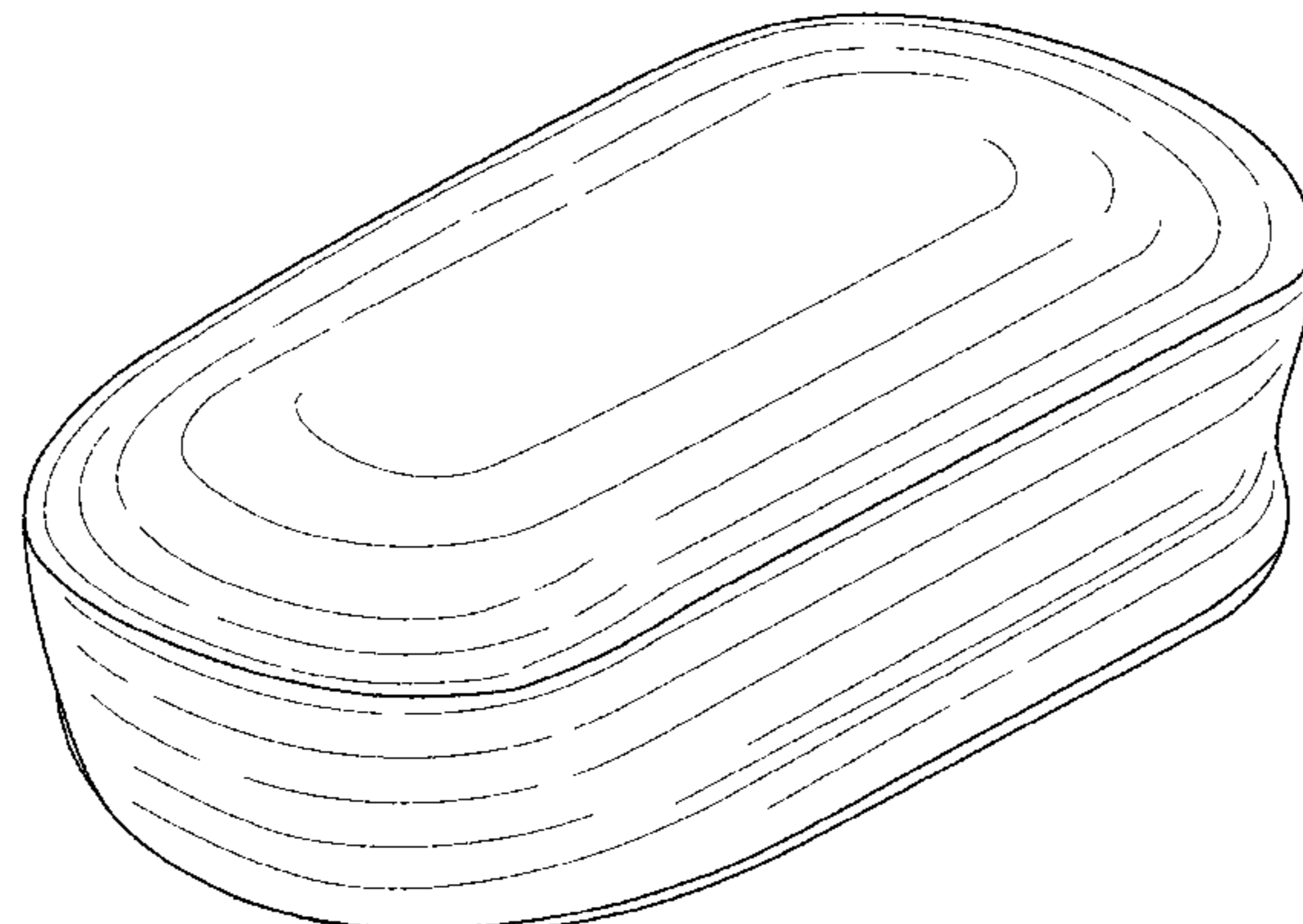

(56)

References Cited

U.S. PATENT DOCUMENTS

D687,536 S 8/2013 Guarraia et al.  
 D694,102 S \* 11/2013 Bellamah ..... D9/424  
 D699,855 S 2/2014 Netzel et al.  
 D733,288 S \* 6/2015 Althorpe ..... D24/110  
 D744,109 S \* 11/2015 Yoneta ..... D24/186  
 D744,110 S \* 11/2015 Kubo ..... D24/186  
 D748,273 S \* 1/2016 Chang ..... D24/186  
 D759,236 S 6/2016 Preiss et al.  
 D760,374 S \* 6/2016 Nagar ..... D24/108  
 D769,438 S 10/2016 Crosby et al.  
 D774,640 S 12/2016 Tyce et al.  
 D776,270 S \* 1/2017 Wilcox ..... D24/127  
 D776,873 S 1/2017 Levi et al.  
 9,707,335 B2 7/2017 Agard et al.  
 D794,770 S \* 8/2017 Wu ..... D24/108  
 9,782,545 B2 10/2017 Gross et al.  
 D804,015 S \* 11/2017 Lamba ..... D24/110  
 D804,019 S 11/2017 Costello et al.  
 D804,042 S \* 11/2017 Cohrs ..... D24/186  
 D805,190 S \* 12/2017 Costello ..... D24/113  
 D805,633 S \* 12/2017 Costello ..... D24/113  
 D806,232 S \* 12/2017 Hwang ..... D24/112  
 D806,234 S 12/2017 Costello et al.  
 D806,880 S \* 1/2018 Henning ..... D24/186  
 2008/0281270 A1 \* 11/2008 Cross ..... A61M 5/1413  
 604/122

2009/0216194 A1 \* 8/2009 Elgard Pedersen .....  
 A61M 5/14248  
 604/151  
 2010/0114026 A1 5/2010 Karratt et al.  
 2012/0078181 A1 \* 3/2012 Smith ..... A61M 5/14216  
 604/152  
 2014/0058349 A1 \* 2/2014 Bazargan ..... A61M 5/1456  
 604/500  
 2014/0207065 A1 7/2014 Yavorsky  
 2014/0213975 A1 \* 7/2014 Clemente ..... A61M 5/158  
 604/151  
 2015/0051573 A1 \* 2/2015 Tieck ..... A61M 5/14216  
 604/500  
 2015/0057613 A1 \* 2/2015 Clemente ..... A61M 5/14566  
 604/148  
 2015/0250943 A1 \* 9/2015 Momose ..... A61M 5/14276  
 604/151  
 2015/0306307 A1 \* 10/2015 Cole ..... A61M 5/14248  
 604/508  
 2016/0058941 A1 3/2016 Wu et al.  
 2016/0317738 A1 \* 11/2016 Cross ..... A61M 5/1454  
 2016/0369789 A1 12/2016 Alderete, Jr. et al.  
 2017/0043101 A1 \* 2/2017 Cole ..... A61M 25/0631  
 2017/0182243 A1 6/2017 Cole et al.  
 2017/0224910 A1 8/2017 Yodfat et al.  
 2017/0224915 A1 8/2017 Destefano et al.  
 2017/0281864 A1 \* 10/2017 Searle ..... G06F 19/3468  
 2017/0290975 A1 10/2017 Barmaimon et al.  
 2018/0021508 A1 1/2018 Destefano et al.

\* cited by examiner

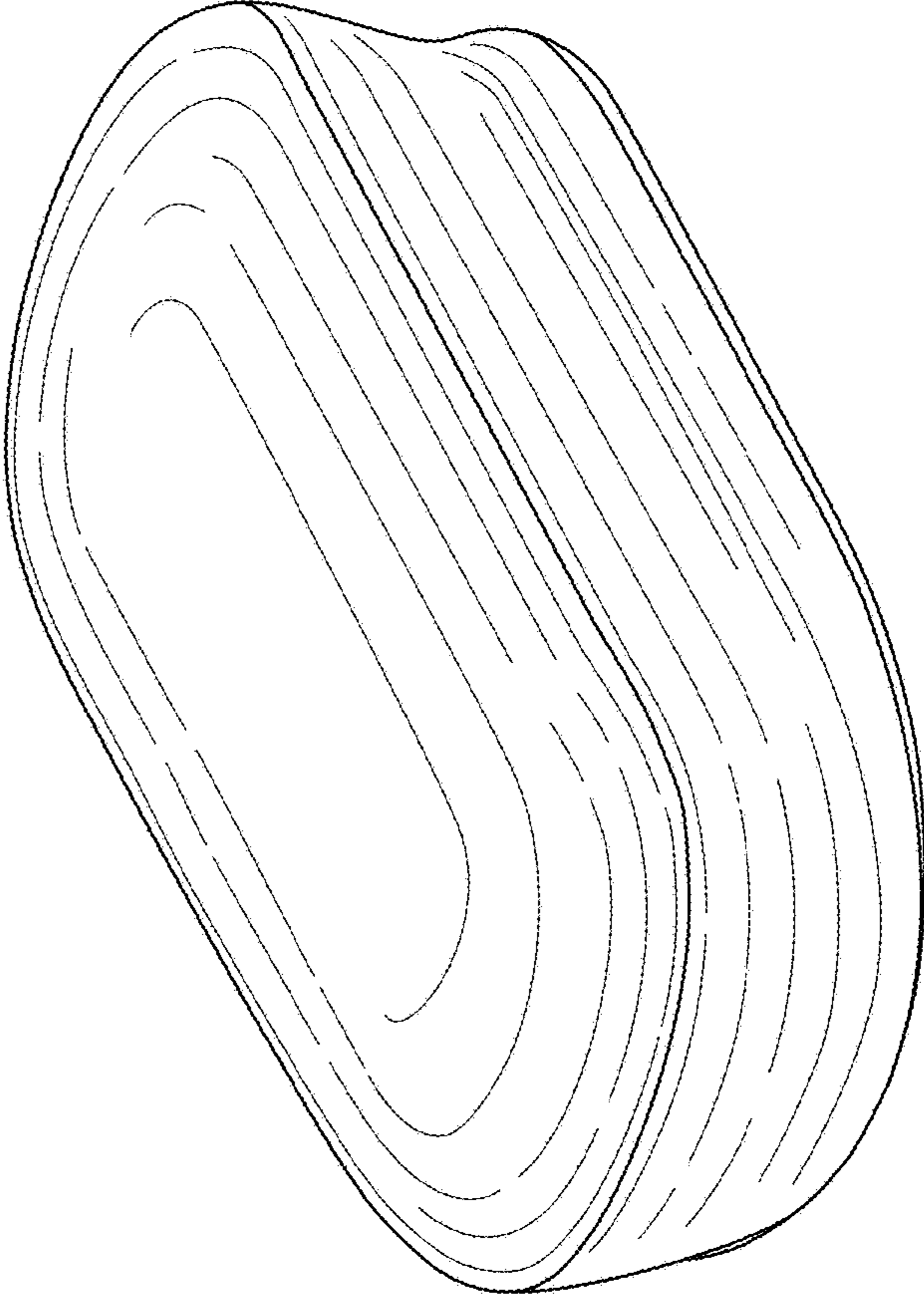

FIG.1

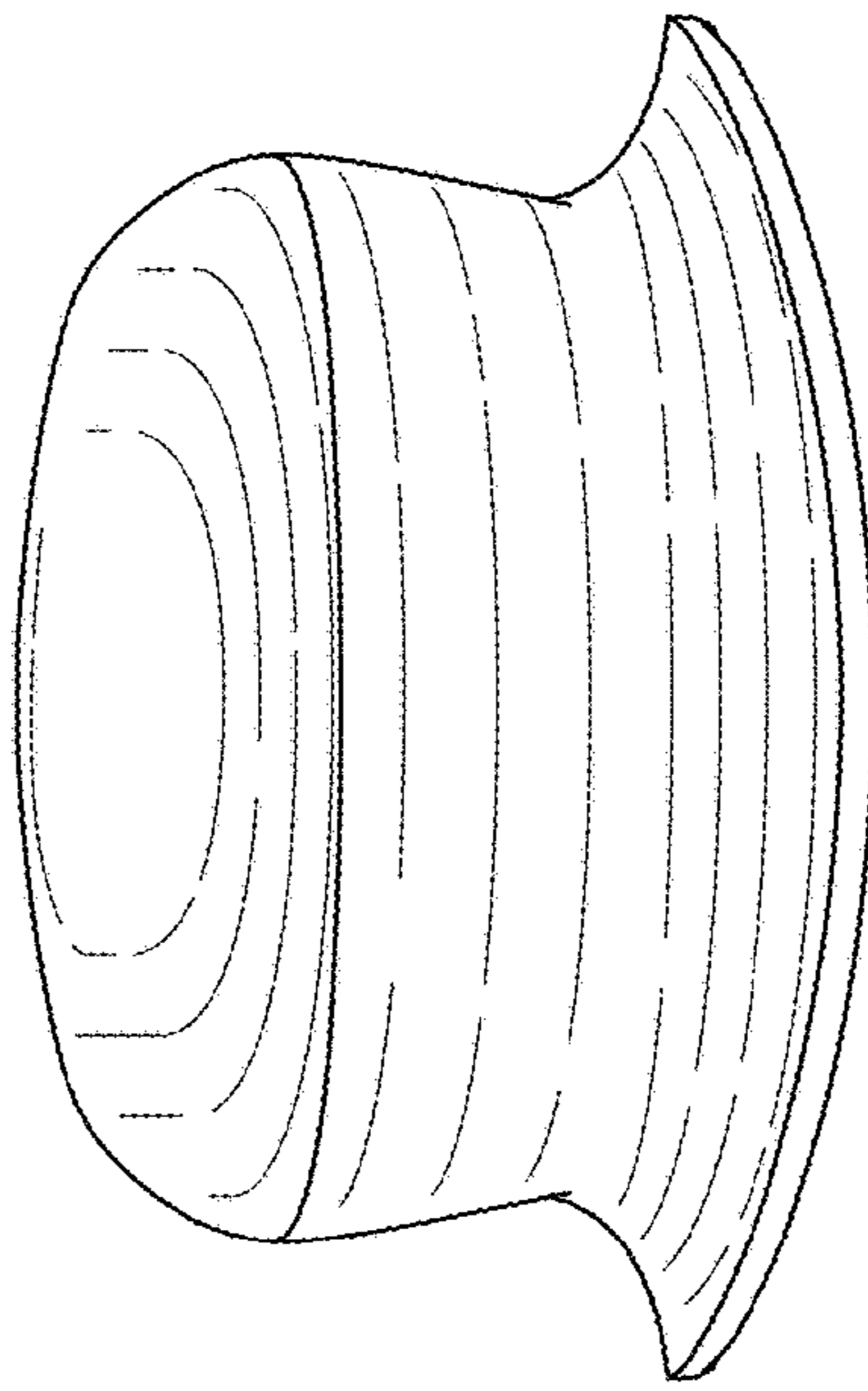

FIG.2

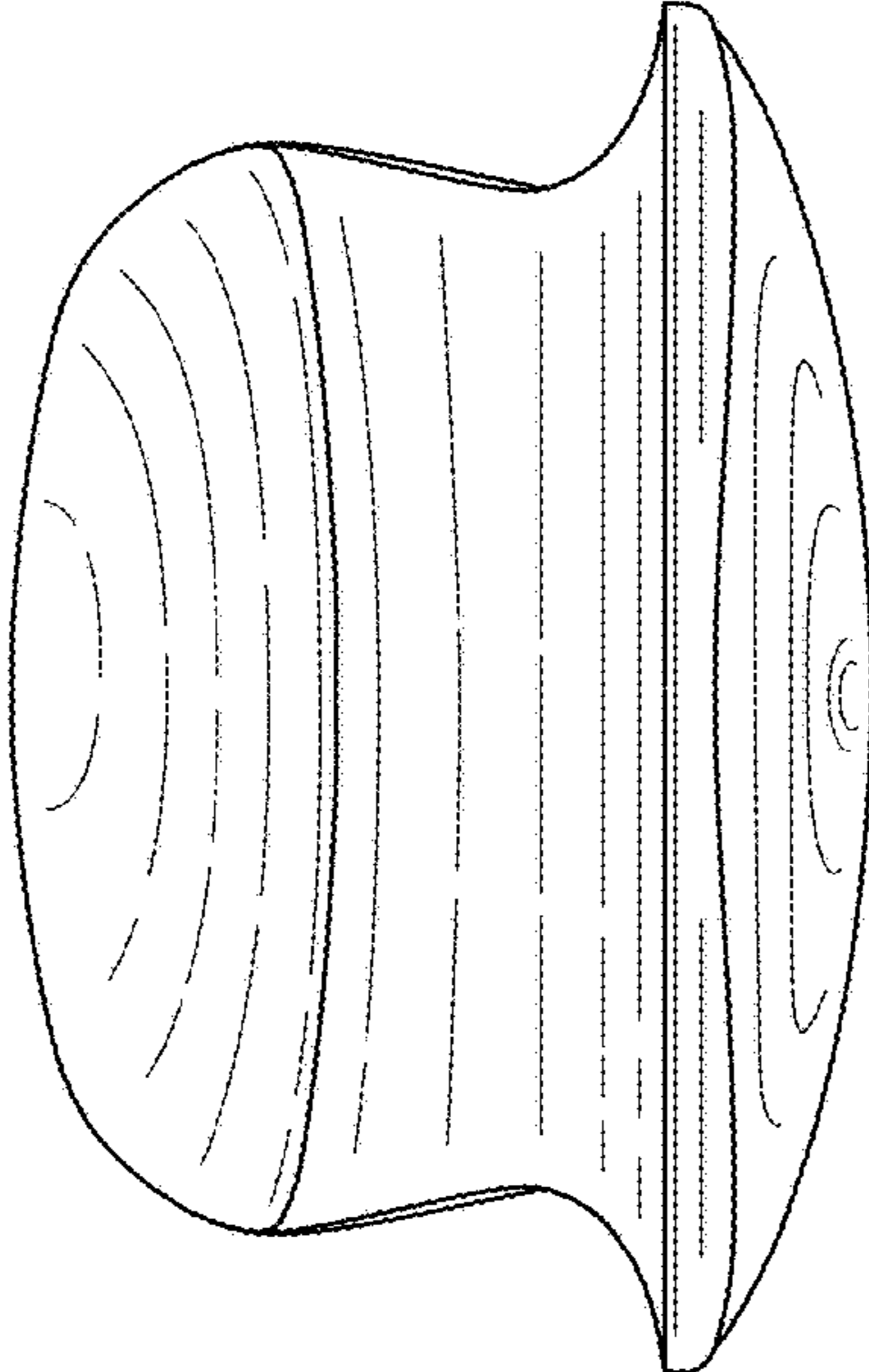

FIG.3



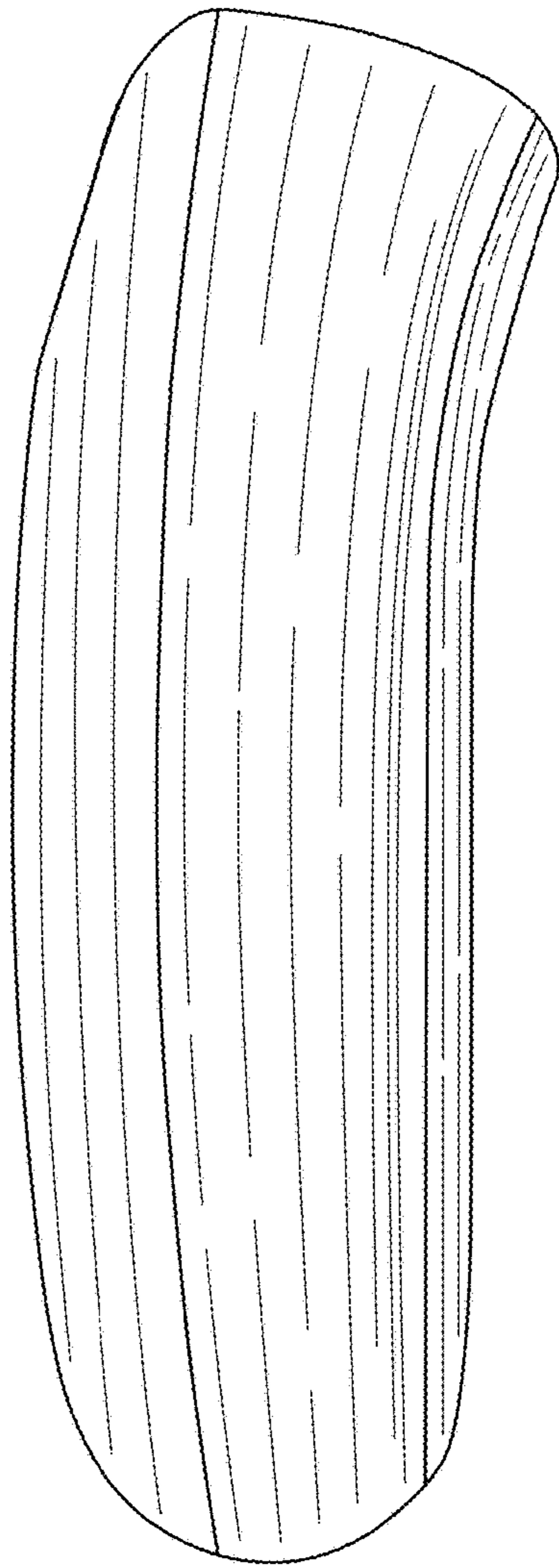

FIG.4

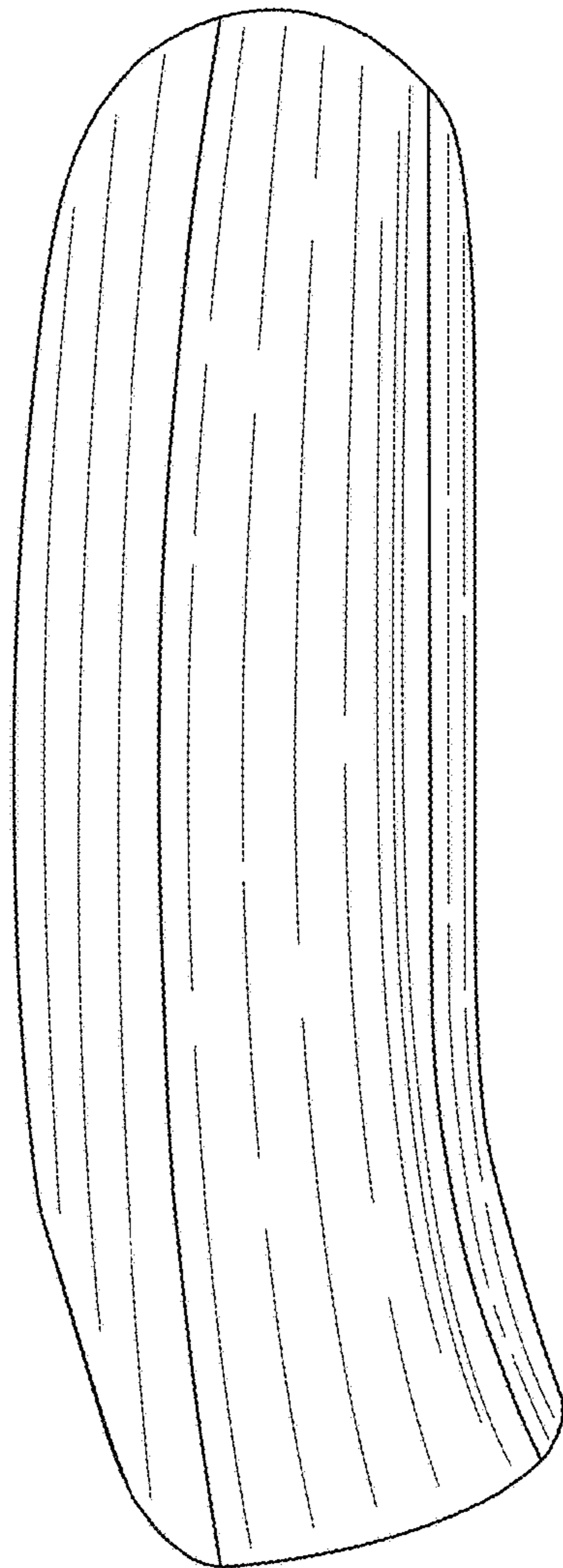

FIG.5

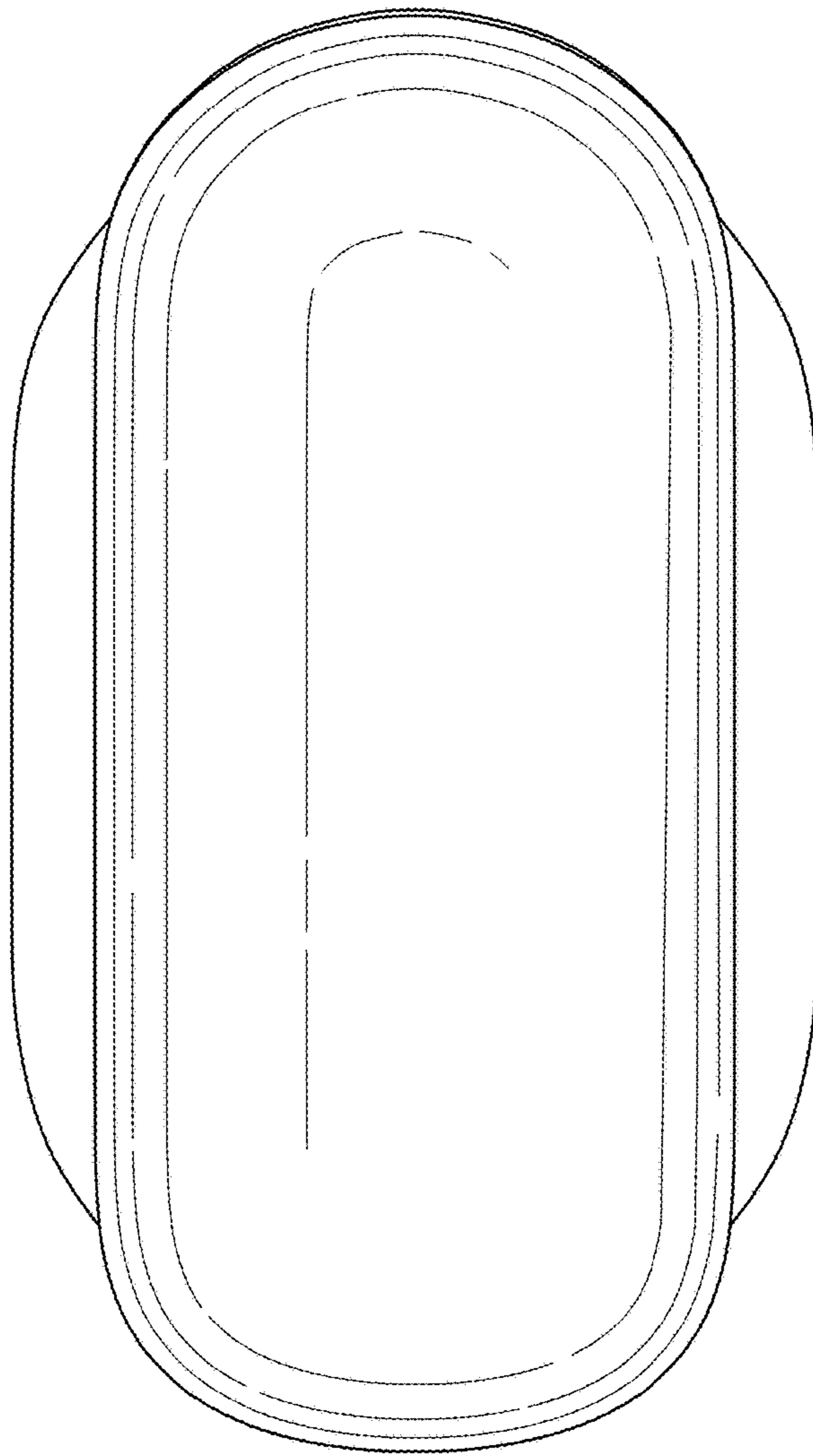

FIG. 6



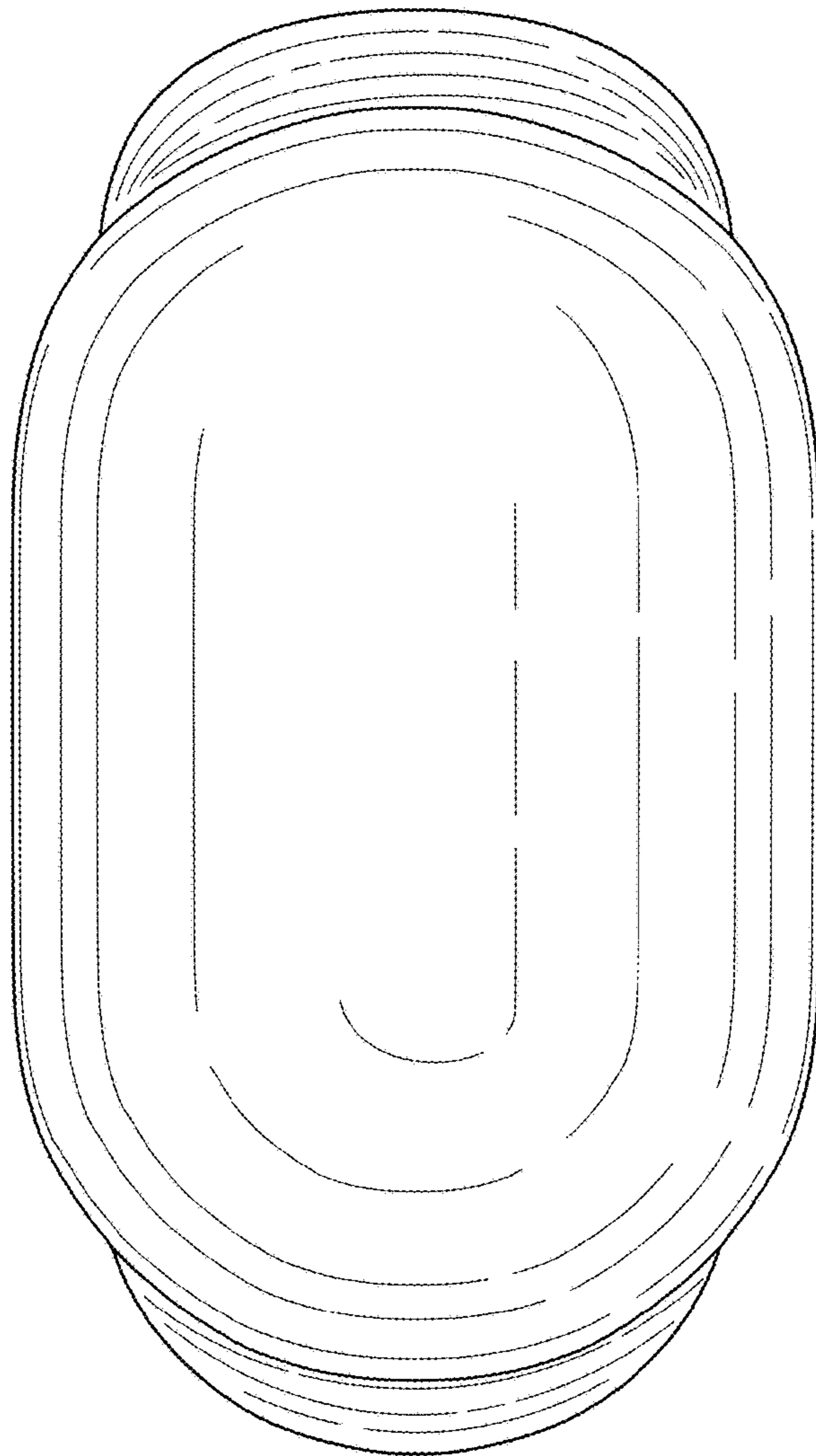

FIG.7