

US00D839409S

(12) **United States Design Patent**
Massie et al.

(10) **Patent No.:** **US D839,409 S**
(45) **Date of Patent:** **** Jan. 29, 2019**

(54) **ORAL IRRIGATOR UNIT**

(71) Applicant: **WATER PIK, INC.**, Fort Collins, CO (US)

(72) Inventors: **Carson Noel Massie**, Seattle, WA (US);
Jeffrey Ladwig, Seattle, WA (US)

(73) Assignee: **WATER PIK, INC.**, Fort Collins, CO (US)

(**) Term: **15 Years**

(21) Appl. No.: **29/587,888**

(22) Filed: **Dec. 15, 2016**

(51) **LOC (11) Cl.** **24-02**

(52) **U.S. Cl.**
USPC **D24/111**

(58) **Field of Classification Search**
USPC D24/108, 111–113, 133, 152, 176;
D4/101, 138
See application file for complete search history.

(56) **References Cited**

U.S. PATENT DOCUMENTS

555,588 A 3/1896 Spencer
1,278,225 A 9/1918 Schamberg
(Continued)

FOREIGN PATENT DOCUMENTS

CA 851479 9/1970
CH 655237 4/1986
(Continued)

OTHER PUBLICATIONS

US RE27,274, 01/1972, Mattingly (withdrawn)
(Continued)

Primary Examiner — Eric L Goodman

Assistant Examiner — Aula Soroush

(74) *Attorney, Agent, or Firm* — Dorsey & Whitney LLP

(57) **CLAIM**

We claim the ornamental design for an oral irrigator unit, as shown and described.

DESCRIPTION

FIG. 1 is a front isometric view of a first embodiment of an oral irrigator unit.

FIG. 2 is a front elevation view of the oral irrigator unit of FIG. 1.

FIG. 3 is a rear elevation view of the oral irrigator unit of FIG. 1.

FIG. 4 is a left side elevation view of the oral irrigator unit of FIG. 1.

FIG. 5 is a right side elevation view of the oral irrigator unit of FIG. 1.

FIG. 6 is a top plan view of the oral irrigator unit of FIG. 1.

FIG. 7 is a bottom plan view of the oral irrigator unit of FIG. 1.

FIG. 8 is a front isometric view of a second embodiment of an oral irrigator unit.

FIG. 9 is a front elevation view of the oral irrigator unit of FIG. 8.

FIG. 10 is a rear elevation view of the oral irrigator unit of FIG. 8.

FIG. 11 is a left side elevation view of the oral irrigator unit of FIG. 8.

FIG. 12 is a right side elevation view of the oral irrigator unit of FIG. 8.

FIG. 13 is a top plan view of the oral irrigator unit of FIG. 8; and,

FIG. 14 is a bottom plan view of the oral irrigator unit of FIG. 8.

The broken lines in the drawings depict portions of the oral irrigator unit that form no part of the claimed design.

1 Claim, 14 Drawing Sheets

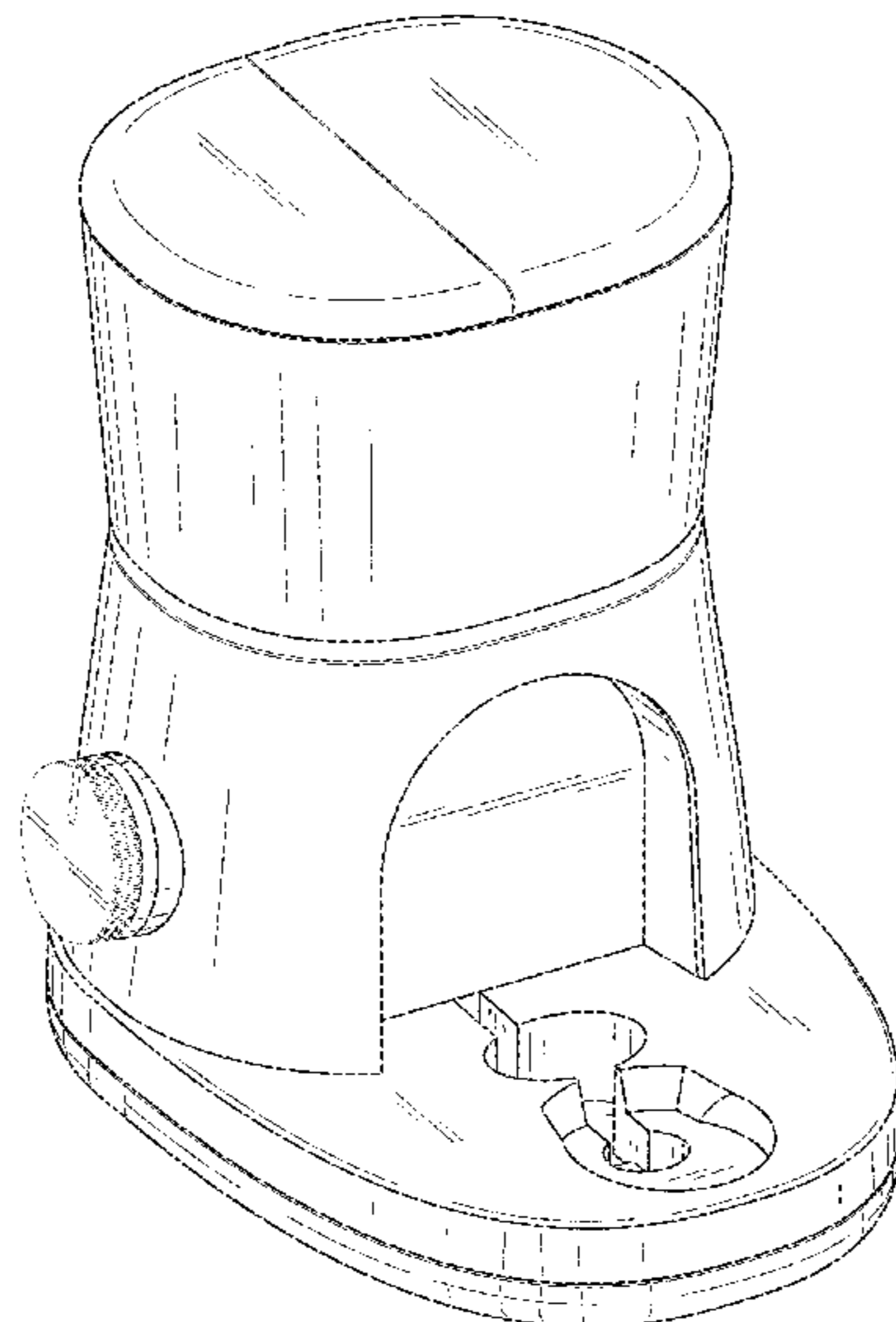

(56)

References Cited

U.S. PATENT DOCUMENTS

1,452,258 A	4/1923	Smith	3,583,609 A	6/1971	Oppenheimer
1,464,419 A	8/1923	Gill	3,590,813 A	7/1971	Roszyk
1,480,310 A	1/1924	Smith	3,608,548 A	9/1971	Lewis
1,498,267 A	6/1924	Hachman	3,612,045 A	10/1971	Dudas
1,602,742 A	10/1926	Bennet	D222,862 S	1/1972	Cook
1,650,686 A	11/1927	Binks	3,636,947 A	1/1972	Balamuth
1,669,889 A	5/1928	Andrews et al.	3,651,576 A	3/1972	Massa
1,681,320 A	8/1928	Bergl et al.	3,669,101 A	6/1972	Kleiner
1,933,454 A	10/1933	Sidney	3,703,170 A	11/1972	Ryckman, Jr.
1,940,111 A	12/1933	Austin	3,718,974 A	3/1973	Buchtel et al.
D93,019 S	8/1934	Hose	3,747,595 A	7/1973	Grossan
1,977,782 A	10/1934	Roy	3,768,472 A	10/1973	Hodosh et al.
2,107,686 A	2/1938	Bramsen et al.	3,771,186 A	11/1973	Moret et al.
2,421,498 A	6/1947	Guedel	3,783,364 A	1/1974	Gallanis et al.
D159,872 S	8/1950	Skold	3,809,506 A	5/1974	Malcosky
2,531,730 A	11/1950	Henderson	3,809,977 A	5/1974	Balamuth et al.
2,595,666 A	5/1952	Hutson	3,811,432 A	5/1974	Moret
2,669,233 A	2/1954	Friend	3,820,532 A	6/1974	Eberhardt et al.
2,709,227 A	5/1955	Foley et al.	3,827,147 A	8/1974	Condon
2,733,713 A	2/1956	Kabnick	3,837,166 A	9/1974	Hiraoka
2,783,919 A	3/1957	Ansell	3,840,795 A	10/1974	Roszyk et al.
2,794,437 A	6/1957	Tash	3,847,145 A	11/1974	Grossan
2,870,932 A	1/1959	Davis	3,854,209 A	12/1974	Franklin et al.
2,984,452 A	5/1961	Hooper	3,863,628 A	2/1975	Vit
3,089,490 A	5/1963	Goldberg	3,871,560 A	3/1975	Crippa
3,096,913 A	7/1963	Jousson	3,874,506 A	4/1975	Hill et al.
3,144,867 A	8/1964	Trupp et al.	3,911,796 A	10/1975	Hull et al.
D202,041 S	8/1965	Burzlauff	3,912,125 A	10/1975	Acklin
3,209,956 A	10/1965	McKenzie	3,943,628 A	3/1976	Kronman et al.
3,216,619 A	11/1965	Richards et al.	3,959,883 A	6/1976	Walls et al.
3,225,759 A	12/1965	Drapen et al.	3,973,558 A	8/1976	Stouffer et al.
3,227,158 A	1/1966	Mattingly	3,977,084 A	8/1976	Sloan
3,266,623 A	8/1966	Poferl	4,001,526 A	1/1977	Olson
3,297,558 A	1/1967	Hillquist	4,004,302 A	1/1977	Hori
D208,778 S	10/1967	Koch	4,007,739 A	2/1977	Bron et al.
D209,202 S	11/1967	Fulton et al.	4,013,227 A	3/1977	Herrera
D209,203 S	11/1967	Mattingly et al.	4,022,114 A	5/1977	Hansen, III
D209,204 S	11/1967	St. Clair et al.	4,052,002 A	10/1977	Stouffer et al.
D209,395 S	11/1967	Gilbert	D246,667 S	12/1977	Mackay et al.
D210,018 S	1/1968	Mattingly et al.	D246,668 S	12/1977	Mackay et al.
D210,019 S	1/1968	Johnson et al.	4,060,870 A	12/1977	Cannarella
3,370,214 A	2/1968	Aymar	4,075,761 A	2/1978	Behne et al.
3,391,696 A	7/1968	Woodward	4,078,558 A	3/1978	Woog et al.
3,393,673 A	7/1968	Mattingly et al.	4,094,311 A	6/1978	Hudson
3,400,999 A	9/1968	Goldstein	4,108,167 A	8/1978	Hickman et al.
3,418,552 A	12/1968	Holmes	4,108,178 A	8/1978	Betush
3,420,228 A	1/1969	Kalbfeld	4,109,650 A	8/1978	Peclard
3,425,410 A	2/1969	Cammack	4,122,845 A	10/1978	Stouffer et al.
3,453,969 A	7/1969	Mattingly	4,133,971 A	1/1979	Boyd et al.
3,465,751 A	9/1969	Powers	4,135,501 A	1/1979	Leunissan
3,467,083 A	9/1969	Mattingly	4,141,352 A	2/1979	Ebner et al.
3,467,286 A	9/1969	Ostrowsky	4,144,646 A	3/1979	Takemoto et al.
D215,920 S	11/1969	McCarty et al.	4,149,315 A	4/1979	Page, Jr. et al.
3,487,828 A	1/1970	Troy	4,154,375 A	5/1979	Bippus
3,489,268 A	1/1970	Meierhoefer	4,160,383 A	7/1979	Rauschenberger
3,495,587 A	2/1970	Freedman	4,171,572 A	10/1979	Nash
3,496,933 A	2/1970	Lloyd	4,182,038 A	1/1980	Fleer
3,499,440 A	3/1970	Gibbs	4,200,235 A	4/1980	Monschke
3,500,824 A	3/1970	Gilbert	4,201,200 A	5/1980	Hubner
3,501,203 A	3/1970	Falk	4,210,380 A	7/1980	Brzostek
3,502,072 A	3/1970	Stillman	4,215,476 A	8/1980	Armstrong
3,517,669 A	6/1970	Buono et al.	4,219,618 A	8/1980	Leonard
D218,270 S	8/1970	Soper	4,227,878 A	10/1980	Lohn
3,522,801 A	8/1970	Robinson	4,229,634 A	10/1980	Hickman et al.
3,532,221 A	10/1970	Kaluhiokalani et al.	4,236,889 A	12/1980	Wright
3,536,065 A	10/1970	Moret	D258,097 S	2/1981	Wistrand
3,537,444 A	11/1970	Garn	4,248,589 A	2/1981	Lewis
3,538,950 A	11/1970	Porteners	4,249,899 A	2/1981	Davis
3,547,110 A	12/1970	Balamuth	4,257,458 A	3/1981	Kondo et al.
3,561,433 A	2/1971	Kovach	4,262,799 A	4/1981	Perrett
D220,334 S	3/1971	Mackay et al.	4,266,934 A	5/1981	Pernot
3,570,525 A	3/1971	Borsum	4,276,023 A	6/1981	Phillips et al.
3,572,375 A	3/1971	Rosenberg	4,276,880 A	7/1981	Malmin
3,578,884 A	5/1971	Jacobson	4,302,186 A	11/1981	Cammack et al.
D220,996 S	6/1971	Irons	4,303,064 A	12/1981	Buffa
			4,303,070 A	12/1981	Ichikawa et al.
			4,306,862 A	12/1981	Knox
			4,315,741 A	2/1982	Reichl
			4,319,568 A	3/1982	Tregoning

(56)

References Cited

U.S. PATENT DOCUMENTS

4,331,422 A	5/1982	Heyman	4,902,225 A	2/1990	Lohn
4,337,040 A	6/1982	Cammack et al.	4,903,687 A	2/1990	Lih-Sheng
4,340,365 A	7/1982	Pisanu	4,906,187 A	3/1990	Amadera
4,340,368 A	7/1982	Lococo	4,907,744 A	3/1990	Jousson
D266,117 S	9/1982	Oberheim	4,915,304 A	4/1990	Campani
4,353,694 A	10/1982	Pelerin	4,925,450 A	5/1990	Imonti et al.
4,363,626 A	12/1982	Schmidt et al.	4,928,675 A	5/1990	Thornton
4,365,376 A	12/1982	Oda et al.	4,930,660 A	6/1990	Porteous
4,370,131 A	1/1983	Banko	4,941,459 A	7/1990	Mathur
4,374,354 A	2/1983	Petrovic et al.	4,950,159 A	8/1990	Hansen
4,382,167 A	5/1983	Maruyama et al.	4,958,629 A	9/1990	Peace et al.
4,382,786 A	5/1983	Lohn	4,958,751 A	9/1990	Curtis et al.
D270,000 S	8/1983	Ketler	4,959,199 A	9/1990	Brewer
4,396,011 A	8/1983	Mack et al.	4,961,698 A	10/1990	Vlock
4,412,823 A	11/1983	Sakai et al.	4,966,551 A	10/1990	Betush
4,416,628 A	11/1983	Cammack	4,969,874 A	11/1990	Michel et al.
4,442,830 A	4/1984	Markau	4,973,246 A	11/1990	Black
4,442,831 A	4/1984	Trenary	4,973,247 A	11/1990	Varnes et al.
4,452,238 A	6/1984	Kerr	4,973,250 A	11/1990	Milman
4,454,866 A	6/1984	Fayen	4,975,054 A	12/1990	Esrock
4,512,769 A	4/1985	Kozam et al.	4,979,503 A	12/1990	Chernack
4,517,962 A	5/1985	Heckele	4,979,504 A	12/1990	Mills
4,531,912 A	7/1985	Schuss et al.	4,989,590 A	2/1991	Baum et al.
4,531,913 A	7/1985	Taguchi	4,998,880 A	3/1991	Nerli
4,534,340 A	8/1985	Kerr et al.	5,013,241 A	5/1991	Von Gutfeld et al.
4,552,130 A	11/1985	Kinoshita	5,014,884 A	5/1991	Wunsch
4,561,214 A	12/1985	Inoue	5,019,054 A	5/1991	Clement et al.
D283,374 S	4/1986	Cheuk-Yiu	5,027,798 A	7/1991	Primiano
4,585,415 A	4/1986	Hommann	5,029,576 A	7/1991	Evans, Sr.
4,591,777 A	5/1986	McCarty et al.	5,033,617 A	7/1991	Hartwein et al.
4,592,728 A	6/1986	Davis	5,033,961 A	7/1991	Kandler et al.
4,602,906 A	7/1986	Grunenfelder	D318,918 S	8/1991	Hartwein
4,607,627 A	8/1986	Leber et al.	5,046,486 A	9/1991	Gulke et al.
4,613,074 A	9/1986	Schulze	5,049,071 A	9/1991	Davis et al.
4,619,009 A	10/1986	Rosenstatter	5,060,825 A	10/1991	Palmer et al.
4,619,612 A	10/1986	Weber et al.	5,061,180 A	10/1991	Wiele
4,629,425 A	12/1986	Detsch	5,062,795 A	11/1991	Woog
4,636,198 A	1/1987	Stade	5,064,168 A	11/1991	Raines et al.
4,642,037 A	2/1987	Fritchman	D322,314 S	12/1991	Ohbayashi
4,644,937 A	2/1987	Hommann	5,071,346 A	12/1991	Domaas
4,645,488 A	2/1987	Matukas	5,082,115 A	1/1992	Hutcheson
4,647,831 A	3/1987	O'Malley et al.	5,082,443 A	1/1992	Lohn
4,648,838 A	3/1987	Schlachter	5,085,317 A	2/1992	Jensen et al.
4,650,475 A	3/1987	Smith et al.	5,086,756 A	2/1992	Powell
4,655,198 A	4/1987	Hommann	5,095,893 A	3/1992	Rawden, Jr.
4,669,453 A	6/1987	Atkinson et al.	5,098,291 A	3/1992	Curtis et al.
4,672,953 A	6/1987	DiVito	5,098,676 A	3/1992	Brooks, Jr.
4,673,396 A	6/1987	Urbaniak	5,100,319 A	3/1992	Baum
D291,354 S	8/1987	Camens	5,117,871 A	6/1992	Gardner et al.
4,716,352 A	12/1987	Hurn et al.	5,125,835 A	6/1992	Young
4,749,340 A	6/1988	Ikeda et al.	5,127,831 A	7/1992	Bab
4,770,632 A	9/1988	Ryder et al.	5,142,723 A	9/1992	Lustig et al.
D298,565 S	11/1988	Kohler, Jr. et al.	5,150,841 A	9/1992	Silvenis et al.
4,783,321 A	11/1988	Spence	5,172,810 A	12/1992	Brewer
4,787,845 A	11/1988	Valentine	5,173,273 A	12/1992	Brewer
4,787,847 A	11/1988	Martin et al.	5,183,035 A	2/1993	Weir
4,798,292 A	1/1989	Hauze	5,197,458 A	3/1993	Ito et al.
4,803,974 A	2/1989	Powell	5,197,460 A	3/1993	Ito et al.
4,804,364 A	2/1989	Dieras et al.	5,199,871 A	4/1993	Young
4,810,148 A	3/1989	Aisa et al.	5,203,697 A	4/1993	Malmin
4,818,229 A	4/1989	Vasile	5,203,769 A	4/1993	Clement et al.
4,820,152 A	4/1989	Warrin et al.	5,204,004 A	4/1993	Johnston et al.
4,821,923 A	4/1989	Skorka	5,208,933 A	5/1993	Lustig et al.
4,824,368 A	4/1989	Hickman	5,215,193 A	6/1993	Dennis
4,826,431 A	5/1989	Fujimura et al.	5,218,956 A	6/1993	Handler et al.
4,827,551 A	5/1989	Maser et al.	5,220,914 A	6/1993	Thompson
4,832,683 A	5/1989	Idemoto et al.	5,228,646 A	7/1993	Raines
4,854,869 A	8/1989	Lawhorn	5,230,624 A	7/1993	Wolf et al.
4,861,340 A	8/1989	Smith et al.	5,232,687 A	8/1993	Geimer
4,862,876 A	9/1989	Lih-Sheng	5,235,968 A	8/1993	Woog
4,864,918 A	9/1989	Martin	5,241,714 A	9/1993	Barry
4,869,720 A	9/1989	Chernack	5,246,367 A	9/1993	Ito et al.
4,880,382 A	11/1989	Moret et al.	5,252,064 A	10/1993	Baum et al.
4,886,452 A	12/1989	Lohn	D341,200 S	11/1993	Yoshimoto
4,900,252 A	2/1990	Liefke et al.	5,257,933 A	11/1993	Jousson
			5,261,448 A	11/1993	Furuya et al.
			D341,943 S	12/1993	Si-Hoe
			5,267,586 A	12/1993	Jankavaara
			5,269,684 A	12/1993	Fischer

(56)

References Cited

U.S. PATENT DOCUMENTS

5,281,137 A	1/1994	Jousson	5,746,595 A	5/1998	Ford
5,281,139 A	1/1994	Frank et al.	5,749,726 A	5/1998	Kinsel
5,282,745 A	2/1994	Wiltrout et al.	5,759,502 A	6/1998	Spencer et al.
5,286,192 A	2/1994	Dixon	5,779,471 A	7/1998	Tseng et al.
5,286,201 A	2/1994	Yu	5,779,654 A	7/1998	Foley et al.
5,295,832 A	3/1994	Evans	5,795,153 A	8/1998	Rechmann
5,297,962 A	3/1994	O'Connor et al.	5,796,325 A	8/1998	Lundell et al.
D346,212 S	4/1994	Hosl	5,833,065 A	11/1998	Burgess
5,301,381 A	4/1994	Klupt	5,836,030 A	11/1998	Hazeu et al.
5,302,123 A	4/1994	Bechard	D402,744 S	12/1998	Zuege
5,317,691 A	5/1994	Traeger	5,851,079 A	12/1998	Horstman et al.
5,321,865 A	6/1994	Kaeser	D403,511 S	1/1999	Serbinski
5,323,770 A	6/1994	Ito et al.	D406,334 S	3/1999	Rosenthal et al.
5,331,704 A	7/1994	Rosen et al.	5,876,201 A	3/1999	Wilson et al.
5,344,317 A	9/1994	Pacher et al.	D408,511 S	4/1999	Allen et al.
5,346,677 A	9/1994	Risk	5,901,397 A	5/1999	Häfele et al.
5,349,896 A	9/1994	Delaney	5,934,902 A	8/1999	Abahusayn
D351,892 S	10/1994	Wolf et al.	D413,975 S	9/1999	Maeda
5,360,338 A	11/1994	Waggoner	D416,999 S	11/1999	Miyamoto
5,368,548 A	11/1994	Jousson	D417,082 S	11/1999	Classen et al.
5,370,534 A	12/1994	Wolf et al.	5,993,402 A	11/1999	Sauer et al.
D354,168 S	1/1995	Hartwein	6,030,215 A	2/2000	Ellion et al.
D354,559 S	1/1995	Knute	6,038,960 A	3/2000	Fukushima et al.
5,378,149 A	1/1995	Stropko	6,039,180 A	3/2000	Grant
5,380,201 A	1/1995	Kawata	6,047,429 A	4/2000	Wu
D356,864 S	3/1995	Woog	D424,181 S	5/2000	Caplow
5,399,089 A	3/1995	Eichman et al.	D425,615 S	5/2000	Bachman et al.
D358,883 S	5/1995	Vos	D425,981 S	5/2000	Bachman et al.
5,456,672 A	10/1995	Diederich et al.	6,056,548 A	5/2000	Neuberger et al.
5,465,445 A	11/1995	Yeh	6,056,710 A	5/2000	Bachman et al.
5,467,495 A	11/1995	Boland et al.	D426,633 S	6/2000	Bachman et al.
5,468,148 A	11/1995	Ricks	6,089,865 A	7/2000	Edgar
5,470,305 A	11/1995	Arnett et al.	6,116,866 A	9/2000	Tomita et al.
5,474,450 A	12/1995	Chronister	6,120,755 A	9/2000	Jacobs
5,474,451 A	12/1995	Dalrymple et al.	6,124,699 A	9/2000	Suzuki et al.
5,476,379 A	12/1995	Disel	D434,500 S	11/2000	Pollock et al.
5,484,281 A	1/1996	Renow et al.	6,159,006 A	12/2000	Cook et al.
5,487,877 A	1/1996	Choi	6,164,967 A	12/2000	Sale et al.
5,490,779 A	2/1996	Malmin	D435,905 S	1/2001	Bachman et al.
5,505,916 A	4/1996	Berry, Jr.	D437,049 S	1/2001	Hartwein
D369,656 S	5/1996	Vos	6,193,512 B1	2/2001	Wallace
D370,125 S	5/1996	Craft et al.	6,193,932 B1	2/2001	Wu et al.
5,525,058 A	6/1996	Gallant et al.	6,199,239 B1	3/2001	Dickerson
5,526,841 A	6/1996	Detsch et al.	6,200,134 B1	3/2001	Kovac
5,540,587 A	7/1996	Malmin	D439,781 S	4/2001	Spore
5,547,374 A	8/1996	Coleman	6,217,835 B1	4/2001	Riley et al.
D373,631 S	9/1996	Maeda et al.	D441,861 S	5/2001	Haffliger
5,554,014 A	9/1996	Becker	6,233,773 B1	5/2001	Karge et al.
5,554,025 A	9/1996	Kinsel	6,234,205 B1	5/2001	D'Amelio et al.
5,556,001 A	9/1996	Weissman et al.	6,237,178 B1	5/2001	Krammer et al.
5,564,629 A	10/1996	Weissman et al.	6,247,929 B1	6/2001	Bachman et al.
D376,893 S	12/1996	Gornet	6,280,190 B1	8/2001	Hoffman
D377,091 S	12/1996	Scott, Sr.	D448,236 S	9/2001	Murray
5,613,259 A	3/1997	Craft et al.	6,293,792 B1	9/2001	Hanson
5,616,028 A	4/1997	Häfele et al.	D449,884 S	10/2001	Tobin et al.
5,626,472 A	5/1997	Pennetta	6,299,419 B1	10/2001	Hunklinger
5,634,791 A	6/1997	Matsuura et al.	D453,453 S	2/2002	Lun
5,636,987 A	6/1997	Serfaly	D455,201 S	4/2002	Jones
5,640,735 A	6/1997	Manning	D455,203 S	4/2002	Jones
D382,407 S	8/1997	Craft et al.	6,363,565 B1	4/2002	Paffrath
5,653,591 A	8/1997	Loge	D457,949 S	5/2002	Krug
5,659,995 A	8/1997	Hoffman	D464,799 S	10/2002	Crossman et al.
5,667,483 A	9/1997	Santos	6,468,482 B1	10/2002	Frieze et al.
D386,576 S	11/1997	Wang et al.	6,475,173 B1	11/2002	Bachman et al.
5,683,192 A	11/1997	Kilfoil	6,485,451 B1	11/2002	Roberts et al.
5,685,829 A	11/1997	Allen	6,497,375 B1	12/2002	Srinath et al.
5,685,851 A	11/1997	Murphy et al.	6,497,572 B2	12/2002	Hood et al.
5,697,784 A	12/1997	Häfele et al.	D468,422 S	1/2003	McCurrach
D388,612 S	1/1998	Stutzer et al.	6,502,584 B1	1/2003	Fordham
D388,613 S	1/1998	Stutzer et al.	D470,660 S	2/2003	Schaber
D389,091 S	1/1998	Dickinson	6,532,837 B1	3/2003	Magussen, Jr.
5,709,545 A	1/1998	Johnston et al.	6,558,344 B2	5/2003	McKinnon et al.
D390,934 S	2/1998	McKeone	6,561,808 B2	5/2003	Neuberger et al.
5,716,007 A	2/1998	Nottingham et al.	D475,346 S	6/2003	McCurrach et al.
5,718,668 A	2/1998	Arnett et al.	D476,743 S	7/2003	D'Silva
			6,589,477 B1	7/2003	Frieze et al.
			6,602,071 B1	8/2003	Ellion et al.
			6,632,091 B1	10/2003	Cise et al.
			D482,451 S	11/2003	Page et al.

(56)

References Cited

U.S. PATENT DOCUMENTS

6,640,999 B2	11/2003	Peterson	D608,430 S	1/2010	Slothower
6,647,577 B2	11/2003	Tam	7,670,141 B2	3/2010	Thomas et al.
6,659,674 B2	12/2003	Carlucci et al.	7,677,888 B1	3/2010	Halm
6,663,386 B1	12/2003	Moelsgaard	D613,550 S	4/2010	Picozza et al.
6,669,059 B2	12/2003	Mehta	D621,949 S	8/2010	Seki et al.
D484,971 S	1/2004	Hartwein	D622,928 S	9/2010	Griebel
6,681,418 B1	1/2004	Bierend	D623,376 S	9/2010	Griebel
D486,573 S	2/2004	Callaghan et al.	D625,105 S	10/2010	Winkler
6,689,078 B1	2/2004	Rehkemper et al.	D625,406 S	10/2010	Seki et al.
6,699,208 B2	3/2004	Bachman et al.	7,814,585 B1	10/2010	Reich
6,719,561 B2	4/2004	Gugel et al.	D626,647 S	11/2010	Amborn
D489,183 S	5/2004	Akahori et al.	D629,884 S	12/2010	Stephens
6,739,782 B1	5/2004	Rehkemper et al.	7,857,623 B2	12/2010	Grez
6,740,053 B2	5/2004	Kaplowitz	7,862,536 B2	1/2011	Chen et al.
D490,899 S	6/2004	Gagnon	7,959,597 B2	6/2011	Baker et al.
D491,728 S	6/2004	Jimenez	D640,872 S	7/2011	Nanda
D492,996 S	7/2004	Rehkemper et al.	D648,539 S	11/2011	Wai
6,761,324 B2	7/2004	Chang	D648,941 S	11/2011	Leung
6,766,549 B2	7/2004	Klupt	D651,409 S	1/2012	Papenfu
D495,142 S	8/2004	Berde	D651,805 S	1/2012	Hay
D495,143 S	8/2004	Berde	D653,340 S	1/2012	Goerge et al.
6,779,216 B2	8/2004	Davies et al.	8,113,832 B2	2/2012	Snyder et al.
6,783,004 B1	8/2004	Rinner	D655,380 S	3/2012	Taylor
6,783,505 B1	8/2004	Lai	D658,381 S	5/2012	Gebski
6,796,796 B2	9/2004	Segal	D658,538 S	5/2012	Korzeniowski
6,808,331 B2	10/2004	Hall et al.	8,220,726 B2	7/2012	Qiu et al.
D498,643 S	11/2004	Pryor	D666,912 S	9/2012	Kawai
6,814,259 B1	11/2004	Foster et al.	8,256,979 B2	9/2012	Hilscher et al.
D499,885 S	12/2004	Xi	D668,339 S	10/2012	Luoto
6,835,181 B2	12/2004	Hippensteel	D669,169 S	10/2012	Washington et al.
D500,599 S	1/2005	Callaghan	8,297,534 B2	10/2012	Li et al.
6,836,917 B2	1/2005	Blaustein et al.	D670,373 S	11/2012	Taylor et al.
6,837,708 B2	1/2005	Chen et al.	D670,958 S	11/2012	Picozza et al.
6,884,069 B2	4/2005	Goldman	D671,637 S	11/2012	Gebski et al.
6,902,337 B1	6/2005	Kuo	D672,018 S	12/2012	Bucher
6,907,879 B2	6/2005	Drinan et al.	8,366,024 B2	2/2013	Leber et al.
D509,585 S	9/2005	Kling et al.	8,403,577 B2	3/2013	Khoshnevis
D513,638 S	1/2006	Pan	8,403,665 B2	3/2013	Thomas et al.
D515,215 S	2/2006	Wang	8,408,483 B2	4/2013	Boyd et al.
D522,652 S	6/2006	Massey	8,418,300 B2	4/2013	Miller et al.
7,080,980 B2	7/2006	Klupt	D686,311 S	7/2013	Mori
D529,661 S	10/2006	Schmidt	D694,378 S	11/2013	Bates
D530,010 S	10/2006	Luetttgen et al.	D694,398 S	11/2013	Taylor
7,117,555 B2	10/2006	Fattori et al.	D700,343 S	2/2014	Liu
D532,570 S	11/2006	Vizcarra	D702,819 S	4/2014	Garland
7,131,838 B2	11/2006	Suzuki et al.	D702,821 S	4/2014	Garland
D533,720 S	12/2006	Vu	D707,350 S	6/2014	Woodard
7,147,468 B2	12/2006	Snyder et al.	D709,183 S	7/2014	Kemlein
D538,474 S	3/2007	Sheppard et al.	D714,929 S *	10/2014	Kim D24/111
D548,334 S	8/2007	Izumi	D714,930 S *	10/2014	Kim A61H 13/005 D24/111
D550,097 S	9/2007	Lepoitevin	D717,412 S	11/2014	Bucher
D553,980 S	10/2007	VerWeyst	D717,427 S	11/2014	Kim
7,276,035 B2	10/2007	Lu	D717,547 S	11/2014	Adriaenssen
7,314,456 B2	1/2008	Shaw	D718,855 S	12/2014	Kim et al.
D563,674 S	3/2008	Beedham	D719,737 S	12/2014	Adriaenssen
D565,175 S *	3/2008	Boyd D24/111	D723,387 S	3/2015	Fath
7,344,510 B1	3/2008	Yande	D725,770 S *	3/2015	Kim D24/111
D565,713 S	4/2008	Gao	D731,640 S	6/2015	Kim et al.
7,367,803 B2	5/2008	Egeresi	D735,305 S	7/2015	Obara
D574,952 S *	8/2008	Boyd D24/111	D740,936 S *	10/2015	Kim D24/111
7,414,337 B2	8/2008	Wilkinson et al.	D745,329 S	12/2015	Ong
D577,198 S	9/2008	Jimenez	D745,423 S	12/2015	Khattak
D577,814 S	9/2008	Seki et al.	D746,975 S	1/2016	Schenck
D581,279 S	11/2008	Oates	D747,464 S	1/2016	Taylor
7,455,521 B2	11/2008	Fishburne, Jr.	D754,330 S	4/2016	Kim et al.
7,469,440 B2	12/2008	Boland et al.	D756,122 S	5/2016	Taylor
D585,132 S	1/2009	Pukall	D764,051 S	8/2016	Wang
D588,262 S	3/2009	Pukall	D766,423 S	9/2016	Kim et al.
7,500,584 B2	3/2009	Schutz	D772,396 S	11/2016	Kim et al.
D590,492 S	4/2009	Powell	D772,397 S	11/2016	Kim et al.
D592,748 S	5/2009	Boulton	D773,822 S	12/2016	Sikora
D595,136 S	6/2009	Canamasas Puigbo	D774,651 S	12/2016	Kaib
D601,694 S	10/2009	Rocklin	D776,253 S	1/2017	Li
D601,697 S	10/2009	Sobeich et al.	D782,326 S	3/2017	Fath
D603,708 S	11/2009	Handy	D782,656 S	3/2017	Au
			D782,657 S	3/2017	Williams
			D786,422 S	5/2017	Au
			9,642,677 B2	5/2017	Luetttgen et al.

(56)

References Cited

U.S. PATENT DOCUMENTS

D788,907 S * 6/2017 Kim D24/111
 D798,059 S 7/2017 McGarry
 D798,440 S * 9/2017 Kim D24/111
 D799,217 S 10/2017 Masee
 D802,119 S * 11/2017 Kim D24/111
 D809,650 S * 2/2018 Kim D24/111
 2002/0090252 A1 7/2002 Hall et al.
 2002/0108193 A1 8/2002 Gruber
 2002/0119415 A1 8/2002 Bailey
 2002/0152565 A1 10/2002 Klupt
 2003/0060743 A1 3/2003 Chang
 2003/0098249 A1 5/2003 Rollock
 2003/0162146 A1 8/2003 Shortt et al.
 2003/0204155 A1 10/2003 Egeresi
 2003/0213075 A1 11/2003 Hui et al.
 2004/0045107 A1 3/2004 Egeresi
 2004/0076921 A1 4/2004 Gofman et al.
 2004/0122377 A1 6/2004 Fischer et al.
 2004/0126730 A1 7/2004 Panagotacos
 2004/0180569 A1 10/2004 Chiou
 2004/0209222 A1 10/2004 Snyder
 2005/0049620 A1 3/2005 Chang
 2005/0064371 A1 3/2005 Soukos et al.
 2005/0101894 A1 5/2005 Hippensteel
 2005/0102773 A1 5/2005 Obermann et al.
 2005/0144745 A1 7/2005 Russell
 2005/0177079 A1 8/2005 Pan
 2005/0271531 A1 12/2005 Brown et al.
 2006/0008373 A1 1/2006 Schutz
 2006/0010624 A1 1/2006 Cleland
 2006/0026784 A1 2/2006 Moskovich et al.
 2006/0057539 A1 3/2006 Sodo
 2006/0078844 A1 4/2006 Goldman et al.
 2006/0079818 A1 4/2006 Yande
 2006/0207052 A1 9/2006 Tran
 2007/0082316 A1 4/2007 Zhadanov et al.
 2007/0082317 A1 4/2007 Chuang
 2007/0113360 A1 5/2007 Tsai
 2007/0202459 A1 8/2007 Boyd et al.
 2007/0203439 A1 * 8/2007 Boyd A61C 1/0084
 601/162
 2007/0254260 A1 11/2007 Alden
 2008/0189951 A1 8/2008 Molema et al.
 2008/0213719 A1 9/2008 Giniger et al.
 2008/0253906 A1 10/2008 Strong
 2009/0070949 A1 3/2009 Sagel et al.
 2009/0071267 A1 3/2009 Mathus et al.
 2009/0082706 A1 3/2009 Shaw
 2009/0124945 A1 5/2009 Reich et al.
 2009/0139351 A1 6/2009 Reichmuth
 2009/0163839 A1 6/2009 Alexander
 2009/0188780 A1 7/2009 Watanabe
 2009/0281454 A1 11/2009 Baker et al.
 2010/0010524 A1 1/2010 Barrington
 2010/0015566 A1 1/2010 Shaw
 2010/0049177 A1 2/2010 Boone, III et al.
 2010/0190132 A1 7/2010 Taylor et al.
 2010/0239998 A1 9/2010 Snyder et al.
 2010/0261134 A1 10/2010 Boyd et al.
 2010/0261137 A1 10/2010 Boyd et al.
 2010/0326536 A1 12/2010 Nan
 2010/0330527 A1 12/2010 Boyd et al.
 2011/0027749 A1 2/2011 Syed
 2011/0076090 A1 3/2011 Wu et al.
 2011/0097683 A1 4/2011 Boyd et al.
 2011/0139826 A1 6/2011 Hair et al.
 2011/0144588 A1 6/2011 Taylor et al.
 2011/0184341 A1 7/2011 Baker et al.
 2011/0307039 A1 12/2011 Cornell
 2012/0021374 A1 1/2012 Cacka et al.
 2012/0045730 A1 * 2/2012 Sayder A61C 17/02
 433/29
 2012/0064480 A1 3/2012 Hegemann
 2012/0077145 A1 3/2012 Tsurukawa
 2012/0141952 A1 6/2012 Snyder et al.

2012/0179118 A1 7/2012 Hair
 2012/0189976 A1 7/2012 McDonough et al.
 2012/0266396 A1 10/2012 Leung
 2012/0277663 A1 11/2012 Millman et al.
 2012/0277677 A1 11/2012 Taylor et al.
 2012/0277678 A1 11/2012 Taylor et al.
 2012/0279002 A1 11/2012 Sokol et al.
 2012/0295220 A1 11/2012 Thomas et al.
 2013/0089832 A1 4/2013 Lee
 2013/0295520 A1 11/2013 Hsieh
 2014/0106296 A1 4/2014 Woodard et al.
 2014/0193774 A1 7/2014 Snyder et al.
 2014/0259474 A1 9/2014 Sokol et al.
 2014/0272769 A1 9/2014 Luetngen et al.
 2014/0272782 A1 * 9/2014 Luetngen A61H 13/005
 433/80
 2014/0352088 A1 12/2014 Wu
 2015/0004559 A1 1/2015 Luetngen et al.
 2015/0147717 A1 * 5/2015 Taylor A61C 17/0205
 433/80
 2015/0173850 A1 6/2015 Garrigues et al.
 2015/0182319 A1 * 7/2015 Wagner A61C 17/0202
 132/308
 2016/0100921 A1 4/2016 Ungar
 2016/0151133 A1 6/2016 Luetngen et al.
 2017/0049530 A1 * 2/2017 Cacka A61C 17/028
 2017/0239132 A1 * 8/2017 Luetngen A61H 13/005
 2017/0252251 A1 * 9/2017 Williams A61C 17/0202

FOREIGN PATENT DOCUMENTS

CN	204049908	12/2014
DE	1466963	5/1969
DE	2019003	11/1971
DE	2409752	9/1975
DE	2545936	4/1977
DE	2714876	10/1978
DE	2910982	2/1980
DE	3346651	7/1985
EP	0023672	7/1980
EP	0515983	2/1992
EP	1825827	8/2007
FR	2556954	6/1985
FR	2654627	5/1991
GB	838564	6/1960
GB	1182031	2/1970
GB	2018605	10/1979
JP	2-134150	5/1990
JP	2009-39455	2/2009
KR	20120126265	11/2012
WO	WO95/016404	6/1995
WO	WO01/10327	2/2001
WO	WO04/021958	3/2004
WO	WO04/039205	5/2004
WO	WO2004/060259	7/2004
WO	WO2004/062518	7/2004
WO	WO2008/070730	6/2008
WO	WO2008/157585	12/2008
WO	WO2013/124691	8/2013

OTHER PUBLICATIONS

Waterpik ADA Accepted WP-663, posted at amazon.com, earliest date reviewed on Feb. 6, 2014, [online], acquired on Feb. 12, 2018. Available from Internet, <URL: https://www.amazon.com/Waterpik-Accepted-WP-663-Aquarius-Flosser/dp/B072JFVXSY/ref=cm_cr_arp_d_product_top?ie=UTF8&th=1> (Year: 2014).*

AliExpress. Date reviewed: Jan. 12, 2017. <<https://www.aliexpress.com/item/Cordless-Water-Floss-Portable-Oral-Irrigator-Dental-Water-Flosser-Waterpic-Whatpick-Dental-Water-Pic-Whater-Pick/32769416341.html?spm=2114.40010308.4.75.Owuzfj>>.

The Right Tool, Electron Fusion Devices, Inc., 2 pages, at least as early as Feb. 1991.

Japanese Packaging, 2 pages, at least as early as Dec. 2002.

Japanese Instruction Brochure, 20 pages, at least as early as Dec. 2002.

(56)

References Cited

OTHER PUBLICATIONS

Brochure: Woog International, "You have a 98% chance of getting gum disease. Unless you read this.", Lancaster, Pennsylvania, 5 pages, Feb. 1987.

Brochure: Woog International, "We put the control of home dental care back into the hands of the professional", Lancaster, Pennsylvania, 2 pages, Feb. 1987.

Brochure: Woog International, "Products at a Glance: Home Dental Care System" Woog Orajel, 3 pages, at least as early as Dec. 18, 1998.

Website: http://www.just4teeth.com/product/Panasonic/Panasonic_Portable_Irrigator.htm, 2 pages, at least as early as Jun. 20, 2003.

Website: http://www.videodirectstore.com/store/merchant.mv?Screen=PROD&Product_Code=EW1'..., 2 pages, at least as early as Jun. 20, 2003.

Website: <http://products.consumerguide.com/cp/family/review/index.cfm/id/18742>, 2 pages, at least as early as Jun. 20, 2003.

Website: <http://www.racekarteng.com/images/walbroparts.gif> and <http://www.muller.net/mullermachine/docs/walbro1.html>, 4 pages, at least as early as Jun. 20, 2003.

European Search Report, EPO Application No. 07250799.9, Jul. 5, 2007.

European Search Report, EPO Application No. 07252693.2, 14 pages, Apr. 28, 2008.

European Examination Report, EPO Application No. 07250799.9, Feb. 5, 2009.

International Search Report, Application No. PCT/US2010/028180, 2 pages, May 18, 2010.

International Search Report, PCT/US2010/060800, 2 pages, Feb. 11, 2011.

International Search Report, PCT/US2011/052795, 10 pages, Jan. 17, 2012.

Waterpik SinuSense Website: <http://www.insightsbyapril.com/2012/03/waterpik-natural-remedy-for-sinus.html>, 8 pages, retrieved on May 31, 2012.

Website: <https://www.waterpik.com/about-us/>, 3 pages.

Waterpik WP350W Oral Irrigator. Dentist.net. Copyright date 2013. Date accessed: Mar. 30, 2017, 2 pages.

iPik Portable Oral Irrigator. AliExpress. Date reviewed: Oct. 5, 2016. https://www.aliexpress.com/...e-Oral-Care-Product-Nasal-Irrigator-Tooth-Flosser-Water/1525541997.html?aff_platform=aaf&cpt=1490913714609&sk=yfAeyJa&aff_trace_key=c5a300c4f02e46d08c042f5292e1762f-1490913714609-07517-yfAeyJa, 18 pages.

Brite Leafs Professional Portable 2-in-1 Nasal Sinus & Oral Irrigator. Brite Leafs. Copyright date 2012, <http://www.briteleafs.com/product6.html>, 1 page.

Suvo. "Helical Gears vs Spur Gears—Advantages and Disadvantages Compared." BrightHub Engineering, Aug. 18, 2010, www.brighthubengineering.com/manufacturing-technology/33535-helical-gears-vs-spur-gears/, 7 pages.

Waterpik Classic Professional Water Flosser, WP-72, posted at amazon.com, earliest date reviewed on Mar. 5, 2016, [online], acquired on Feb. 23, 2018. Available from Internet, <URL: https://www.amazon.com/Waterpik-Classic-Professional-Flosser-WP-72/dp/B00HFQQOU6/ref=cm_cr_ar_p_d_product_top?ie=UTF8> (Year: 2016).

Waterpik Complete Care 5.0 Toothbrush, posted at amazon.com, earliest date reviewed on Mar. 14, 2016, [online], acquired on Feb. 23, 2018. Available from Internet, <URL: https://www.amazon.com/Waterpik-Complete-Toothbrush-Water-Flosser/dp/B01CRZ939Y/ref=cm_cr_ar_p_d_product_top?ie=UTF8> (Year: 2016).

* cited by examiner

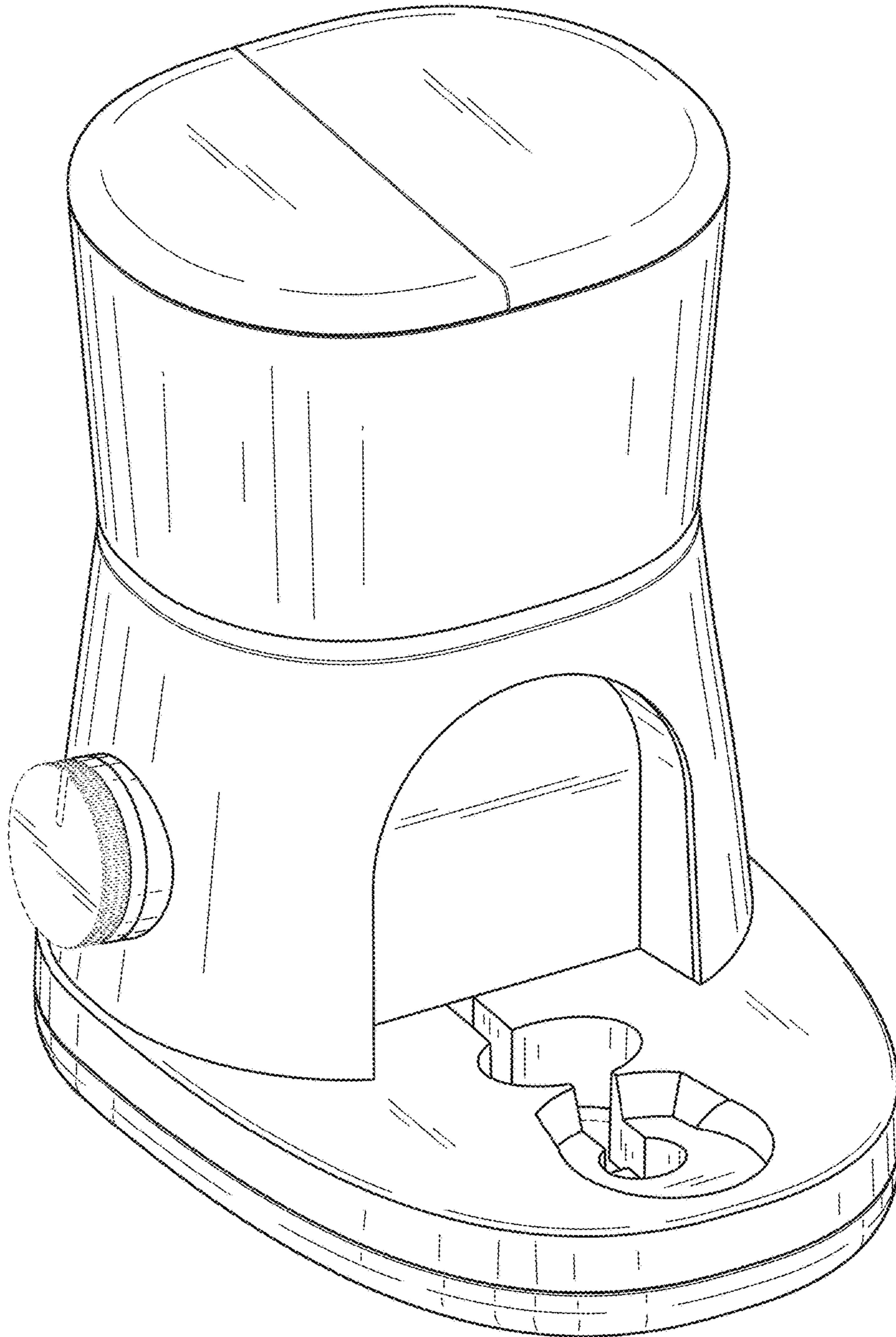

FIG. 1

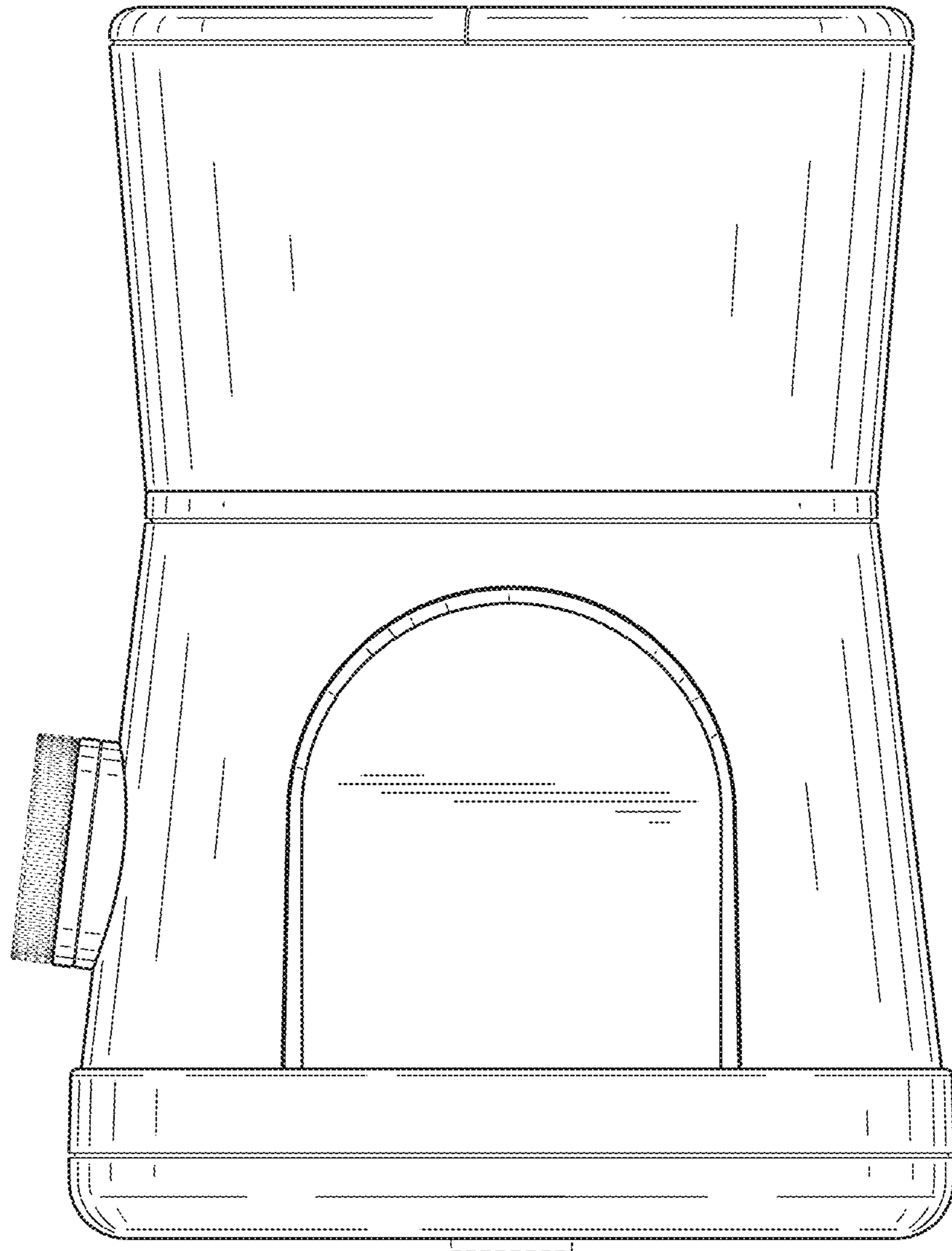

FIG. 2

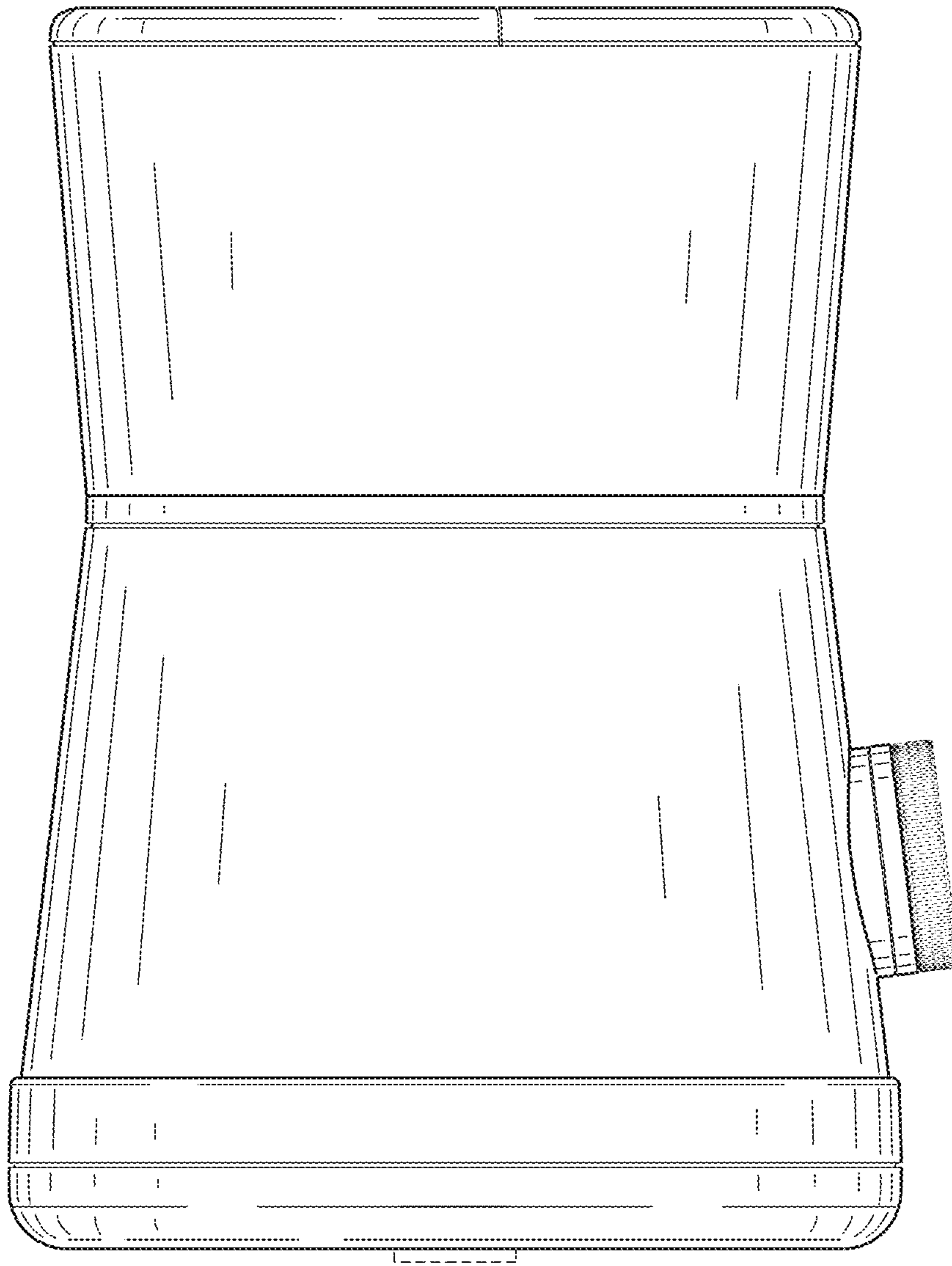

FIG. 3

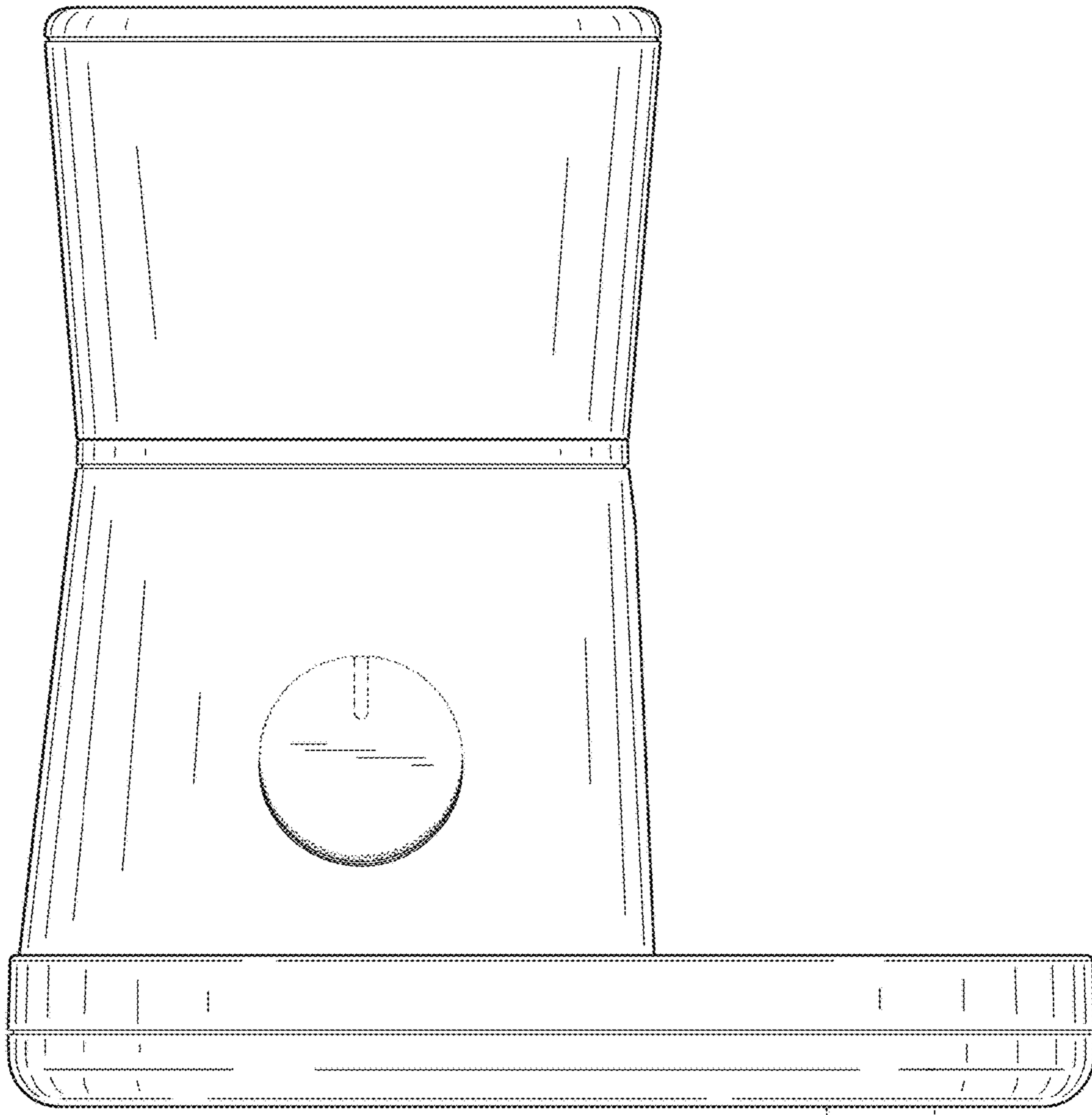

FIG. 4

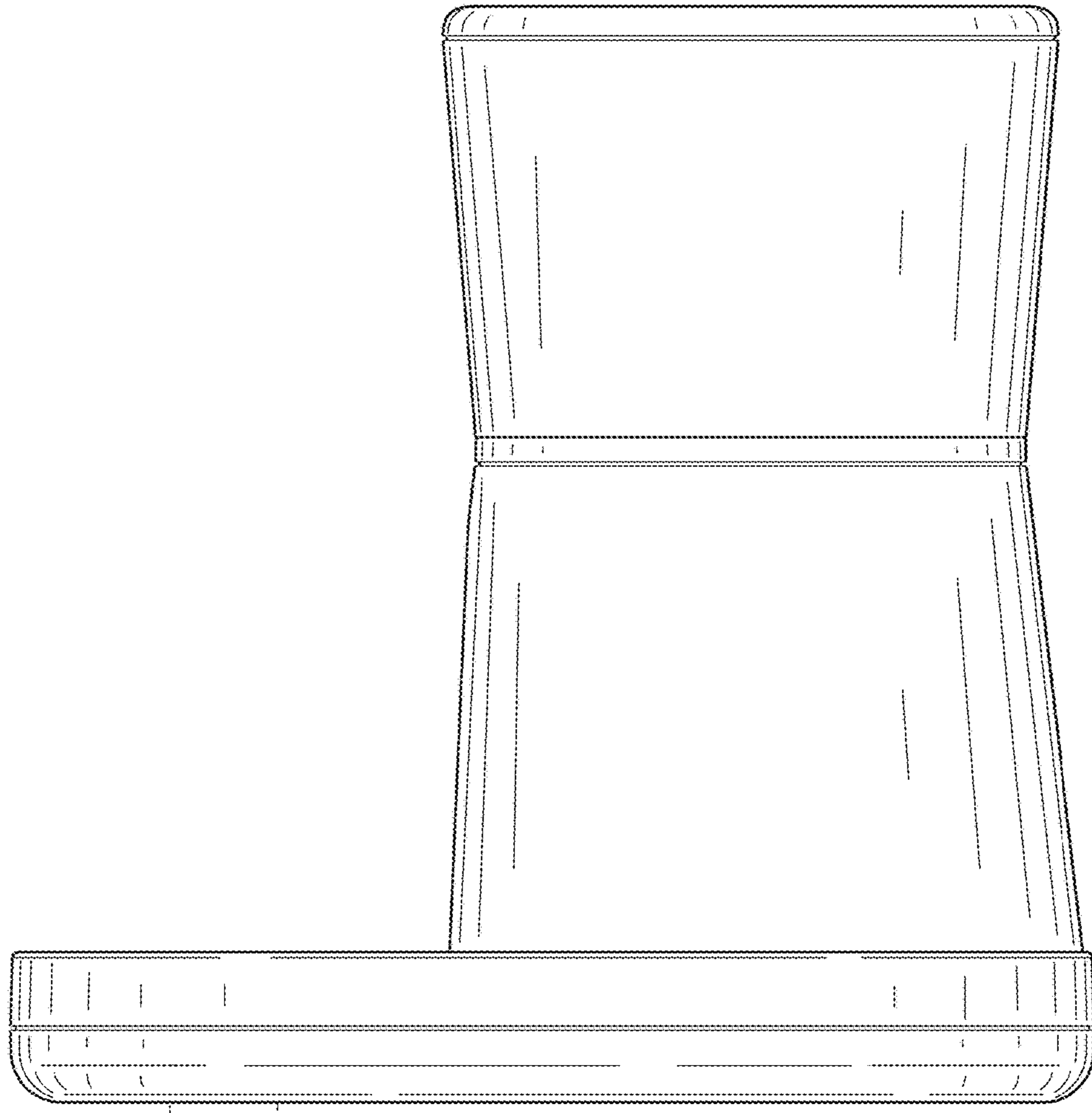

FIG. 5

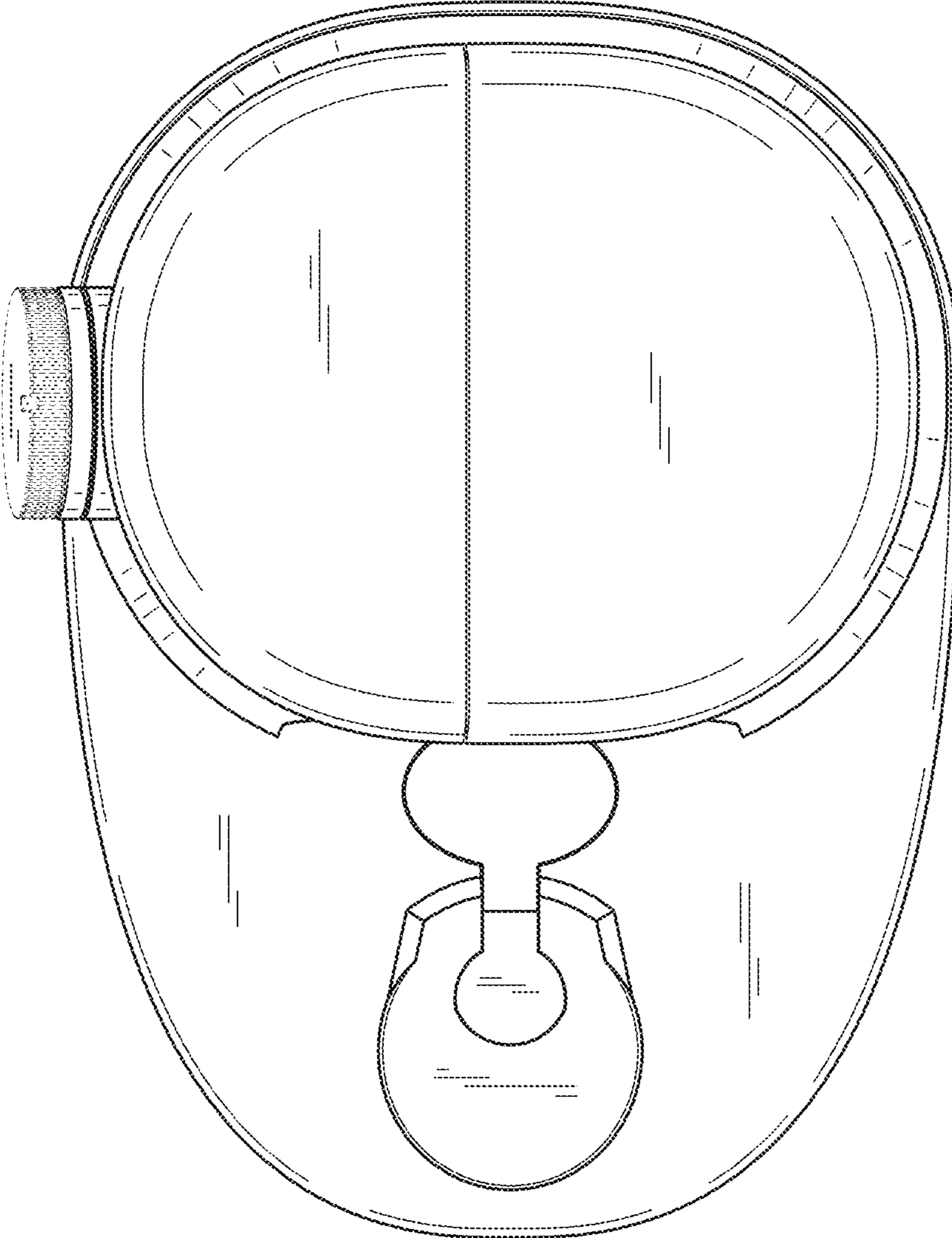

FIG. 6

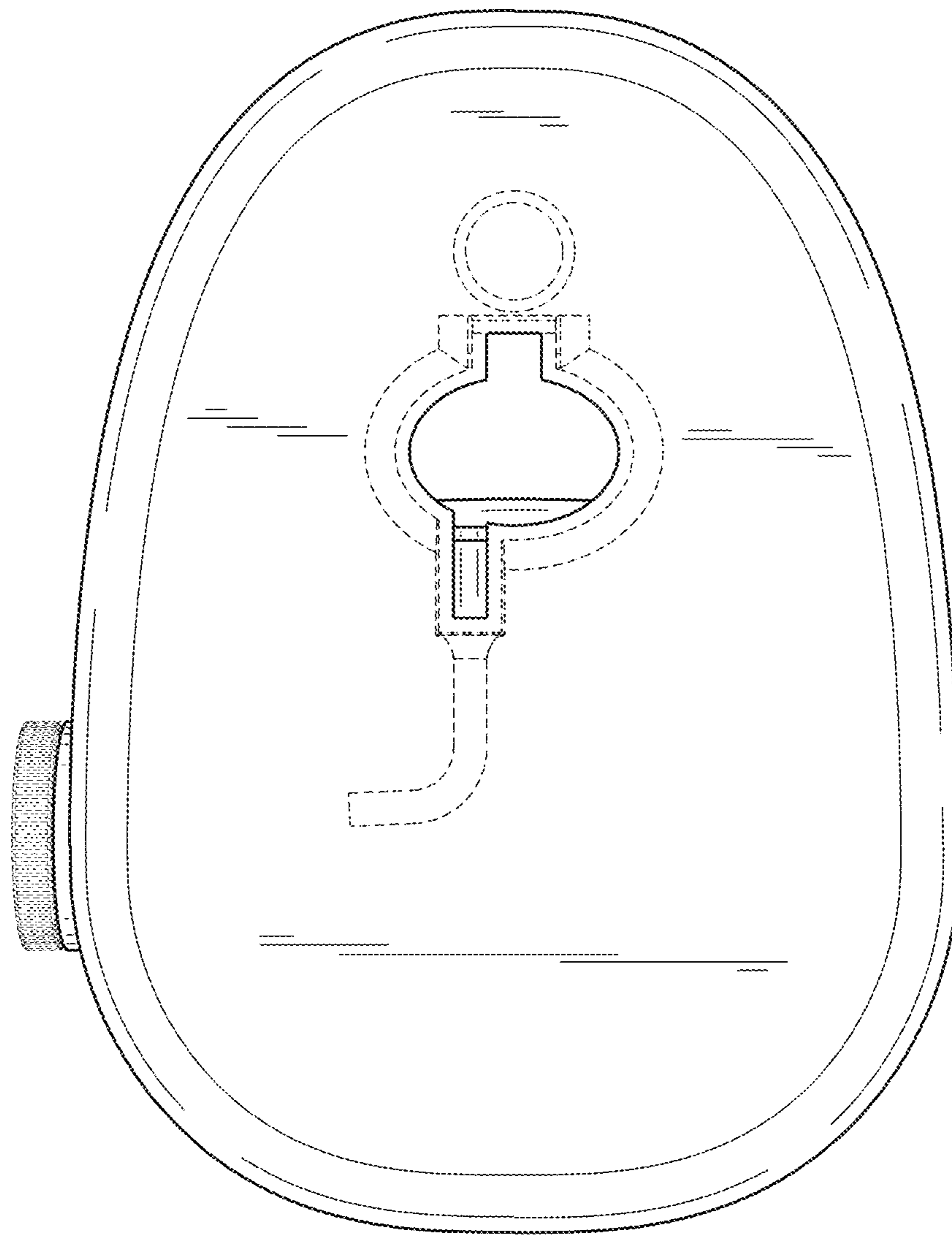

FIG. 7

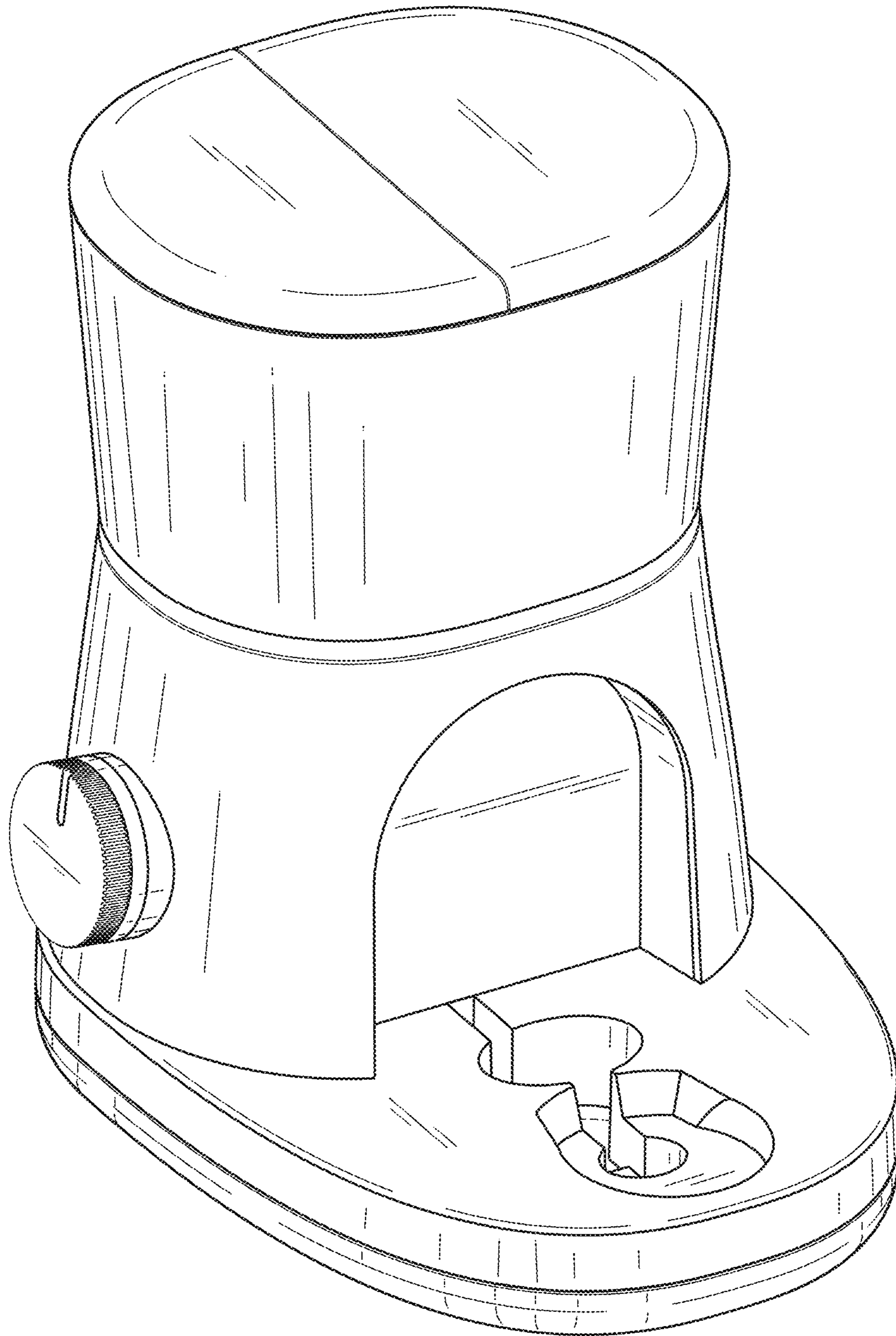

FIG. 8

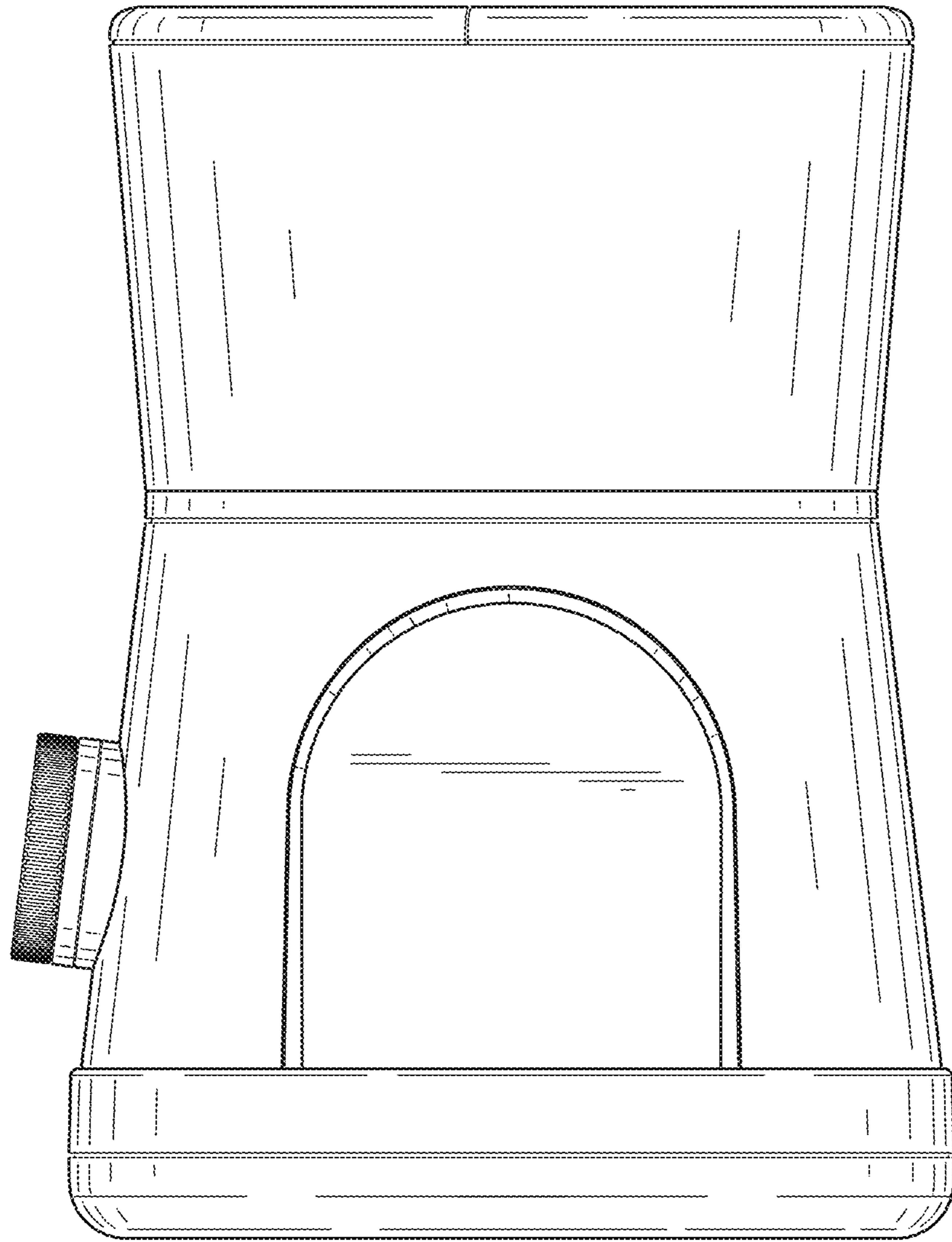

FIG. 9

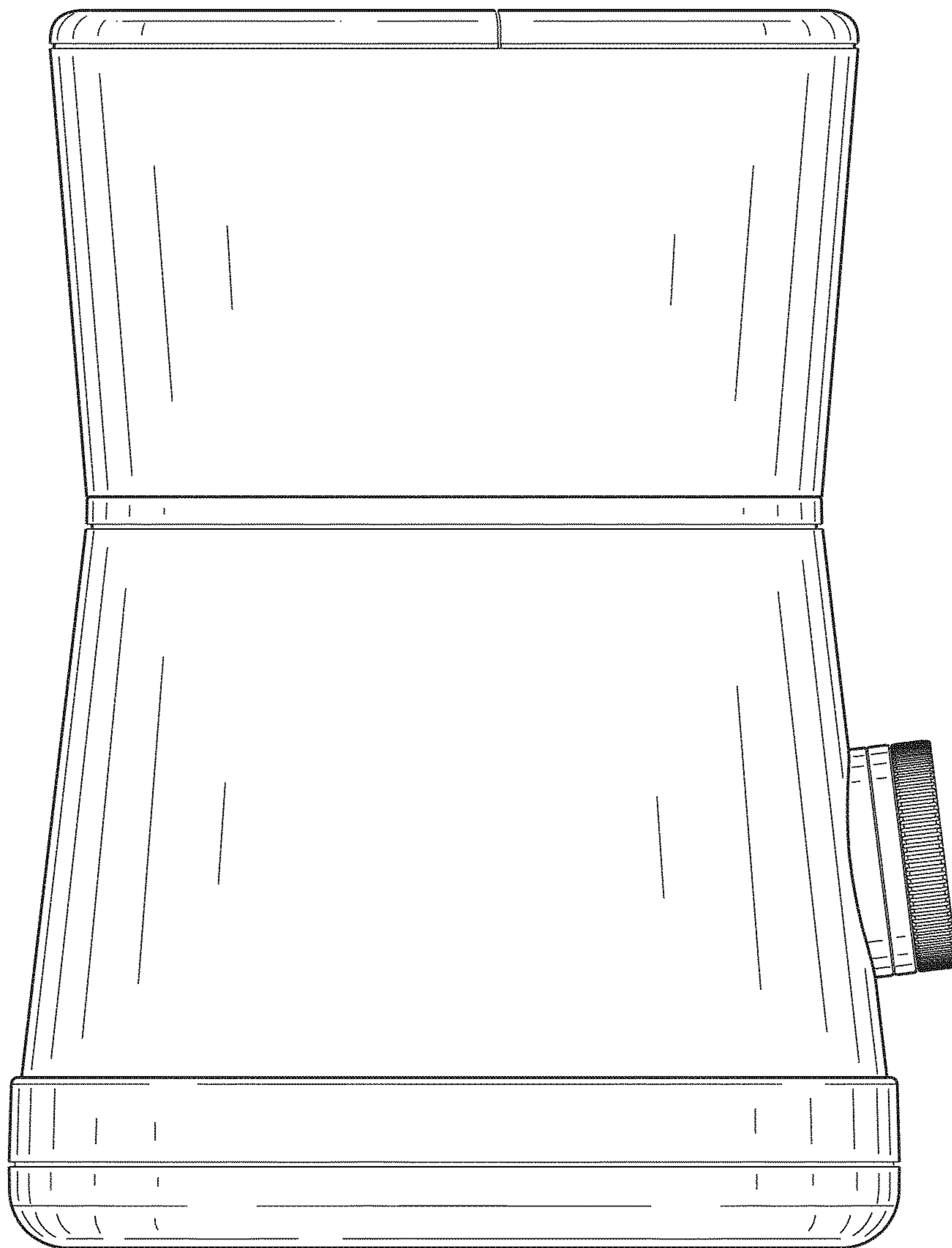

FIG. 10

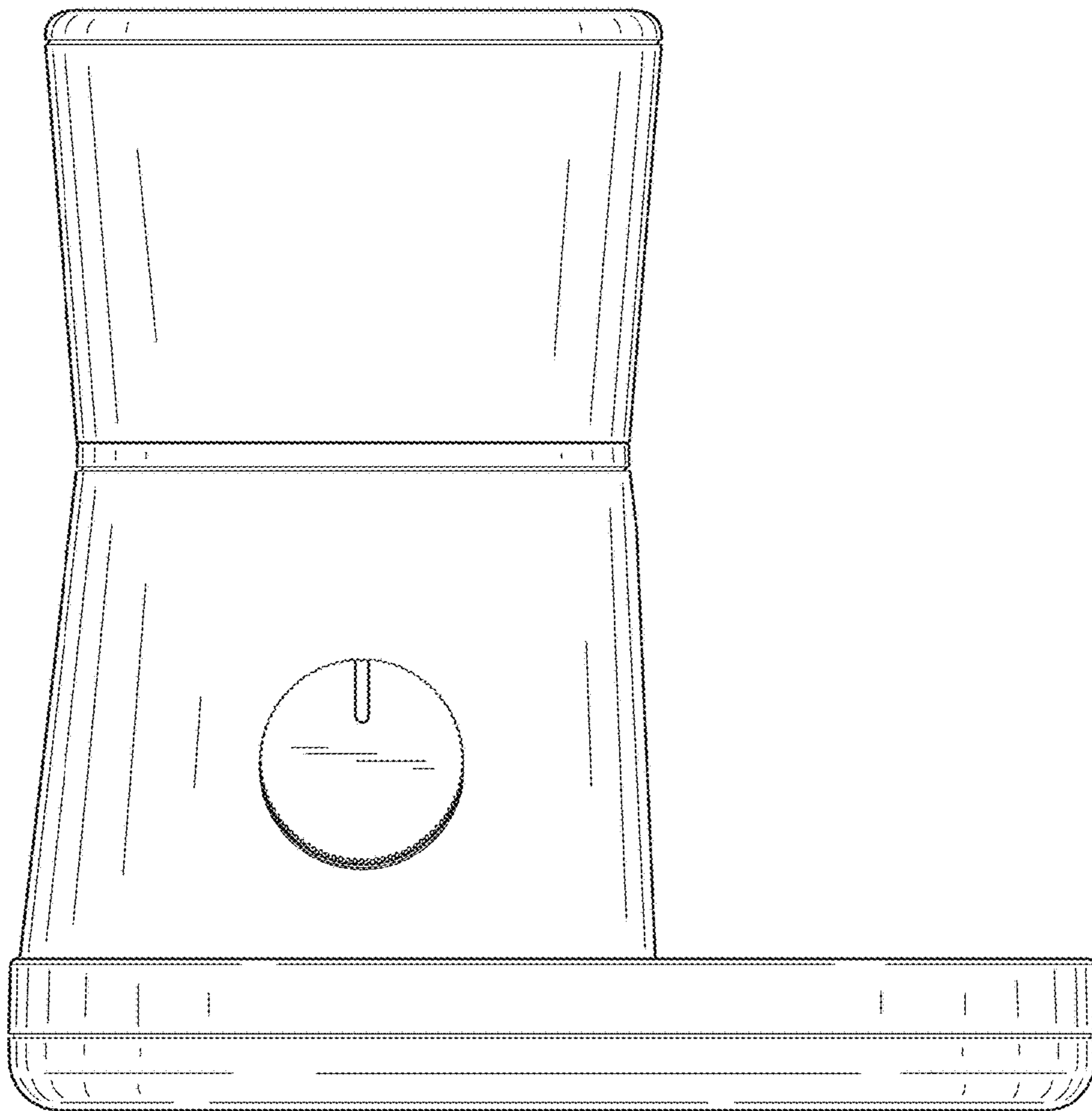

FIG. 11

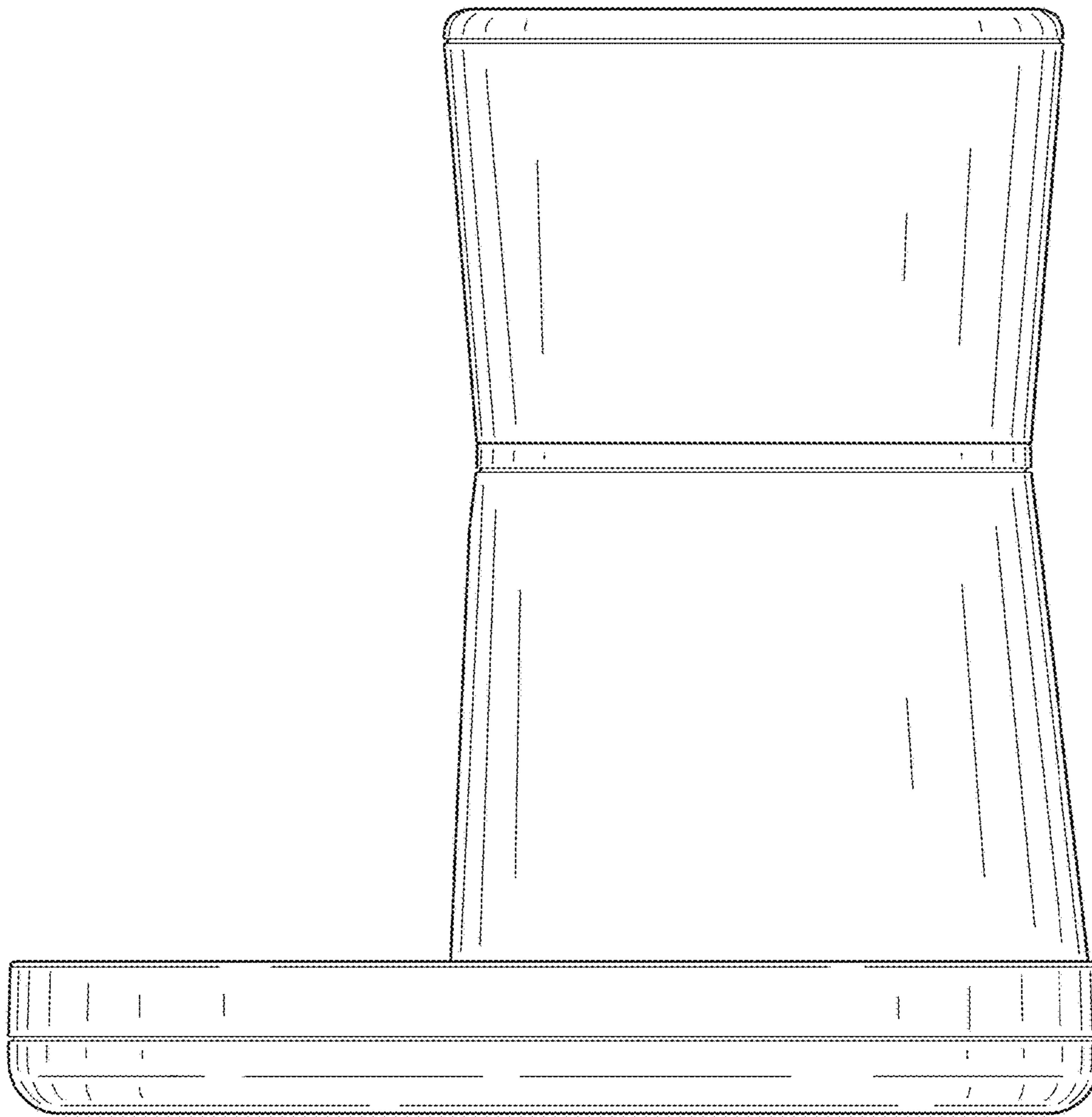

FIG. 12

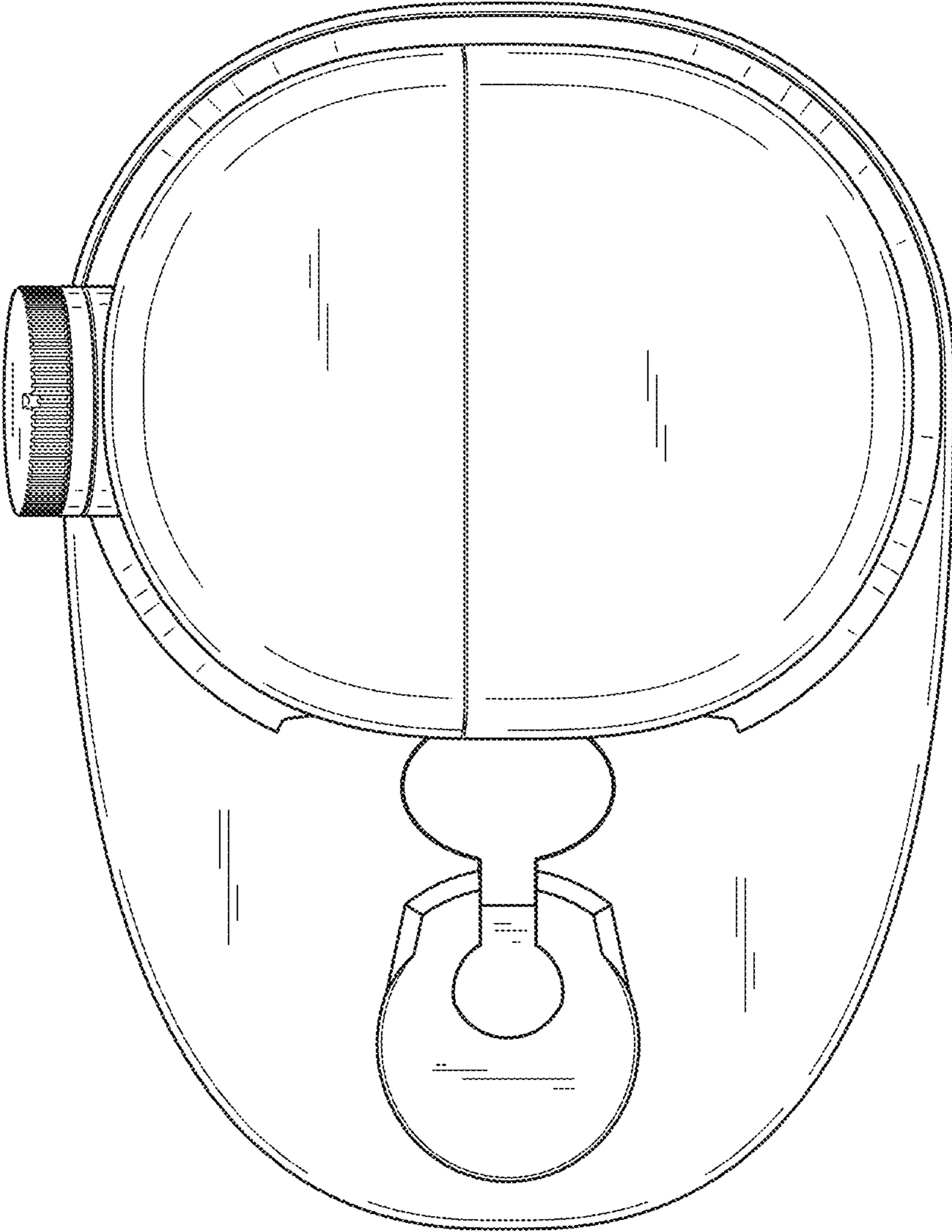

FIG. 13

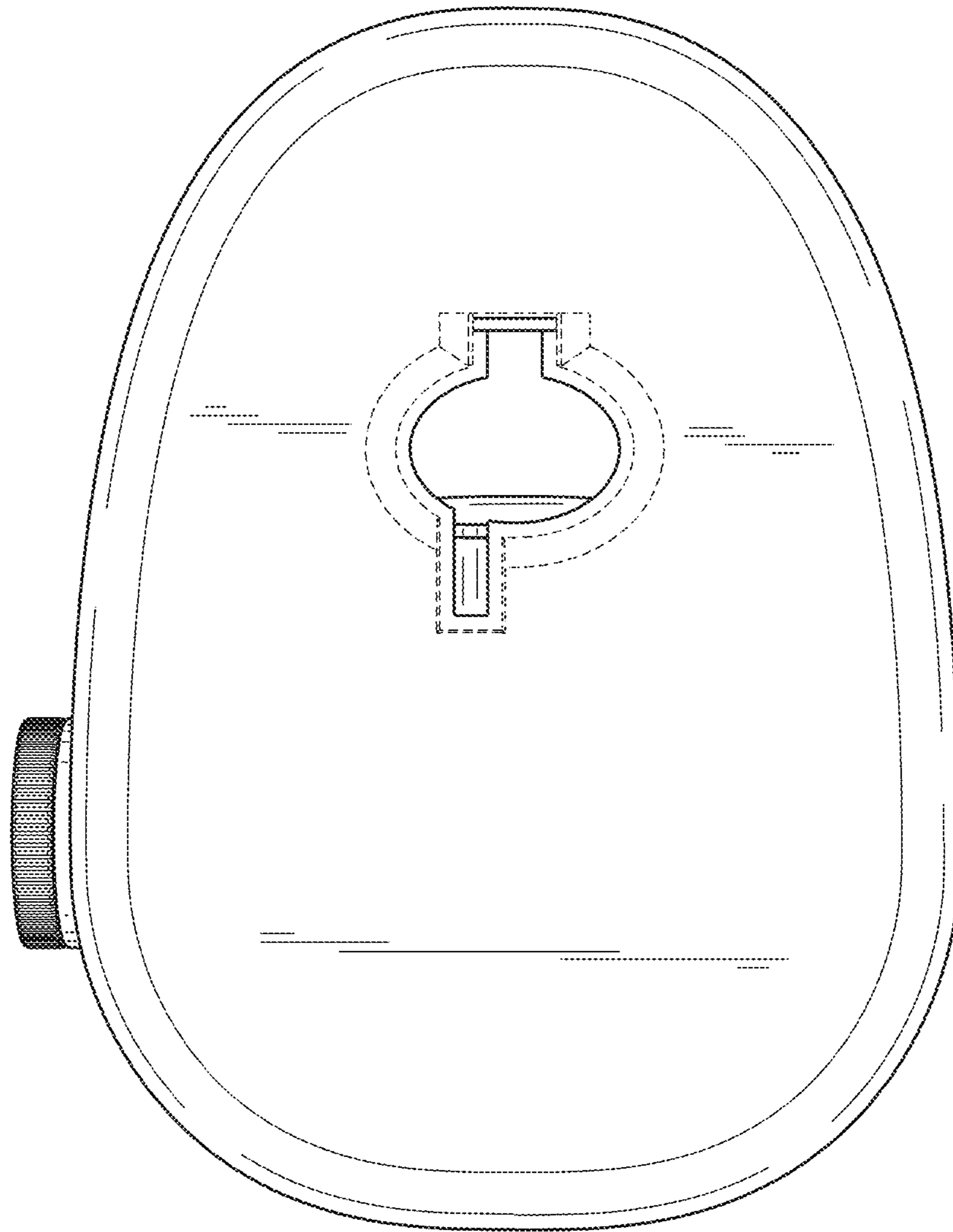

FIG. 14