



US00D839397S

(12) **United States Design Patent**  
**Whitehead**

(10) **Patent No.:** **US D839,397 S**  
(45) **Date of Patent:** **\*\* Jan. 29, 2019**

(54) **OVERFLOW CAP**

(71) Applicant: **IPS Corporation**, Collierville, TN (US)

(72) Inventor: **James H. Whitehead**, Collierville, TN (US)

(73) Assignee: **IPS CORPORATION**, Collierville, TN (US)

(\*\*) Term: **15 Years**

(21) Appl. No.: **29/596,009**

(22) Filed: **Mar. 3, 2017**

**Related U.S. Application Data**

(63) Continuation-in-part of application No. 15/179,355, filed on Jun. 10, 2016.

(51) **LOC (11) Cl.** ..... **23-01**

(52) **U.S. Cl.**  
USPC ..... **D23/260**

(58) **Field of Classification Search**  
USPC ..... D23/259-261, 267-268, 388, 397, 400, D23/406; 404/2-4; 210/163-164, 166;  
(Continued)

(56) **References Cited**

**U.S. PATENT DOCUMENTS**

1,375,222 A \* 4/1921 Lutz ..... E03C 1/262  
138/89

3,495,280 A 2/1970 Galbiati  
(Continued)

**FOREIGN PATENT DOCUMENTS**

CA 1 246 302 12/1988  
CA 1 253 654 5/1989

(Continued)

**OTHER PUBLICATIONS**

WatcoFlex® (Specifications) WATCO Manufacturing Company (Mar. 2009) 2 pages.

*Primary Examiner* — Eric L Goodman

*Assistant Examiner* — Amy C Wierenga

(74) *Attorney, Agent, or Firm* — Womble Bond Dickinson (US) LLP

(57) **CLAIM**

The ornamental design for an overflow cap, shown and described.

**DESCRIPTION**

FIG. 1 is a perspective view of a first embodiment of an overflow cap according to my new design; FIG. 2 is another perspective view thereof; FIG. 3 is a front elevation view thereof; FIG. 4 is a rear elevation view thereof; FIG. 5 is a left side elevation view thereof, the opposite, right side being a mirror image thereof; FIG. 6 is a top plan view thereof; FIG. 7 is a bottom plan view thereof; FIG. 8 is a cross-sectional view thereof taken along cut lines 8-8 in FIG. 3; FIG. 9 is a perspective view of a second embodiment of an overflow cap according to my new design; FIG. 10 is another perspective view thereof; FIG. 11 is a front elevation view thereof; FIG. 12 is a rear elevation view thereof; FIG. 13 is a left side elevation view thereof, the opposite, right side being a mirror image thereof; FIG. 14 is a top plan view thereof; FIG. 15 is a bottom plan view thereof; FIG. 16 is a cross-sectional view thereof taken along cut lines 16-16 in FIG. 11; FIG. 17 is a perspective view of a third embodiment of an overflow cap according to my new design; FIG. 18 is another perspective view thereof; FIG. 19 is a front elevation view thereof; FIG. 20 is a rear elevation view thereof; FIG. 21 is a left side elevation view thereof, the opposite, right side being a mirror image thereof; FIG. 22 is a top plan view thereof; FIG. 23 is a bottom plan view thereof; and, FIG. 24 is a cross-sectional view thereof taken along cut lines 24-24 in FIG. 19.

(Continued)

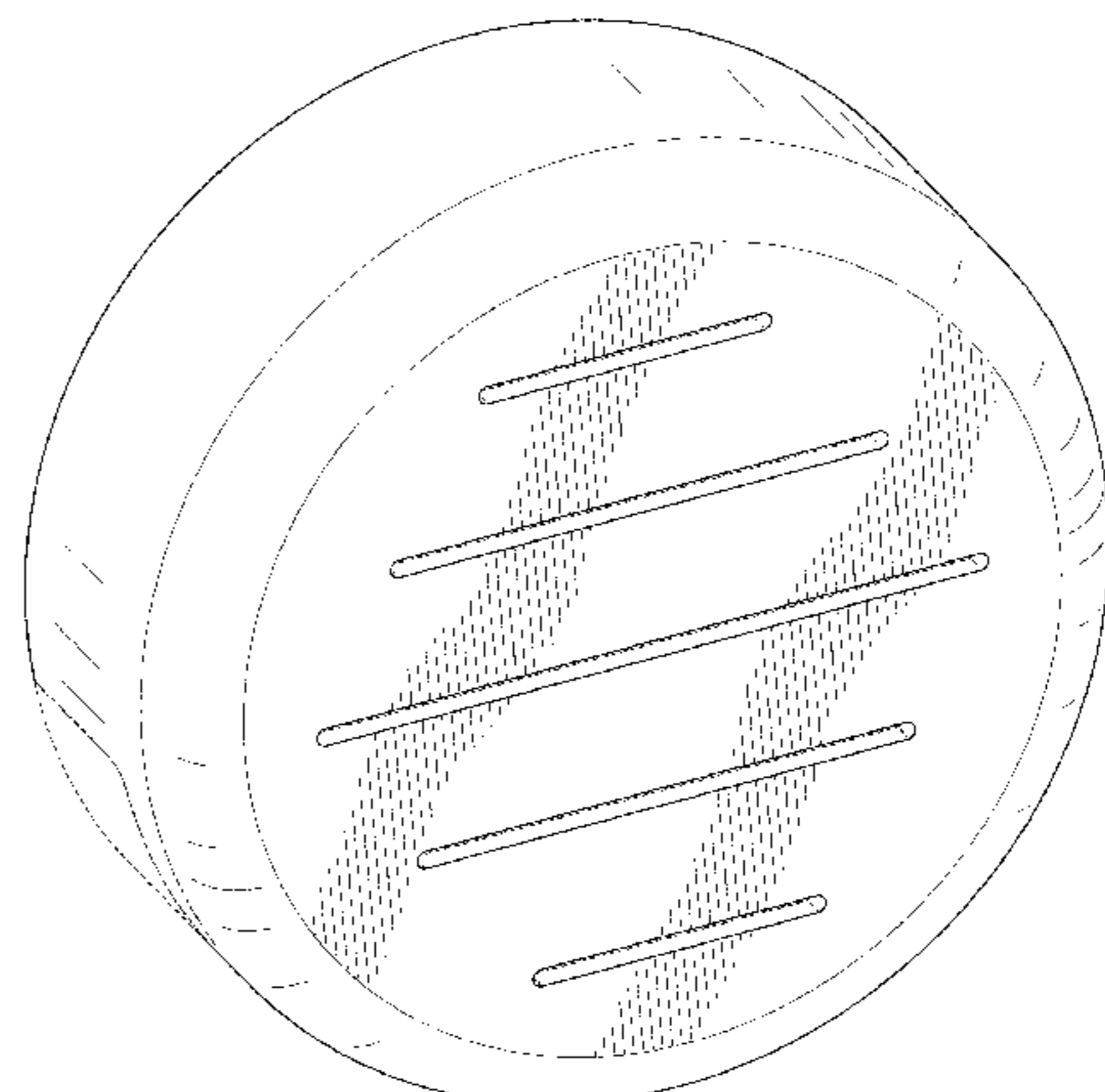
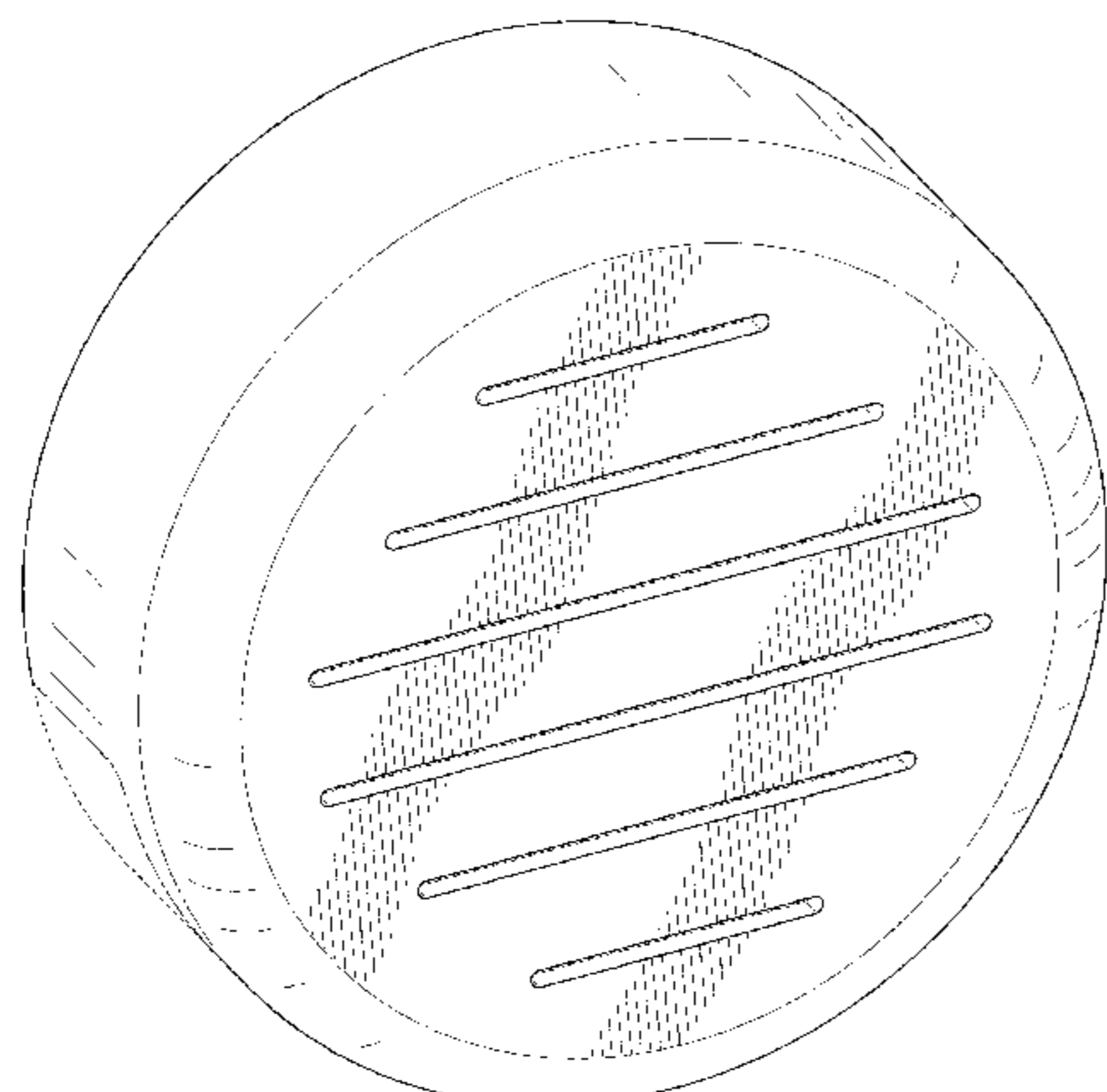

The broken lines showing in the views illustrate portions of the overflow cap that form no part of the claimed design. Any shading and cross-hatching are not features of the design but are utilized to illustrate the surface contours of the design.

The dash-dot-dash broken lines illustrate boundaries and form no part of the claim.

**1 Claim, 21 Drawing Sheets**

(58) **Field of Classification Search**

USPC .... 454/275-277, 284, 289, 291; 4/613, 287, 4/679, 680-684, 689-694, 671-673; D9/454  
 CPC .... E03C 1/12; E03C 1/20; E03C 1/23; E03C 1/26; E03C 1/262; E03C 1/284; E03C 1/2302; E03C 1/2306; E03C 1/2001; E03C 1/2413; E03C 2001/2413; E03F 5/0408; E03F 5/06; E03F 5/00407; E03F 5/052; A47K 1/14; A47K 3/405; A47K 3/40

See application file for complete search history.

(56) **References Cited**

U.S. PATENT DOCUMENTS

D254,928 S \* 5/1980 Mathis ..... D23/261  
 4,720,877 A 1/1988 Watts  
 D305,455 S \* 1/1990 Stairs, Jr. .... D23/254

D317,817 S \* 6/1991 Stairs, Jr. .... D23/254  
 5,179,740 A 1/1993 Marsilio et al.  
 6,073,278 A \* 6/2000 Ball ..... E03C 1/24  
 4/694  
 6,138,298 A \* 10/2000 Ball ..... E03C 1/24  
 4/694  
 6,216,288 B1 \* 4/2001 Bernau ..... E03C 1/24  
 4/680  
 6,681,420 B1 1/2004 Ball  
 D501,244 S \* 1/2005 Bantz ..... D23/261  
 D673,656 S \* 1/2013 Feliciano ..... D23/261  
 D682,995 S \* 5/2013 Feliciano ..... D23/261  
 D682,996 S \* 5/2013 Feliciano ..... D23/261  
 D683,436 S \* 5/2013 Feliciano ..... D23/261  
 8,621,683 B2 1/2014 Coronado et al.  
 8,671,473 B1 3/2014 Morrone  
 2004/0034926 A1 2/2004 Ball  
 2006/0085907 A1 4/2006 Ball  
 2008/0196161 A1 8/2008 Ball  
 2017/0356174 A1 \* 12/2017 Humber ..... E03C 1/244

FOREIGN PATENT DOCUMENTS

CN 2012 41358 Y 5/2009  
 DE 2 054 145 11/1970  
 EP 0 691 438 A2 1/1996  
 EP 1 826 323 A2 8/2007  
 FR 2 558 187 A1 7/1985  
 FR 2 739 115 A1 3/1997  
 FR 2 799 777 A1 4/2001  
 GB 1 216 208 12/1970  
 JP 2006-063515 A 3/2006  
 JP 2012-241488 A 12/2012  
 NZ 241770 A 7/1995

\* cited by examiner

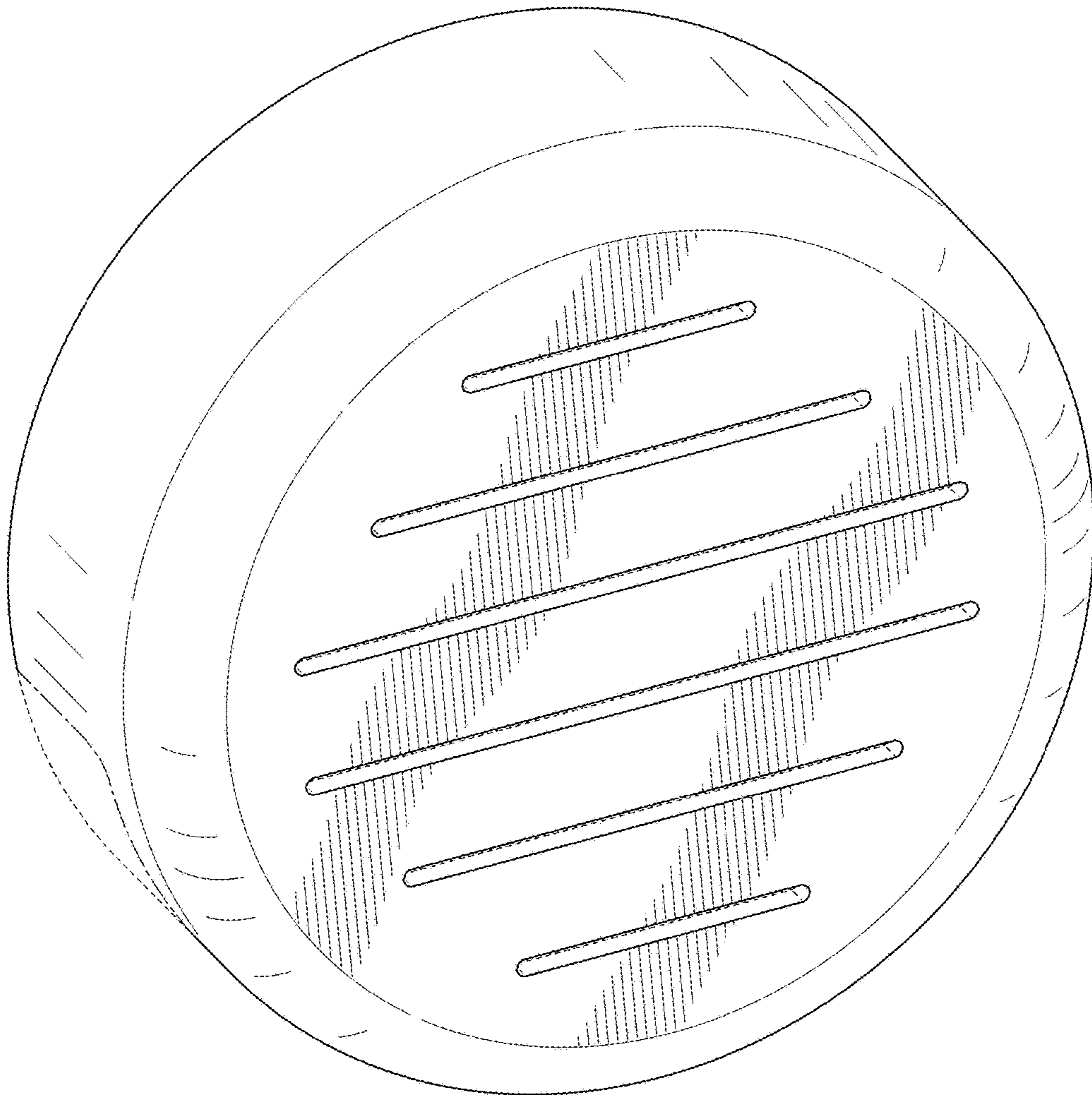

FIG. 1

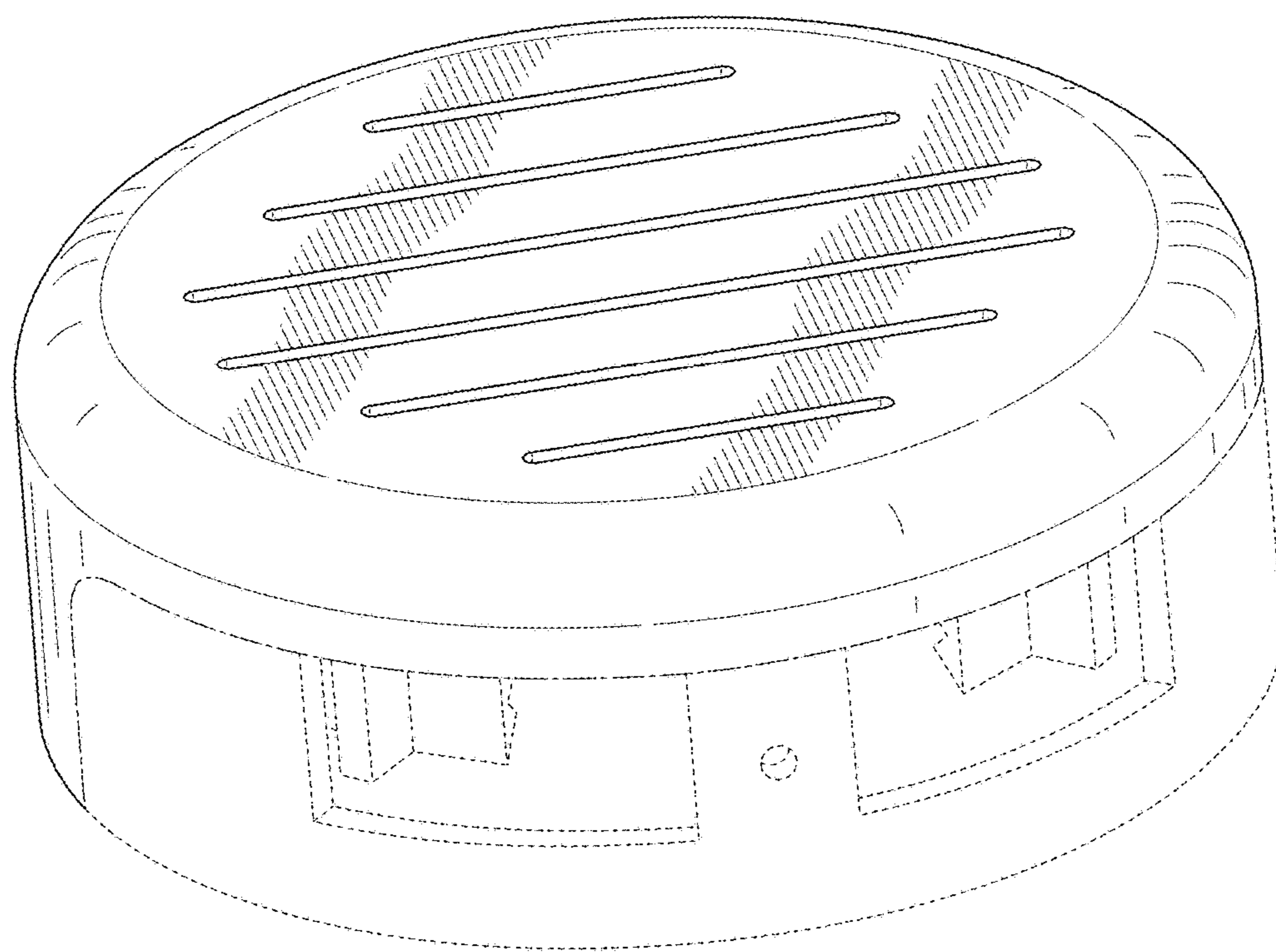

FIG. 2

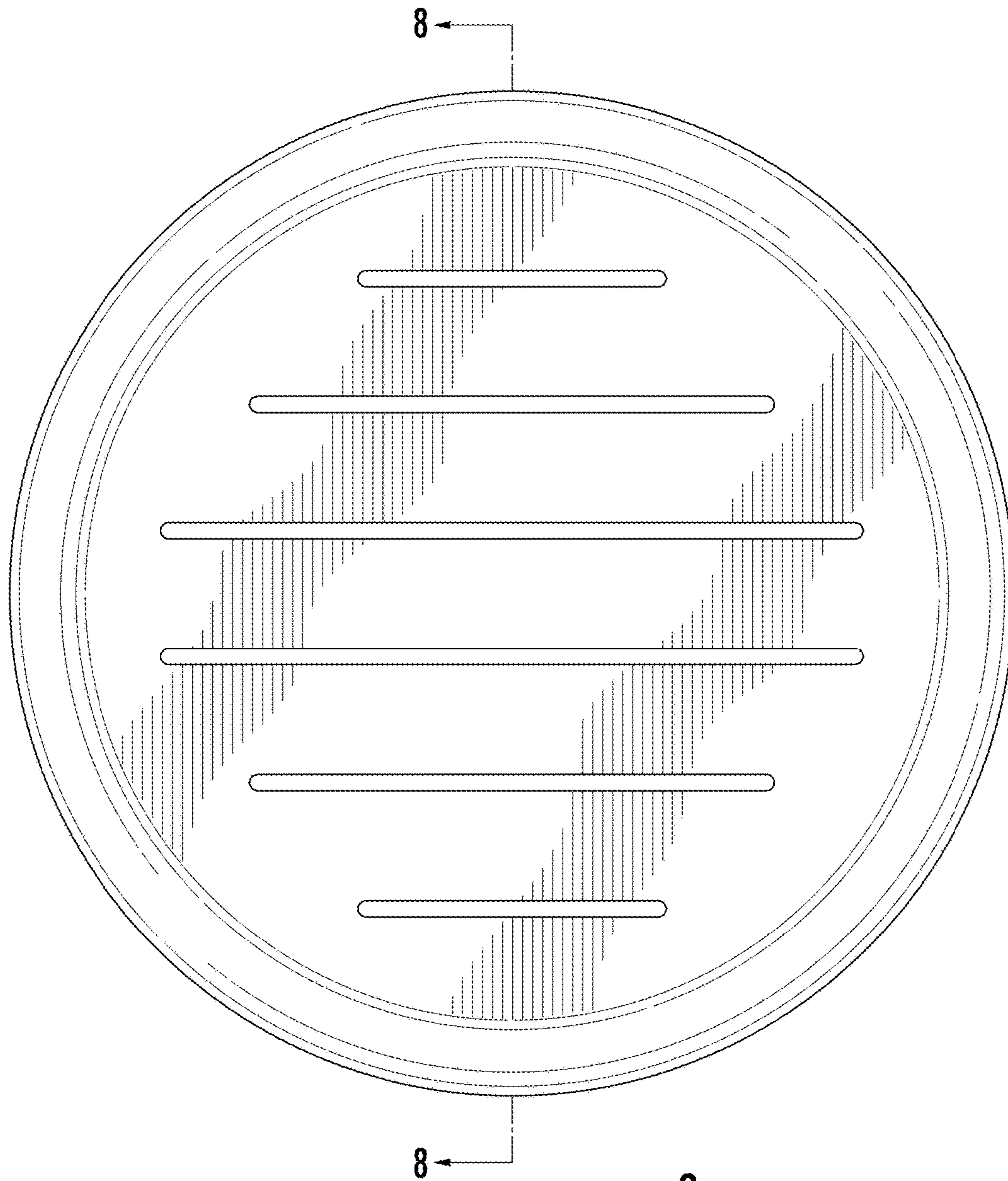

FIG. 3

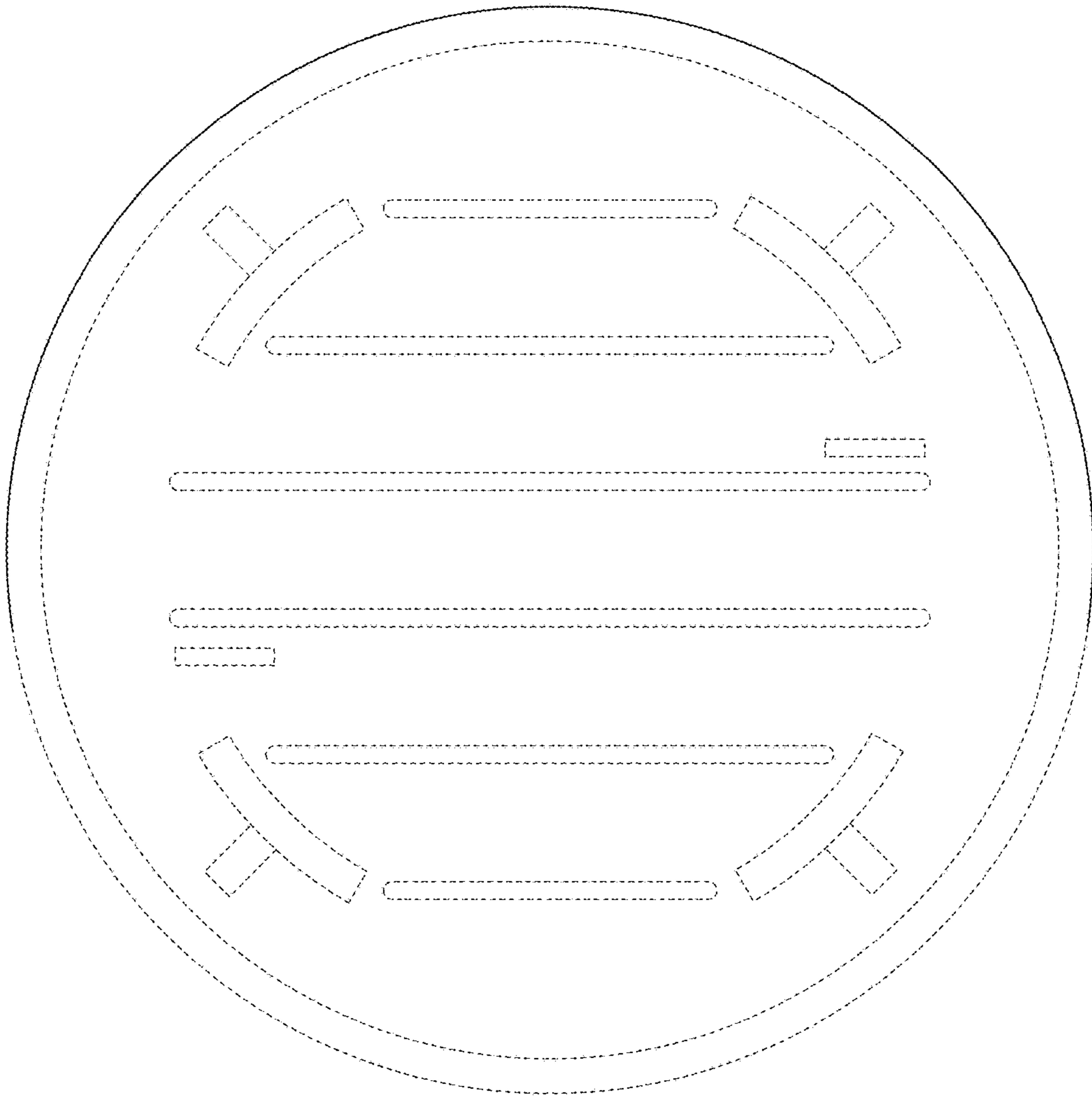
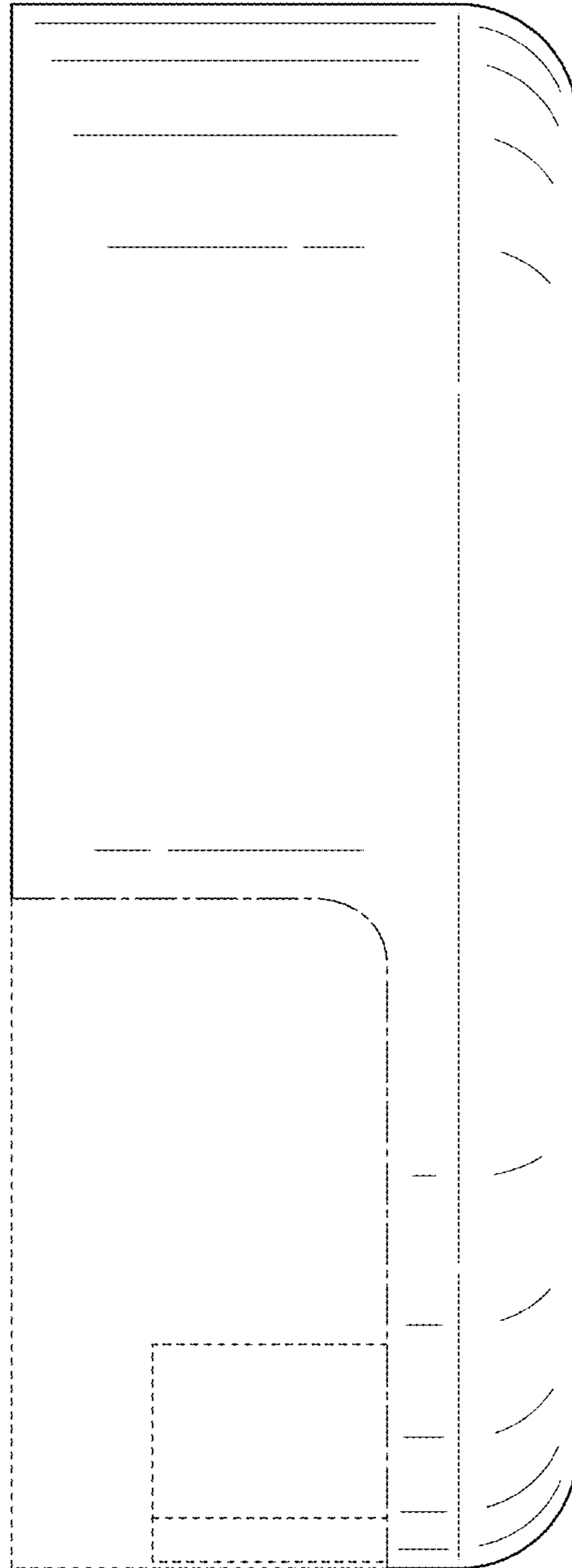

FIG. 4



**FIG. 5**

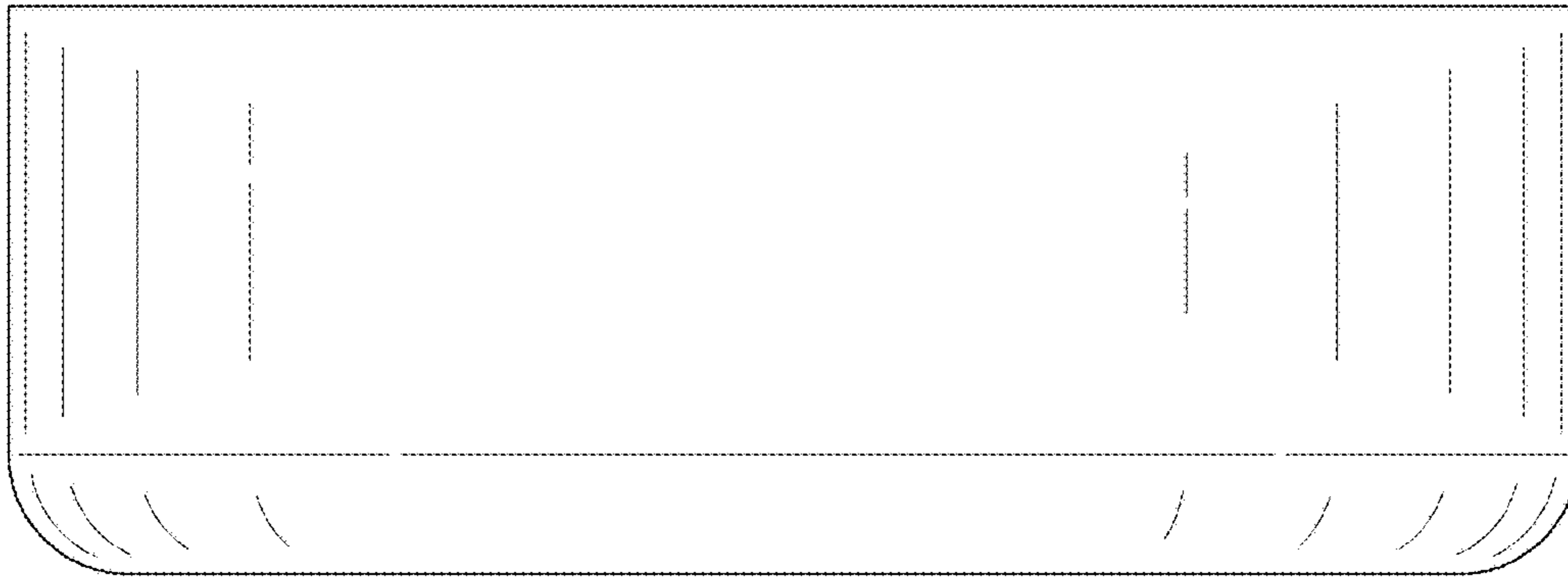

FIG. 6

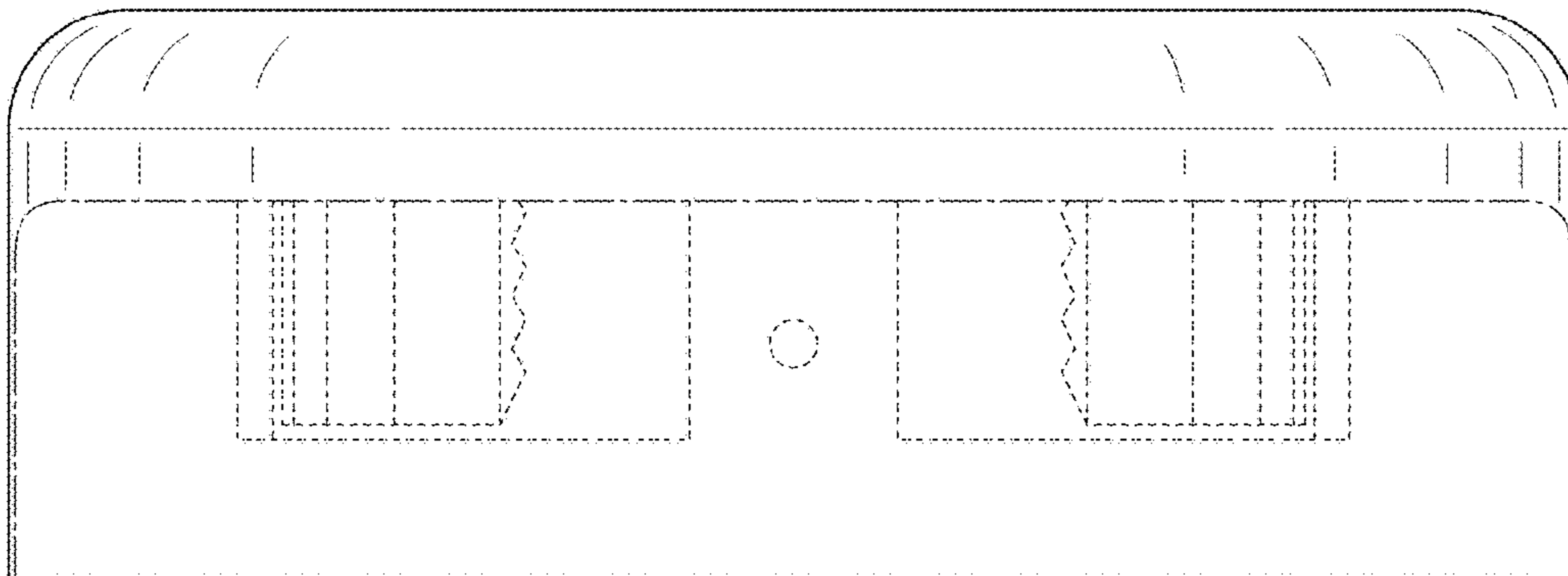
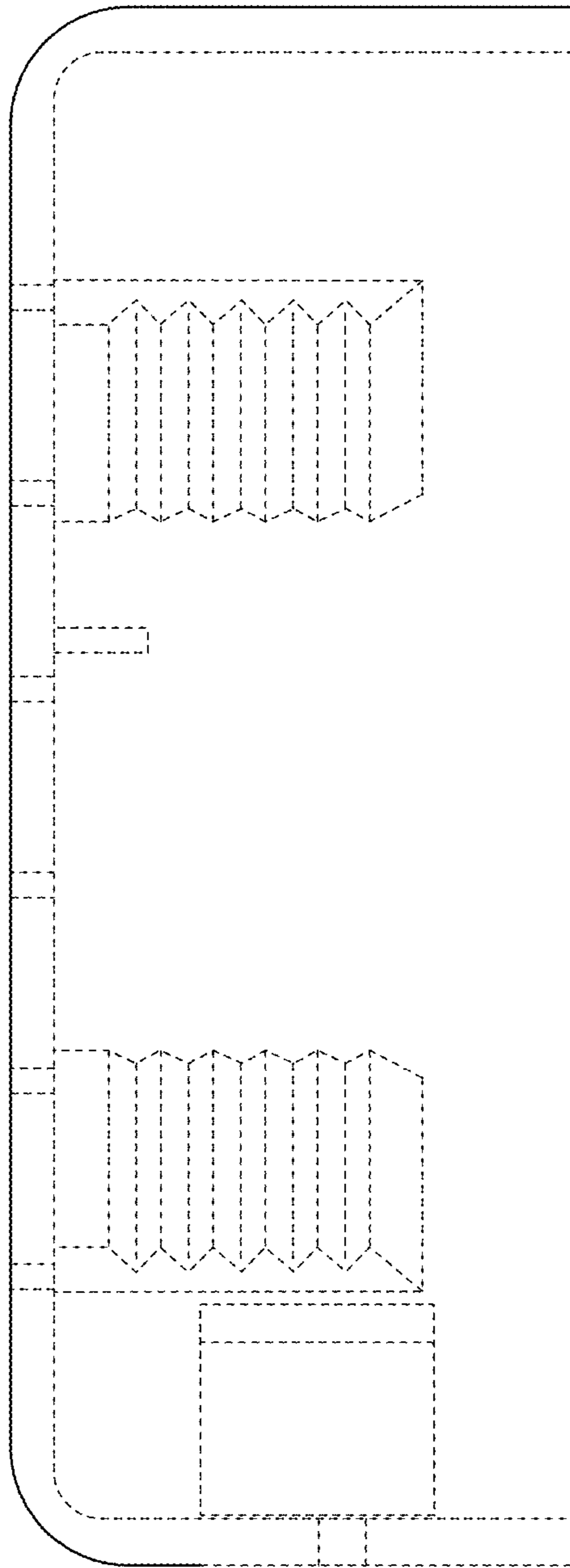

FIG. 7





**FIG. 8**

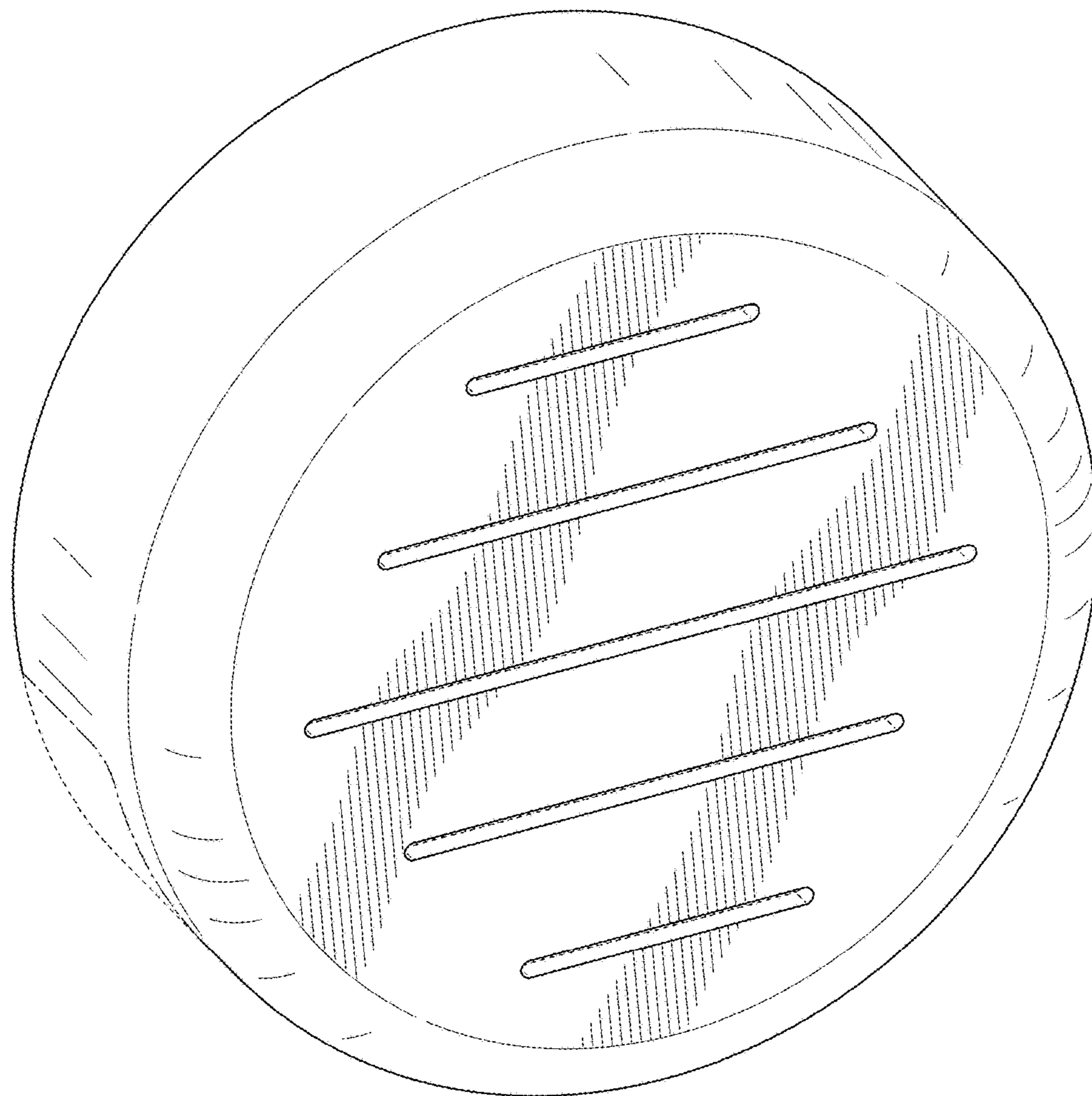

FIG. 9

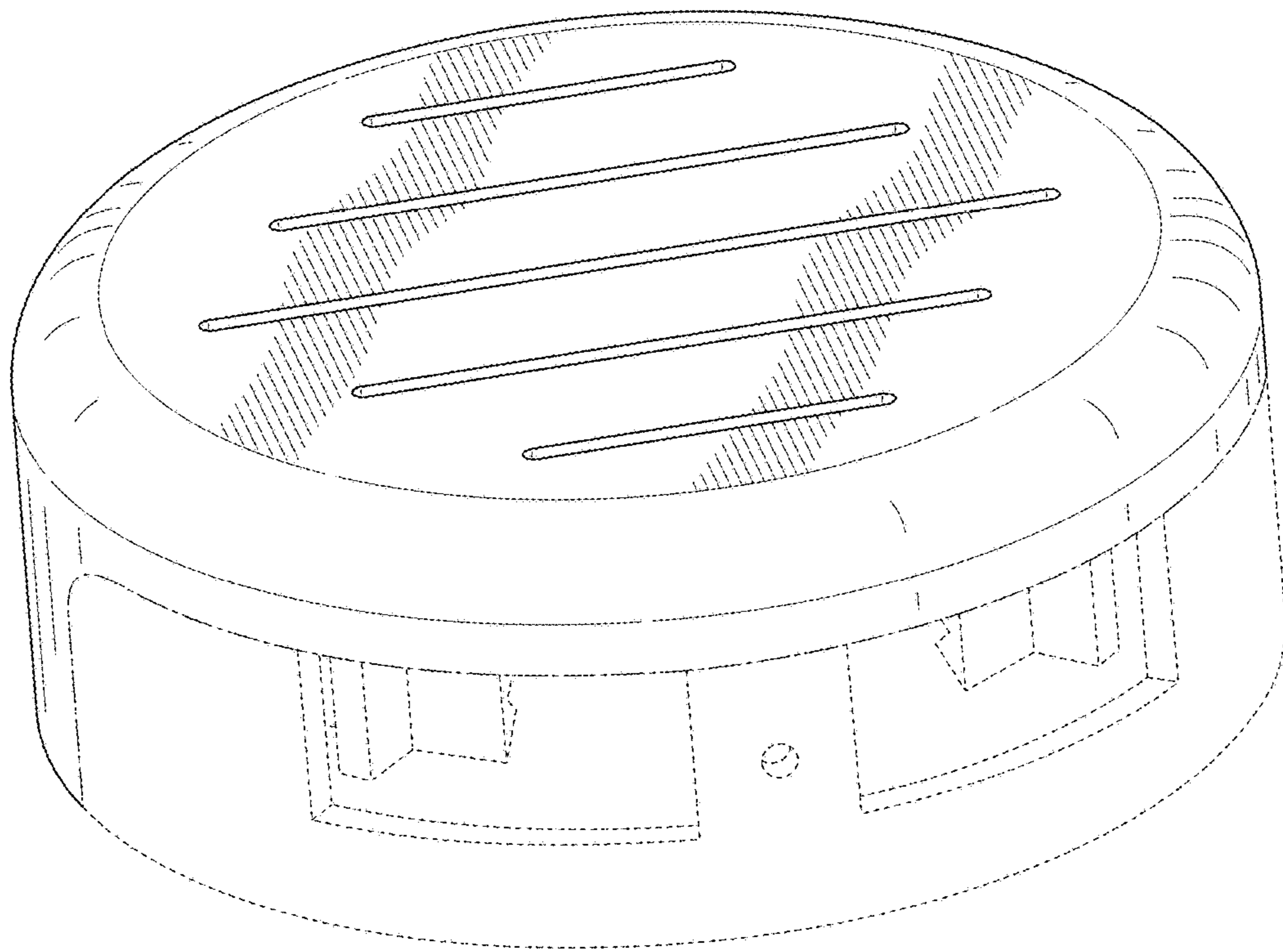

FIG. 10

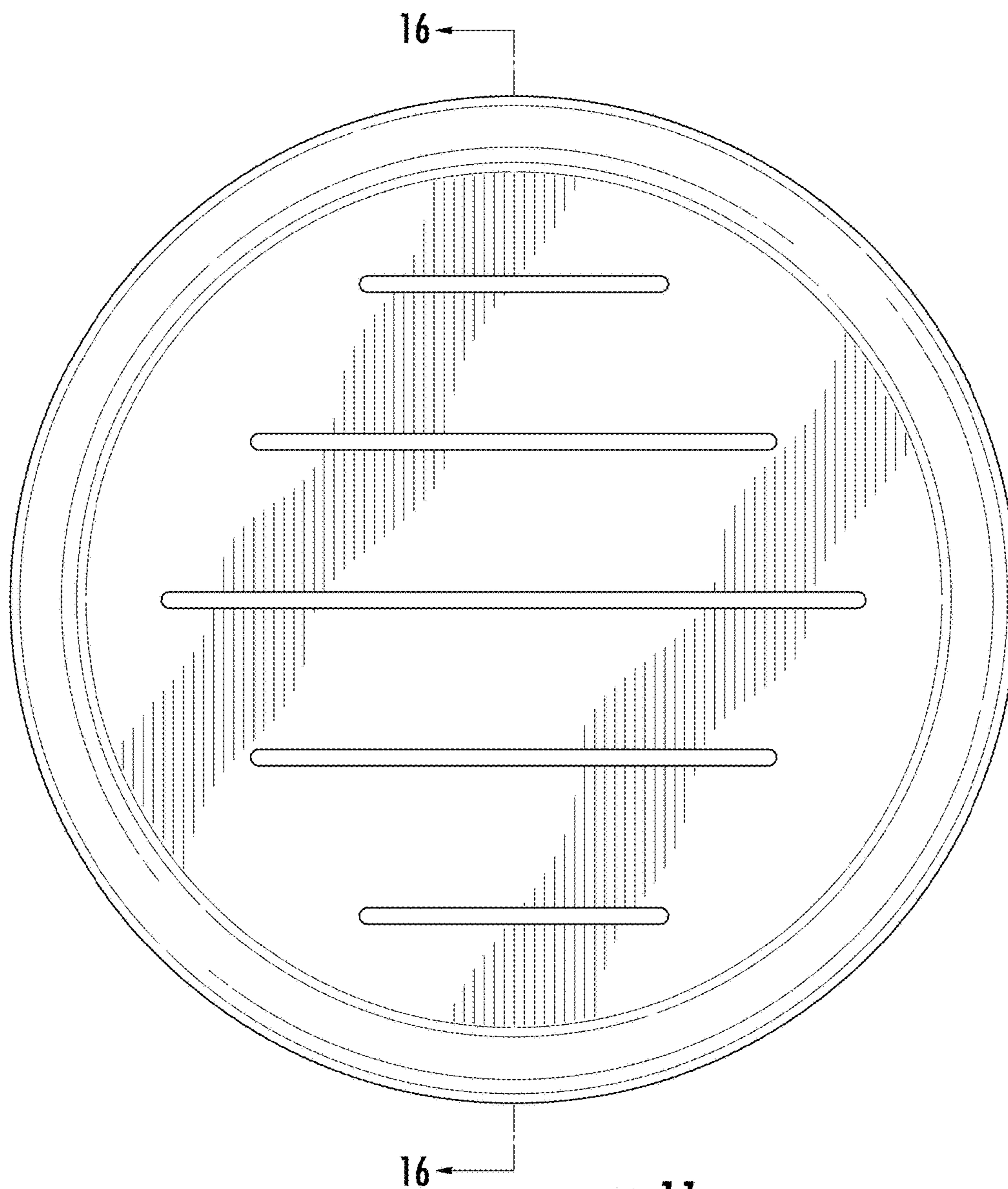

FIG. 11

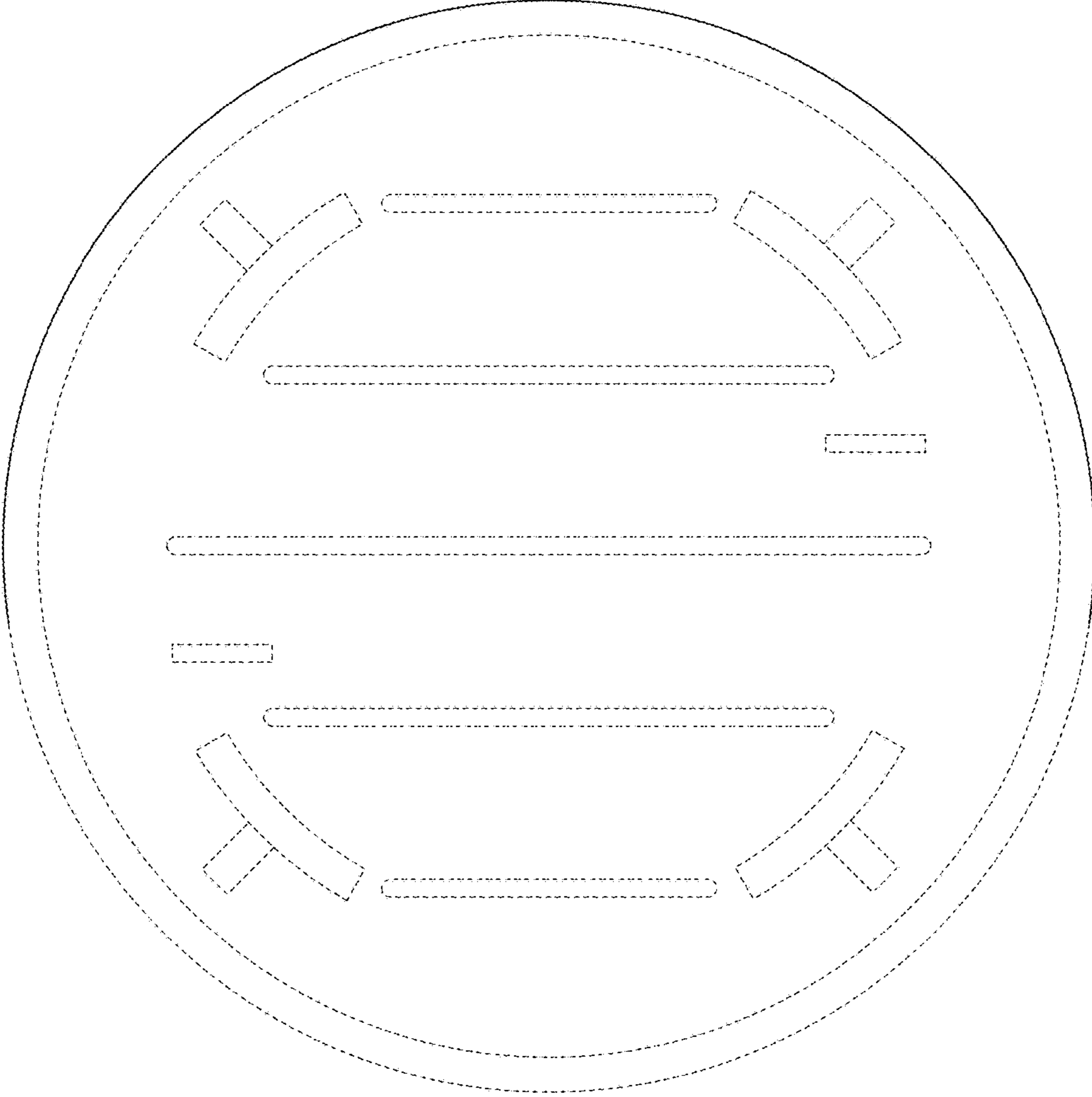
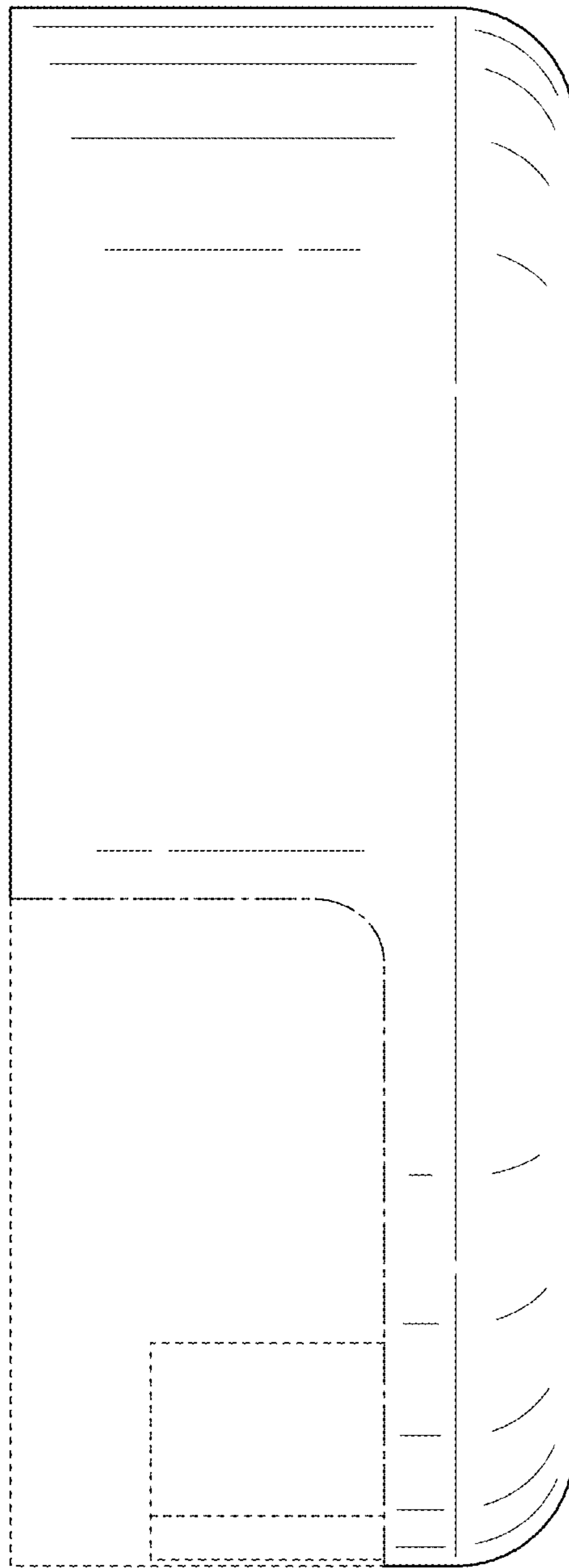

FIG. 12



**FIG. 13**



FIG. 14

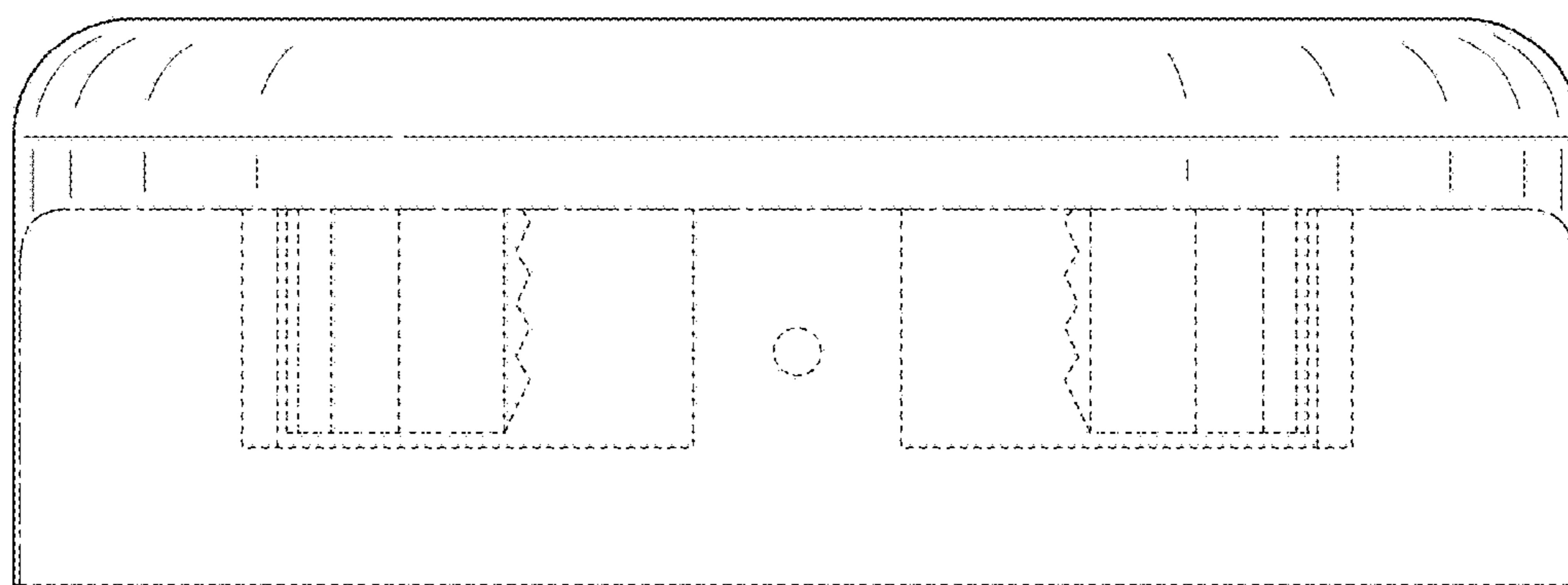
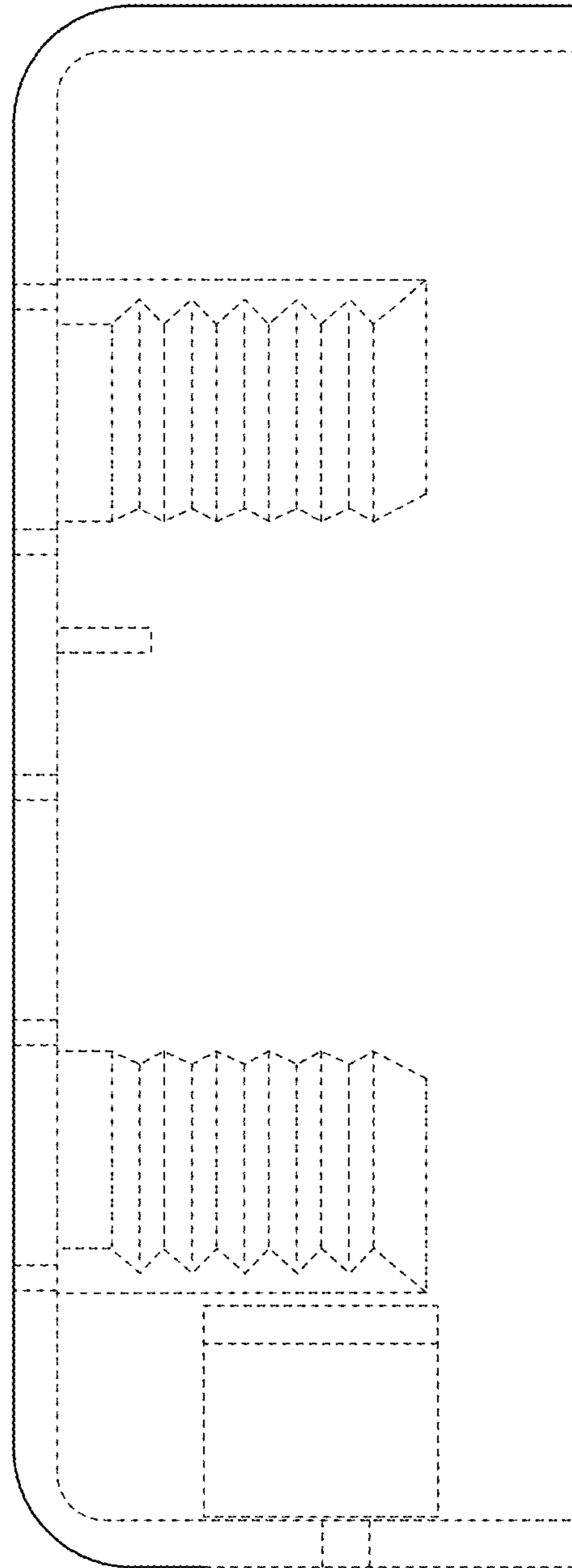

FIG. 15



**FIG. 16**



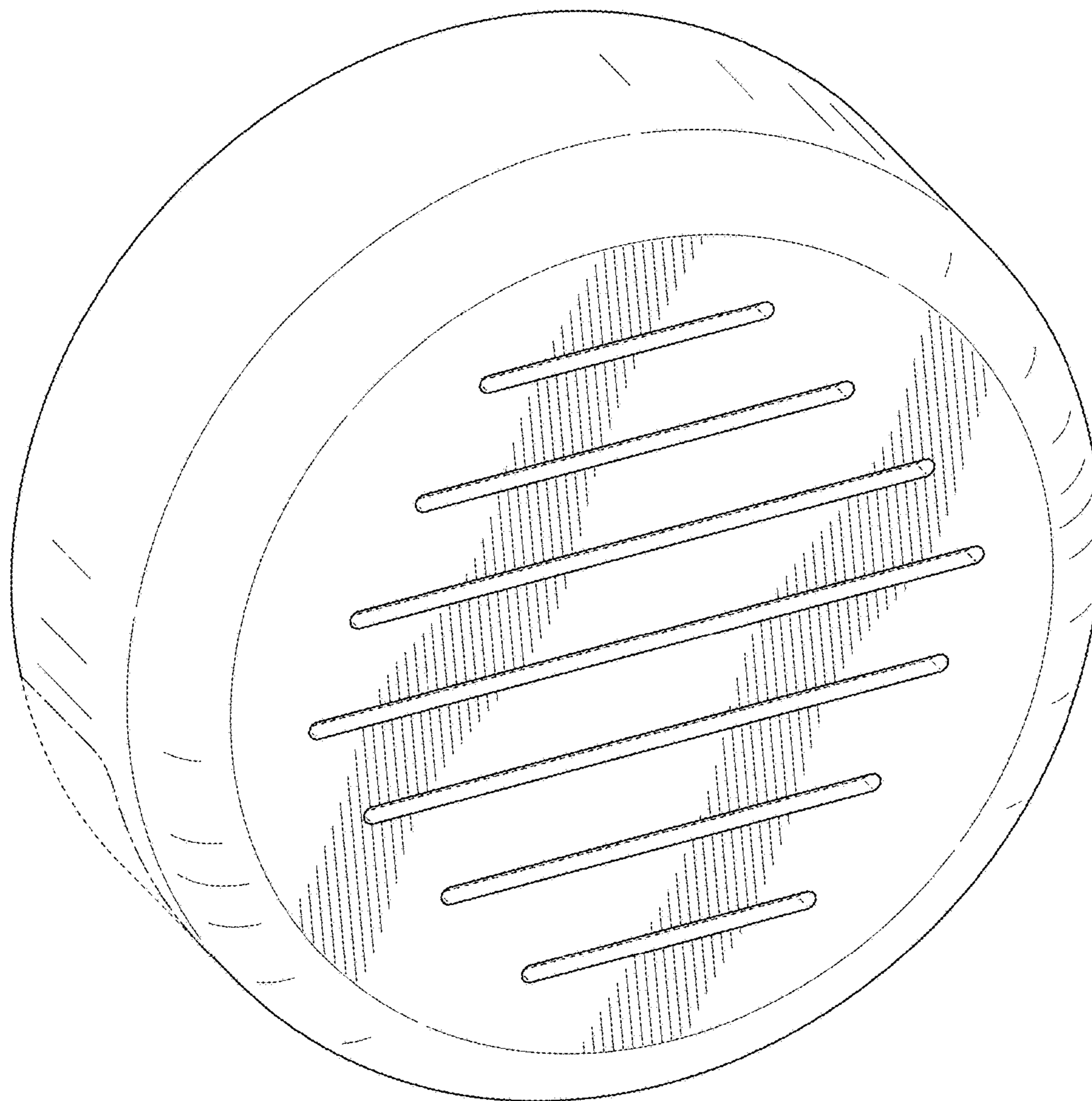

FIG. 17

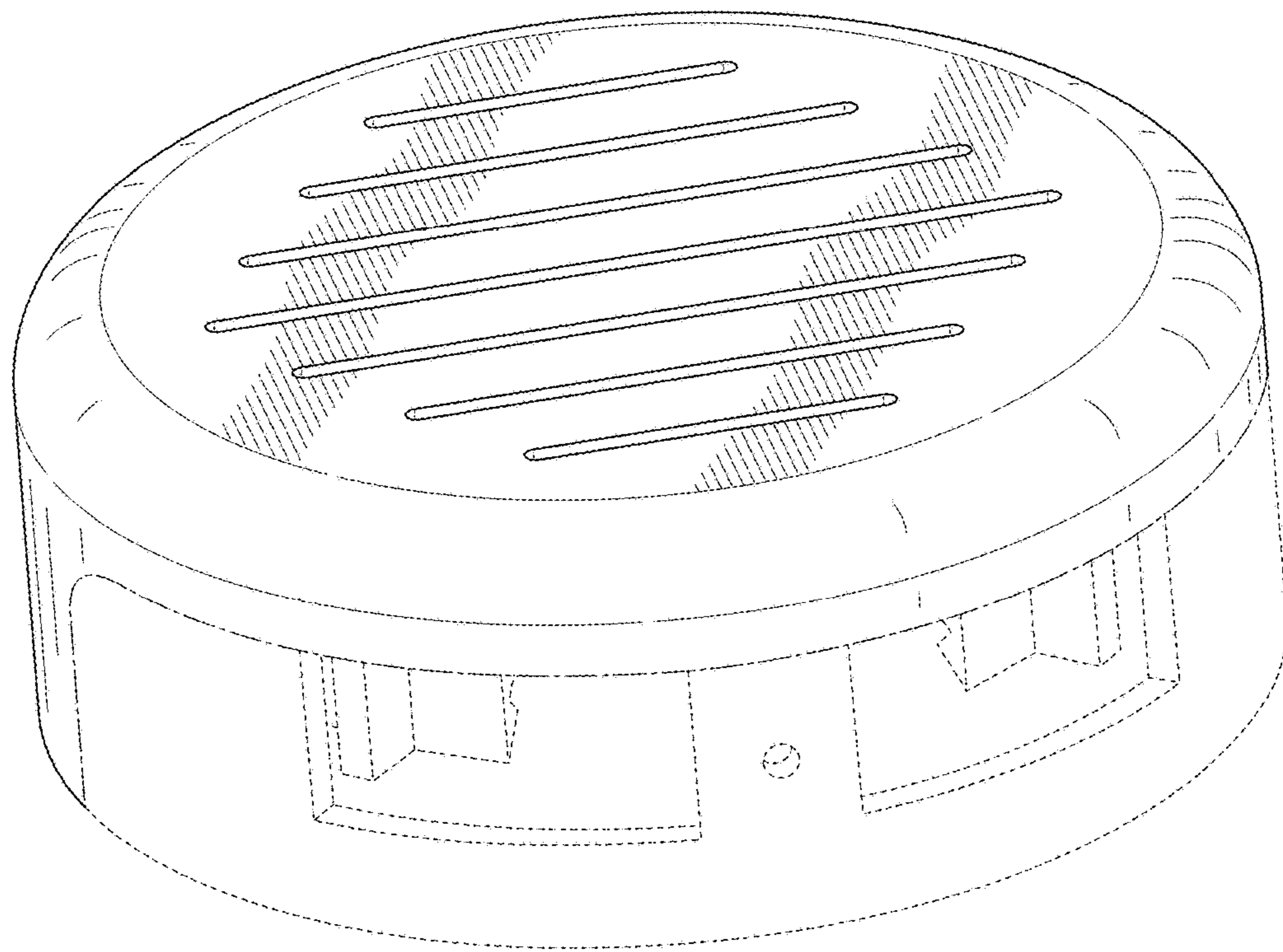

FIG. 18

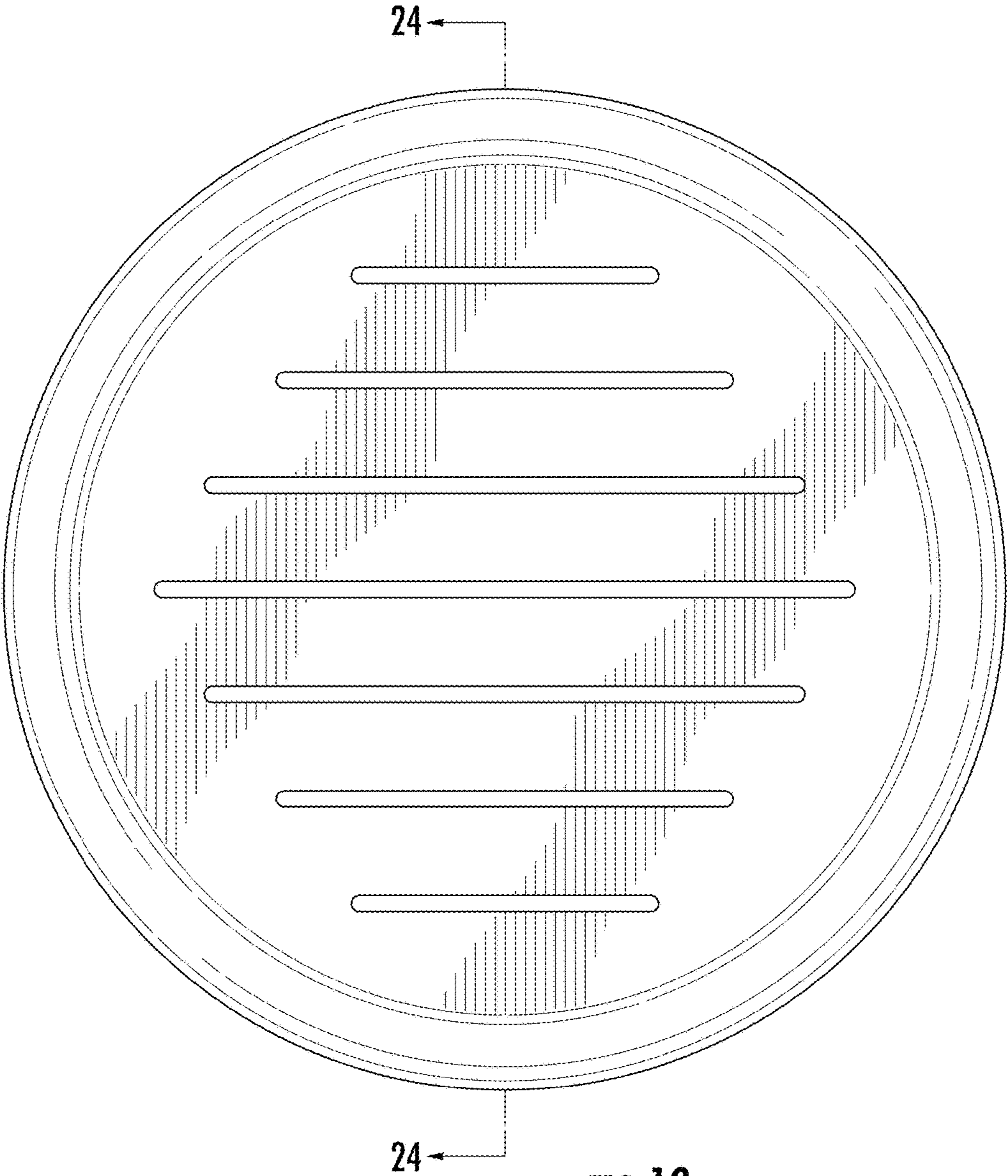

FIG. 19

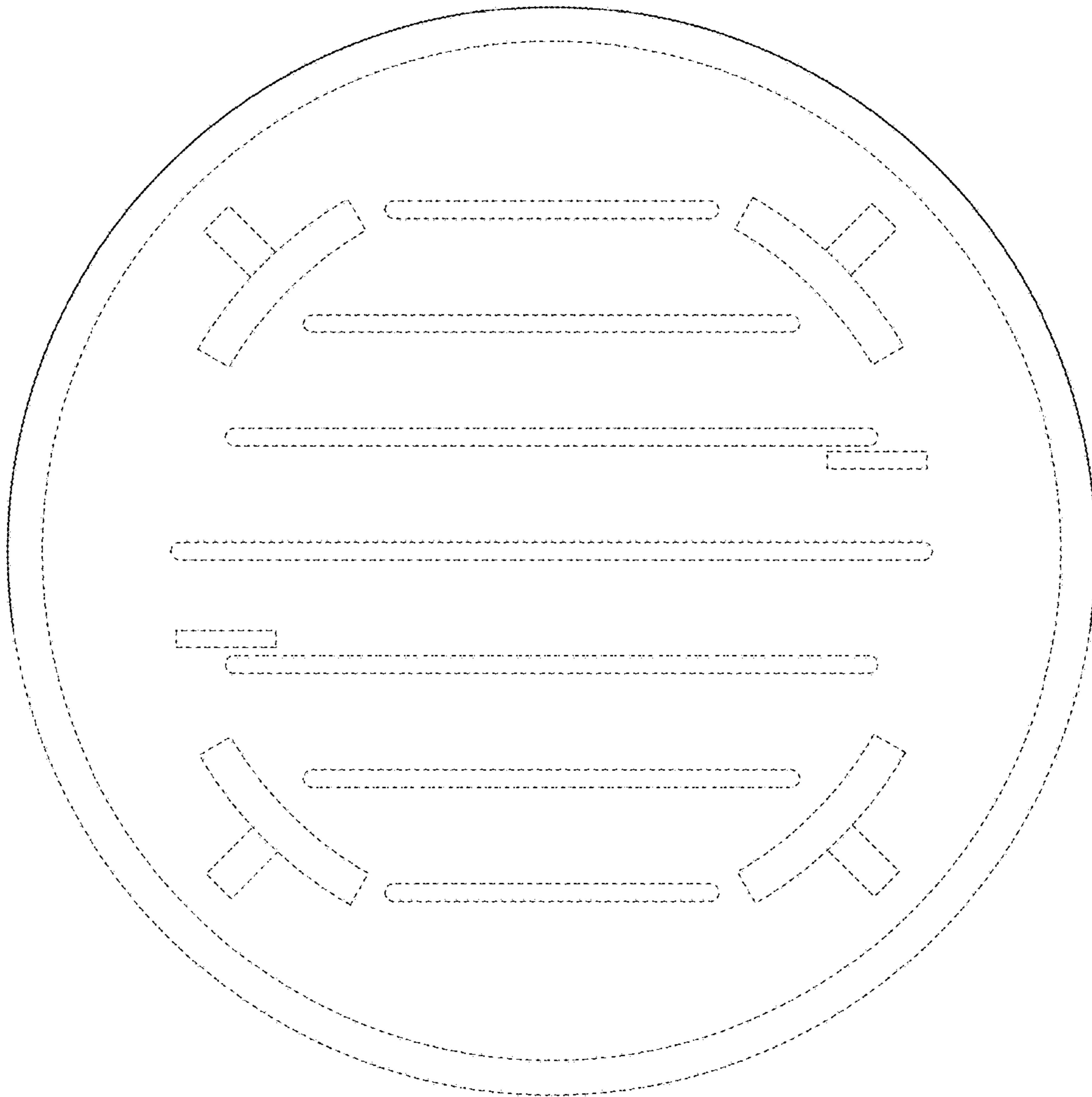
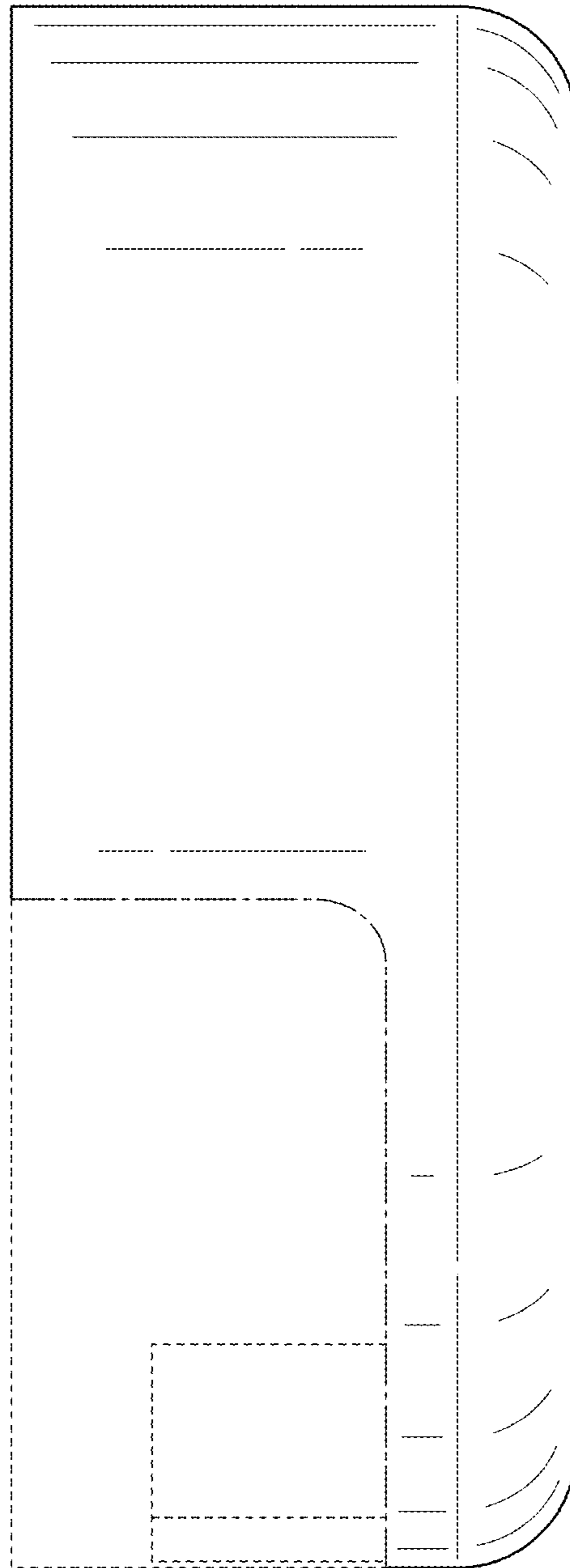

FIG. 20



**FIG. 21**

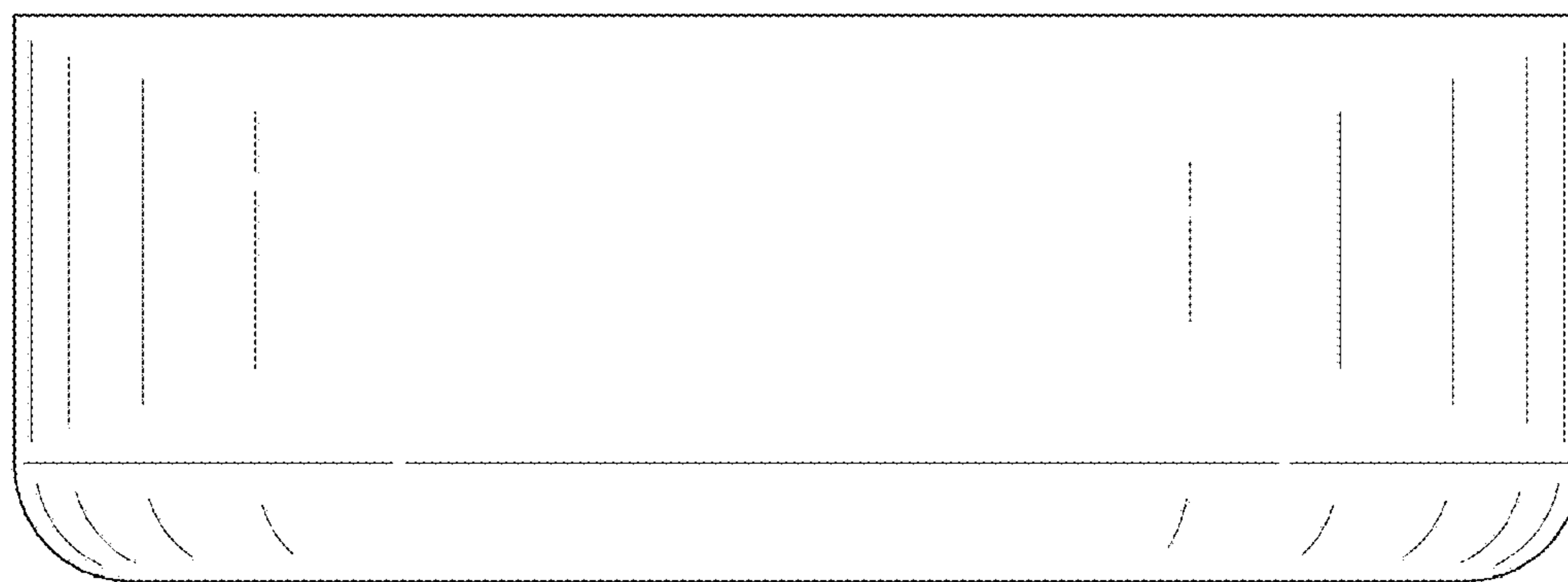

FIG. 22

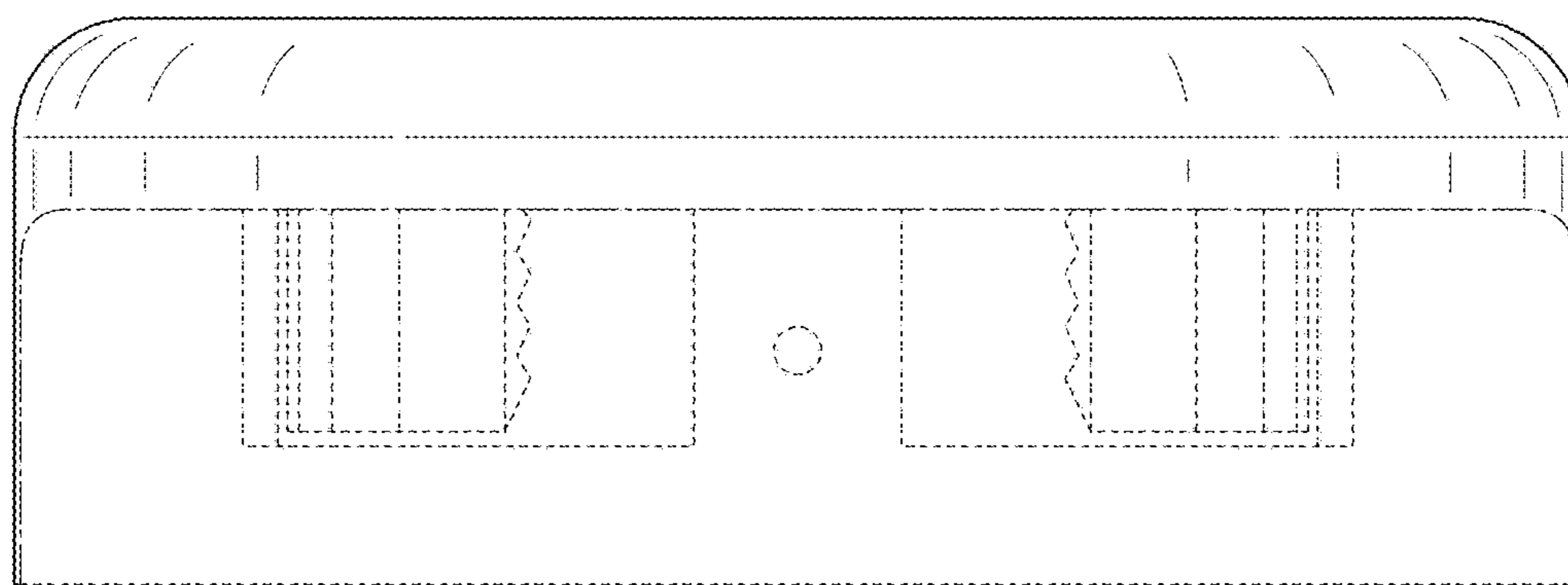
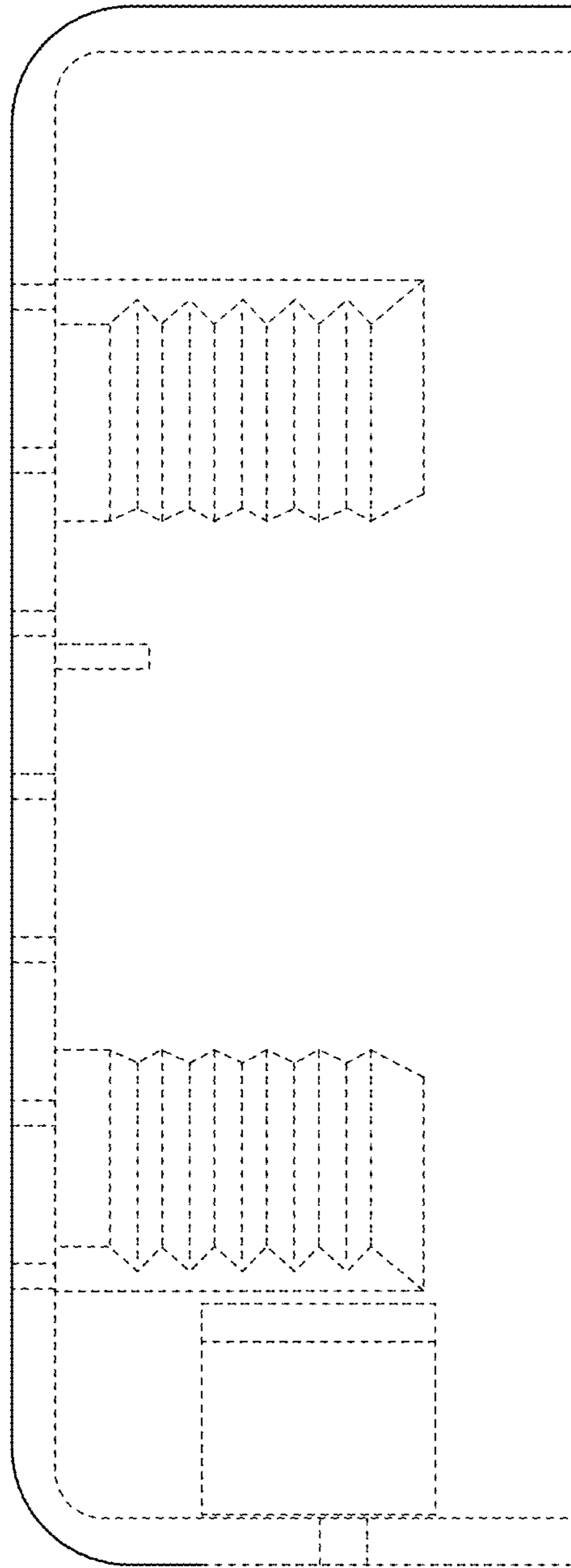

FIG. 23



**FIG. 24**