



US00D839361S

(12) **United States Design Patent** (10) **Patent No.:** **US D839,361 S**  
**Lederer** (45) **Date of Patent:** **\*\* Jan. 29, 2019**

(54) **FIDGET TOY**

(71) Applicant: **Prime Resources Corp.**, Bridgeport, CT (US)

(72) Inventor: **Jeffrey Lederer**, Greenwich, CT (US)

(73) Assignee: **BRODER BROS, CO.**, Trevese, PA (US)

(\*\*) Term: **15 Years**

(21) Appl. No.: **29/614,688**

(22) Filed: **Aug. 22, 2017**

(51) **LOC (11) Cl.** ..... **21-01**

(52) **U.S. Cl.**

USPC ..... **D21/455**; D21/475; D21/398

(58) **Field of Classification Search**

USPC ..... D21/331-333, 468, 475, 476, 477, 512, D21/513, 516, 517, 455, 460, 461-464, D21/566; D3/208-211; D11/2; D19/123, 127, 128, 130, 136, 156, 189, D19/202, 95, 100, 59, 60; D10/2, 30, 31, D10/37, 38, 40, 41, 46, 46.1, 53, 62, 72, D10/97, 104.2, 106.1, 106.9, 114.9, D10/116.1; D26/37, 38, 46, 51, 53, 54; D28/77, 79; 446/143, 144, 227, 233-236, 446/397, 487, 489, 491; D14/357, 358, D14/388, 400, 401, 412, 415-417, 426, D14/454, 455, 480.3, 480.6, 484, D14/507-510, 138 R, 138 AA, 138 AB, D14/138 AC, 138 AD, 168, 203.1, 203.2, D14/203.4, 226, 252, 218

CPC ..... A63H 1/00-1/32; A63H 33/00; A63H 33/006; A63H 33/26; A63H 33/30; A63H 33/3016; A63H 33/3027; A63H 33/3033; A63H 33/3066; A63H 33/3072; A63H 33/42; A63H 5/00; A63F 9/001; A63F 2009/0018; A63F 2009/002; A63F 2009/0021; A63F 2009/0023; A63F 2009/0024; A63F 2009/0026; A63F

(Continued)

(56) **References Cited**

U.S. PATENT DOCUMENTS

2,507,570 A \* 5/1950 Jensen ..... A63F 5/04  
273/141 R

D187,478 S \* 3/1960 Parrilla ..... D21/455  
(Continued)

FOREIGN PATENT DOCUMENTS

CN 201333303 Y 10/2009  
CN 304228933 \* 8/2017

(Continued)

OTHER PUBLICATIONS

Karlesky et al., "Fidget Widgets: Secondary Playful Interactions in Support of Primary Serious Tasks", CHI '13 Extended Abstracts on Human Factors in Computing Systems, Apr. 27-May 2, 2013, pp. 1149-1154, Paris, France.

(Continued)

*Primary Examiner* — Catherine A Tuttle

(74) *Attorney, Agent, or Firm* — Myers Wolin, LLC

(57) **CLAIM**

The ornamental design for a fidget toy, as shown and described.

**DESCRIPTION**

FIG. 1 is a front perspective view of a fidget toy showing my new design;

FIG. 2 is a rear perspective view thereof;

FIG. 3 is a front elevational view thereof;

FIG. 4 is a left side elevational view thereof, the right side elevational view being a mirror image thereof;

FIG. 5 is a rear elevational view thereof;

FIG. 6 is a top plan view thereof; and,

FIG. 7 is a bottom plan view thereof.

**1 Claim, 2 Drawing Sheets**

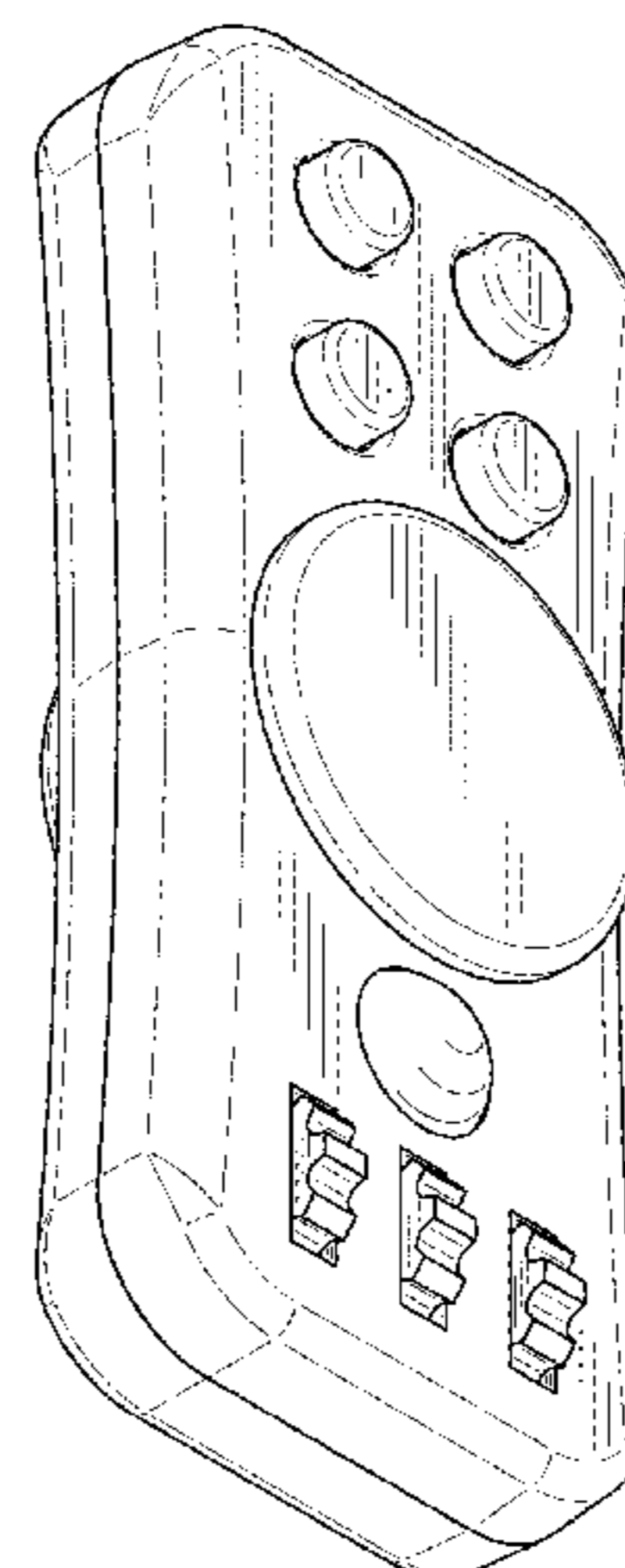
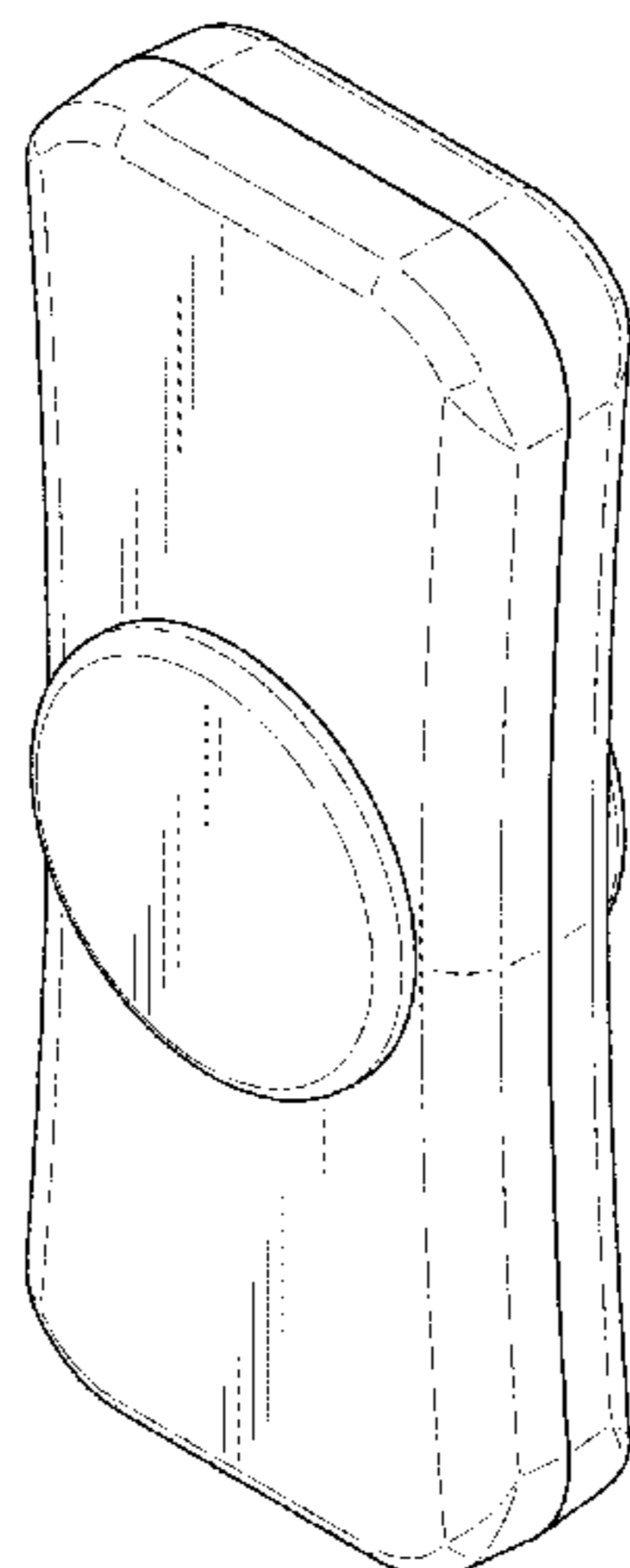

(58) **Field of Classification Search**

CPC ..... 2009/0027; A63F 2009/0029; A63F  
 2009/003; A63F 2009/0047; A63F  
 2009/0049; A63F 2009/0052; A63F  
 2009/0061; A63F 2009/063; A63F  
 2009/0069; A63F 2009/0072; A63F  
 2009/2402-2009/2441; A63F 2003/00268;  
 A63F 2003/00274; A63F 2003/00287;  
 A63F 11/0011; A63F 11/0051; A63F  
 2011/0016; A63F 2011/0072

See application file for complete search history.

(56) **References Cited**

U.S. PATENT DOCUMENTS

3,220,142 A \* 11/1965 Butterfield ..... A63H 33/18  
 446/46  
 3,337,984 A \* 8/1967 Tomasello ..... A63H 1/00  
 446/138  
 3,696,533 A 10/1972 Mortensen  
 D278,070 S \* 3/1985 Tapdrup ..... D21/475  
 5,067,923 A \* 11/1991 de Bourbon ..... A63H 33/18  
 434/258  
 5,069,646 A 12/1991 Hanson et al.  
 D335,900 S \* 5/1993 Oshimi ..... D21/475  
 5,299,527 A \* 4/1994 Grossman ..... A63H 33/30  
 116/323  
 D373,149 S \* 8/1996 Kawasaki ..... D14/401  
 5,591,062 A 1/1997 Hettinger  
 D410,045 S \* 5/1999 Fletcher ..... D21/513  
 7,044,827 B1 5/2006 Krull

D568,827 S \* 5/2008 Ikeda ..... D13/168  
 D570,349 S \* 6/2008 Ashida ..... D14/400  
 D801,440 S \* 10/2017 Pavelsky ..... D21/455  
 9,914,063 B1 \* 3/2018 McCoskery ..... A63H 29/08  
 9,950,556 B1 \* 4/2018 Laemle ..... B43K 29/00  
 D818,054 S \* 5/2018 McLachlan ..... D21/468  
 10,016,693 B1 \* 7/2018 Dowdy ..... A63H 33/003  
 2013/0225036 A1 \* 8/2013 Kaye ..... A63H 1/00  
 446/233  
 2015/0202544 A1 7/2015 Snee, Jr. et al.

FOREIGN PATENT DOCUMENTS

CN 304254150 \* 8/2017  
 DE 2907306 A1 \* 8/1980 ..... A63H 30/04  
 DE 202017103662 U1 \* 9/2017 ..... A63H 1/00  
 EM 004016657-0009 \* 5/2017  
 EM 004023943-0005 \* 6/2017  
 EM 004028587-0002 \* 7/2017  
 EM 004033793-0010 \* 8/2017  
 EM 004033793-0013 \* 8/2017  
 FR 1063989 A \* 5/1954 ..... A63H 1/32  
 KR 300637939.0000 \* 2/2012  
 WO WO-2004103507 A1 \* 12/2004 ..... A63H 5/00

OTHER PUBLICATIONS

Snee Jr., "Squidget A toy that can change the world and be fun too!",  
 pp. 1-6, URL: <<https://www.kickstarter.com/projects/1814677888/squidget-transform-your-fidgeting-into-productivity/description>>, Jul.  
 24, 2014.

\* cited by examiner

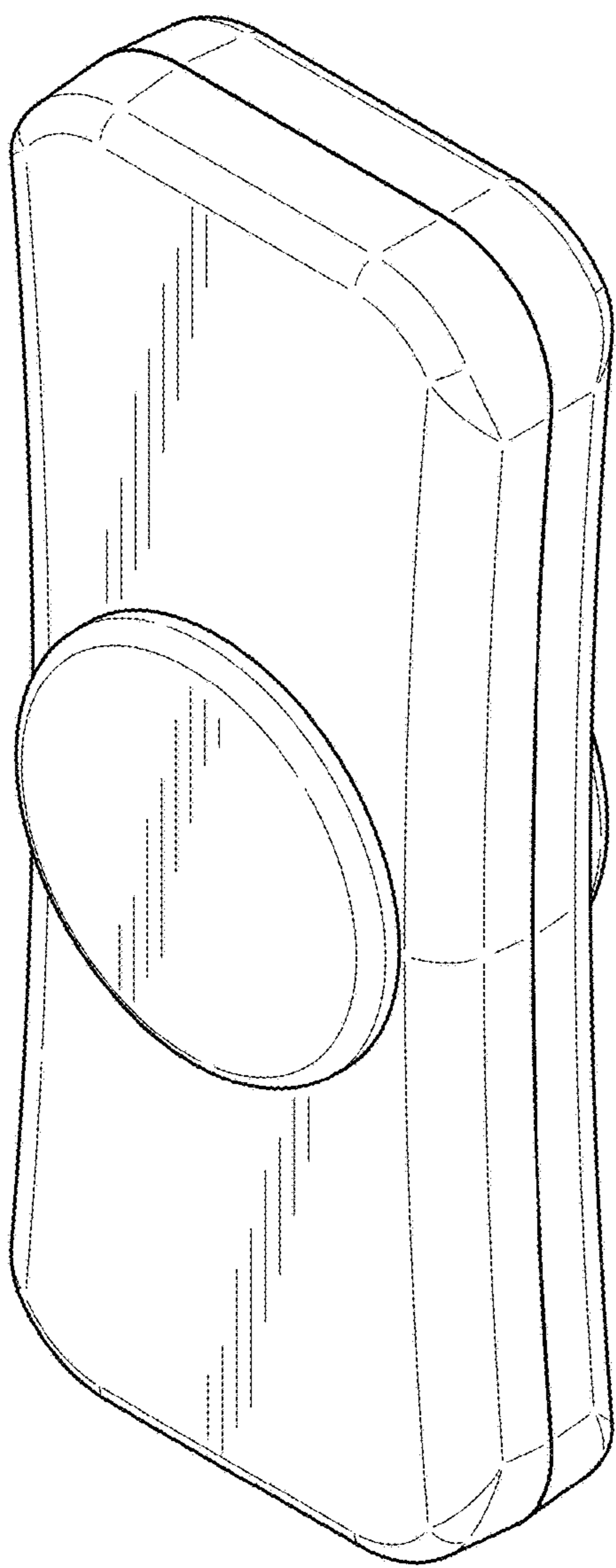

*FIG. 1*

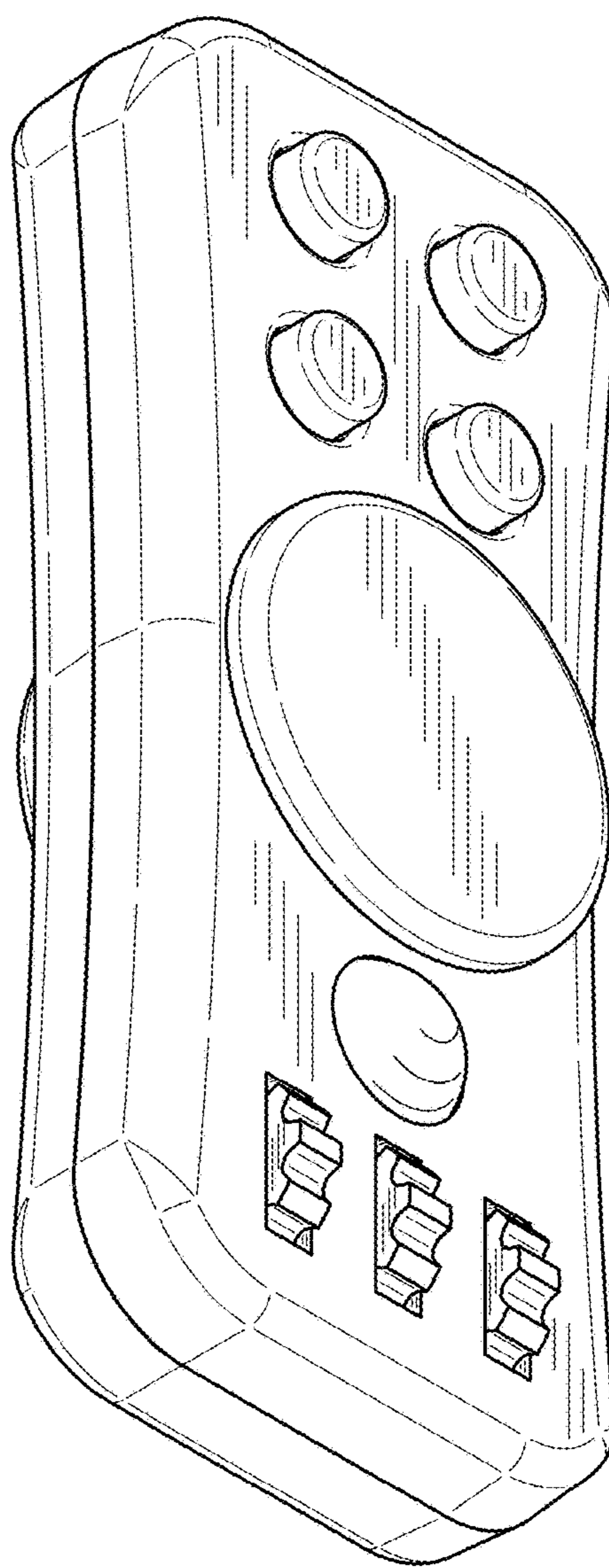

*FIG. 2*

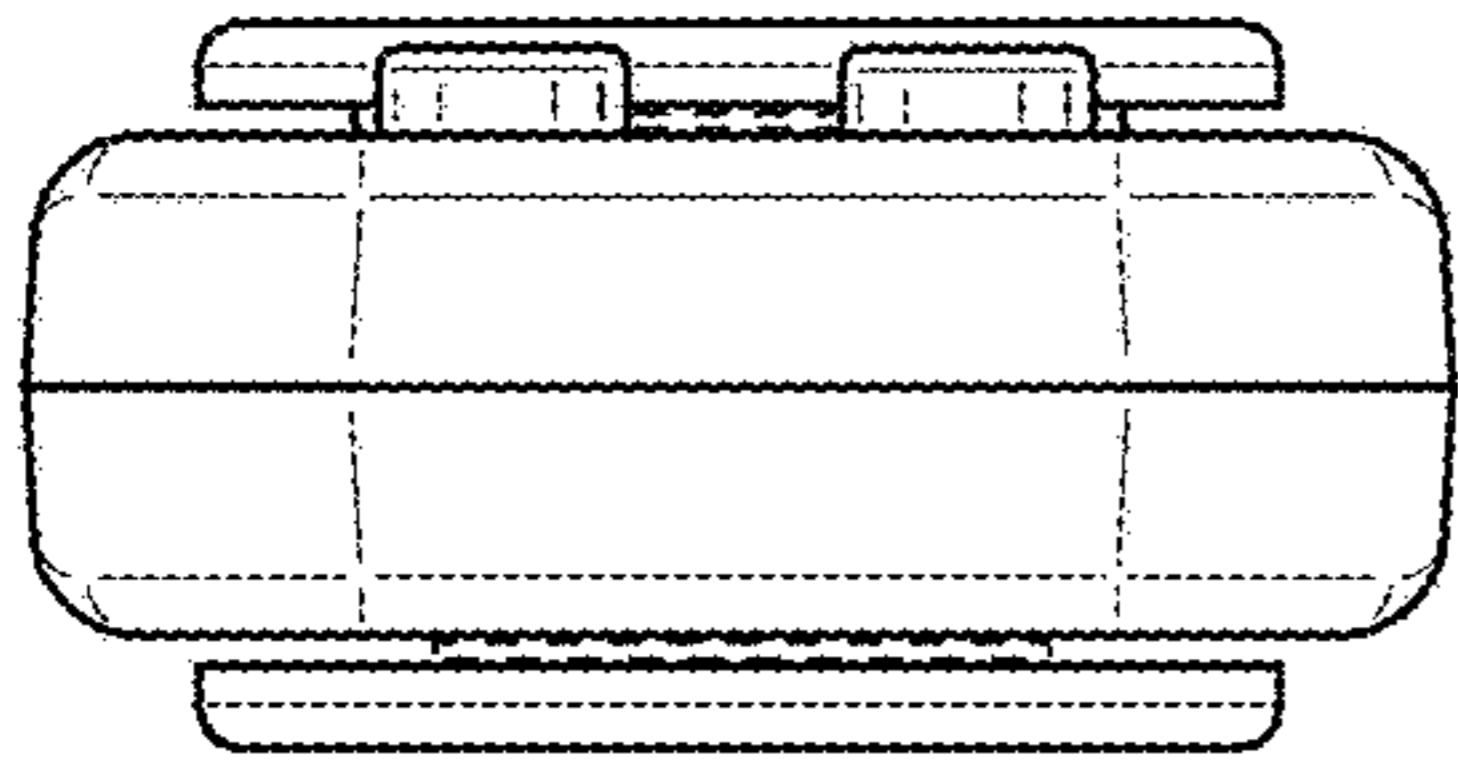

FIG. 6

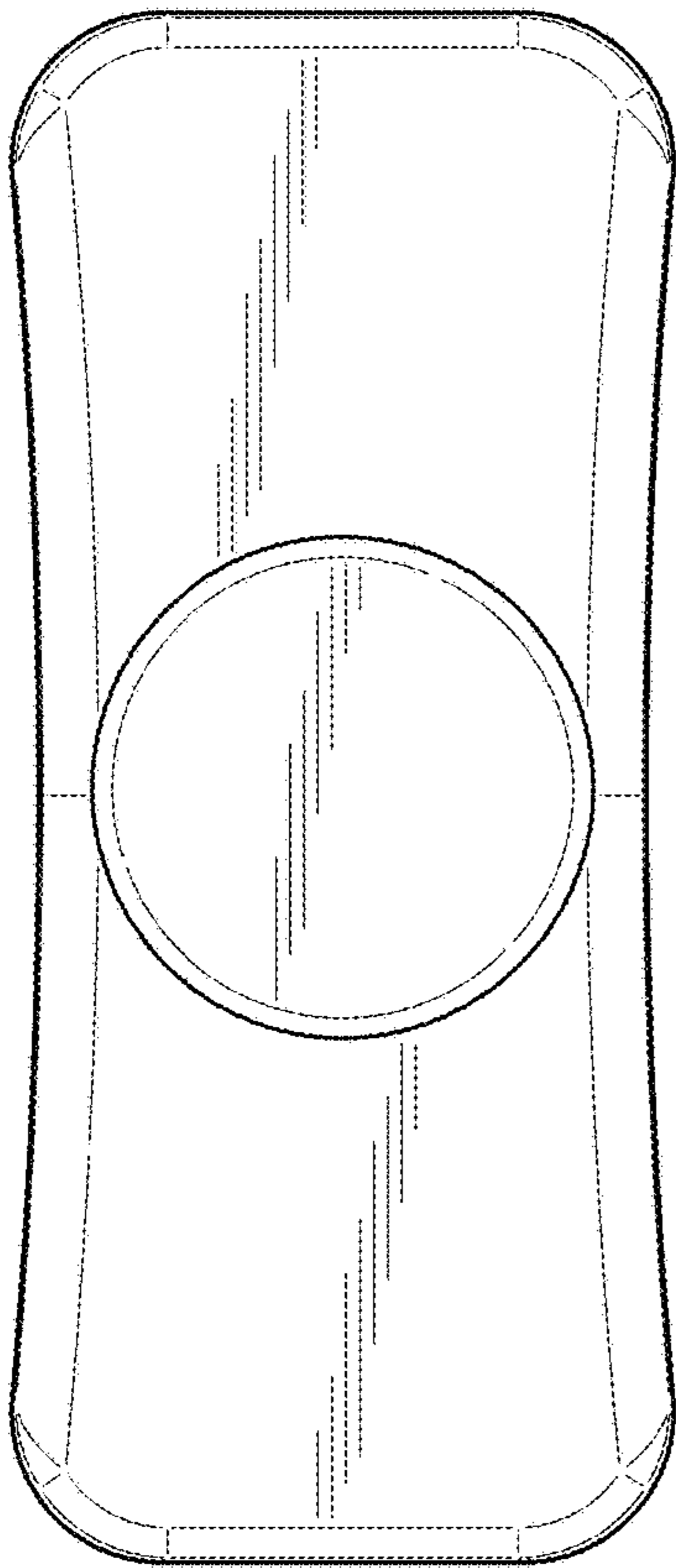

FIG. 3

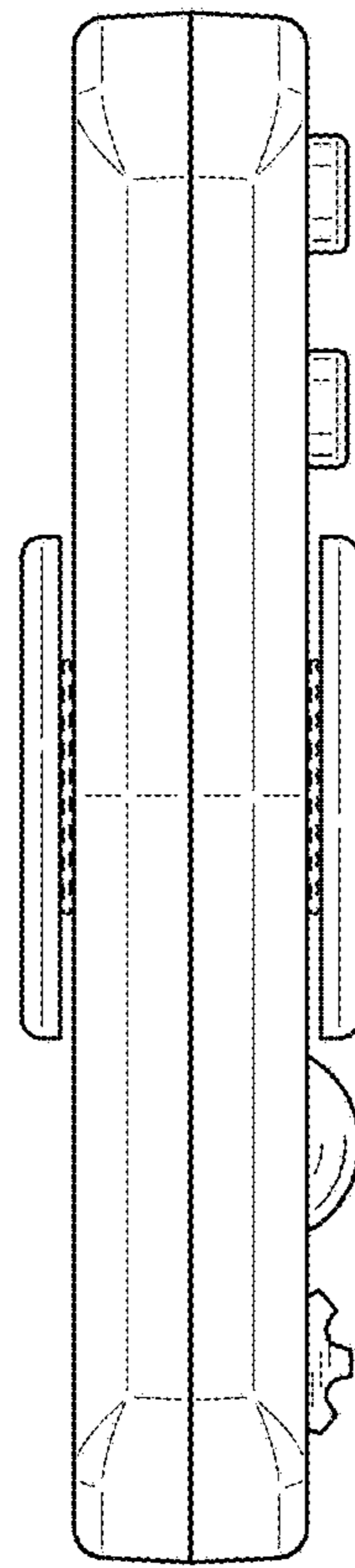

FIG. 4

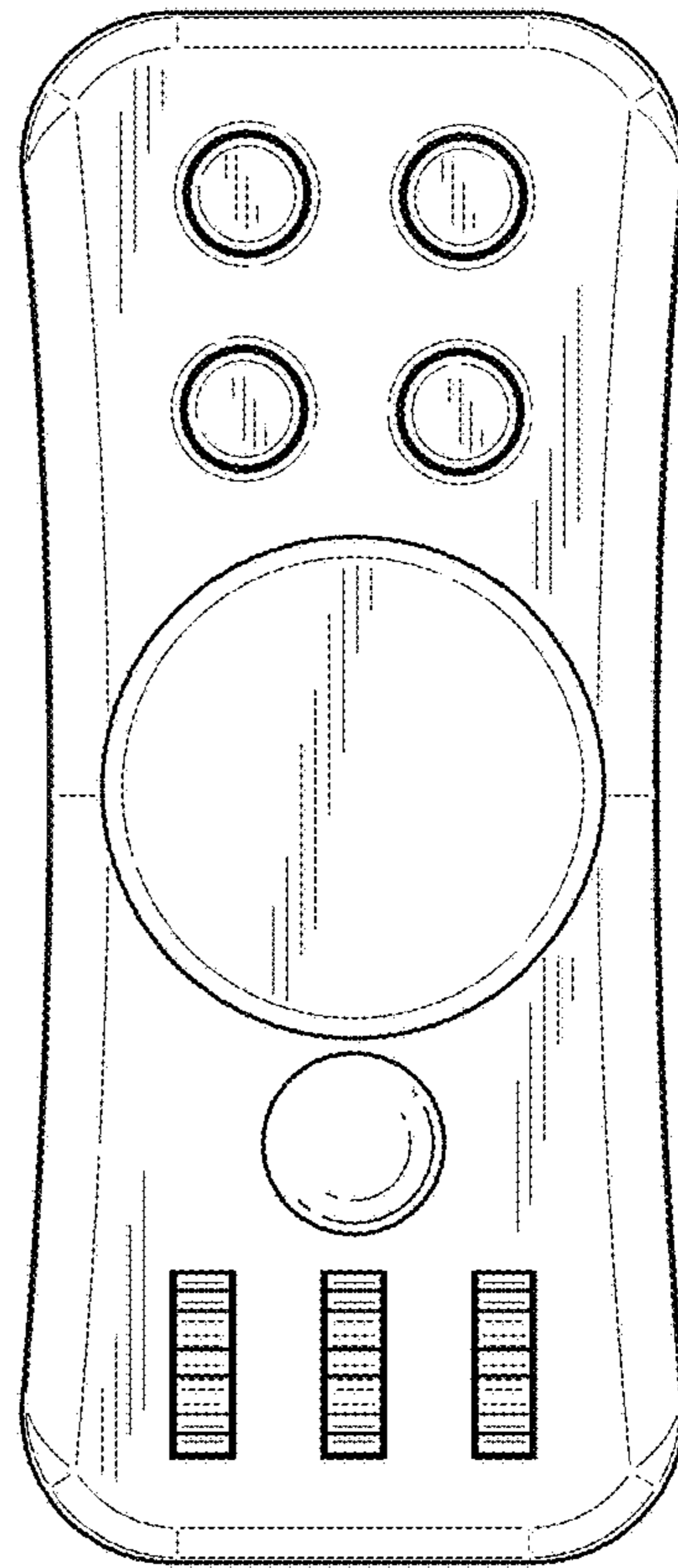

FIG. 5

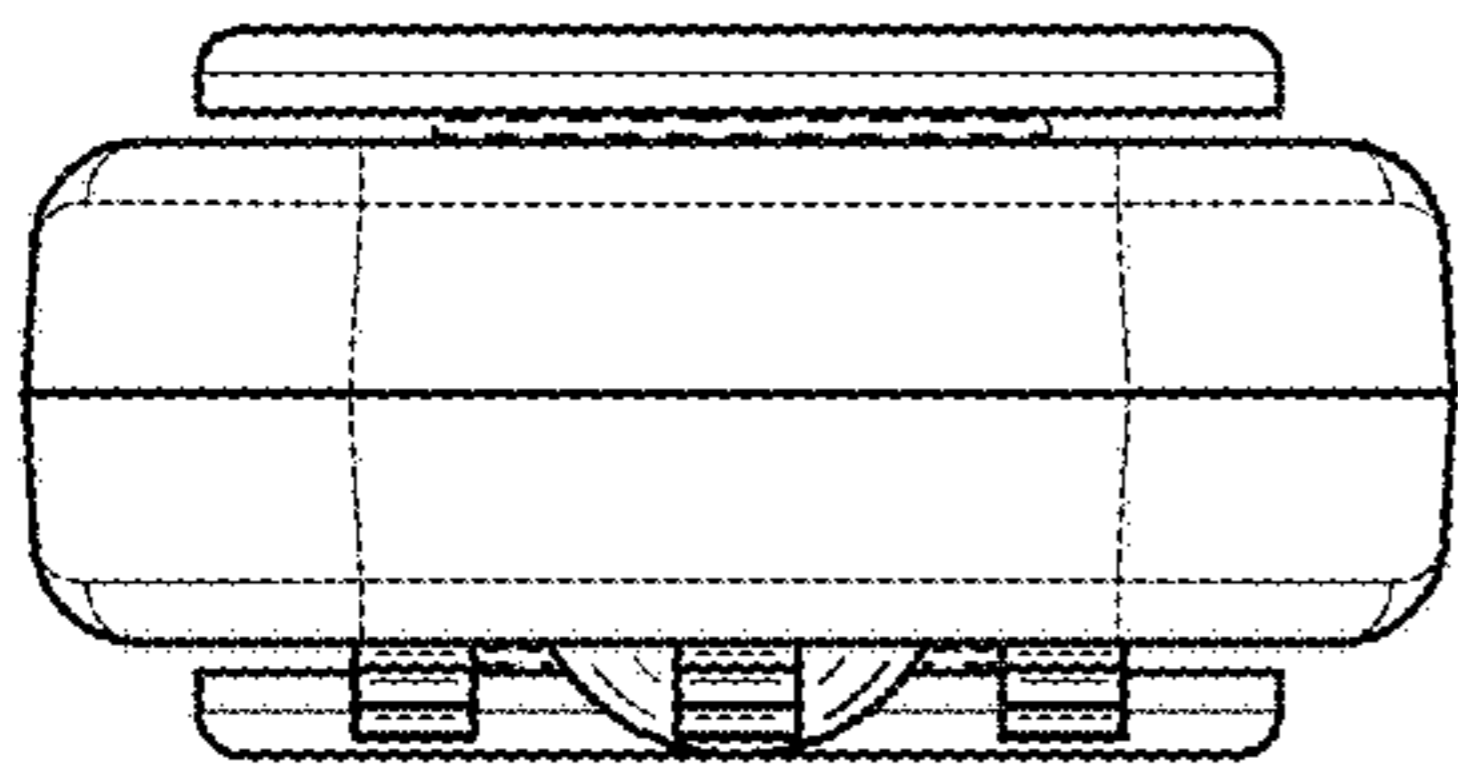

FIG. 7