



US00D839354S

(12) **United States Design Patent**
Christie et al.

(10) **Patent No.:** **US D839,354 S**
(45) **Date of Patent:** **** Jan. 29, 2019**

(54) **ELECTRONIC HOUSING WITH
REMOVABLE SUPPORT STAND**

(71) Applicant: **Microsoft Corporation**, Redmond, WA
(US)

(72) Inventors: **Brett D. Christie**, Seattle, WA (US);
Bryan A. Sparks, Sammamish, WA
(US); **Carl J. Ledbetter**, Mercer Island,
WA (US); **Gregory Jones**, Seattle, WA
(US); **Nicolas Denhez**, Seattle, WA
(US); **Scott Dallmeyer**, Seattle, WA
(US)

(73) Assignee: **Microsoft Corporation**, Redmond, WA
(US)

(**) Term: **15 Years**

(21) Appl. No.: **29/607,129**

(22) Filed: **Jun. 9, 2017**

(51) **LOC (11) Cl.** **21-01**

(52) **U.S. Cl.**
USPC **D21/332**; D14/496

(58) **Field of Classification Search**
USPC D14/496, 401, 435, 474, 483, 217, 137,
D14/138, 160, 168, 356, 203.1–203.8,
(Continued)

(56) **References Cited**

U.S. PATENT DOCUMENTS

5,196,993 A * 3/1993 Herron F16M 11/10
248/923

D336,287 S 6/1993 Mizusugi et al.
(Continued)

FOREIGN PATENT DOCUMENTS

JP 2002246639 A 8/2002
JP 2002323633 A 11/2002
JP 2003008054 A 1/2003

OTHER PUBLICATIONS

Apr. 5, 2017—U.S. Final Office Action—U.S. Appl. No. 29/564,511,
filed May 13, 2016; Inv.: Bryan A. Sparks.

(Continued)

Primary Examiner — Keli L Hill

(74) *Attorney, Agent, or Firm* — Banner & Witcoff, Ltd.

(57) **CLAIM**

The ornamental design for an electronic housing with
removable support stand, as shown and described.

DESCRIPTION

FIG. 1 is a front perspective view of an electronic housing
with removable support stand showing our new design in a
first state, and identifies a region for enlargement in FIG. 8;
FIG. 2 is a front view thereof;
FIG. 3 is a rear view thereof;
FIG. 4 is a right side view thereof;
FIG. 5 is a left side view thereof;
FIG. 6 is a top view thereof;
FIG. 7 is a bottom view thereof;
FIG. 8 is an enlarged view of the encircled portion in FIG.
1;
FIG. 9 is a front perspective view of an electronic housing
with removable support stand showing our new design in a
second state;
FIG. 10 is a front view thereof;
FIG. 11 is a rear view thereof;
FIG. 12 is a right side view thereof;
FIG. 13 is a left side view thereof;
FIG. 14 is a top view thereof; and,
FIG. 15 is a bottom view thereof.
The broken line showing of the various unshaded elements
of the electronic housing in FIGS. 1-15 illustrates environ-
mental structure and forms no part of the claimed design.

1 Claim, 15 Drawing Sheets

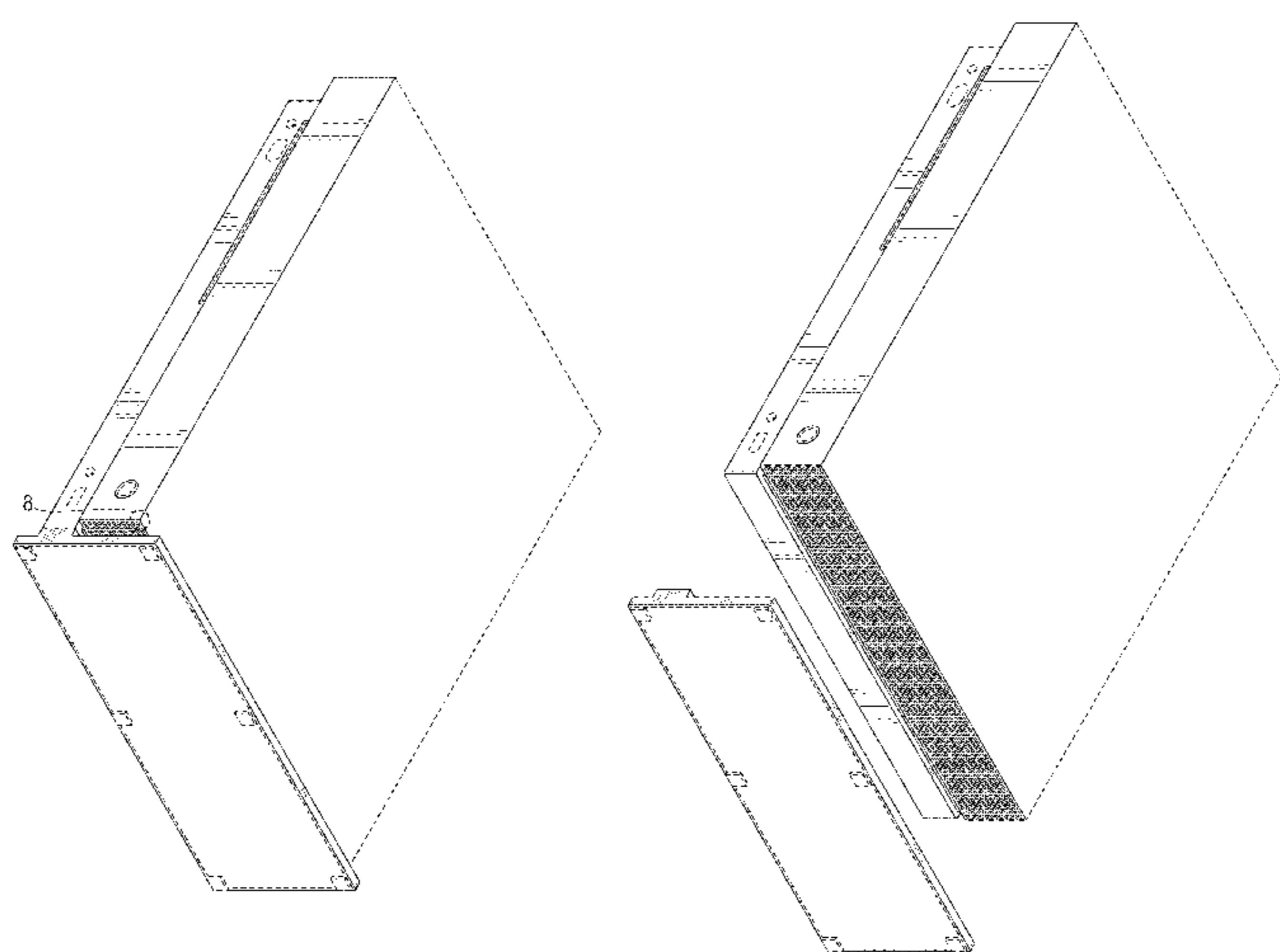

(58) **Field of Classification Search**

USPC D14/507; 345/156, 169, 173–179, 905;
 715/727–729, 864; 710/1, 5, 8; 713/1,
 713/600; 455/1.1, 1.7, 73, 344–347, 93,
 455/95, 3.01–3.06, 550.1, 573.1;
 370/342–344; 369/1, 2, 6–12;
 463/43–47, 29–35; 273/148 B;
 D21/324–333
 CPC A63F 9/00; A63F 9/24; A63F 11/00; A63F
 13/00; H04J 1/08; H04J 15/00; H04J
 14/02; H04J 2203/0025

See application file for complete search history.

D711,923 S 8/2014 Dallmeyer et al.
 D712,350 S 9/2014 Smith et al.
 D713,420 S 9/2014 Dallmeyer et al.
 D719,958 S 12/2014 Dallmeyer et al.
 D721,138 S * 1/2015 Barinaga D21/332
 D722,116 S * 2/2015 Gottschalk D21/332
 D726,729 S 4/2015 Lim
 D747,322 S 1/2016 Li
 D766,984 S 9/2016 Chatterjee et al.
 D766,985 S 9/2016 Chatterjee et al.
 D768,639 S 10/2016 Sumii
 D805,132 S * 12/2017 Sparks D21/332
 D805,133 S * 12/2017 Sparks D21/332

(56) **References Cited**

U.S. PATENT DOCUMENTS

D338,882 S 8/1993 Reiter
 D341,280 S 11/1993 Garmon
 D369,789 S 5/1996 Lucente, II et al.
 D393,451 S 4/1998 Faranda et al.
 D402,641 S 12/1998 Heijnen
 5,914,707 A 6/1999 Kono
 D412,319 S 7/1999 Lee et al.
 D415,740 S 10/1999 Lee et al.
 D415,741 S 10/1999 Lee et al.
 D416,547 S 11/1999 Lee et al.
 6,115,249 A * 9/2000 Cipolla G06F 1/1616
 248/688
 D435,272 S 12/2000 Swanson et al.
 D438,543 S 3/2001 Goto
 D441,759 S 5/2001 Goto
 D452,282 S 12/2001 Stewart et al.
 D452,495 S 12/2001 Murnaghan et al.
 D452,867 S 1/2002 Goto
 D454,136 S * 3/2002 Deuschle D14/447
 D458,269 S 6/2002 Goto
 6,565,444 B2 5/2003 Nagata et al.
 6,599,194 B1 * 7/2003 Smith A63F 13/12
 463/30
 D486,492 S 2/2004 Sheu et al.
 6,908,387 B2 * 6/2005 Hedrick G07F 17/0014
 463/31
 6,930,600 B1 8/2005 Hsieh
 6,941,181 B1 9/2005 Mathurin
 D524,242 S 7/2006 Adams et al.
 7,090,582 B2 8/2006 Danieli et al.
 D554,582 S 11/2007 Iseki
 D557,680 S 12/2007 Corsini
 D561,186 S 2/2008 Kawase
 D568,276 S 5/2008 Ikeda et al.
 D576,686 S 9/2008 Ashida et al.
 D606,094 S 12/2009 Kimura
 D610,625 S 2/2010 Guinchard et al.
 D641,024 S 7/2011 Zenri et al.
 D647,918 S 11/2011 Ledbetter et al.
 D650,448 S 12/2011 Zenri et al.
 D655,351 S 3/2012 Zenri et al.
 D656,555 S 3/2012 Zenri et al.
 D657,788 S 4/2012 Ledbetter et al.
 D664,993 S 8/2012 Ledbetter et al.
 D665,424 S 8/2012 Ledbetter et al.
 D666,680 S 9/2012 Mercier et al.
 D680,174 S 4/2013 Mercier et al.
 D685,795 S 7/2013 Paschke et al.
 D692,009 S 10/2013 Ashida et al.
 D692,437 S 10/2013 Sugino et al.
 D700,246 S 2/2014 Jacobs et al.
 D701,213 S 3/2014 Pajic
 D705,361 S 5/2014 Jacobs et al.
 D705,869 S * 5/2014 Jacobs D14/496
 D705,870 S 5/2014 Jacobs et al.
 D705,871 S 5/2014 Jacobs et al.
 D709,133 S 7/2014 Jacobs et al.
 D709,134 S 7/2014 Dallmeyer et al.
 D709,959 S * 7/2014 Jacobs D21/332

OTHER PUBLICATIONS

Aug. 21, 2017—U.S. Notice of Allowance—U.S. Appl. No. 29/564,511,
 filed May 13, 2016; Inv.: Bryan A. Sparks.
 Jan. 3, 2014—U.S. Notice of Allowance—U.S. Appl. No. 29/447,078,
 filed Feb. 28, 2013; Inv.: Joel B. Jacobs.
 Jan. 6, 2014—U.S. Non-Final Office Action—U.S. Appl. No.
 29/447,082, filed Feb. 28, 2013; Inv.: Joel B. Jacobs.
 Mar. 12, 2014—U.S. Notice of Allowance—U.S. Appl. No. 29/447,082,
 filed Feb. 28, 2013; Inv.: Joel B. Jacobs.
 Jan. 6, 2014—U.S. Notice of Allowance—U.S. Appl. No. 29/447,085,
 filed Feb. 28, 2013; Inv.: Joel B. Jacobs.
 Jan. 2, 2014—U.S. Requirement for Restriction—U.S. Appl. No.
 29/447,089, filed Feb. 28, 2013; Inv.: Joel B. Jacobs.
 Mar. 14, 2014—U.S. Notice of Allowance—U.S. Appl. No. 29/447,089,
 filed Feb. 28, 2013; Inv.: Joel B. Jacobs.
 Jan. 6, 2014—U.S. Notice of Allowance—U.S. Appl. No. 29/447,094,
 filed Feb. 28, 2013; Inv.: Joel B. Jacobs.
 Jan. 7, 2014—U.S. Notice of Allowance—U.S. Appl. No. 29/447,097,
 filed Feb. 28, 2013; Inv.: Joel B. Jacobs.
 Jan. 7, 2014—U.S. Notice of Allowance—U.S. Appl. No. 29/447,100,
 filed Feb. 28, 2013; Inv.: Joel B. Jacobs.
 Nov. 28, 2016—U.S. Non-Final Office Action—U.S. Appl. No.
 29/564,514, filed May 13, 2016; Inv.: Bryan A Sparks.
 Apr. 5, 2017—U.S. Final Office Action—U.S. Appl. No. 29/564,514,
 filed: May 13, 2016; Inv.: Bryan A Sparks.
 Aug. 23, 2017—U.S. Notice of Allowance—U.S. Appl. No. 29/564,514,
 filed May 13, 2016; Inv.: Bryan A Sparks.
 Apr. 5, 2017—U.S. Final Office Action—U.S. Appl. No. 29/564,518,
 filed May 13, 2016; Inv.: Bryan A Sparks.
 Aug. 23, 2017—U.S. Notice of Allowance—U.S. Appl. No. 29/564,518,
 filed May 13, 2016; Inv.: Bryan A Sparks.
 Apr. 5, 2017—U.S. Final Office Action—U.S. Appl. No. 29/564,522,
 filed May 13, 2016; Inv.: Bryan A Sparks.
 Aug. 23, 2017—U.S. Notice of Allowance—U.S. Appl. No. 29/564,522,
 filed May 13, 2016; Inv.: Bryan A Sparks.
 Apr. 21, 2017—U.S. Non-Final Office Action—U.S. Appl. No.
 29/566,652, filed Jun. 1, 2016; Inv.: Bryan A Sparks.
 Sep. 13, 2017—U.S. Notice of Allowance—U.S. Appl. No. 29/566,652,
 filed Jun. 1, 2016; Inv.: Bryan A Sparks.
 Jun. 1, 2017—U.S. Non-Final Office Action—U.S. Appl. No.
 29/564,601, filed May 13, 2016; Inv.: Bryan A Sparks.
 Apr. 5, 2017—U.S. Final Office Action—U.S. Appl. No. 29/564,527,
 filed May 13, 2016; Inv.: Bryan A Sparks.
 Aug. 23, 2017—U.S. Notice of Allowance—U.S. Appl. No. 29/564,527,
 filed May 13, 2016; Inv.: Bryan A Sparks.
 Way Back Machine [online], [retrieved Jan. 16, 2013]. Retrieved
 from internet, <http://web.archive.org/web/20130116120917/http://www.klipsch.com/gallery-g17-air>.
 Nintendo NES [online], [retrieved on May 14, 2013]. Retrieved
 from internet, <http://gamesdbase.com/system-nintendo_nes.aspx/
 >. “Nintendo Wii Review”, Top 10 Reviews ; URL: <<http://www.toptenreviews.com/electronics/gaming/best-video-game-consoles/nintendo-wii/review/>> ; date accessed Sep. 27, 2016.
 “PS4 Console”, PS4 Features, Games & Videos ; <URL:<https://www.playstation.com/en-us/explore/ps4/>> ; date accessed Sep. 27,
 2016.

(56)

References Cited

OTHER PUBLICATIONS

“Sony Playstation 2”, The Video Game Critic’s Console Reviews ; <URL:<http://videogamecritic.com/ps2info.htm>> ; date accessed Sep. 27, 2016.

X Box One S found online [Nov. 12, 2016] http://www.xbox.com/en-US/xbox-one-s?&ocid=PORTALS_SEM_google_microsoft%20xbox&cid=PORTALS_SEM_google_microsoft%20xbox.

Nov. 30, 2016—U.S. Non-Final Office Action—U.S. Appl. No. 29/564,527, filed May 13, 2016; Inv.: Bryan A. Sparks.

Nov. 30, 2016—U.S. Non-Final Office Action—U.S. Appl. No. 29/564,511, filed May 13, 2016; Inv.: Bryan A. Sparks.

Nov. 28, 2016—U.S. Non-Final Office Action—U.S. Appl. No. 29/564,518, filed May 13, 2016; Inv.: Bryan A. Sparks.

Nov. 30, 2016—U.S. Non-Final Office Action—U.S. Appl. No. 29/564,522, filed May 13, 2016; Inv.: Bryan A. Sparks.

AVS Forum; “Receivers, Amps, and Processors”; Publication date unknown but prior to filing of present application; Date Accessed: Jul. 25, 2017; URL: <<http://www.avforum.com/forum/90-receivers-amps-processors/1502957-onkyo-tx-sr601-any-good.html>>.

Ixbt.com; “DolbyDigital Surround EX, DTS-ES 6.1”; Publication date unknown but prior to filing date of present application; Date Accessed: Jul. 25, 2017; URL: <<http://www.ixbt.com/dvd/onkyo-tx-sr-600.shtml>>.

Grey Ghost; “Insignia NS-R2000 Stereo Receiver Review”; Publication date unknown but prior to filing date of present application; Date Accessed: Jul. 25, 2017; URL: <<http://greyghost.mooo.com/nsr2000-review/>>.

Crutch Field; “Cambridge Audio Topaz SR20”; Publication date unknown but prior to filing date of present application; Date Accessed: Jul. 25, 2017; URL: <https://www1.crutchfield.com/p_779SR20/Cambridge-Audio-Topaz-SR20.html>.

Stereophile; “Arcam FMJ SR250 stereo AV receiver”; Publication date: Jun. 1, 2017; Date Accessed: Jul. 25, 2017; URL: <<https://www.stereophile.com/taxonomy/term-p/143>>.

Electronic House; “Affordable 2-channel Receivers for Great Home Stereo Systems”; Publication date: Apr. 1, 2015; Date Accessed: Jul. 25, 2017; URL: <<https://www.electronichouse.com/home-audio/affordable-2-channel-receivers-great-home-stereo-systems/>>.

Audi Affair; “Arcam FMJ C49 Pre Amplifier”; Publication date unknown but prior to filing date; Date accessed: Jul. 25, 2017; URL: <<http://www.audioaffair.co.uk/arcam-c49-pre-amplifier>>.

Hifi-Prestige; “Arcam FMJ A 39”; Publication date unknown but prior to filing date; Date Accessed: Jul. 25, 2017; URL: <<http://www.hifiprestige.it/it/amplificatori-integrati/7517-arcam-fmj-a-39.html>>.

Hifi-Prestige; “Arcam FMJ AVR 550”; Publication date unknown but prior to filing date; Date Accessed: Jul. 25, 2017; URL: <<http://www.hifiprestige.it/it/sintoamplificatori-a-v/9343-arcam-fmj-avr-550.html>>.

Hifi-Prestige; “Arcam FMJ C 49”; Publication date unknown but prior to filing date; Date Accessed: Jul. 25, 2017; URL: <<http://www.hifiprestige.it/it/preamplificatori/7514-arcam-fmj-c-49.html>>.

Hifi-Prestige; “Arcam FMJ UDP 411”; Publication date unknown but prior to filing Date Accessed: Jul. 25, 2017; URL: <<http://www.hifiprestige.it/it/accessori-multimediali/7519-arcam-fmj-udp-411.html>>.

Hifi-Prestige; “Arcam FMJ A19 Black—Amplificatore Integrato”; Publication date unknown but prior to filing date; Date Accessed: Jul. 25, 2017; URL: <<http://www.hifiprestige.it/it/amplificatori-integrati/6523-arcam-fmj-a19-black.html>>.

Best Buy; “Insignia—200W 2.0-Ch. Stereo Receiver—Black”; Publication date unknown but prior to filing date; Date Accessed: Jul. 25, 2017; URL: <<http://www.bestbuy.com/site/insignia-200w-2-0-ch-stereo-receiver-black/4156007.p?skuId=4156007>>.

Best Buy; “Yamaha—165W 2.0-Ch. Stereo Receiver—Black”; Publication date unknown but prior to filing date; Date Accessed: Jul. 25, 2017; URL: <<http://www.bestbuy.com/site/yamaha-165w-2-0-ch-stereo-receiver-black/3817026.p?skuId=3817026>>.

Best Buy; “Denon—AVR 5.2-Ch. 4K Ultra HD and 3D Pass-Through A/V Home Theater Receiver—Black”; Publication date unknown but prior to filing date; Date Accessed: Jul. 25, 2017; URL: <<http://www.bestbuy.com/site/denon-avr-5-2-ch-4k-ultra-hd-and-3d-pass-through-a-v-home-theater-receiver-black/5756606.p?skuId=5756606>>.

Best Buy; “Yamaha—5.1-Ch. 4K Ultra HD and 3D Pass-Through A/V Home Theater Receiver—Black”; Publication date unknown but prior to filing date; Date Accessed: Jul. 25, 2017; URL: <<http://www.bestbuy.com/site/yamaha-5-1-ah-4k-ultra-hd-and-3d-pass-through-a-v-home-theater-receiver-black/5784593.p?skuId=5784593>>.

* cited by examiner

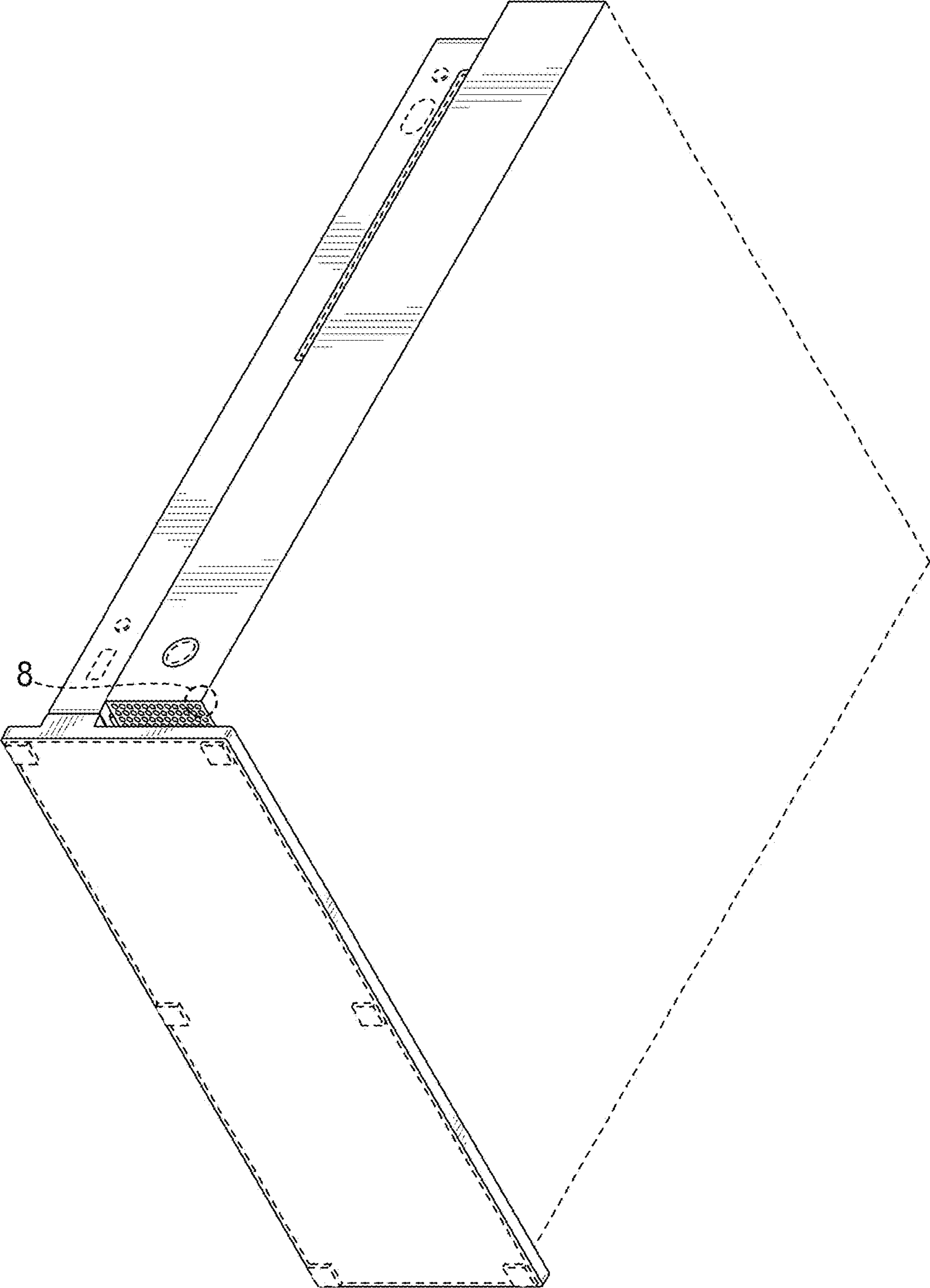

FIG. 1

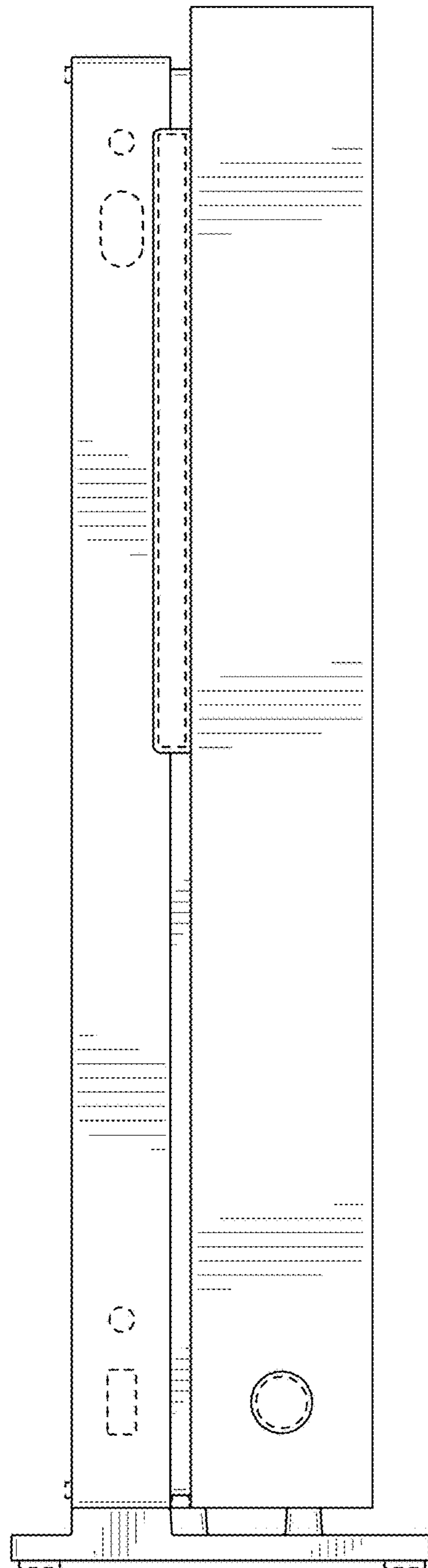

FIG. 2

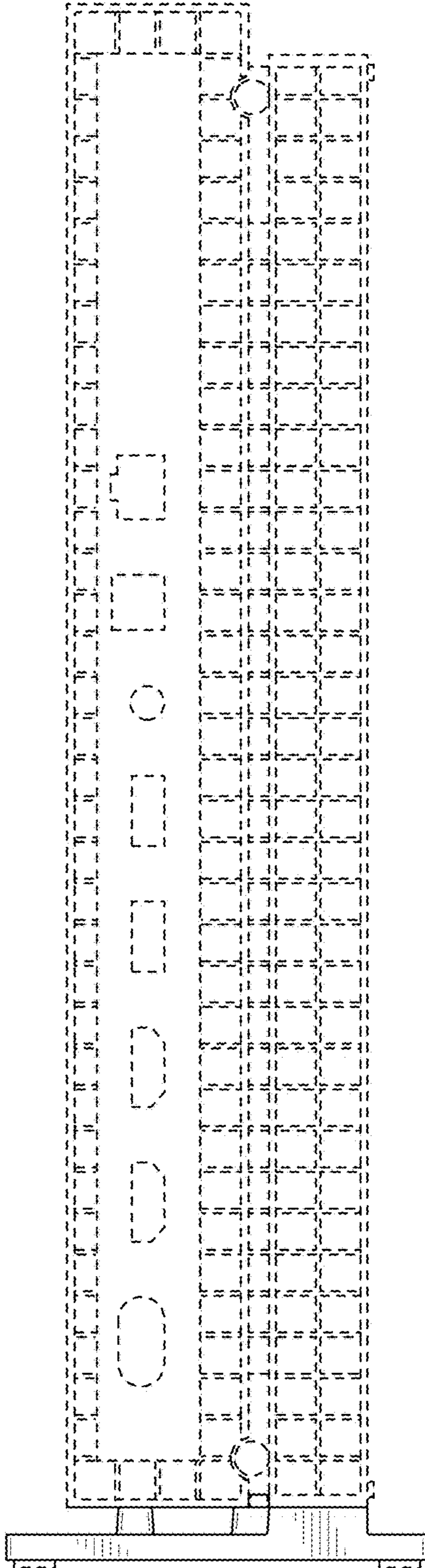

FIG. 3

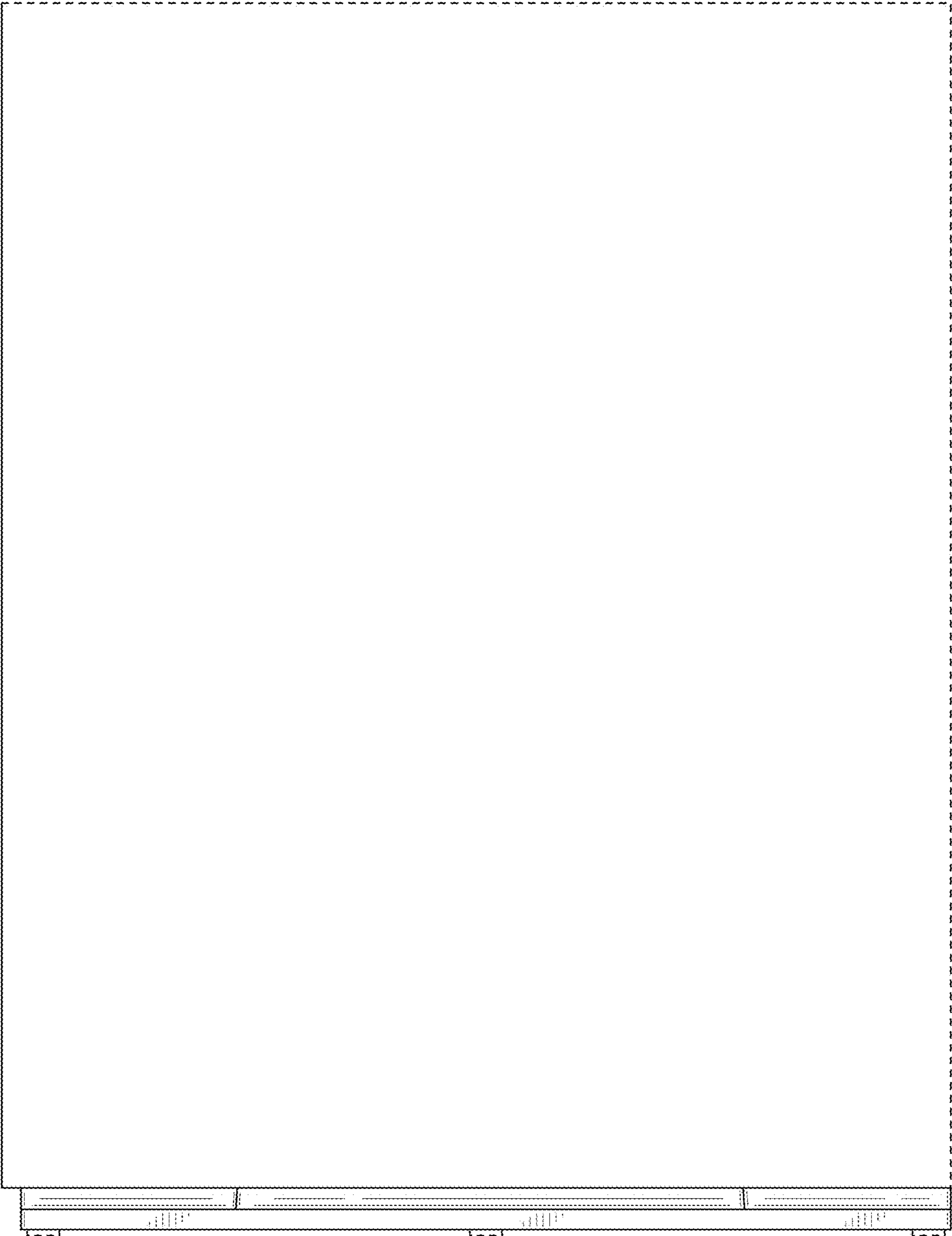

FIG. 4

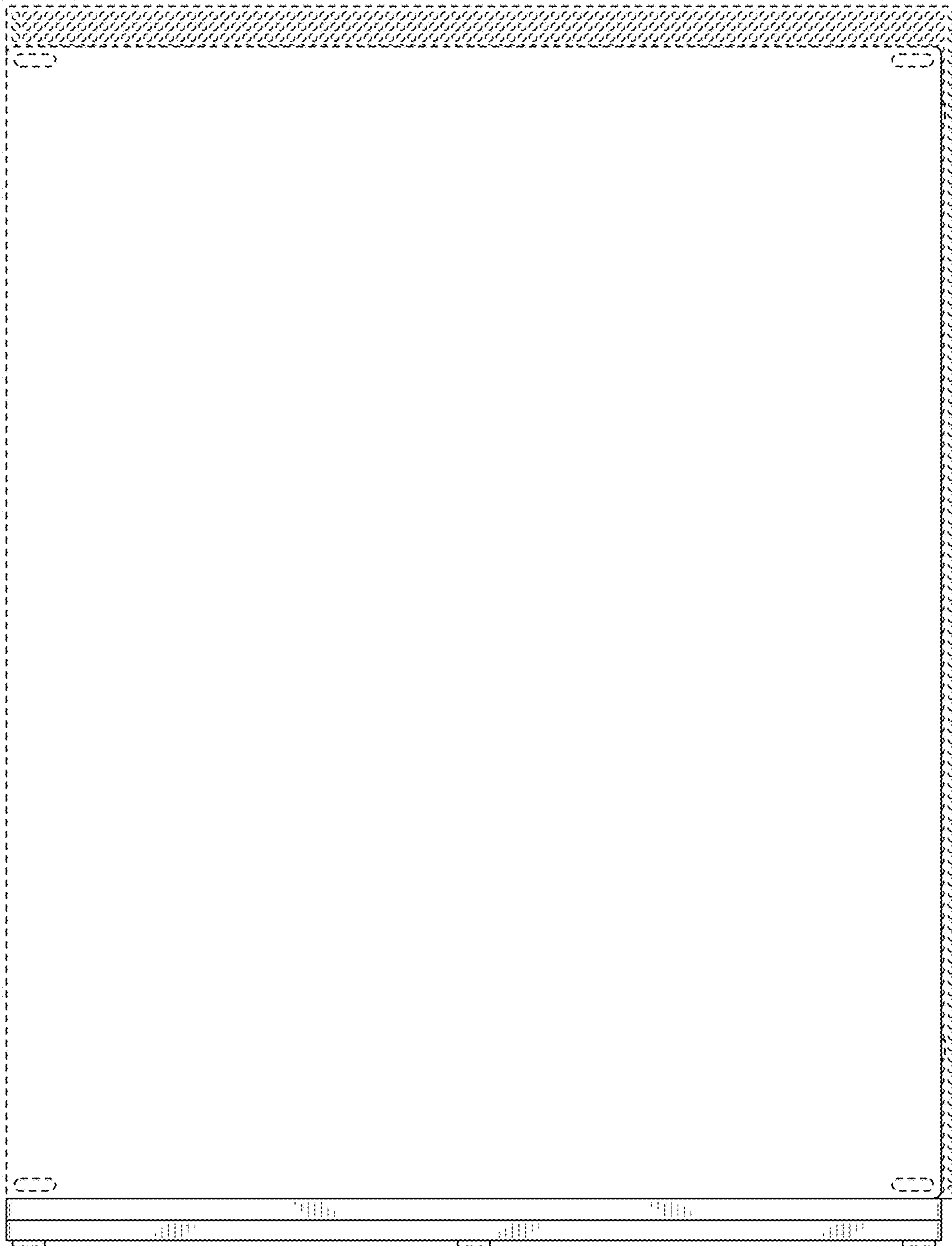

FIG. 5

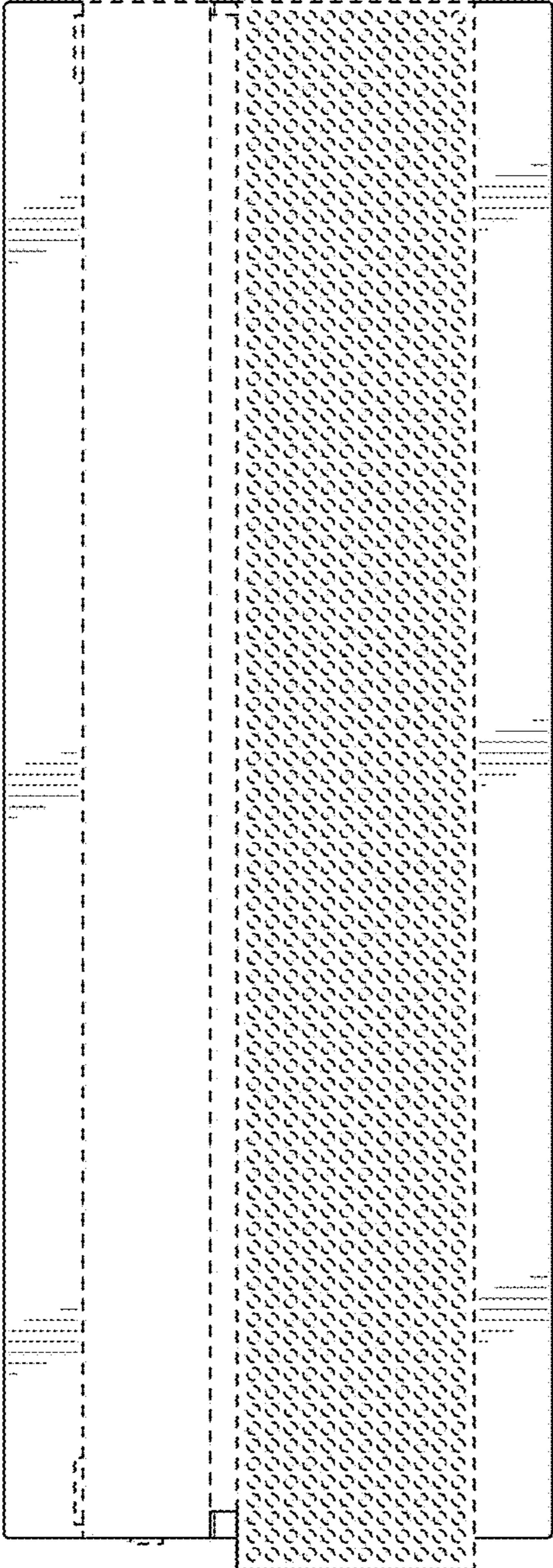

FIG. 6

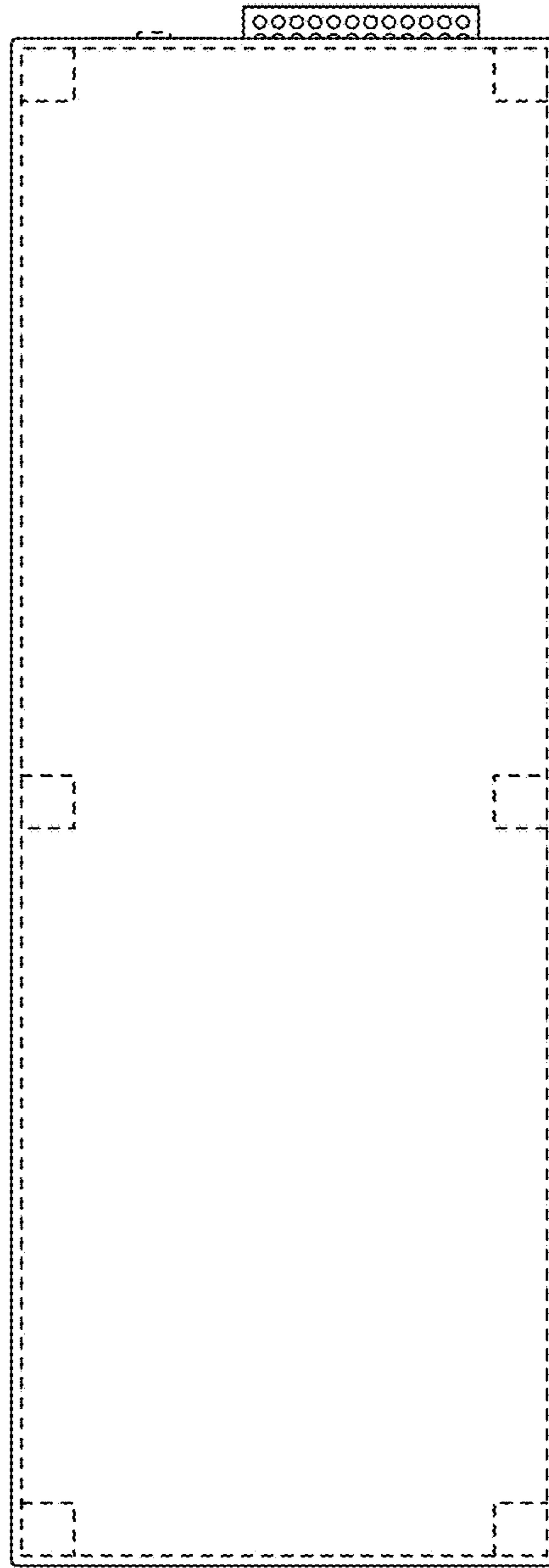

FIG. 7

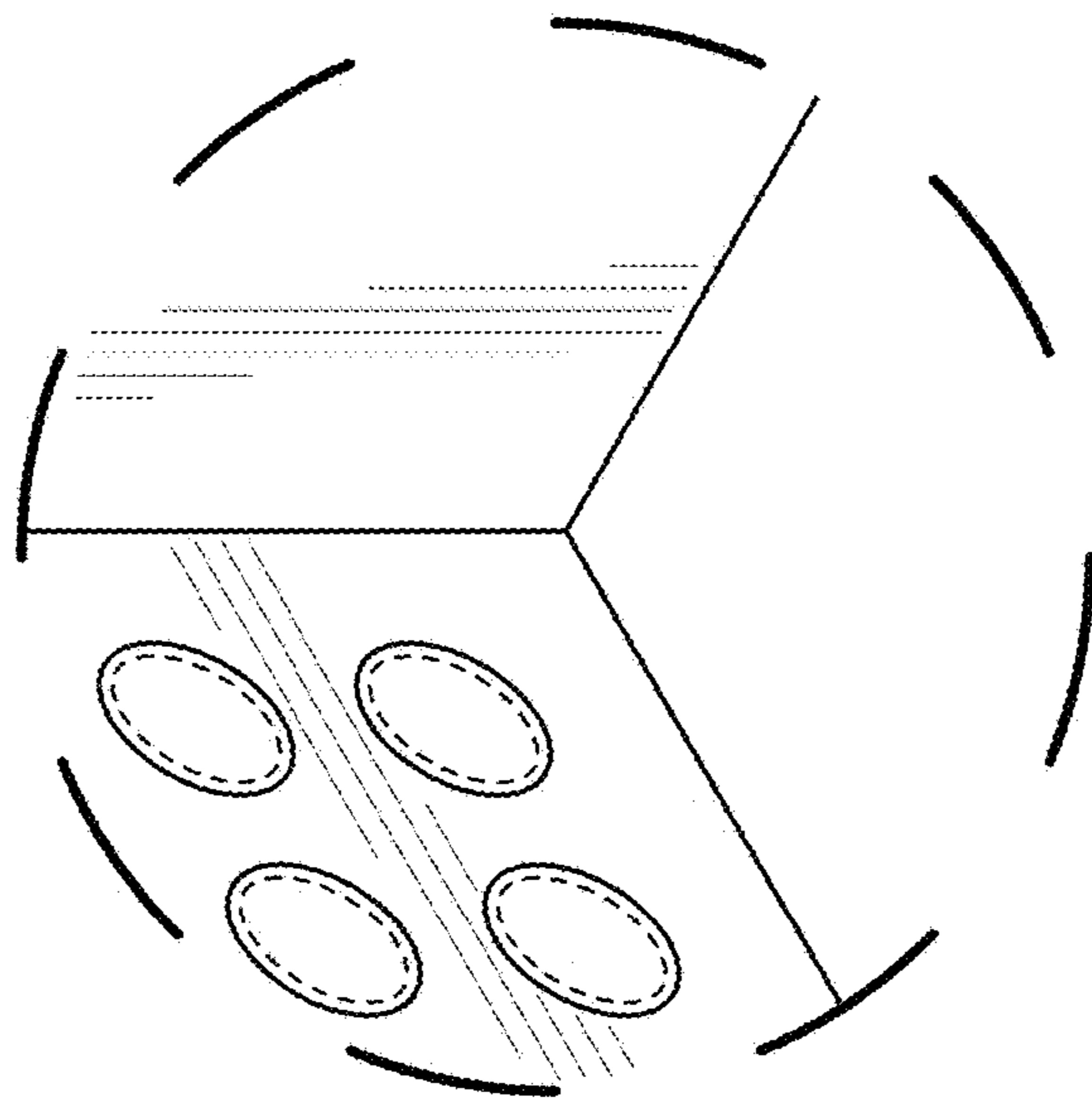

FIG. 8

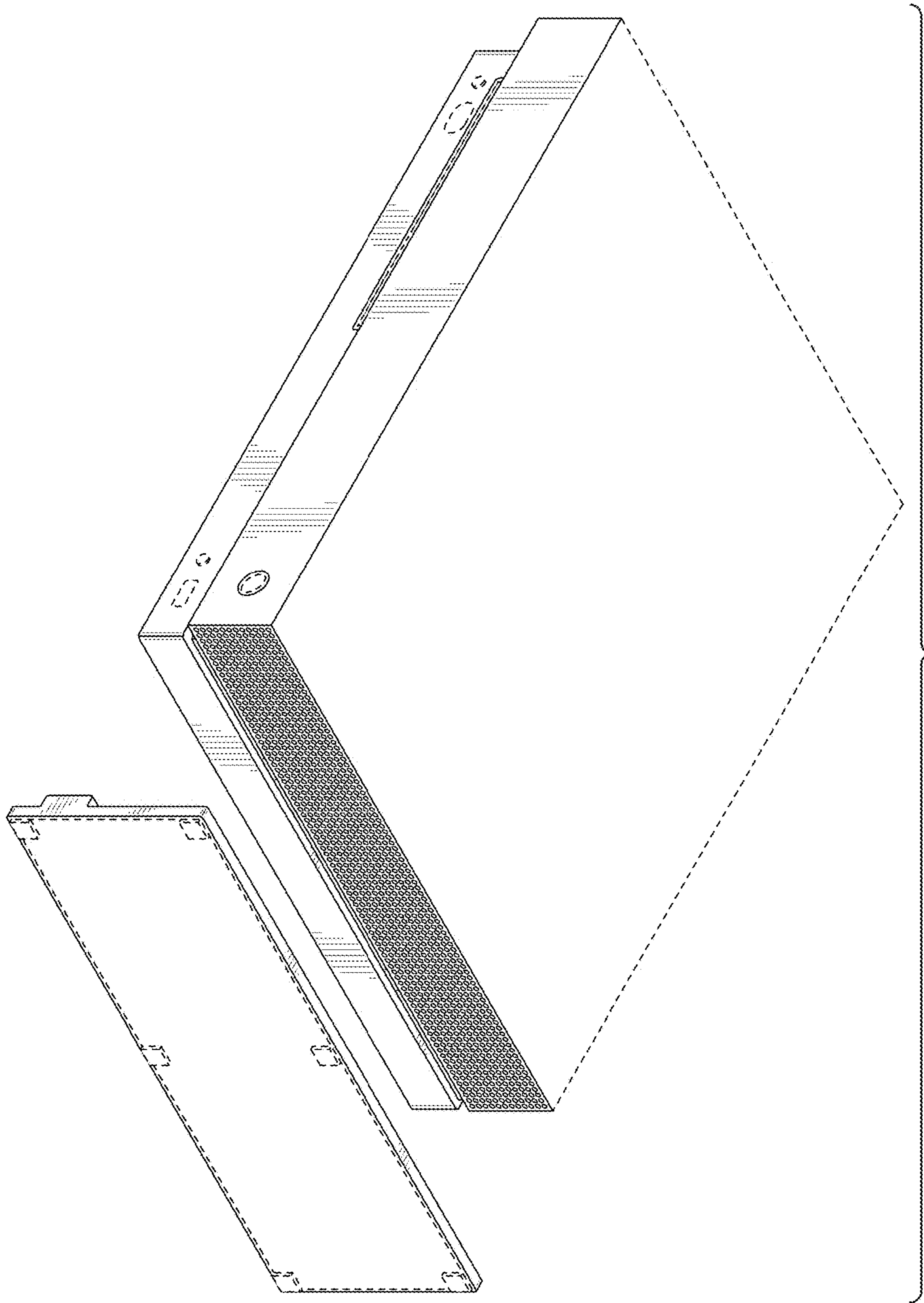

FIG. 9

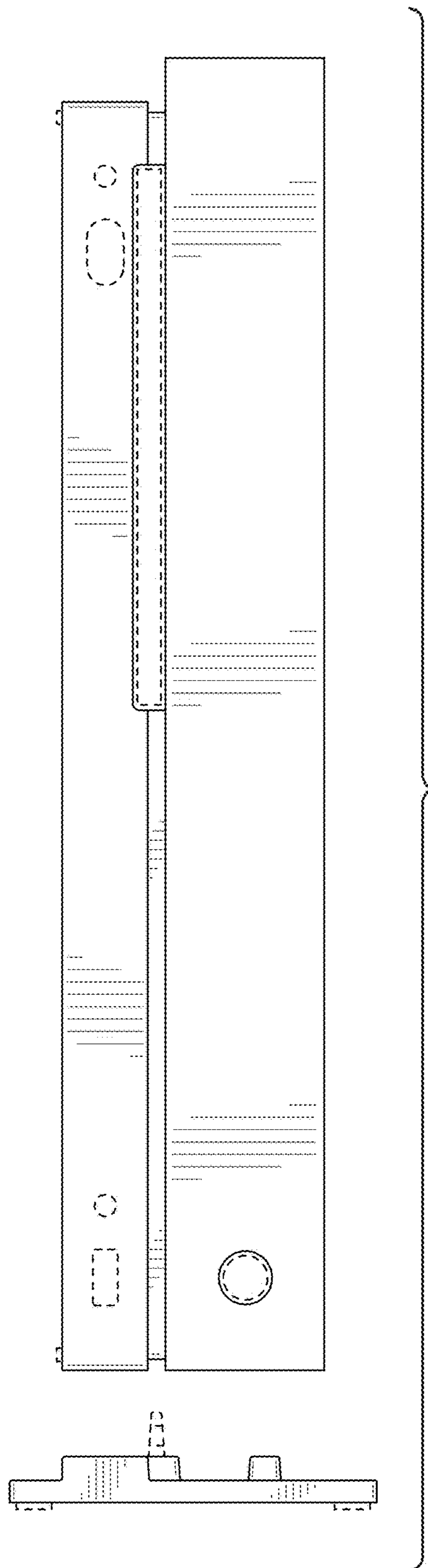

FIG. 10

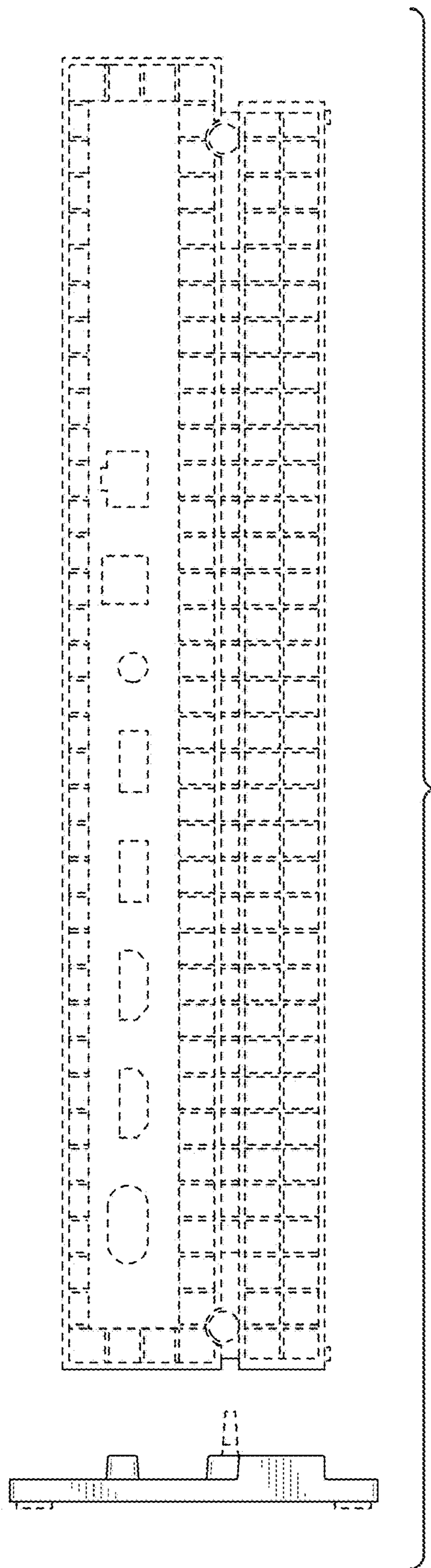

FIG. 11

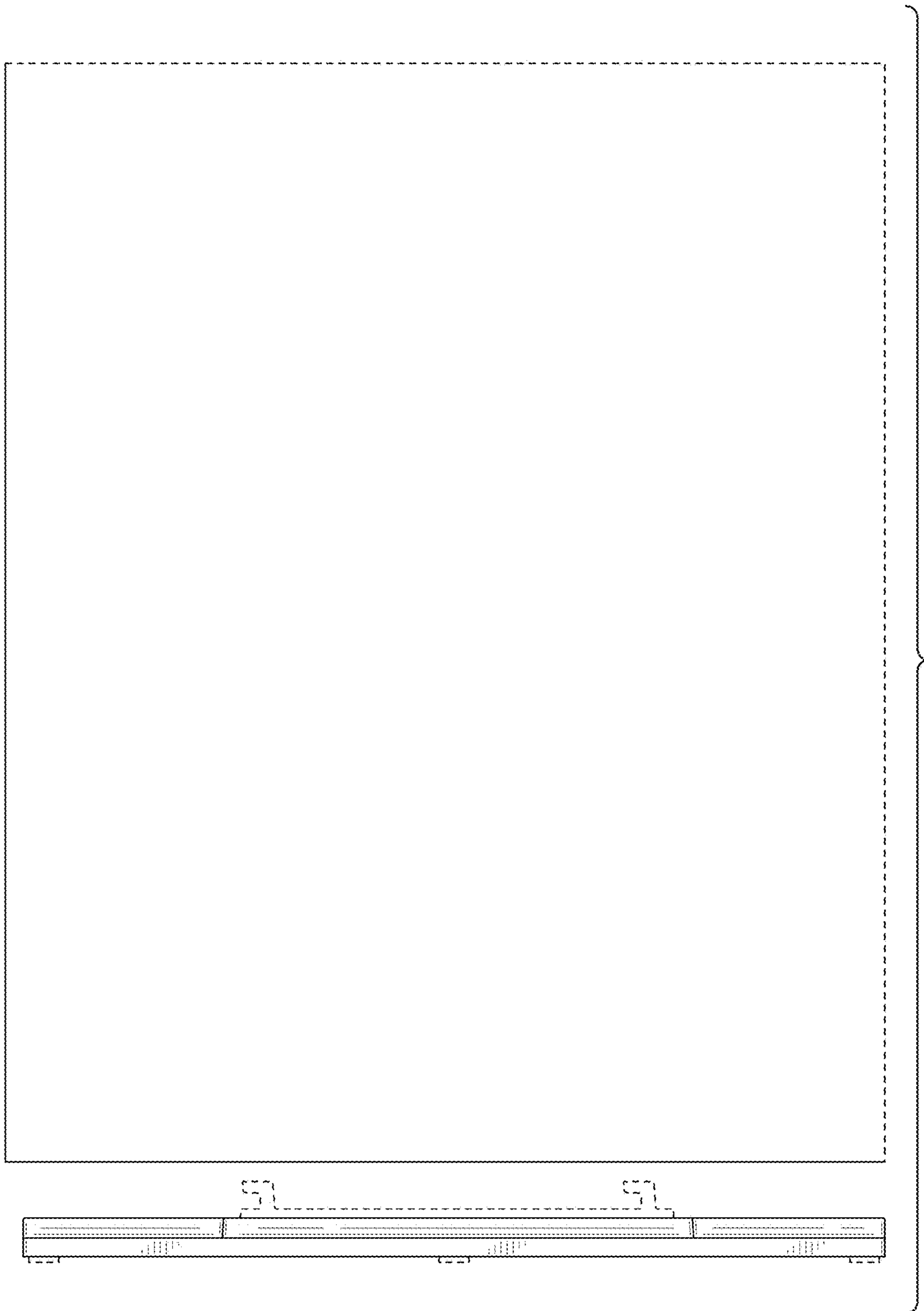

FIG. 12

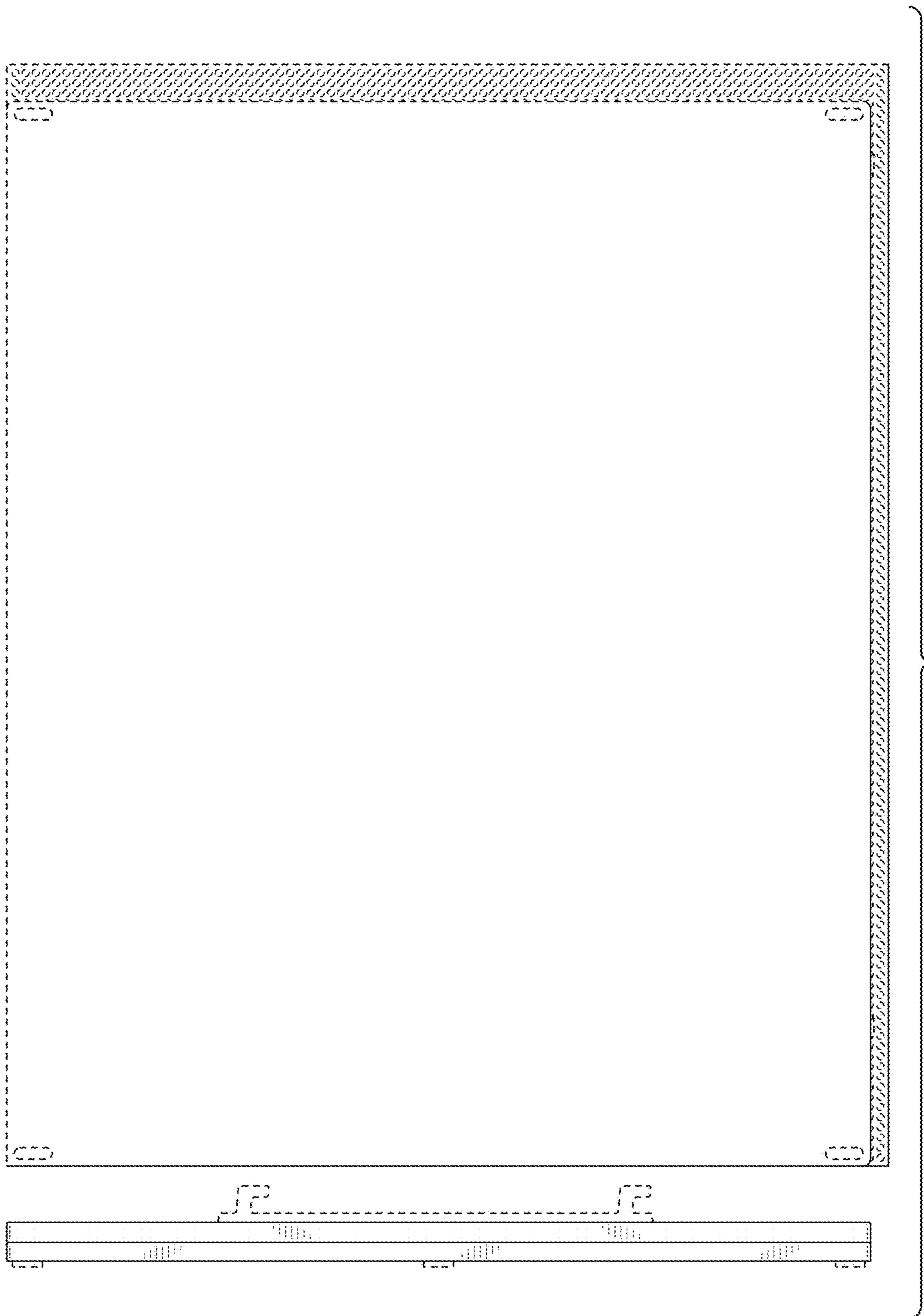

FIG. 13

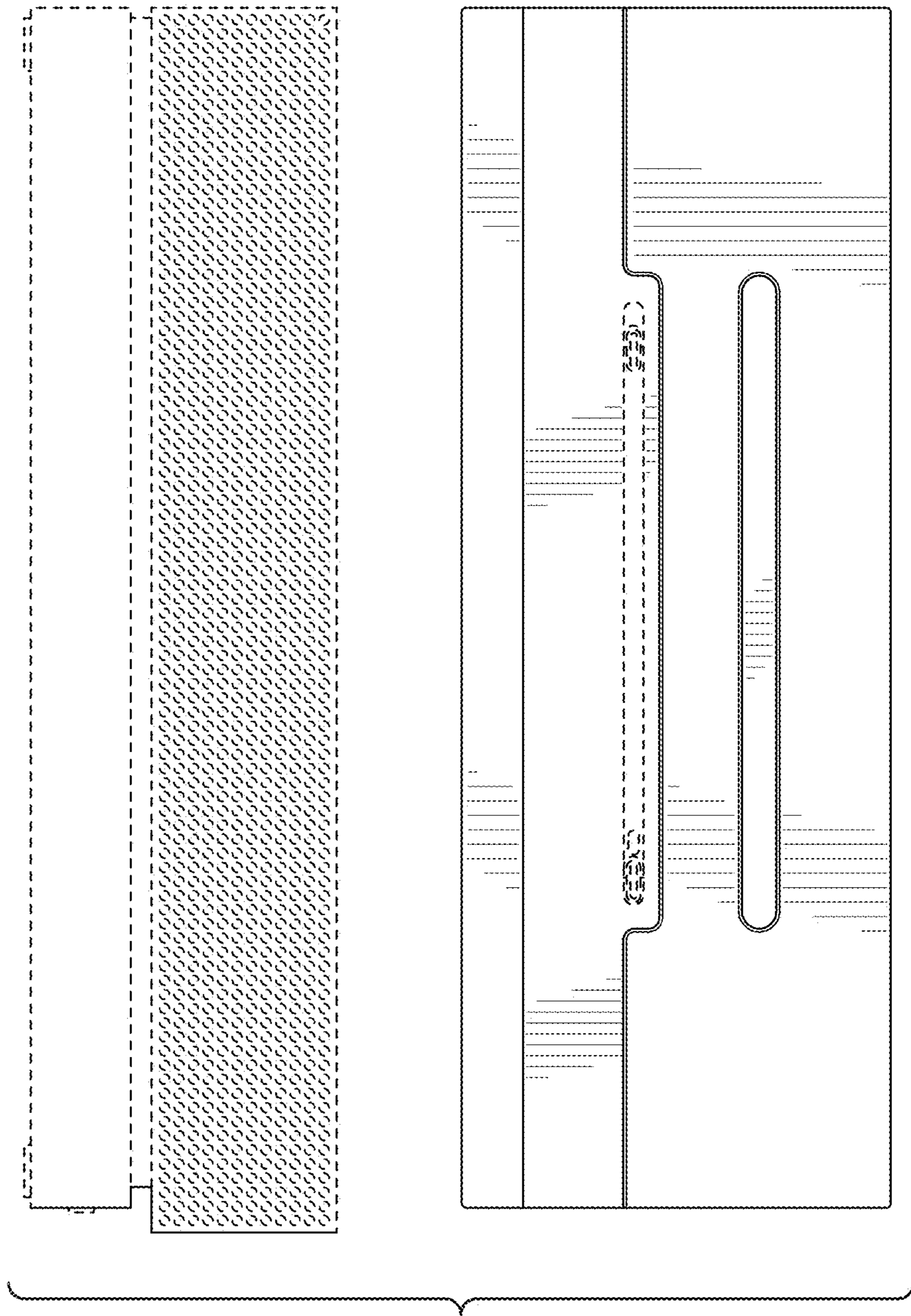

FIG. 14

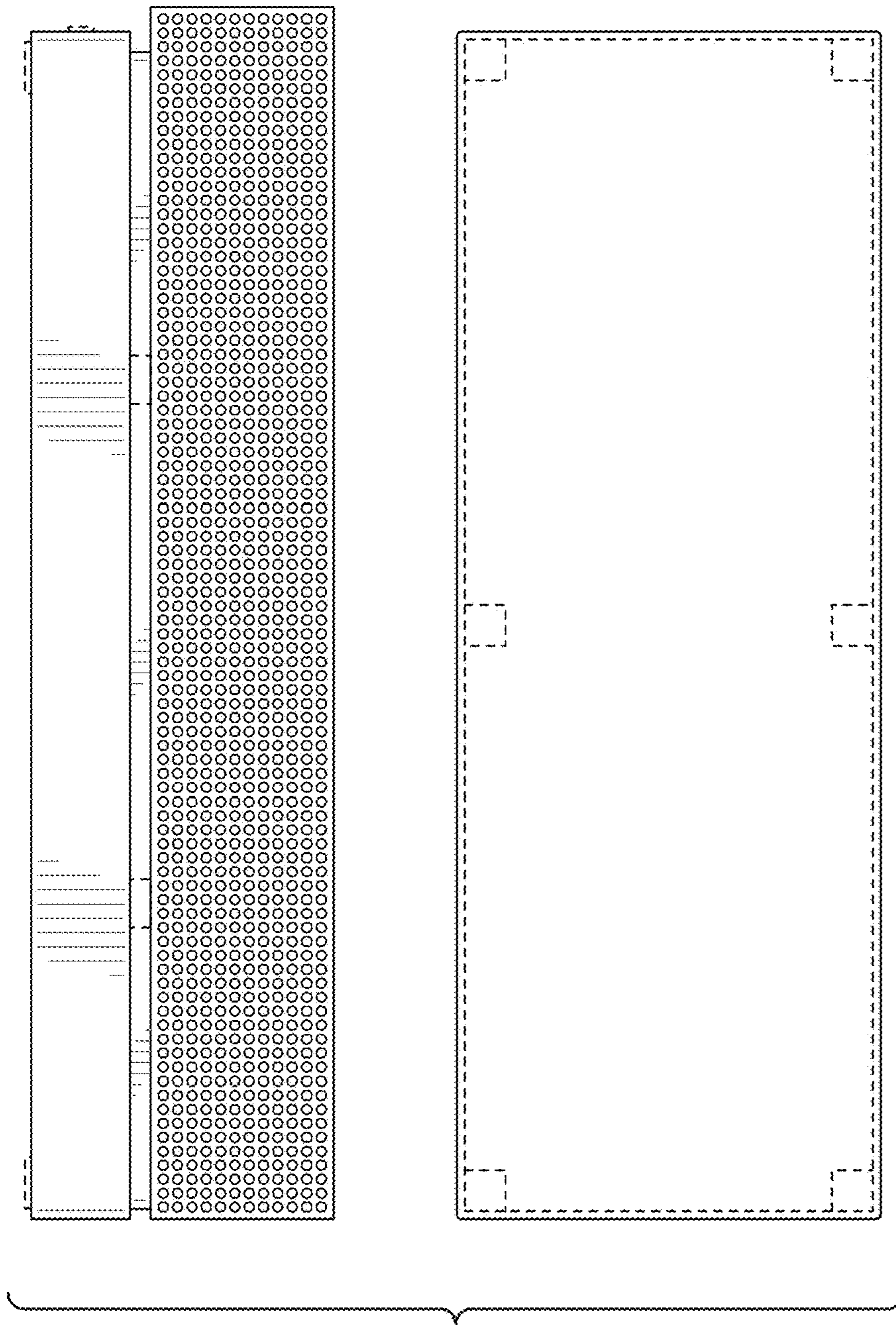

FIG. 15