



US00D839218S

(12) **United States Design Patent**
Tio

(10) **Patent No.:** **US D839,218 S**

(45) **Date of Patent:** **** Jan. 29, 2019**

(54) **CONTROL MODULE COOLING FAN**

(71) Applicant: **Rockwell Automation Technologies, Inc.**, Mayfield Heights, OH (US)

(72) Inventor: **Donald Yuen Leong Tio**, Singapore (SG)

(73) Assignee: **Rockwell Automation Technologies, Inc.**, Mayfield Heights, OH (US)

(**) Term: **15 Years**

(21) Appl. No.: **29/593,968**

(22) Filed: **Feb. 14, 2017**

Related U.S. Application Data

(62) Division of application No. 29/519,538, filed on Mar. 5, 2015, now Pat. No. Des. 781,253.

(51) **LOC (11) Cl.** **13-03**

(52) **U.S. Cl.**
USPC **D13/179**

(58) **Field of Classification Search**
USPC D13/110, 123, 162, 162.1, 179
CPC .. H02K 9/02; H02K 9/04; H02K 5/00; H02K 5/02; H02K 11/0073; H02P 27/04; H02P 29/0044; H02P 29/045; H05K 7/1432
See application file for complete search history.

(56) **References Cited**

U.S. PATENT DOCUMENTS

D631,436 S	1/2011	Huang	
8,072,174 B2	12/2011	Campbell et al.	
D653,616 S	2/2012	Choi	
D654,024 S	2/2012	Choi	
D720,690 S	1/2015	Tio et al.	
D723,463 S	3/2015	Tio et al.	
D781,253 S *	3/2017	Tio	D13/179

2013/0169079 A1	7/2013	Andrikowich et al.
2014/0084837 A1	3/2014	Tio et al.
2014/0103756 A1	4/2014	Grillenberger et al.
2014/0154098 A1	6/2014	Cardo
2015/0091393 A1	4/2015	Hayner et al.
2016/0043611 A1	2/2016	Ikeda et al.

* cited by examiner

Primary Examiner — Selina Sikder

(74) *Attorney, Agent, or Firm* — Fletcher Yoder, P.C.

(57) **CLAIM**

The ornamental design for a control module cooling fan, as shown and described.

DESCRIPTION

FIG. 1 is a front top perspective view of a cooling fan disposed in a control module showing my new design; FIG. 2 is another front top perspective view of the control module of FIG. 1; FIG. 3 is a front top perspective view of the cooling fan disconnected from the control module of FIG. 1; FIG. 4 is a front elevational view of the control module of FIG. 1; FIG. 5 is a left side elevational view of the control module of FIG. 1; FIG. 6 is a right side elevational view of the cooling fan disposed in the control module of FIG. 1; FIG. 7 is a right side elevational view of the control module of FIG. 1 with the cooling fan removed; FIG. 8 is a top plan view of the control module of FIG. 1; FIG. 9 is a bottom plan view of the control module of FIG. 1; and, FIG. 10 is a rear elevational view of the control module of FIG. 1.

The broken lines shown in the drawing views show portions of the article that form no part of the claimed design.

1 Claim, 9 Drawing Sheets

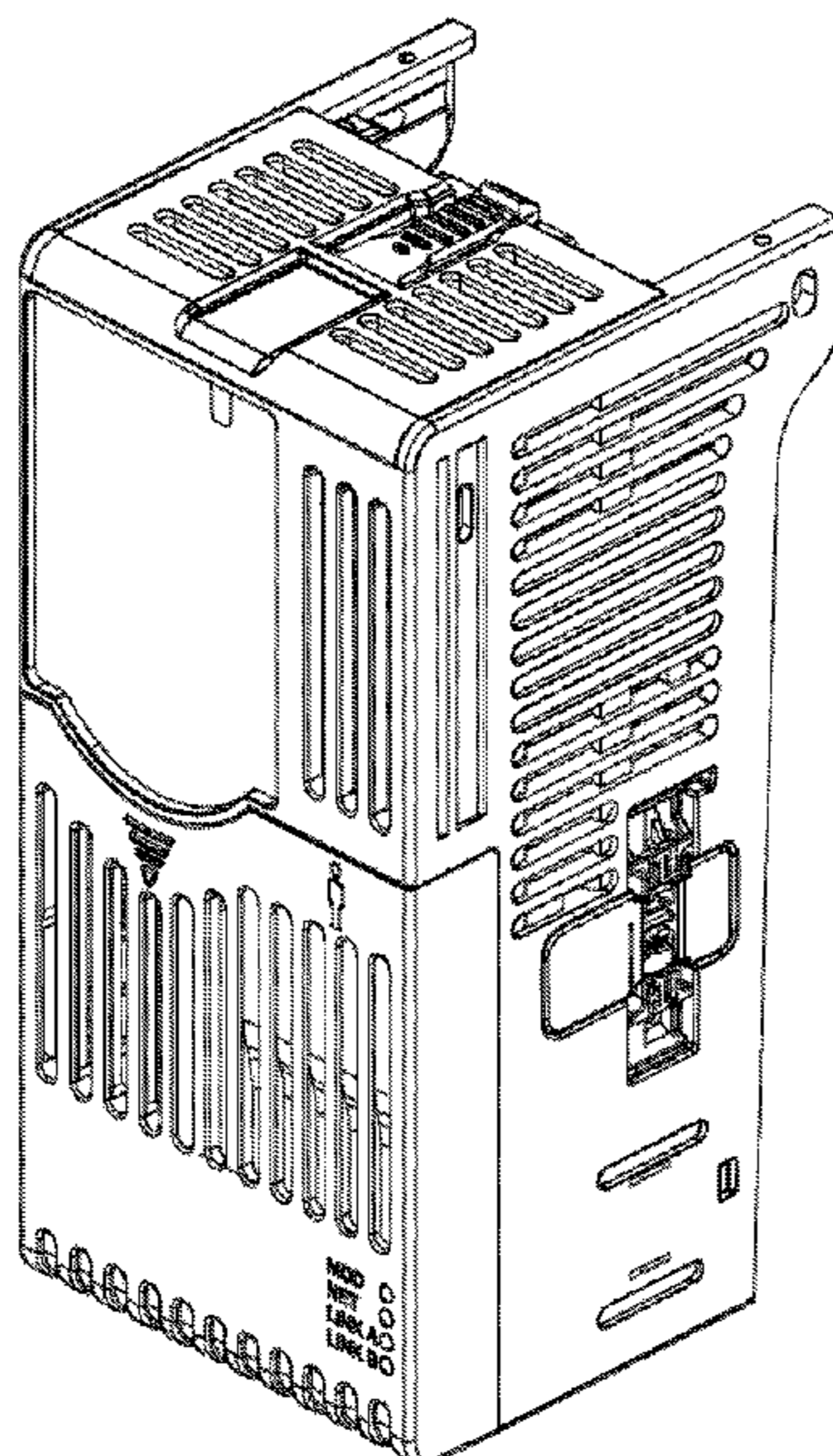

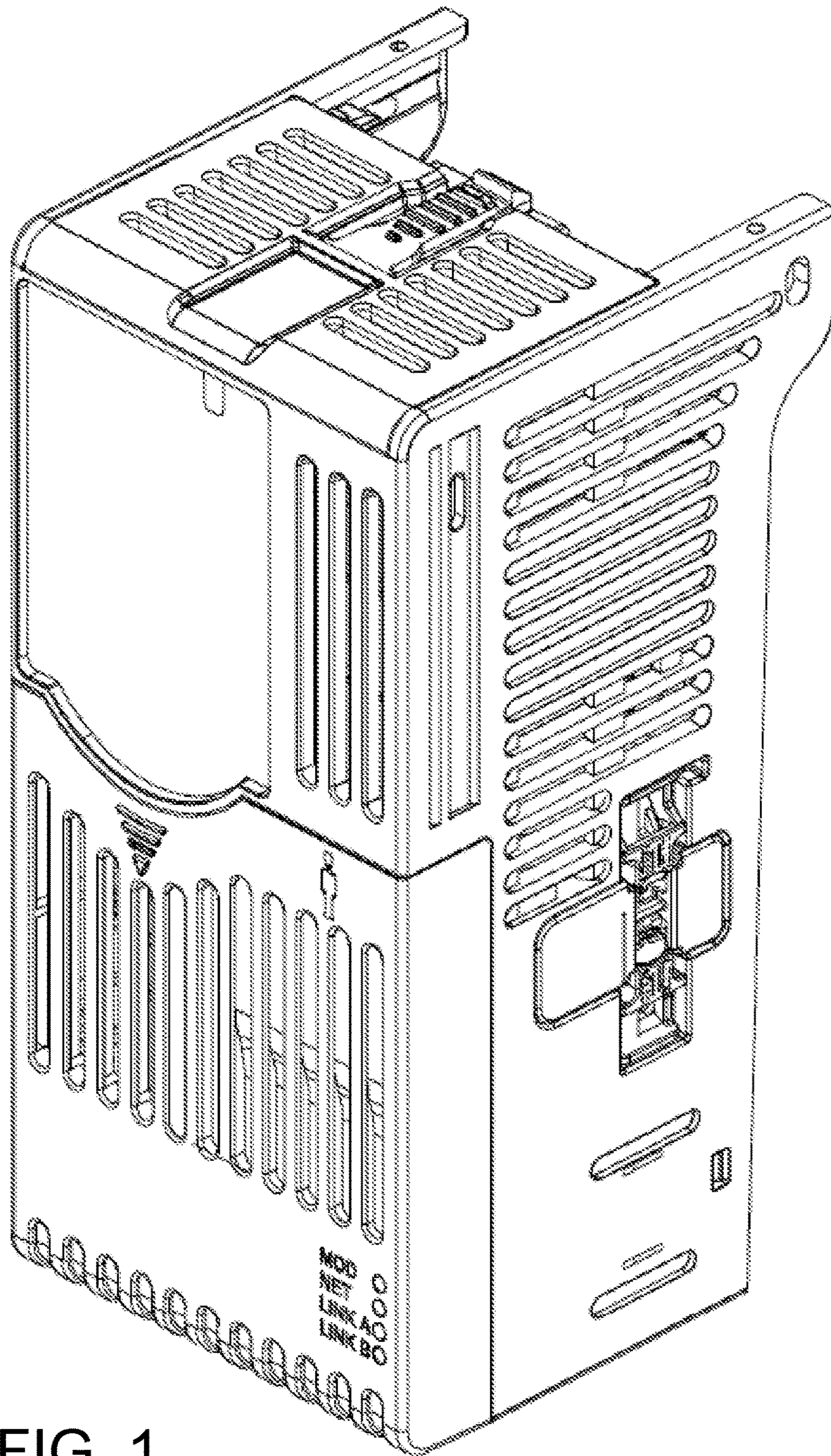

FIG. 1

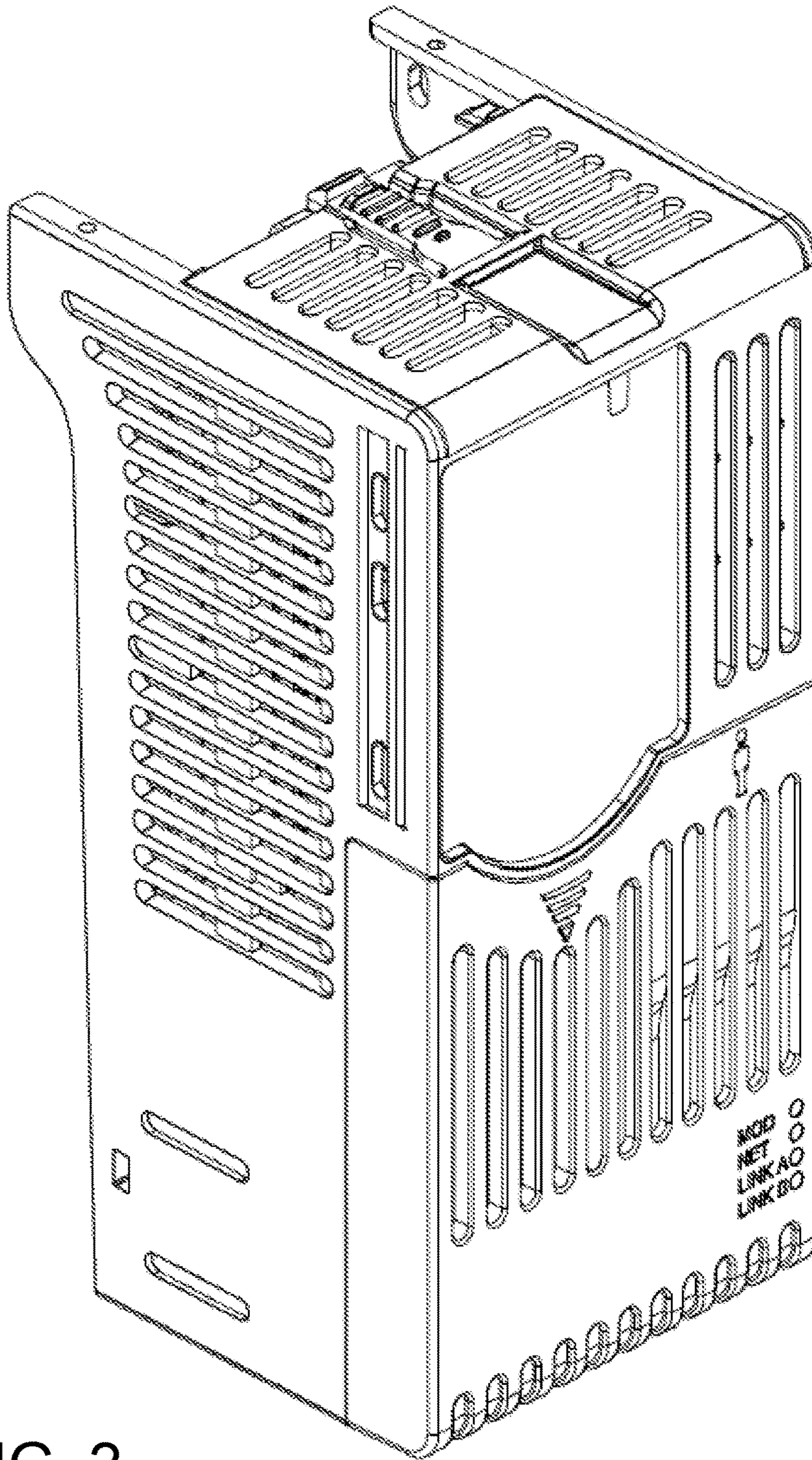

FIG. 2

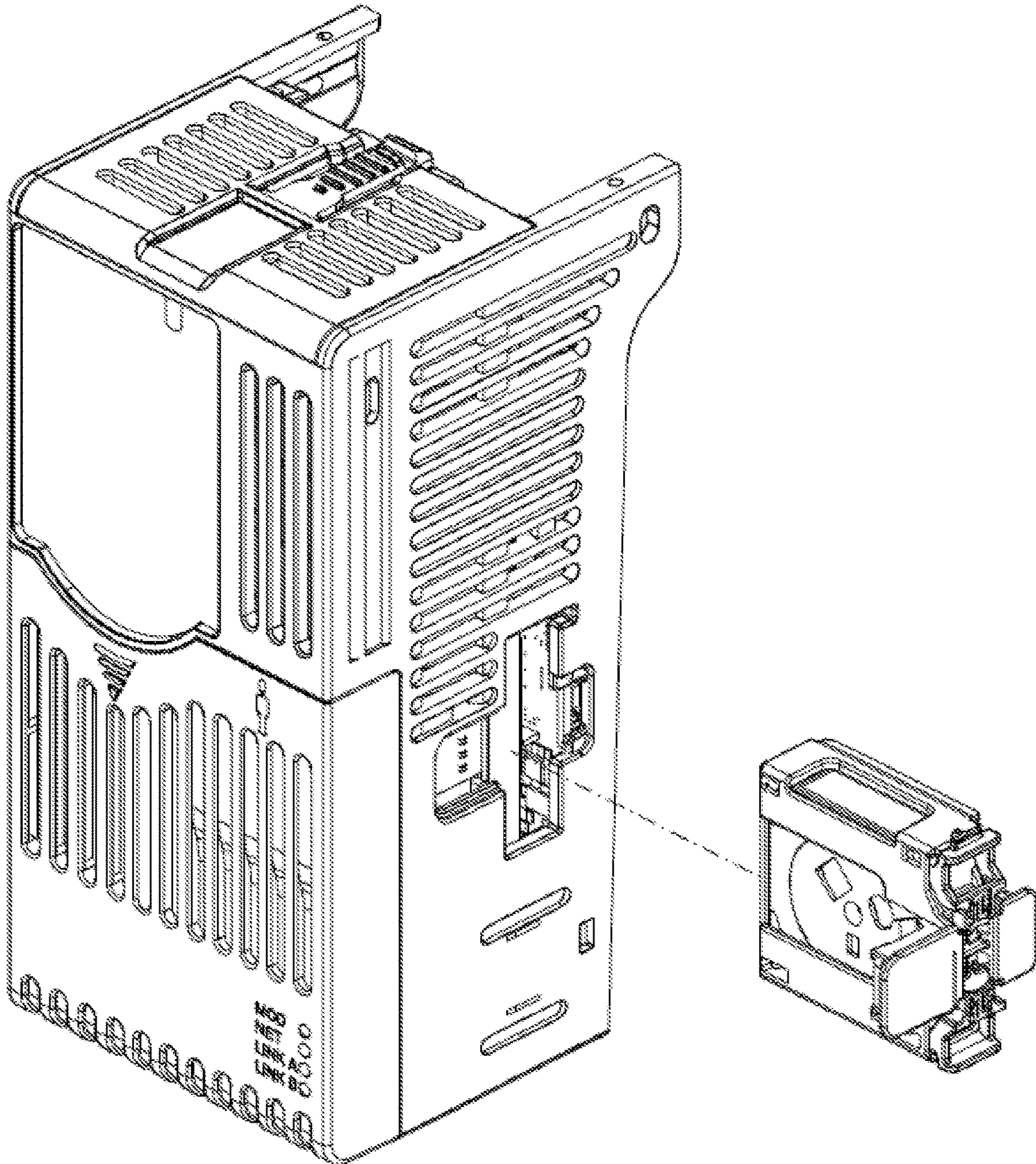

FIG. 3

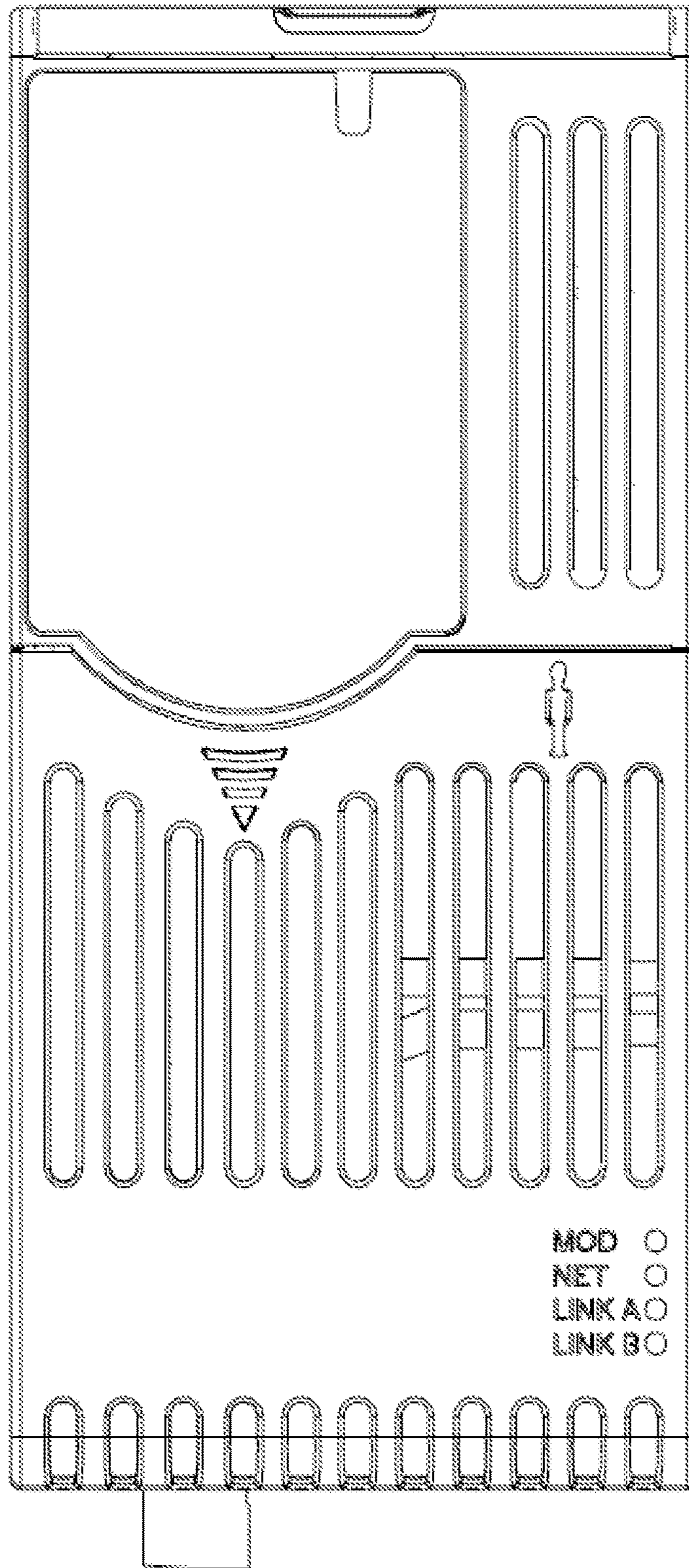

FIG. 4

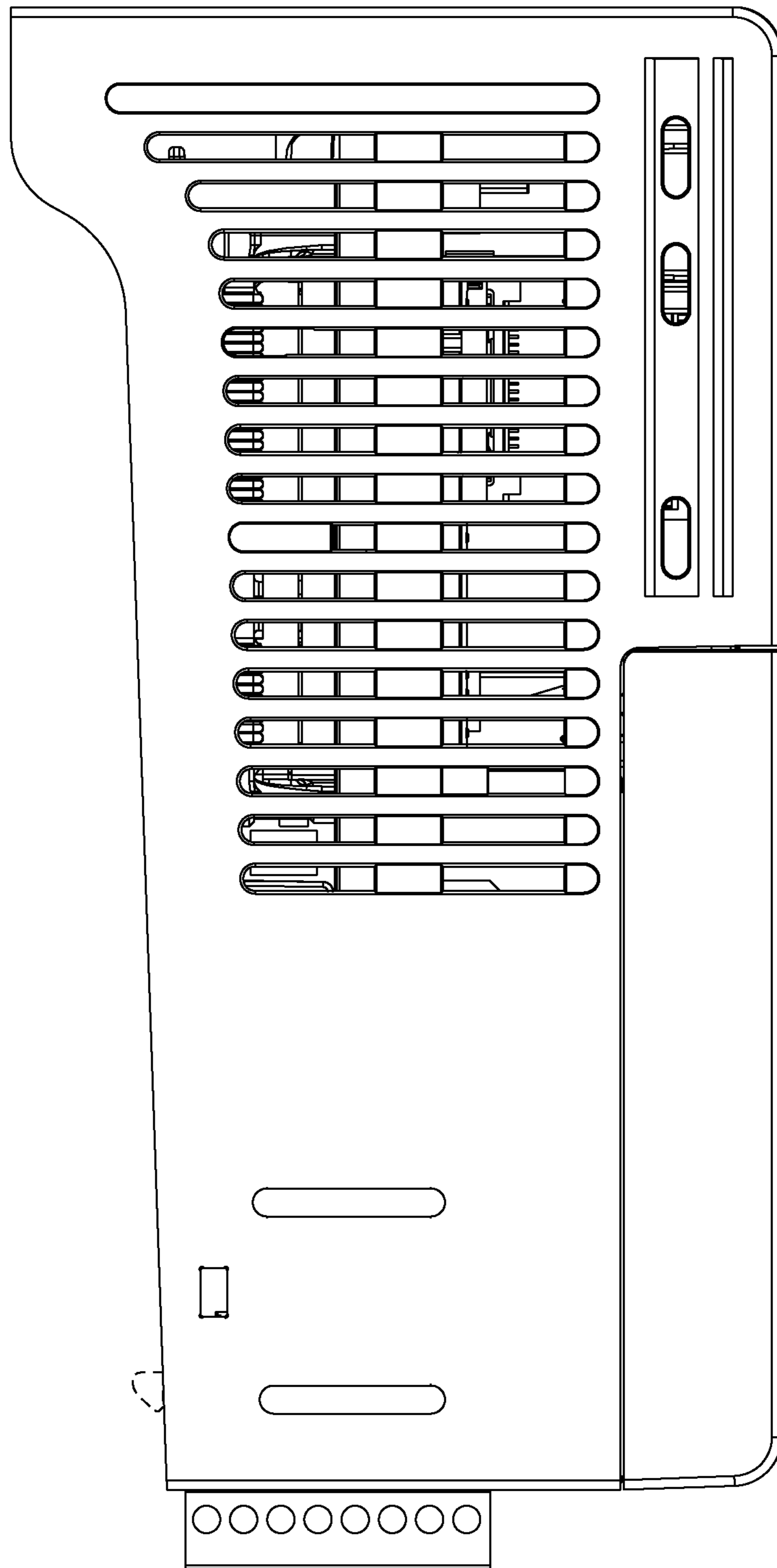

FIG. 5

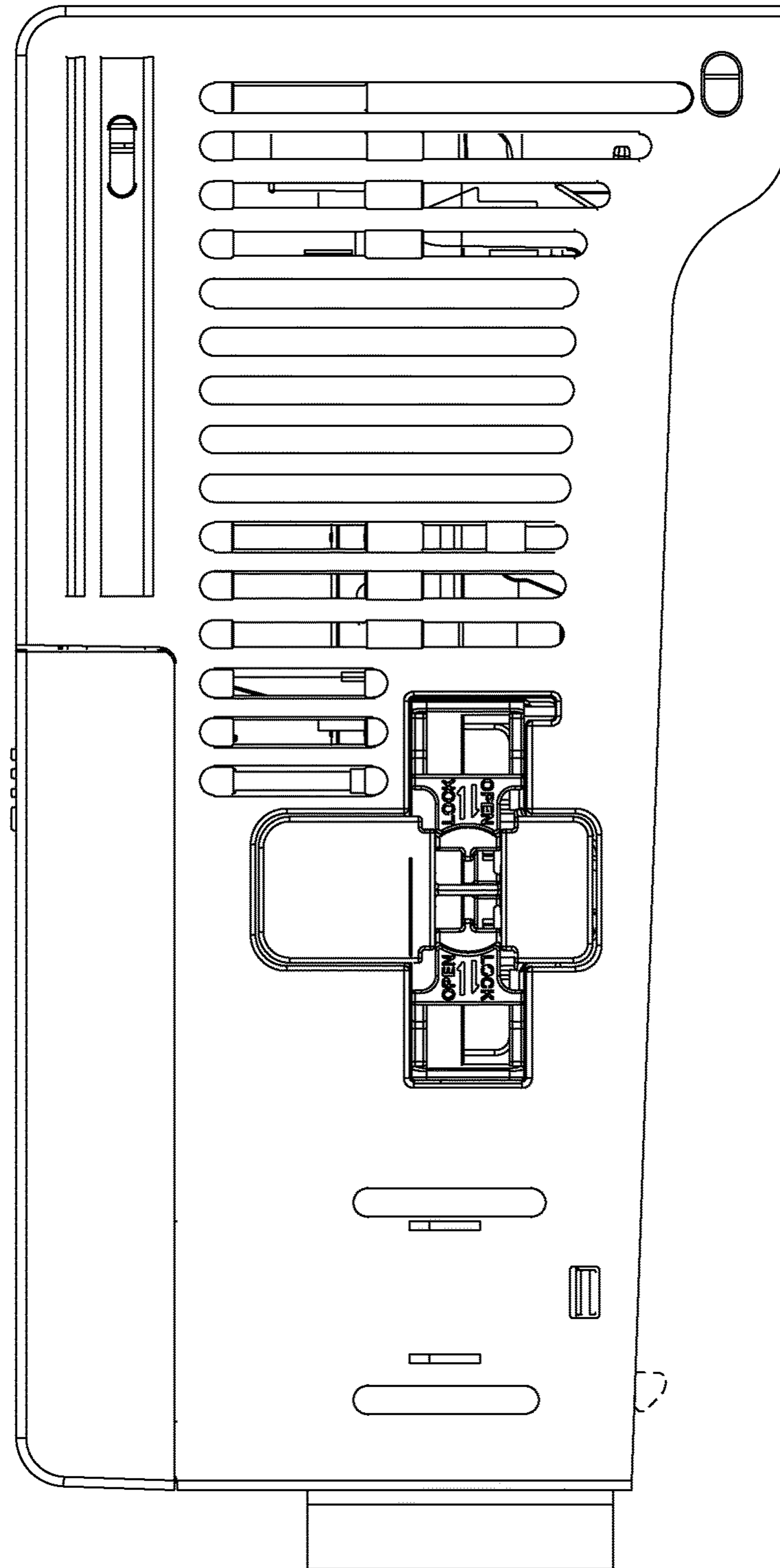

FIG. 6

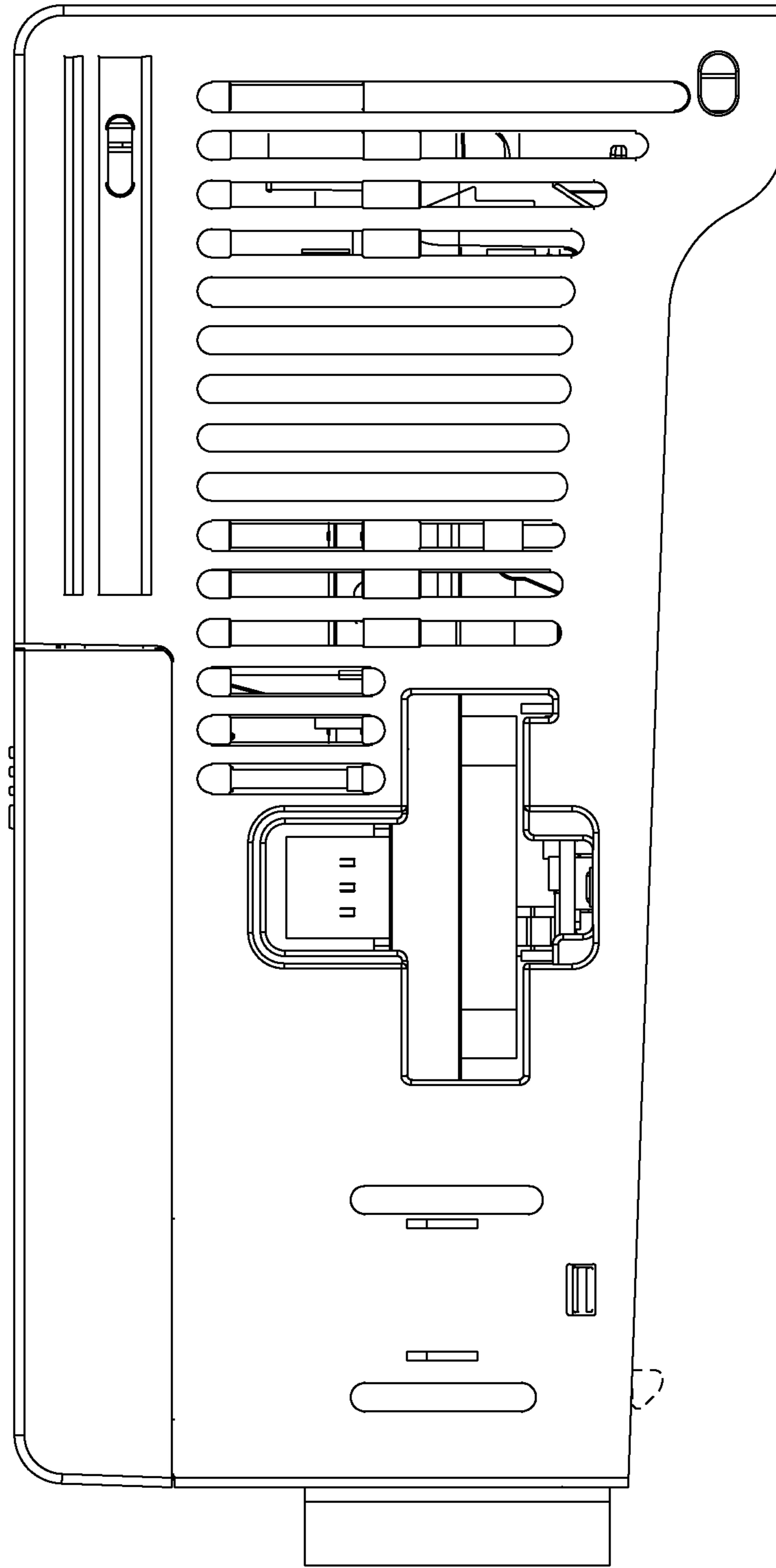

FIG. 7

FIG. 8

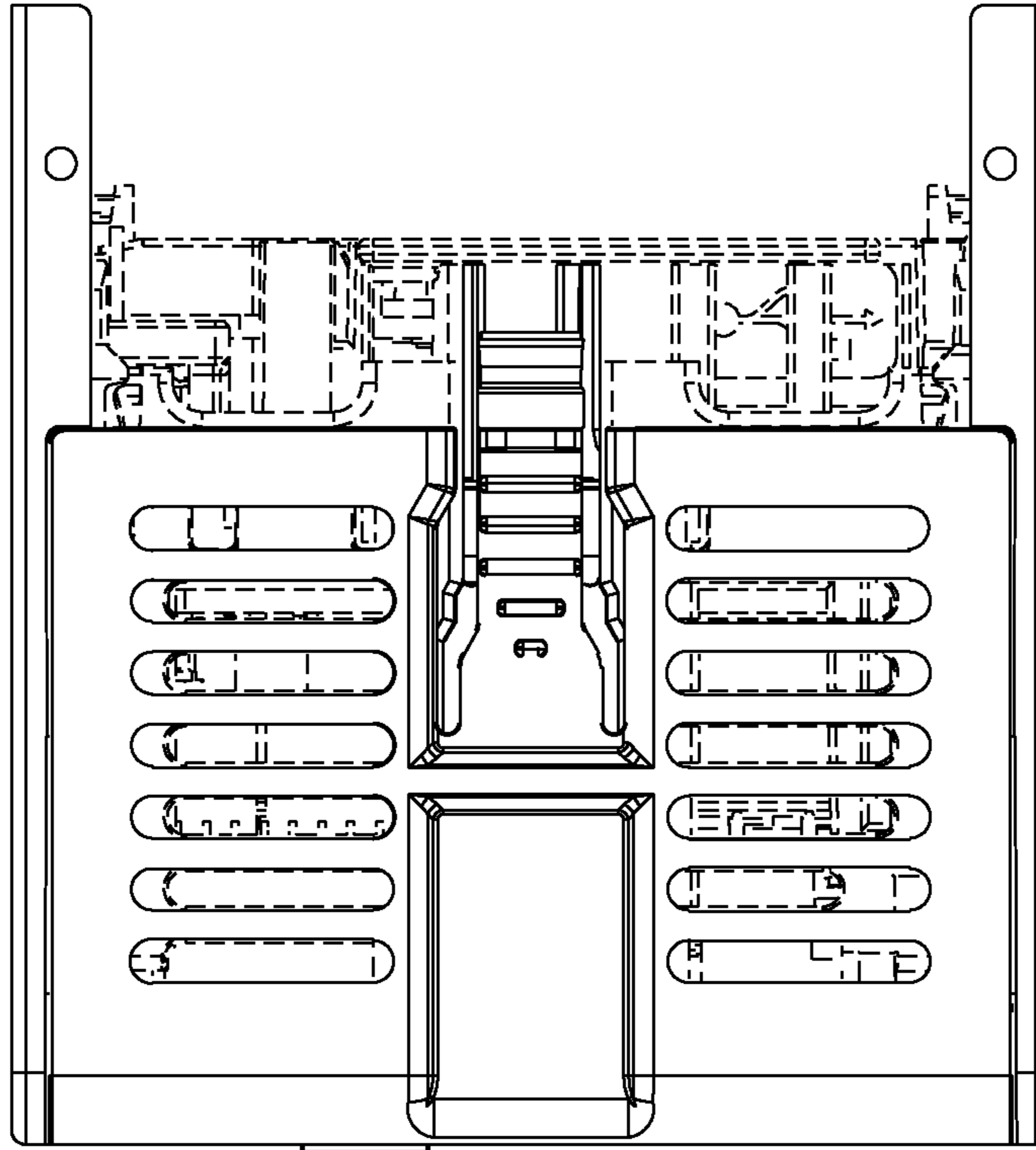
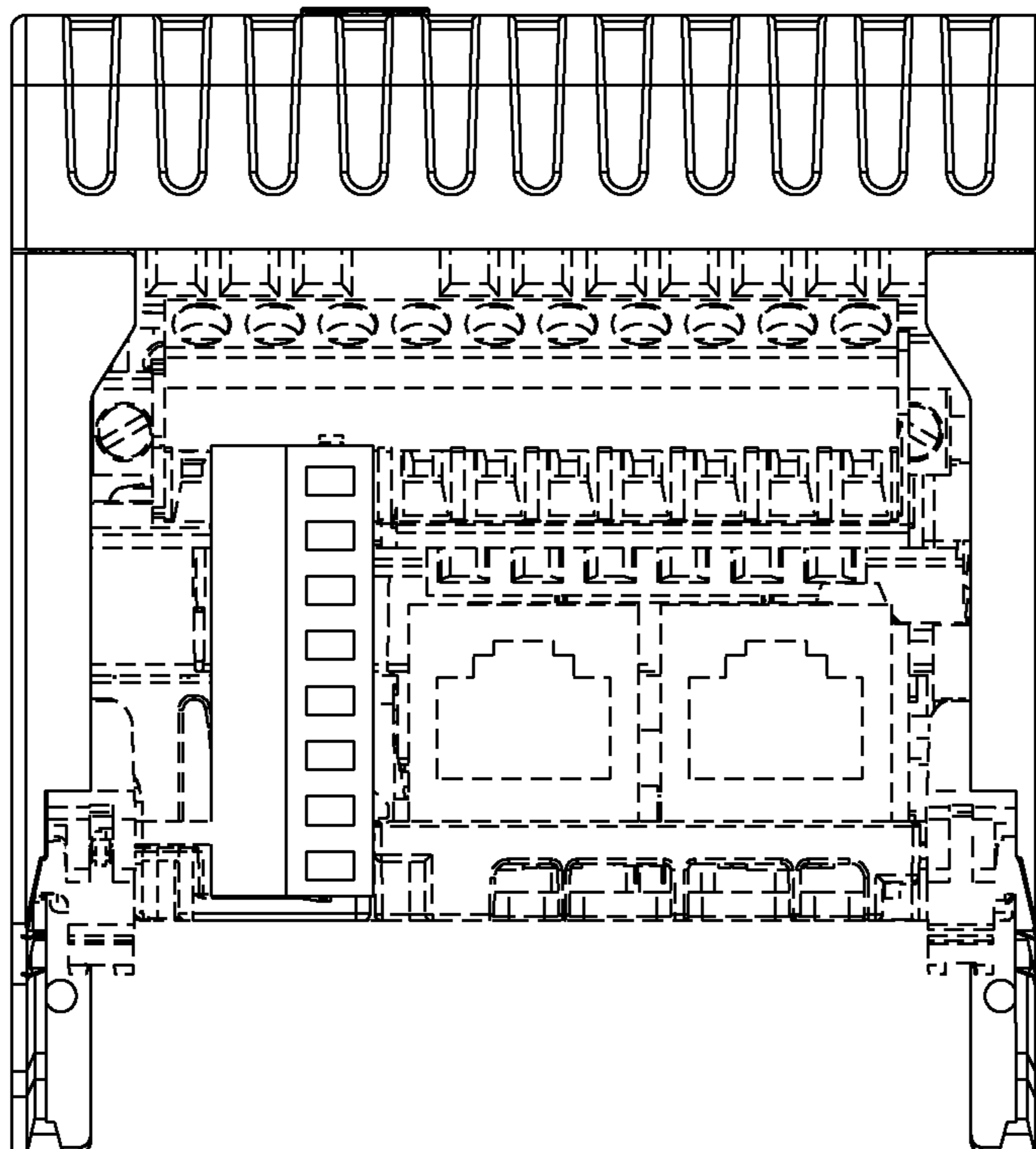

FIG. 9



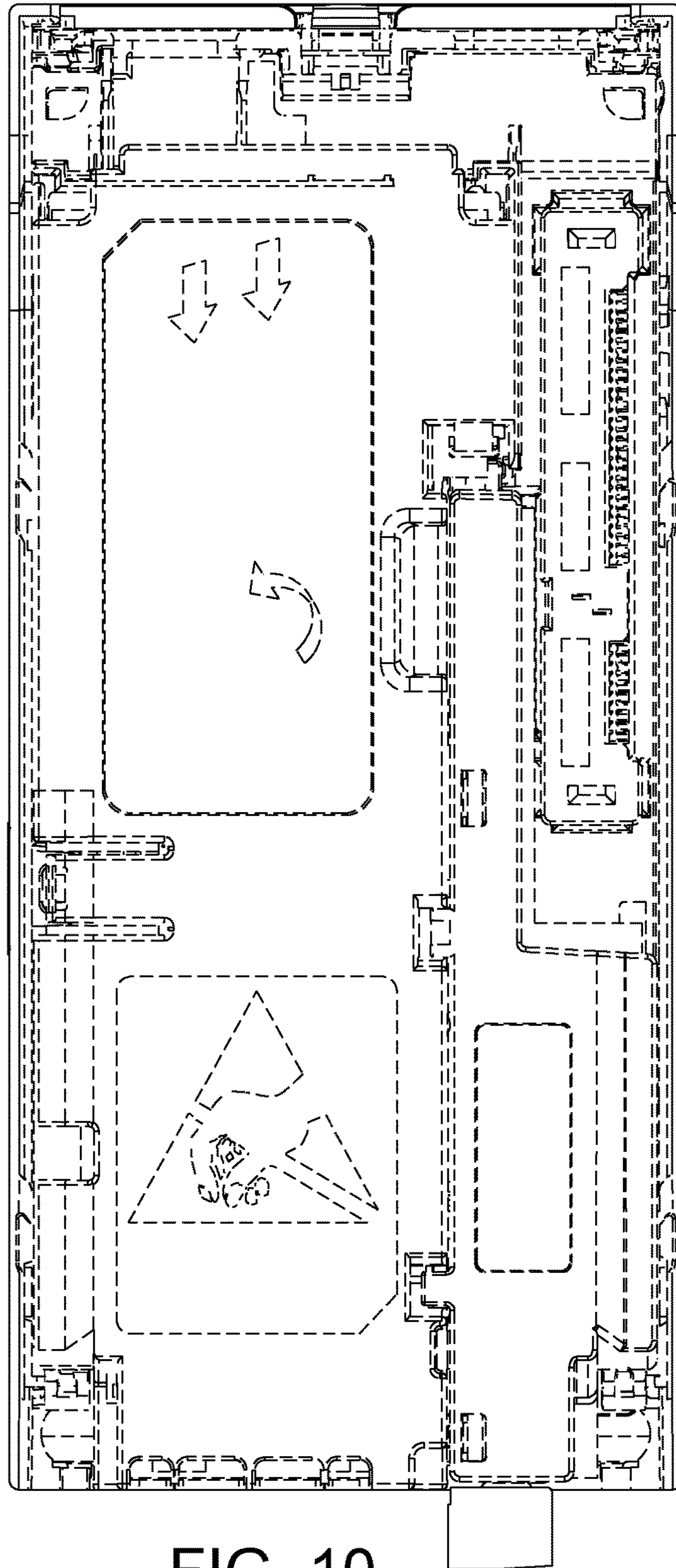

FIG. 10