

US00D839212S

(12) **United States Design Patent**
Stolze

(10) **Patent No.:** **US D839,212 S**

(45) **Date of Patent:** **** Jan. 29, 2019**

(54) **WIRE TERMINAL**

(71) Applicant: **WAGO Verwaltungsgesellschaft mbH**,
Minden (DE)

(72) Inventor: **Henry Stolze**, Bad Frankenhausen (DE)

(73) Assignee: **WAGO Verwaltungsgesellschaft mbH**,
Minden (DE)

(**) Term: **15 Years**

(21) Appl. No.: **29/575,789**

(22) Filed: **Aug. 29, 2016**

(30) **Foreign Application Priority Data**

Feb. 29, 2016 (EM) 003007061-0001

(51) **LOC (11) Cl.** **13-03**

(52) **U.S. Cl.**
USPC **D13/154**

(58) **Field of Classification Search**
USPC D13/118, 120, 123, 133, 146, 147, 154,
D13/184, 199
CPC ... H01R 4/16; H01R 4/18; H01R 4/20; H01R
43/02; H01R 43/048; H01R 9/24; H01R
9/048; H01R 13/05; H01R 13/11; H01R
13/245; H01R 13/2464; H01R 13/26;
H01R 13/432; H01R 13/506; H01R
13/52; H01R 13/533; H01R 13/627;
H01R 13/62

See application file for complete search history.

(56) **References Cited**

U.S. PATENT DOCUMENTS

3,363,224 A *	1/1968	Gluntz	H01R 13/11 439/852
D660,249 S *	5/2012	Chen	D13/154
D744,958 S *	12/2015	Chen	D13/154
D756,934 S *	5/2016	Chen	D13/118
2014/0004760 A1 *	1/2014	Kiryu	H01R 13/05 439/884

* cited by examiner

Primary Examiner — Daniel D Bui

(74) *Attorney, Agent, or Firm* — Muncy, Geissler, Olds &
Lowe, P.C.

(57) **CLAIM**

The ornamental design for a wire terminal, as shown and
described.

DESCRIPTION

FIG. 1 is a front perspective view of a wire terminal
according to the present invention.
FIG. 2 is a front elevation view thereof;
FIG. 3 is a rear elevation view thereof;
FIG. 4 is a left side elevation view thereof;
FIG. 5 is a right side elevation view thereof;
FIG. 6 is a top plan view thereof; and,
FIG. 7 is a bottom plan view thereof.
In the drawings, the broken line represents unclaimed envi-
ronment and forms no part of the claimed design and the
dash-dot line presents the boundary of the claimed design.

1 Claim, 7 Drawing Sheets

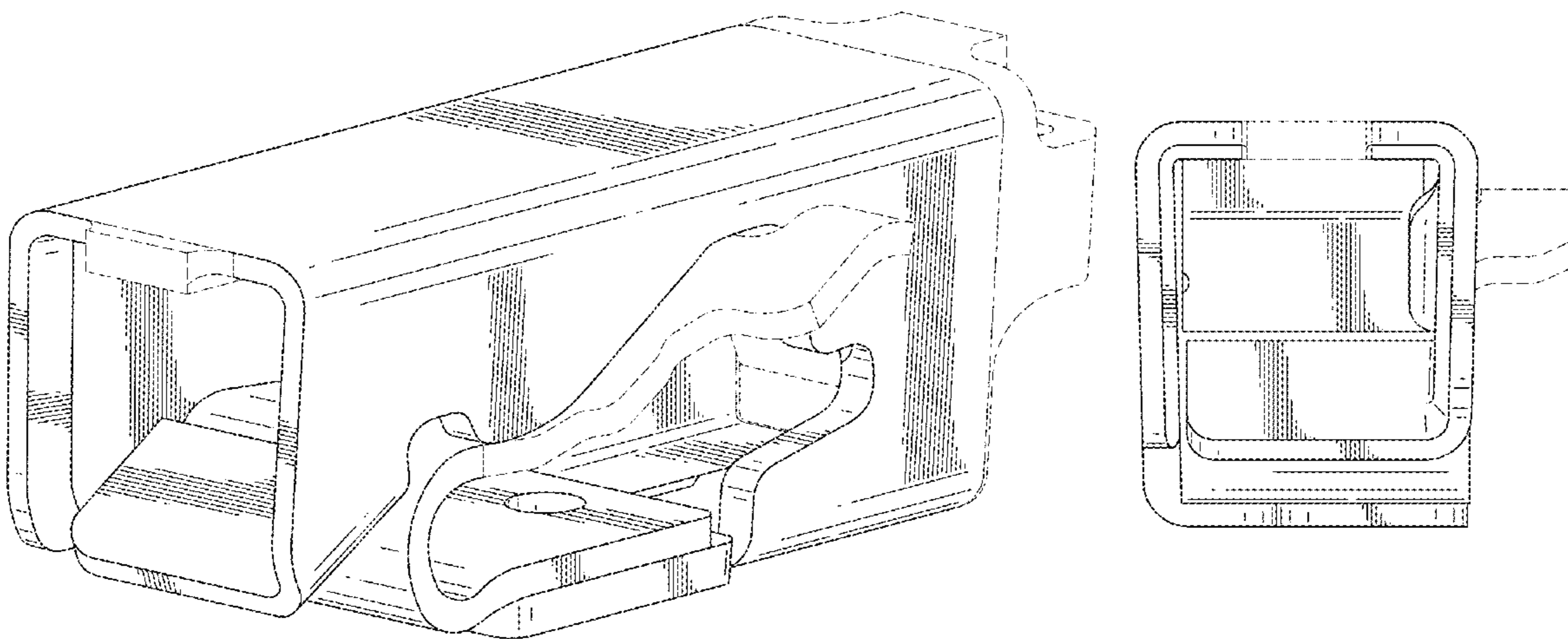

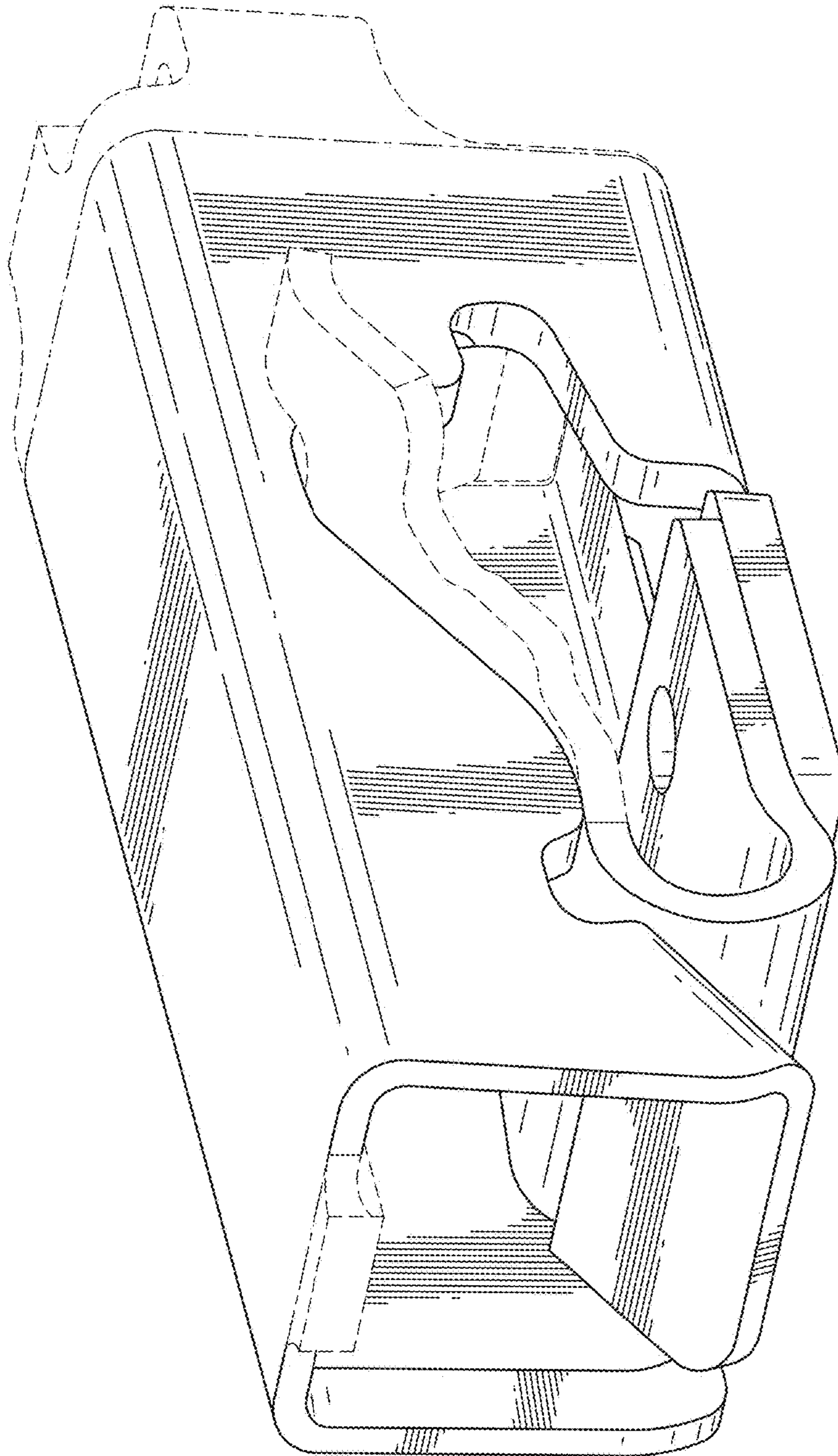

FIG. 1

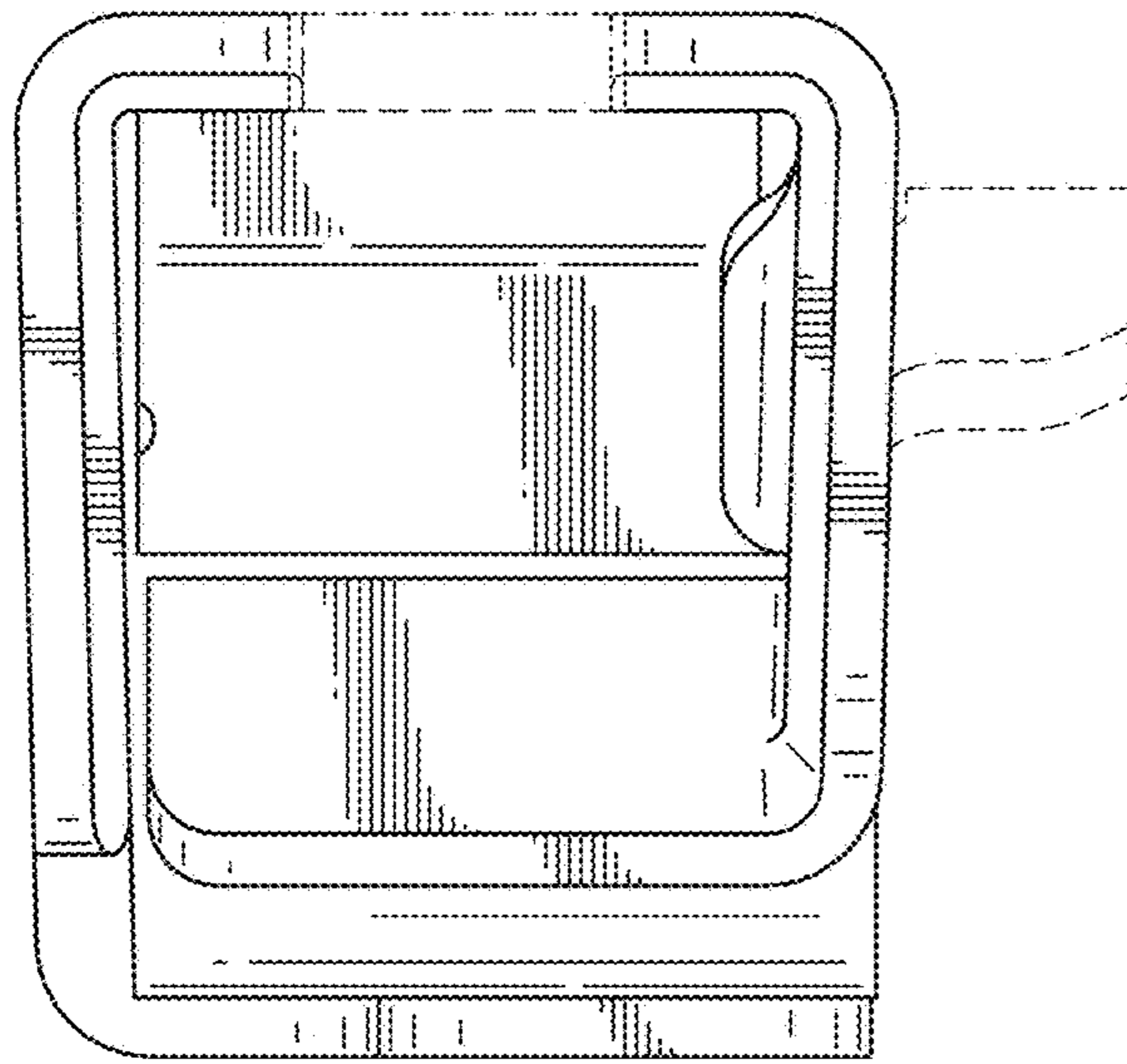

FIG.2

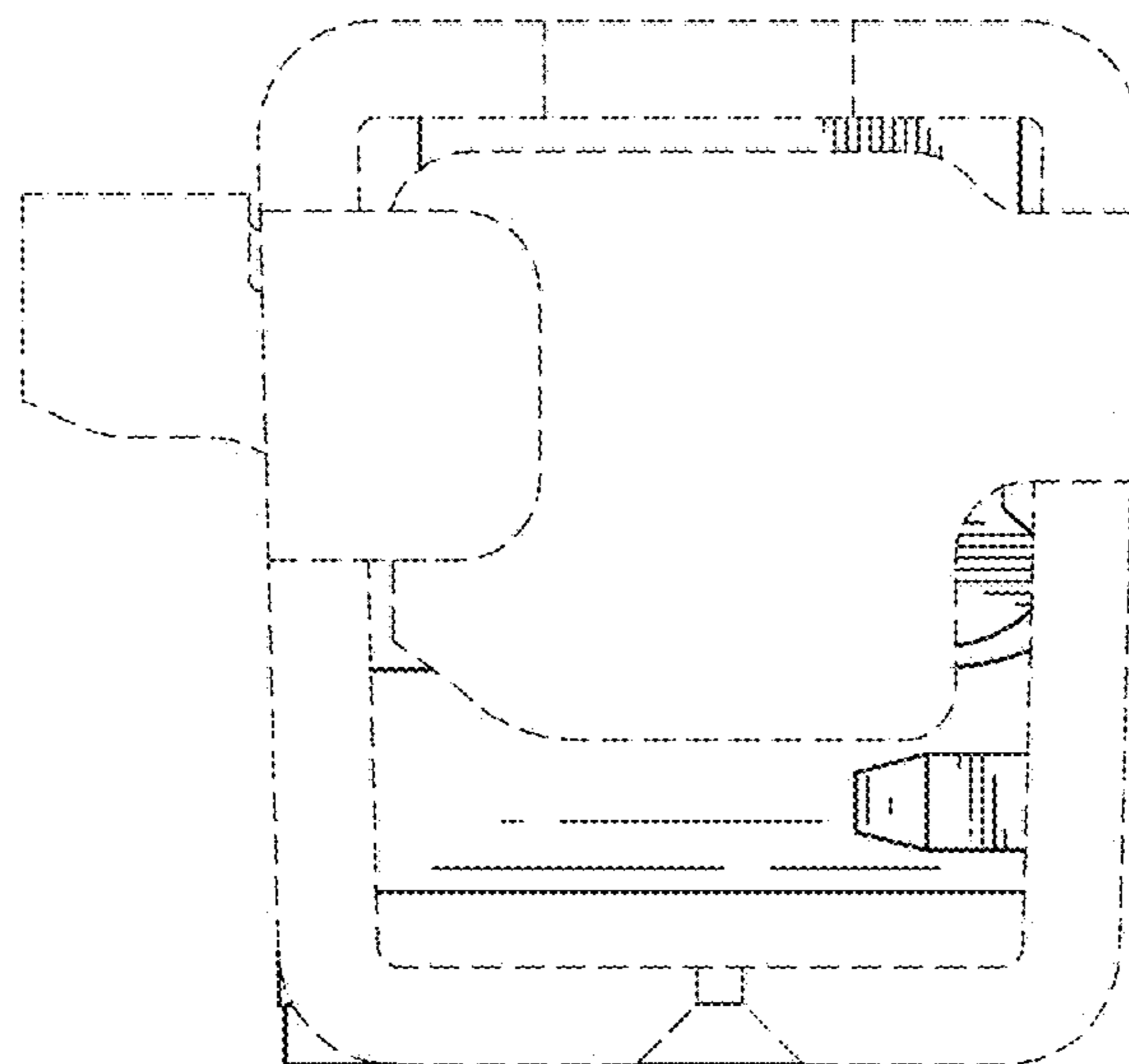

FIG.3

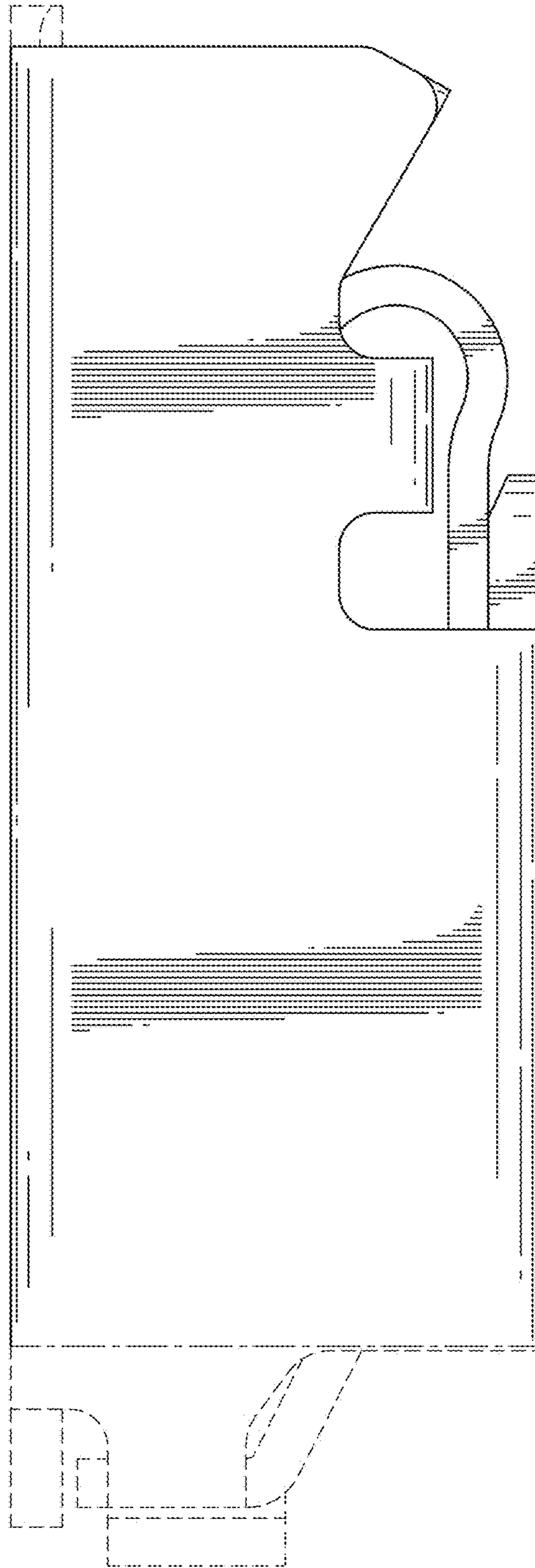

FIG.4

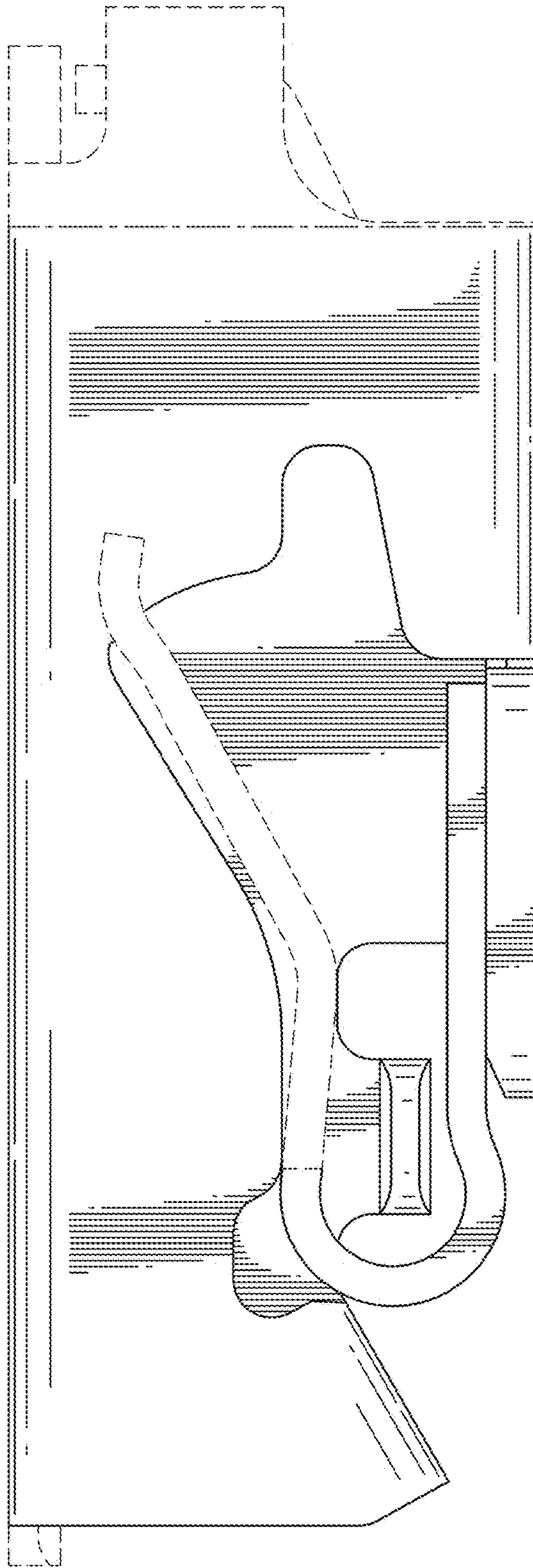

FIG. 5

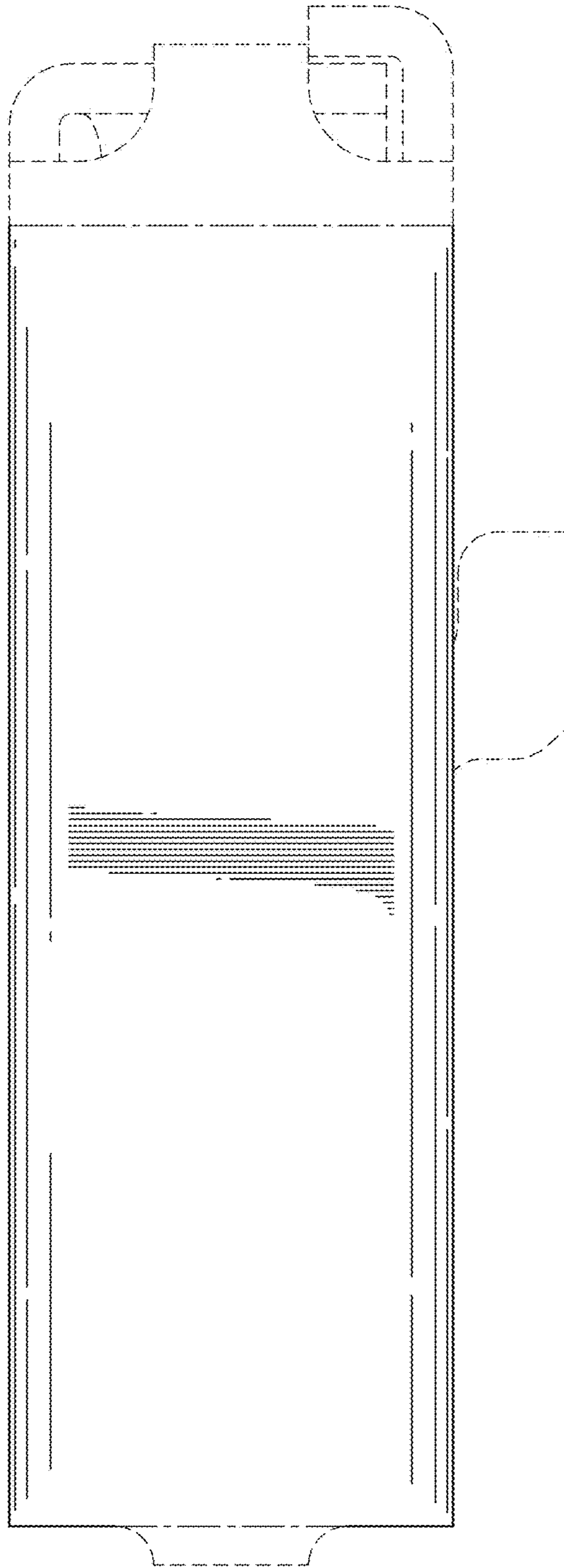

FIG.6

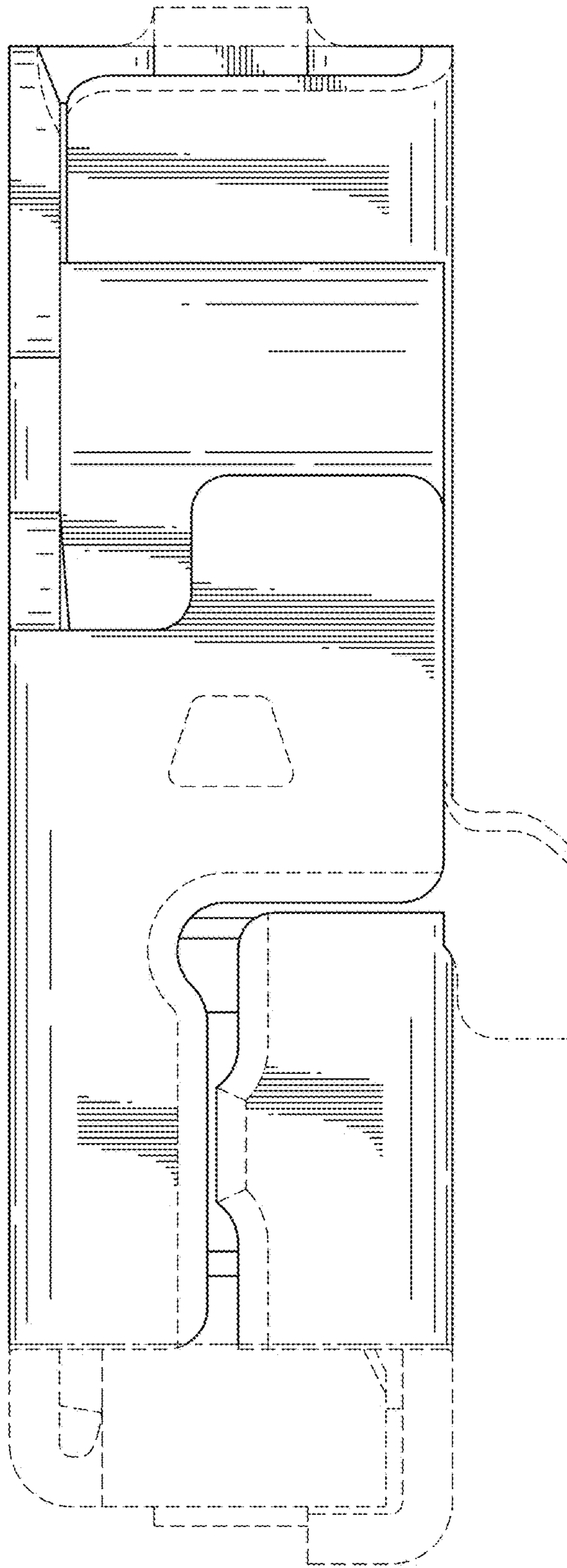

FIG.7