



US00D839183S

(12) **United States Design Patent**
Kirkpatrick

(10) **Patent No.:** **US D839,183 S**

(45) **Date of Patent:** **** Jan. 29, 2019**

(54) **BATTERY PACK CHARGER**

(71) Applicant: **BLACK & DECKER, INC.**, New Britain, CT (US)

(72) Inventor: **Jonathan Kirkpatrick**, Baldwin, MD (US)

(73) Assignee: **Black & Decker Inc.**, New Britain, CT (US)

(**) Term: **15 Years**

(21) Appl. No.: **29/581,628**

(22) Filed: **Oct. 20, 2016**

(51) **LOC (11) Cl.** **13-02**

(52) **U.S. Cl.**
USPC **D13/107**

(58) **Field of Classification Search**
USPC D13/102–106, 110, 118–119, 184
CPC Y02E 60/12; Y02E 60/122; Y02E 60/124;
Y02E 60/50; H01M 2/02; H01M 2/022;
H01M 2/0202; H01M 2/0207; H01M
2/0212; H01M 2/1061; H01M 2/1022;
H01M 2/1055; H01M 2/1066; H01M
2/105; H01M 2/204; H01M 10/4257;
H01M 10/0436; H01M 10/48

See application file for complete search history.

(56) **References Cited**

U.S. PATENT DOCUMENTS

| | | | | |
|--------------|---------|----------|-------|---------|
| D487,570 S * | 3/2004 | Ito | | D13/107 |
| D605,111 S * | 12/2009 | Schoch | | D13/107 |
| D610,085 S * | 2/2010 | Sweeney | | D13/107 |
| D621,345 S * | 8/2010 | Tinius | | D13/107 |
| D635,917 S * | 4/2011 | Okuda | | D13/107 |
| D636,723 S * | 4/2011 | Yamamoto | | D13/107 |
| D642,518 S * | 8/2011 | Kokawa | | D13/107 |

| | | | | |
|-------------------|---------|-----------|-------|-------------|
| D652,793 S * | 1/2012 | Tschopp | | D13/107 |
| D743,330 S * | 11/2015 | Zhang | | D13/107 |
| 9,728,984 B2 * | 8/2017 | Ogura | | H02J 7/0026 |
| 2009/0051313 A1 * | 2/2009 | Yoshimura | | H02J 7/0042 |
| | | | | 320/107 |
| 2010/0085008 A1 * | 4/2010 | Suzuki | | B25F 5/00 |
| | | | | 320/112 |
| 2012/0098494 A1 * | 4/2012 | Ogura | | H01M 10/46 |
| | | | | 320/112 |

* cited by examiner

Primary Examiner — Jennifer Rivard

Assistant Examiner — Alison M Ofstun

(74) *Attorney, Agent, or Firm* — Michael Aronoff

(57) **CLAIM**

The ornamental design for a battery pack charger, as shown and described.

DESCRIPTION

FIG. 1 is a top, front, right perspective view of a battery pack charger showing my new design.

FIG. 2 is a front elevation view of the battery pack charger of FIG. 1.

FIG. 3 is a right side elevation view of the battery charger pack of FIG. 1.

FIG. 4 is a rear elevation view of the battery pack charger of FIG. 1.

FIG. 5 is a left side elevation view of the battery pack charger of FIG. 1.

FIG. 6 is a top plan view of the battery pack charger of FIG. 1; and,

FIG. 7 is a bottom plan view of the battery pack charger of FIG. 1.

The broken lines present in the drawings are included for the purpose of illustrating portions of the article that form no part of the claimed design.

1 Claim, 7 Drawing Sheets

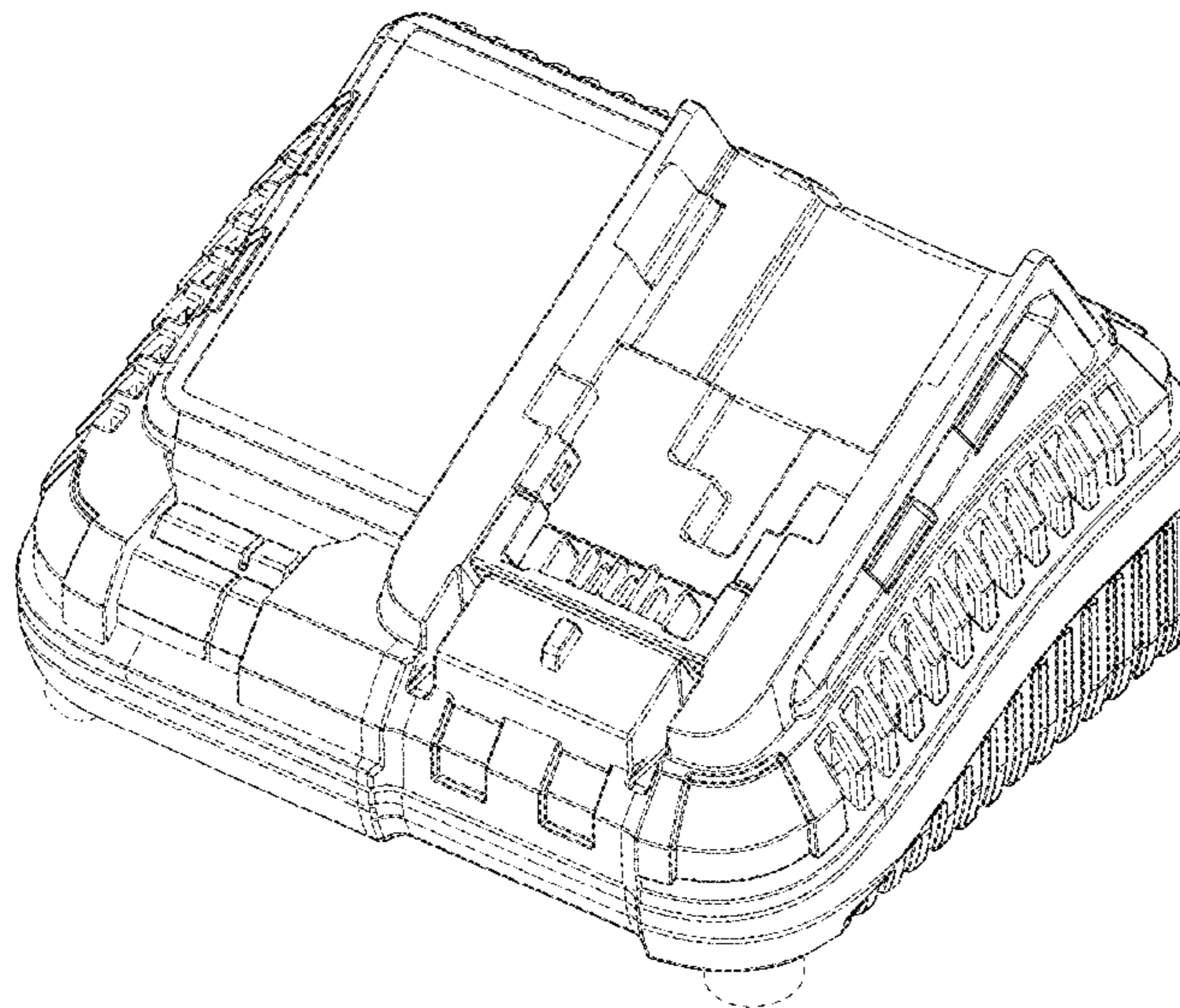

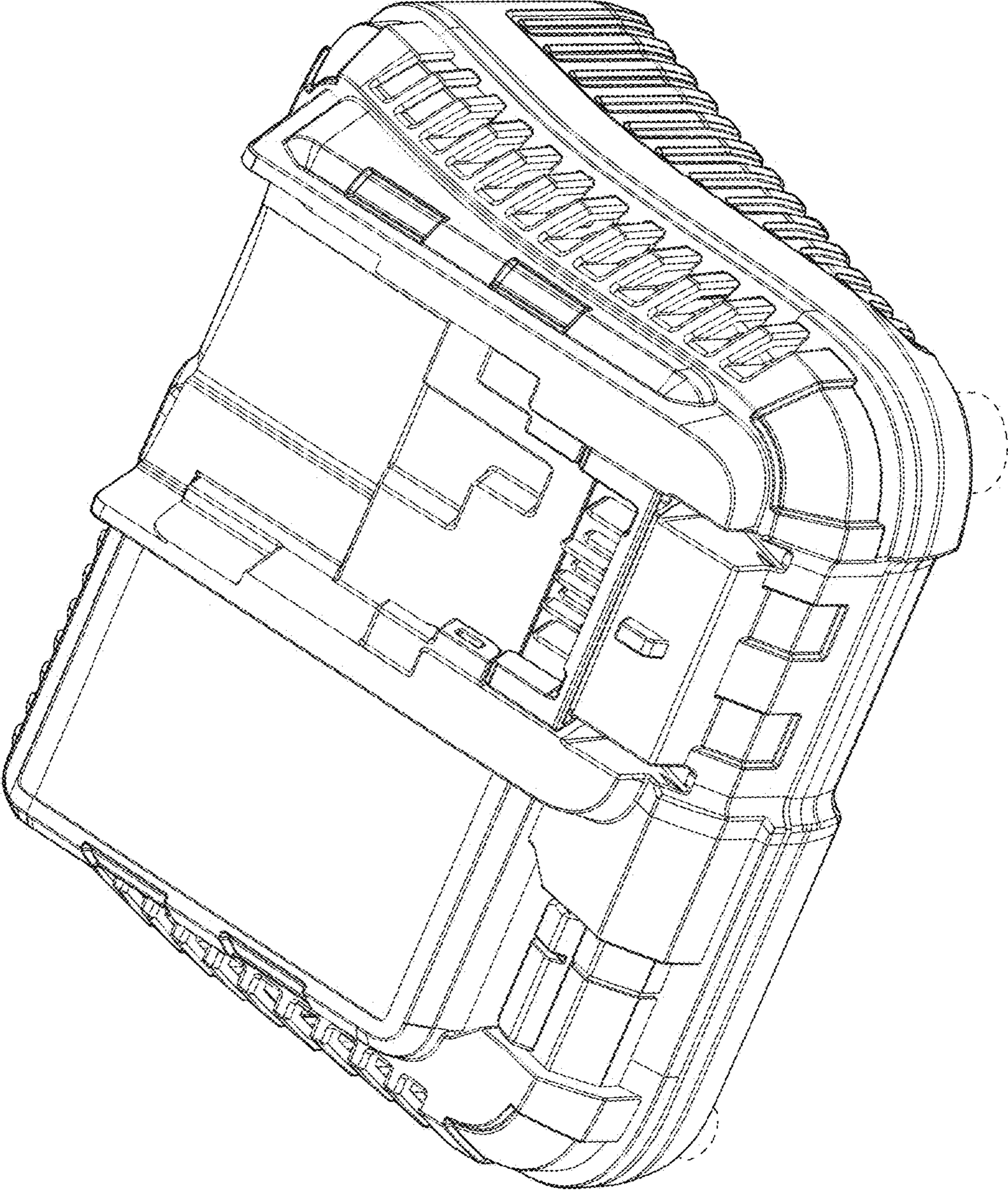

Figure 1

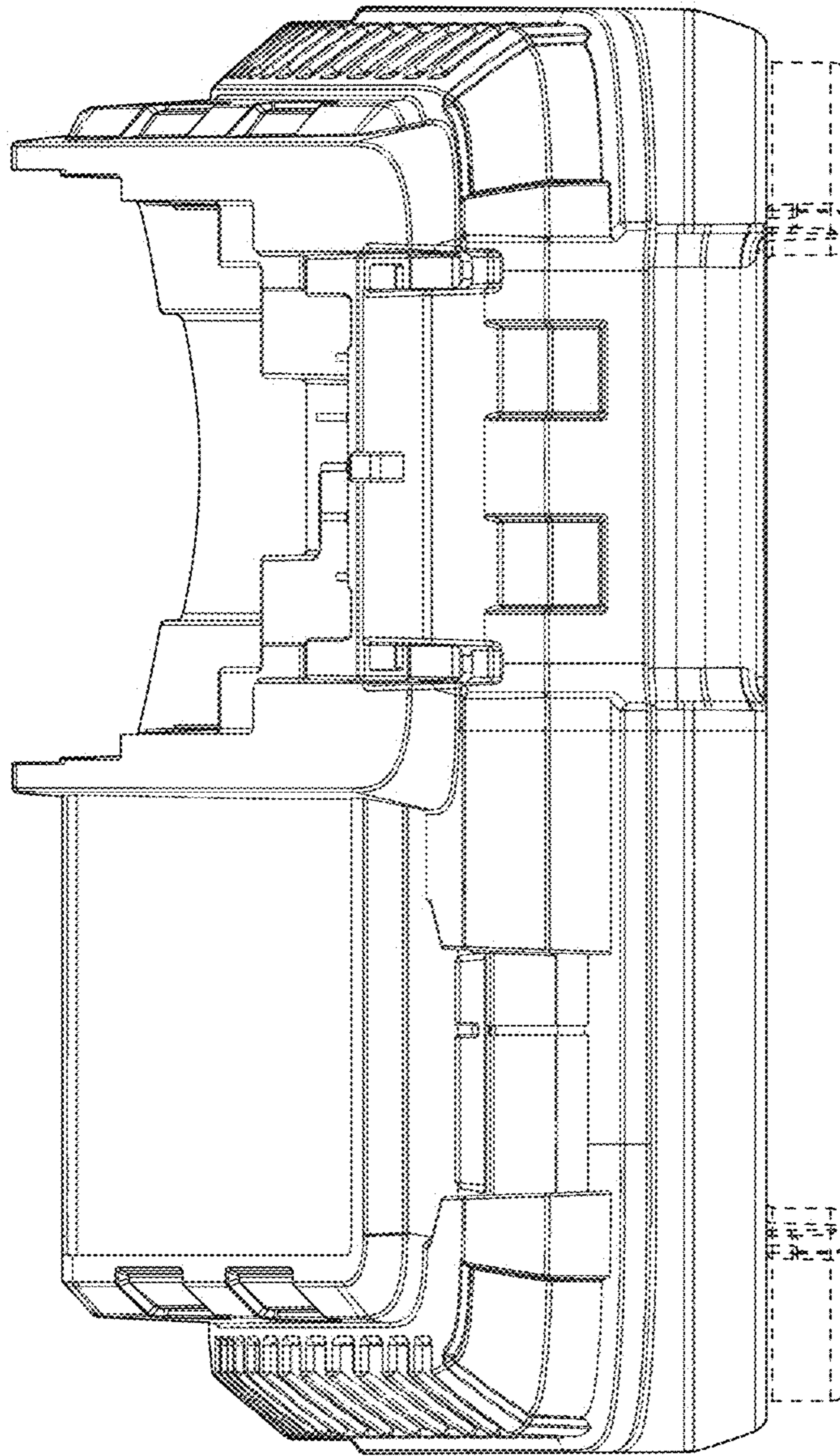

Figure 2

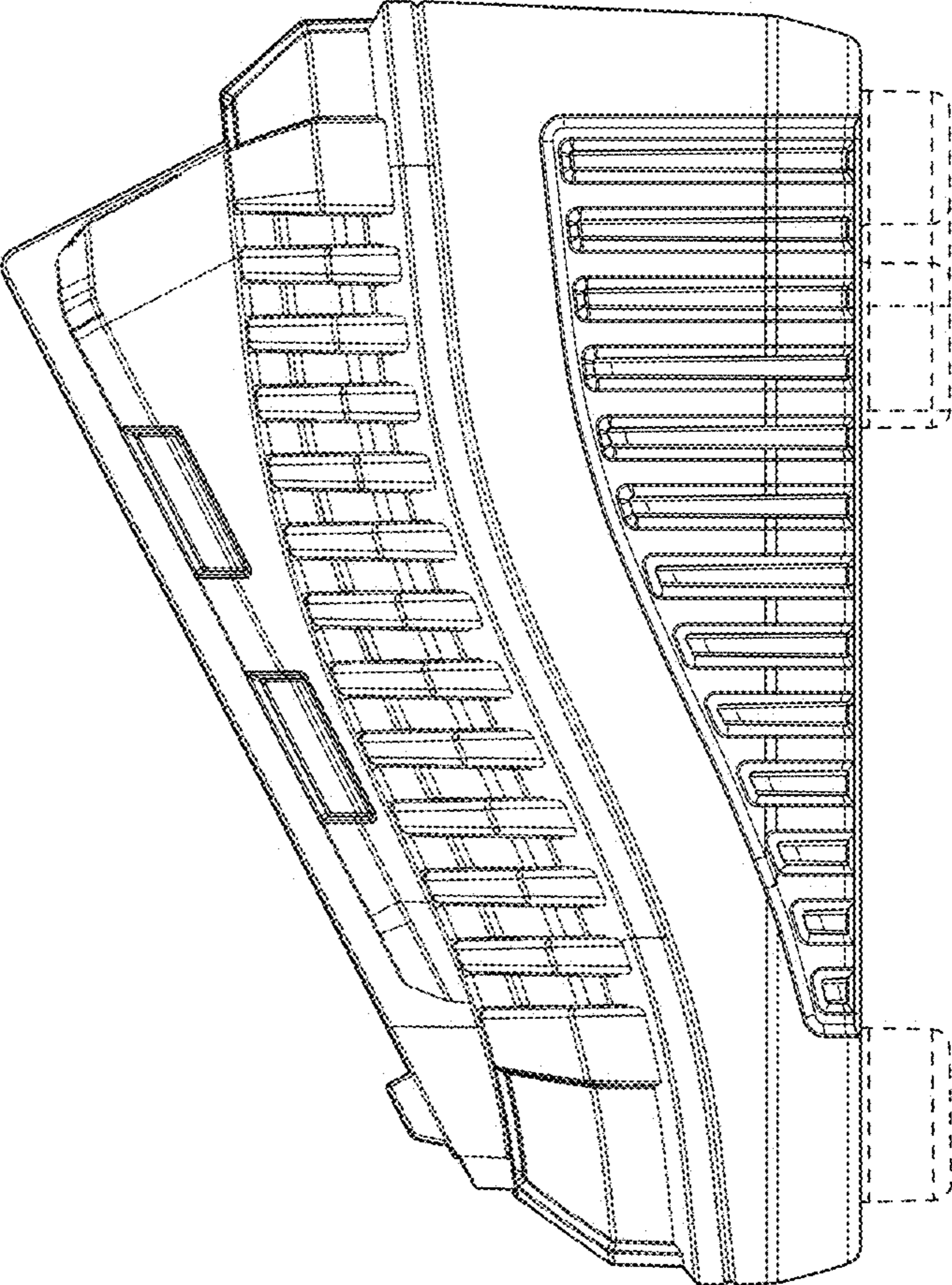

Figure 3

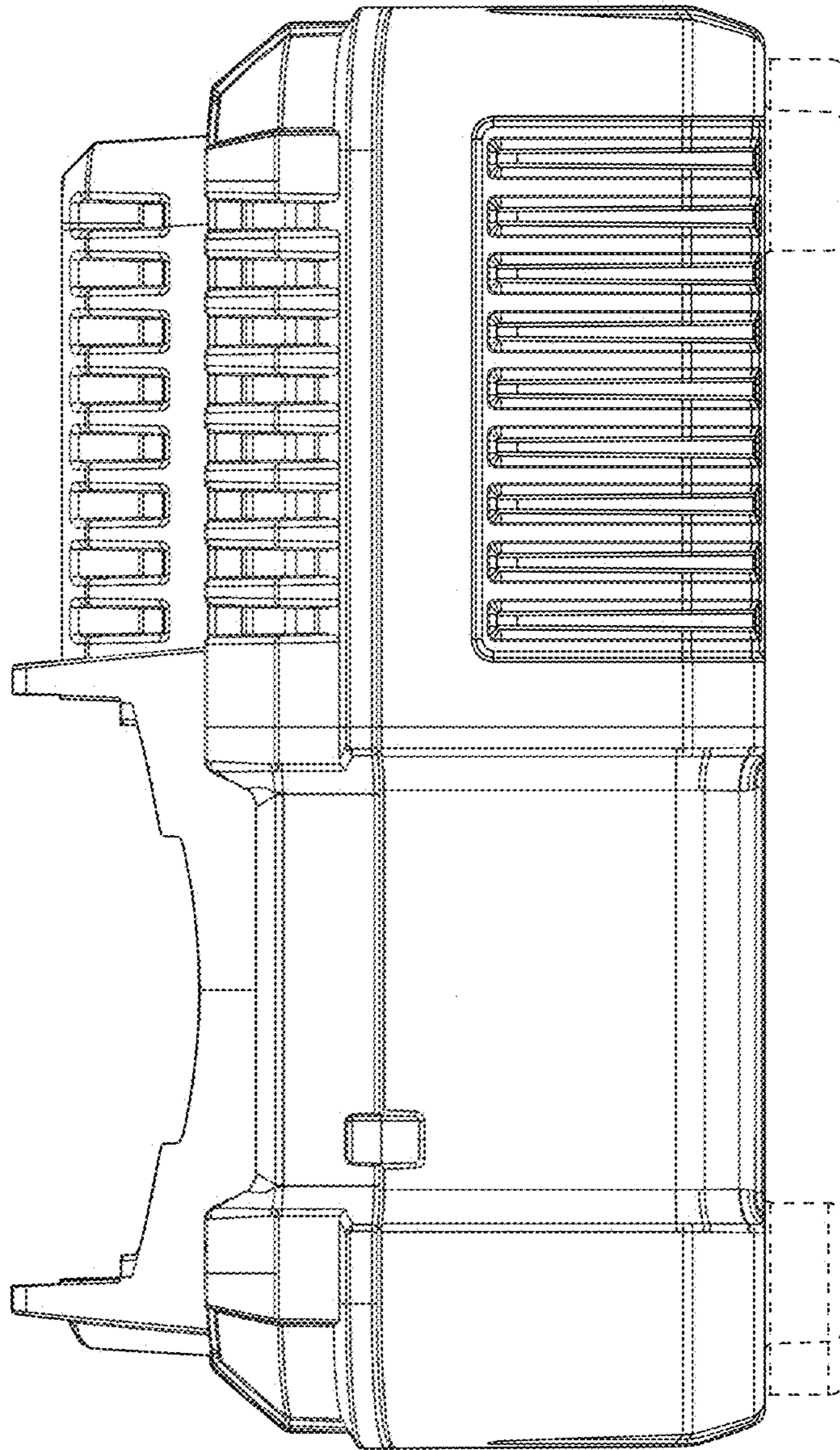

Figure 4

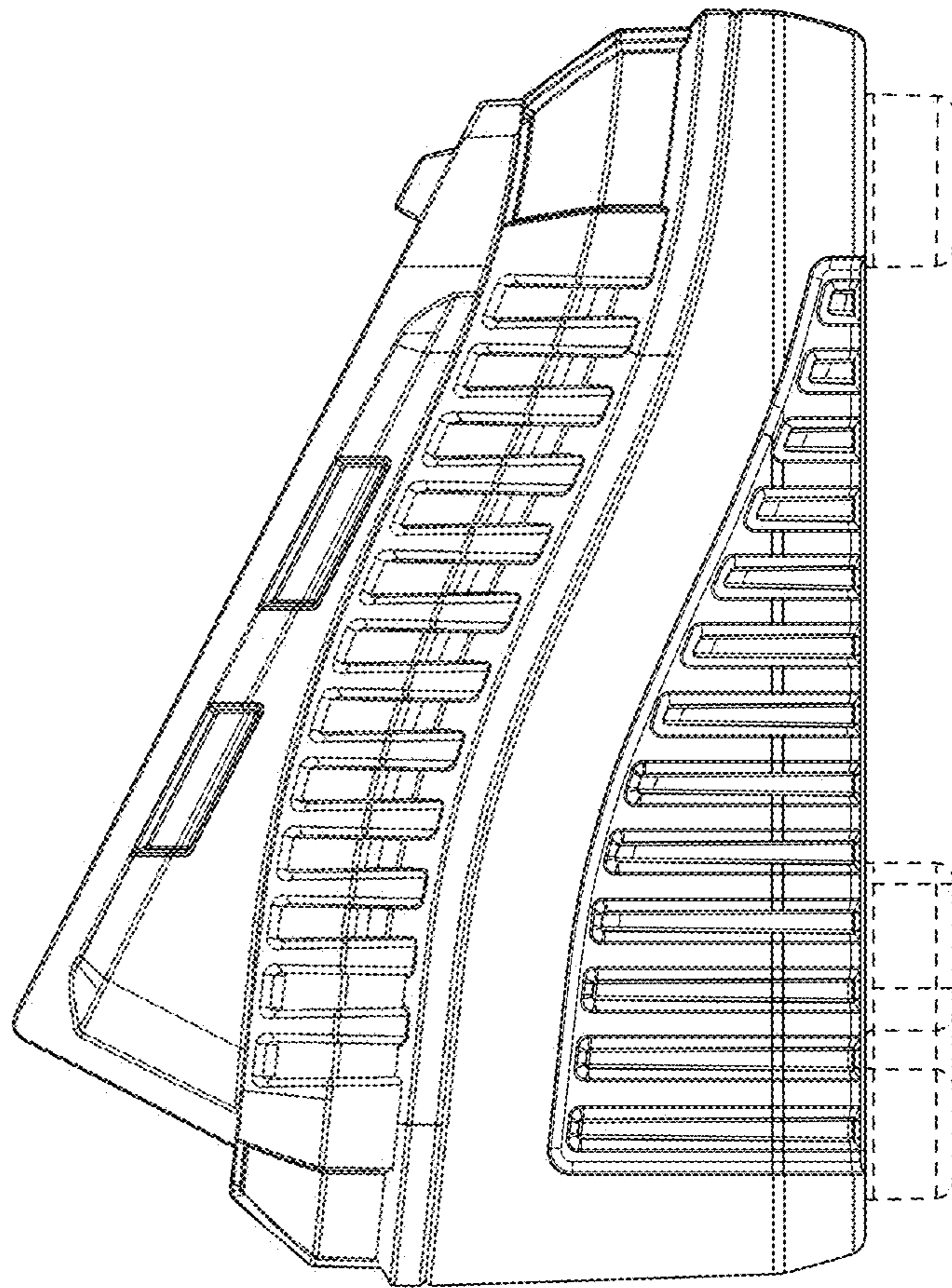

Figure 5

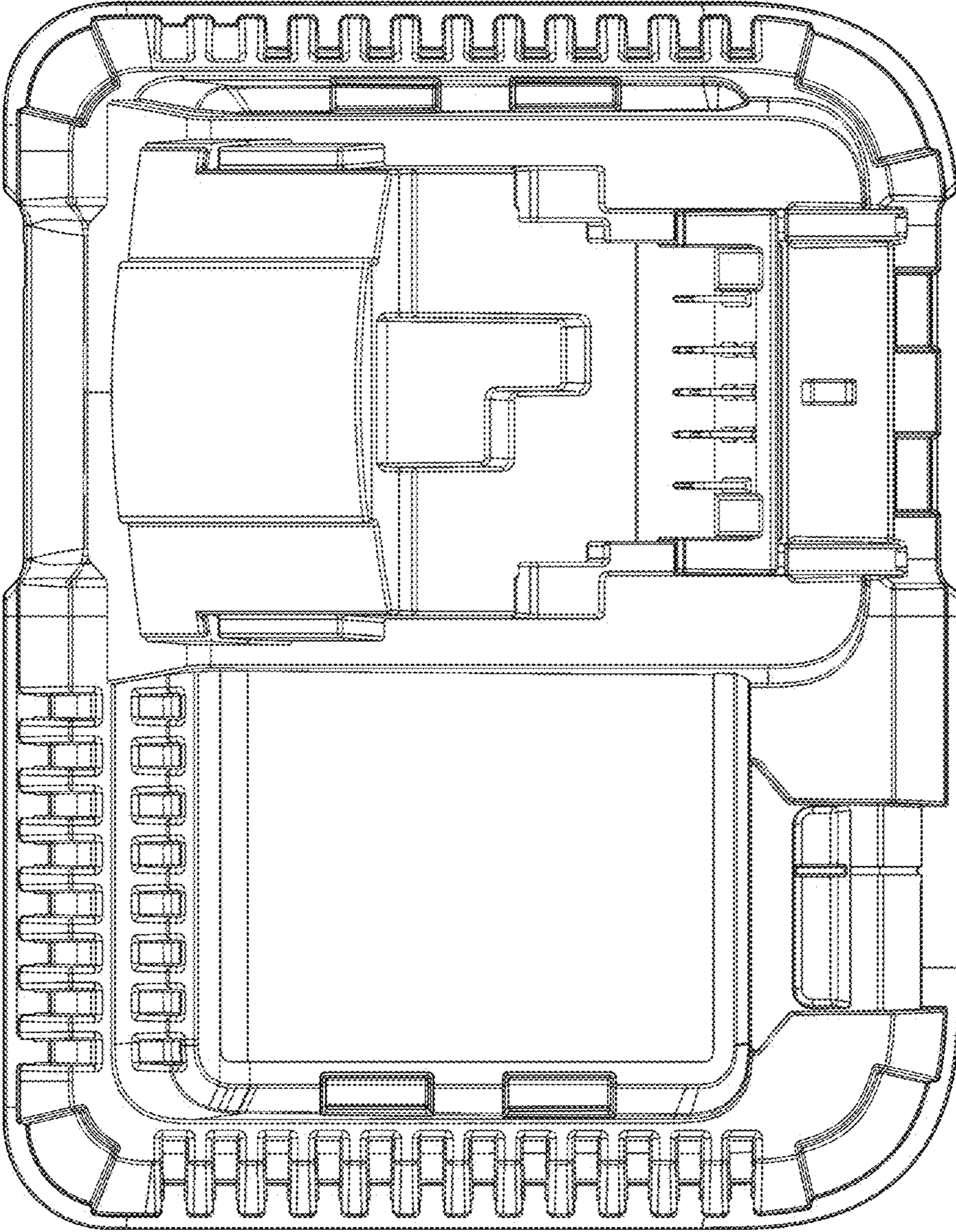

Figure 6

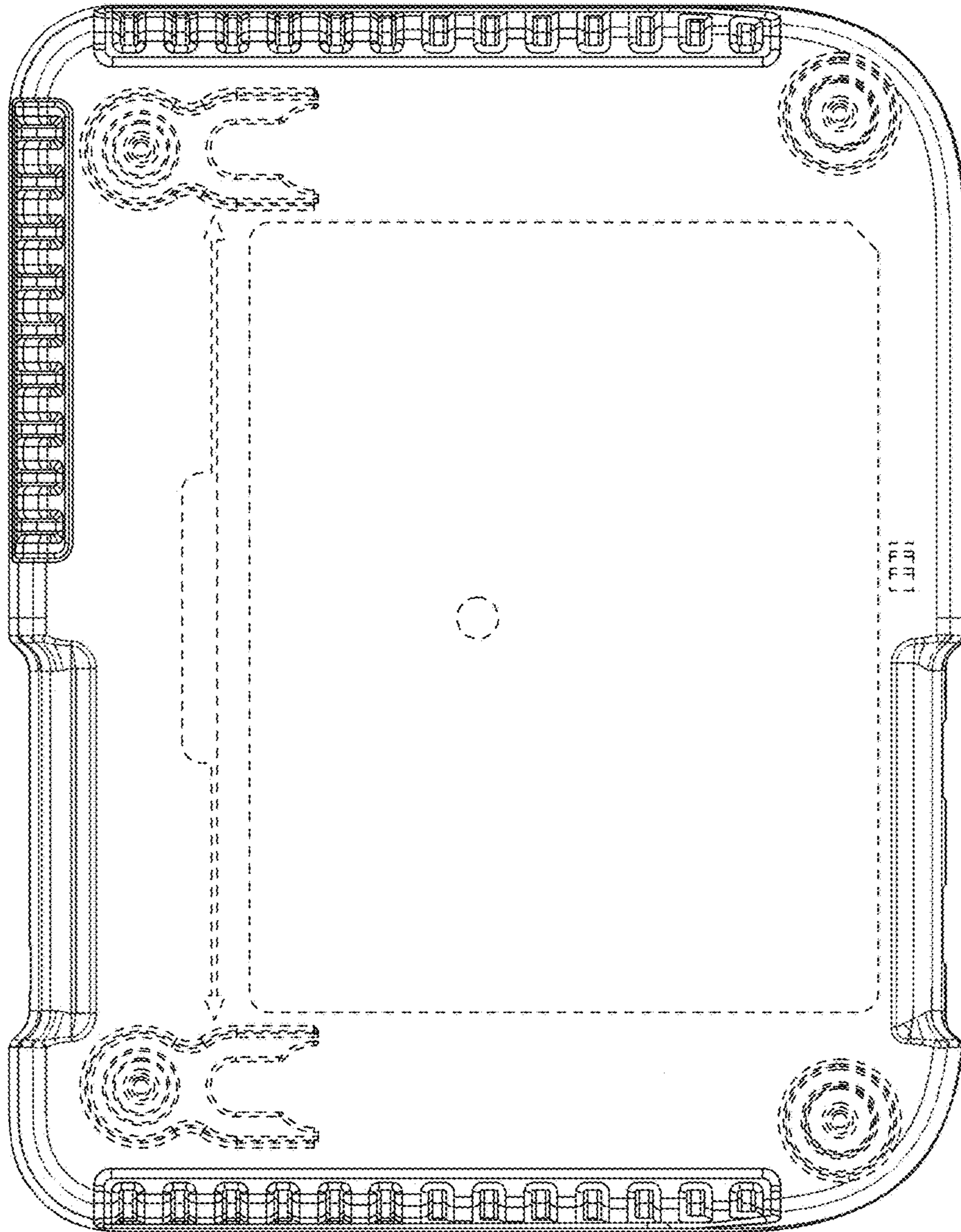

Figure 7