



US00D838999S

(12) **United States Design Patent** (10) **Patent No.:** **US D838,999 S**  
**Gandhi et al.** (45) **Date of Patent:** **\*\* \*Jan. 29, 2019**

(54) **STERILE WRAP**

WO WO 2009143551 12/2009

(71) Applicant: **Medline Industries, Inc.**, Mundelein, IL (US)

OTHER PUBLICATIONS

Examination Report for New Zealand Application No. 420781, dated Oct. 30, 2015.

(72) Inventors: **Dixit Gandhi**, Chicago, IL (US);  
**Robert A. Lockwood**, Livertyville, IL (US); **Francis A. Czajka, Jr.**, Libertyville, IL (US)

(Continued)

*Primary Examiner* — Karen S Acker  
*Assistant Examiner* — Wendy L Arminio

(73) Assignee: **MEDLINE INDUSTRIES, INC.**, Mundelein, IL (US)

(74) *Attorney, Agent, or Firm* — McAndrews, Held & Malloy, Ltd.

(\*) Notice: This patent is subject to a terminal disclaimer.

(57) **CLAIM**

The ornamental design for a sterile wrap, as shown and described.

(\*\*) Term: **14 Years**

**DESCRIPTION**

(21) Appl. No.: **29/523,443**

The application file contains at least one drawing executed in color. Copies of this patent application with color drawing (s) will be provided by the Office upon request and payment of the necessary fee.

(22) Filed: **Apr. 9, 2015**

FIG. 1 is a bottom right front perspective view of a first embodiment of a sterile wrap showing our new design;

(51) **LOC (11) Cl.** ..... **05-05**

FIG. 2 is a front elevation view thereof; the rear elevation view being a mirror image thereof;

(52) **U.S. Cl.**

USPC ..... **D5/59; D5/60**

FIG. 3 is a right-side elevation view thereof; the left-side elevation view being a mirror image thereof;

(58) **Field of Classification Search**

USPC .... D5/1, 6-8, 11-14, 16, 17, 19, 20, 23-26, D5/28, 30, 32, 35-39, 43, 46-48, 50, 51,

FIG. 4 is a top plan view thereof;

FIG. 5 is a bottom plan view thereof;

FIG. 6 is an enlarged detail view of area 6 circumscribed within FIG. 1;

(Continued)

FIG. 7 is an enlarged detail view of area 7 circumscribed within FIG. 4;

(56) **References Cited**

U.S. PATENT DOCUMENTS

RE20,260 E \* 2/1937 Weller ..... A47L 13/19

15/208

3,716,961 A \* 2/1973 Cope ..... A61F 15/001

422/294

FIG. 8 is an enlarged detail view of area 8 circumscribed within FIG. 4;

FIG. 9 is a cross-section view taken along the line 9-9 in FIG. 8;

FIG. 10 is a bottom right front perspective view of a second embodiment of a sterile wrap showing our new design:

FIG. 11 is a front elevation view thereof; the rear elevation view being a mirror image thereof;

FIG. 12 is a right-side elevation view thereof; the left-side elevation view being a mirror image thereof;

FIG. 13 is a top plan view thereof;

(Continued)

FOREIGN PATENT DOCUMENTS

WO WO 2008/083426 7/2008

(Continued)

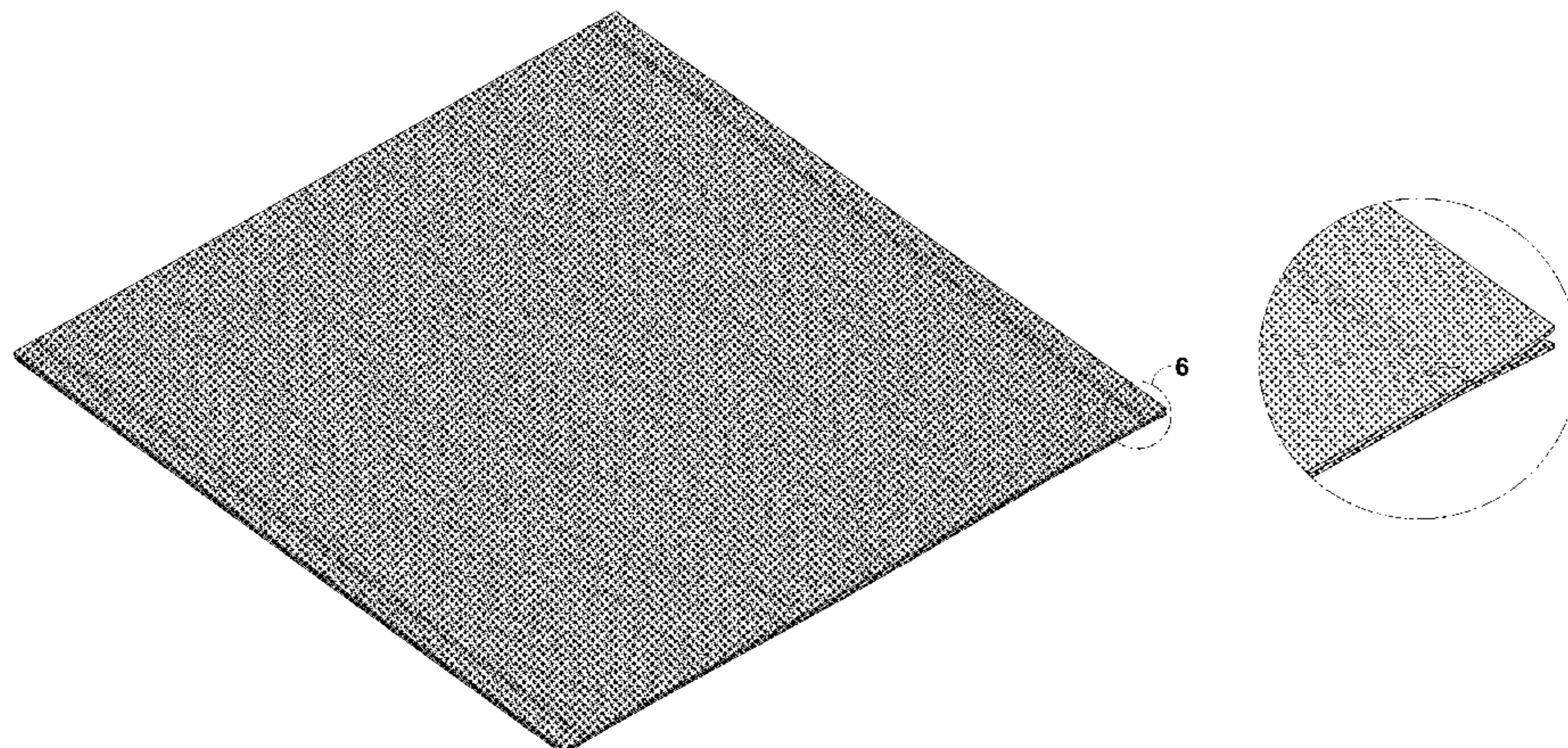

FIG. 14 is a bottom plan view thereof;  
FIG. 15 is an enlarged detail view of area 15 circumscribed within FIG. 10;  
FIG. 16 is an enlarged detail view of area 16 circumscribed within FIG. 13;  
FIG. 17 is an enlarged detail view of area 17 circumscribed within FIG. 13;  
FIG. 18 is a cross-section view taken along the line 18-18 in FIG. 17;  
FIG. 19 is a bottom right front perspective view of a third embodiment of a sterile wrap showing our new design;  
FIG. 20 is a front elevation view thereof; the rear elevation view being a mirror image thereof;  
FIG. 21 is a right-side elevation view thereof; the left-side elevation view being a mirror image thereof;  
FIG. 22 is a top plan view thereof;  
FIG. 23 is a bottom plan view thereof;  
FIG. 24 is an enlarged detail view of area 24 circumscribed within FIG. 19;  
FIG. 25 is an enlarged detail view of area 25 circumscribed within FIG. 22;  
FIG. 26 is an enlarged detail view of area 26 circumscribed within FIG. 22;  
FIG. 27 is a cross-section view taken along the line 27-27 in FIG. 26;  
FIG. 28 is a bottom right front perspective view of a fourth embodiment of a sterile wrap showing our new design;  
FIG. 29 is a front elevation view thereof; the rear elevation view being a mirror image thereof;  
FIG. 30 is a right-side elevation view thereof; the left-side elevation view being a mirror image thereof;  
FIG. 31 is a top plan view thereof;  
FIG. 32 is a bottom plan view thereof;  
FIG. 33 is an enlarged detail view of area 33 circumscribed within FIG. 28;  
FIG. 34 is an enlarged detail view of area 34 circumscribed within FIG. 31;  
FIG. 35 is an enlarged detail view of area 35 circumscribed within FIG. 31;  
FIG. 36 is a cross-section view taken along the line 36-36 in FIG. 35;  
FIG. 37 is a bottom right front perspective view of a fifth embodiment of a sterile wrap showing our new design;  
FIG. 38 is a front elevation view thereof; the rear elevation view being a mirror image thereof;  
FIG. 39 is a right-side elevation view thereof; the left-side elevation view being a mirror image thereof;  
FIG. 40 is a top plan view thereof;  
FIG. 41 is a bottom plan view thereof;  
FIG. 42 is an enlarged detail view of area 42 circumscribed within FIG. 37;  
FIG. 43 is an enlarged detail view of area 43 circumscribed within FIG. 40;  
FIG. 44 is an enlarged detail view of area 44 circumscribed within FIG. 40;  
FIG. 45 is a cross-section view taken along the line 45-45 in FIG. 44;  
FIG. 46 is a bottom right front perspective view of a sixth embodiment of a sterile wrap showing our new design;  
FIG. 47 is a front elevation view thereof; the rear elevation view being a mirror image thereof;  
FIG. 48 is a right-side elevation view thereof; the left-side elevation view being a mirror image thereof;  
FIG. 49 is a top plan view thereof;  
FIG. 50 is a bottom plan view thereof;

FIG. 51 is an enlarged detail view of area 51 circumscribed within FIG. 46;  
FIG. 52 is an enlarged detail view of area 52 circumscribed within FIG. 49;  
FIG. 53 is an enlarged detail view of area 53 circumscribed within FIG. 49;  
FIG. 54 is a cross-section view taken along the line 54-54 in FIG. 53;  
FIG. 55 is a bottom right front perspective view of a seventh embodiment of a sterile wrap showing our new design;  
FIG. 56 is a front elevation view thereof; the rear elevation view being a mirror image thereof;  
FIG. 57 is a right-side elevation view thereof; the left-side elevation view being a mirror image thereof;  
FIG. 58 is a top plan view thereof;  
FIG. 59 is a bottom plan view thereof;  
FIG. 60 is an enlarged detail view of area 60 circumscribed within FIG. 55;  
FIG. 61 is an enlarged detail view of area 61 circumscribed within FIG. 58;  
FIG. 62 is an enlarged detail view of area 62 circumscribed within FIG. 58;  
FIG. 63 is a cross-section view taken along the line 63-63 in FIG. 62;  
FIG. 64 is a bottom right front perspective view of an eighth embodiment of a sterile wrap showing our new design;  
FIG. 65 is a front elevation view thereof; the rear elevation view being a mirror image thereof;  
FIG. 66 is a right-side elevation view thereof; the left-side elevation view being a mirror image thereof;  
FIG. 67 is a top plan view thereof;  
FIG. 68 is a bottom plan view thereof;  
FIG. 69 is an enlarged detail view of area 69 circumscribed within FIG. 64;  
FIG. 70 is an enlarged detail view of area 70 circumscribed within FIG. 67;  
FIG. 71 is an enlarged detail view of area 71 circumscribed within FIG. 67;  
FIG. 72 is a cross-section view taken along the line 72-72 in FIG. 71;  
FIG. 73 is a bottom right front perspective view of a ninth embodiment of a sterile wrap showing our new design;  
FIG. 74 is a front elevation view thereof; the rear elevation view being a mirror image thereof;  
FIG. 75 is a right-side elevation view thereof; the left-side elevation view being a mirror image thereof;  
FIG. 76 is a top plan view thereof;  
FIG. 77 is a bottom plan view thereof;  
FIG. 78 is an enlarged detail view of area 78 circumscribed within FIG. 73;  
FIG. 79 is an enlarged detail view of area 79 circumscribed within FIG. 76;  
FIG. 80 is an enlarged detail view of area 80 circumscribed within FIG. 76; and  
FIG. 81 is a cross-section view taken along the line 81-81 in FIG. 80;  
FIG. 82 is a bottom right front perspective view of a tenth embodiment of a sterile wrap showing our new design;  
FIG. 83 is a front elevation view thereof; the rear elevation view being a mirror image thereof;  
FIG. 84 is a right-side elevation view thereof; the left-side elevation view being a mirror image thereof;  
FIG. 85 is a top plan view thereof;  
FIG. 86 is a bottom plan view thereof;

FIG. 87 is an enlarged detail view of area 87 circumscribed within FIG. 82;  
 FIG. 88 is an enlarged detail view of area 88 circumscribed within FIG. 85;  
 FIG. 89 is an enlarged detail view of area 89 circumscribed within FIG. 85; and,  
 FIG. 90 is a cross-section view taken along the line 90-90 in FIG. 89.

The dot-dash broken lines in the figures depict the boundaries of the enlarged detail views of the claimed design and form no part thereof.

**1 Claim, 40 Drawing Sheets  
 (40 of 40 Drawing Sheet(s) Filed in Color)**

(58) **Field of Classification Search**

USPC ..... D5/54, 56-66, 99; D25/102, 138, 139;  
 D19/5; D6/575, 577, 576, 582-589, 595,  
 D6/596, 608; D24/124, 188-190, 217;  
 D32/40, 55, 57  
 CPC ... B31F 1/00; B31F 1/07; B32B 3/266; B32B  
 5/024; B44F 1/00; B44F 1/02; B44F  
 1/08; B44F 1/10; B44F 5/00; B44F 7/00;  
 B44F 9/00; B44F 9/04; B44F 11/00;  
 B44F 11/02; B44F 11/04; D03D 1/00;  
 D04H 1/00; D10B 2503/04; D21H 27/02  
 See application file for complete search history.

(56) **References Cited**

U.S. PATENT DOCUMENTS

|           |     |         |               |       |                          |
|-----------|-----|---------|---------------|-------|--------------------------|
| 3,768,725 | A * | 10/1973 | Pilaro        | ..... | A61L 2/26<br>206/439     |
| 3,819,106 | A * | 6/1974  | Schuster      | ..... | A61B 10/0096<br>206/439  |
| 4,270,658 | A * | 6/1981  | Schuster      | ..... | B65D 31/02<br>206/439    |
| 4,367,816 | A * | 1/1983  | Wilkes        | ..... | A61B 50/30<br>206/439    |
| 4,510,640 | A * | 4/1985  | Omori         | ..... | A47L 13/18<br>15/104.002 |
| 4,644,586 | A * | 2/1987  | Padgett       | ..... | A61L 2/26<br>206/439     |
| 4,874,090 | A * | 10/1989 | Dyke          | ..... | A61L 2/26<br>206/439     |
| 5,222,600 | A * | 6/1993  | Stoddard      | ..... | A61L 2/26<br>206/369     |
| D375,844  | S * | 11/1996 | Edwards       | ..... | D5/1                     |
| 5,635,134 | A   | 6/1997  | Bourne et al. |       |                          |
| 5,688,476 | A   | 11/1997 | Bourne et al. |       |                          |
| D389,581  | S * | 1/1998  | Fein          | ..... | D24/189                  |
| D459,093  | S * | 6/2002  | Forin         | ..... | D5/57                    |

|              |      |         |                    |       |                        |
|--------------|------|---------|--------------------|-------|------------------------|
| 6,406,674    | B1 * | 6/2002  | Bourne             | ..... | A61L 2/26<br>206/439   |
| 7,718,433    | B2 * | 5/2010  | Stecklein          | ..... | A61L 2/07<br>422/119   |
| D647,309     | S *  | 10/2011 | Kuehn              | ..... | D5/58                  |
| D659,324     | S *  | 5/2012  | Davis              | ..... | D32/40                 |
| D699,908     | S *  | 2/2014  | Fang               | ..... | D32/40                 |
| 8,783,003    | B2   | 7/2014  | Czajka, Jr. et al. |       |                        |
| 8,852,502    | B2 * | 10/2014 | Landgrebe          | ..... | A61L 2/26<br>422/1     |
| D728,245     | S *  | 5/2015  | Haverfield         | ..... | D5/60                  |
| D742,249     | S *  | 11/2015 | Farmer             | ..... | D9/713                 |
| D747,220     | S *  | 1/2016  | Farmer             | ..... | D9/713                 |
| 2002/0124947 | A1   | 9/2002  | Kim                |       |                        |
| 2002/0197424 | A1 * | 12/2002 | Bayer              | ..... | A61L 2/26<br>428/34.2  |
| 2003/0196921 | A1   | 10/2003 | Giordano           |       |                        |
| 2004/0261373 | A1   | 12/2004 | Bowen et al.       |       |                        |
| 2005/0079093 | A1   | 4/2005  | Cannady et al.     |       |                        |
| 2005/0163654 | A1   | 7/2005  | Stecklein et al.   |       |                        |
| 2005/0170726 | A1   | 8/2005  | Brunson et al.     |       |                        |
| 2006/0067855 | A1   | 3/2006  | Mathis et al.      |       |                        |
| 2006/0104856 | A1   | 5/2006  | Farrell et al.     |       |                        |
| 2006/0104857 | A1   | 5/2006  | Pigott et al.      |       |                        |
| 2007/0128094 | A1 * | 6/2007  | Paris-Jolly        | ..... | A61L 2/26<br>422/292   |
| 2007/0224409 | A1   | 9/2007  | Dovorany et al.    |       |                        |
| 2008/0083426 | A1   | 4/2008  | Sachdev et al.     |       |                        |
| 2009/0235833 | A1 * | 9/2009  | Shi                | ..... | B41C 1/148<br>101/129  |
| 2011/0033137 | A1   | 2/2011  | Gaynor et al.      |       |                        |
| 2013/0171427 | A1   | 7/2013  | Pamperin et al.    |       |                        |
| 2013/0240399 | A1 * | 9/2013  | Czajka, Jr.        | ..... | A61L 2/26<br>206/459.1 |

OTHER PUBLICATIONS

Examination Report for New Zealand Application No. 420783, dated Oct. 30, 2015.  
 Examination Report for New Zealand Application No. 420784, dated Oct. 30, 2015.  
 "Medline Launches Stronger Bonded Sterilization Wrap for Greater Reassurance of Sterilization Process", <https://www.medline.com/pages/press-releases/2014/09/medline-launches-stronger-bonded-sterilization-wrap-for-greater-reassurance-of-sterilization-process>, dated Sep. 2, 2014.  
 "Gemini Bonded Wrap", Medline Industries, Inc., <http://www.medline.com/products/central-sterile/gemini-bonded-wrap>, accessed Oct. 22, 2015.  
 Google image search results displaying links to two website pages which have associated dates of Dec. 11, 2014 and Feb. 5, 2015.  
 Kimberly-Clark Health Care Introduces Kinguard\* Sterilization Wrap for Confident Inspection; Roswell, GA and New Orleans, Mar. 26, 2012/PRNewswire; <http://www.kchealthcare.com>, 2 pages.  
 International Search Report and Written Opinion dated Jun. 21, 2013 from PCT/US2013/029373, 9 pages.

\* cited by examiner

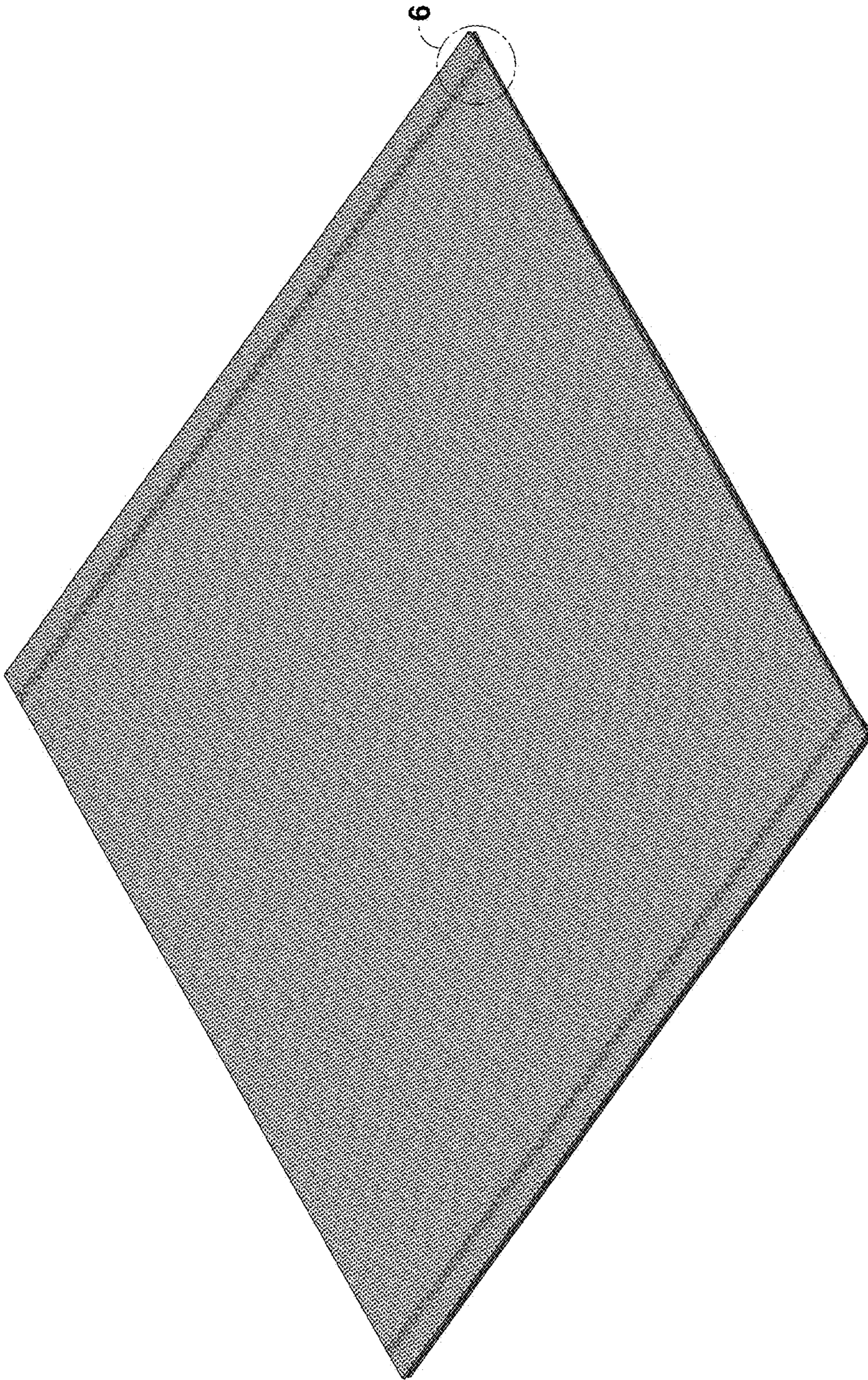

FIG. 1

---

FIG. 2

---

FIG. 3

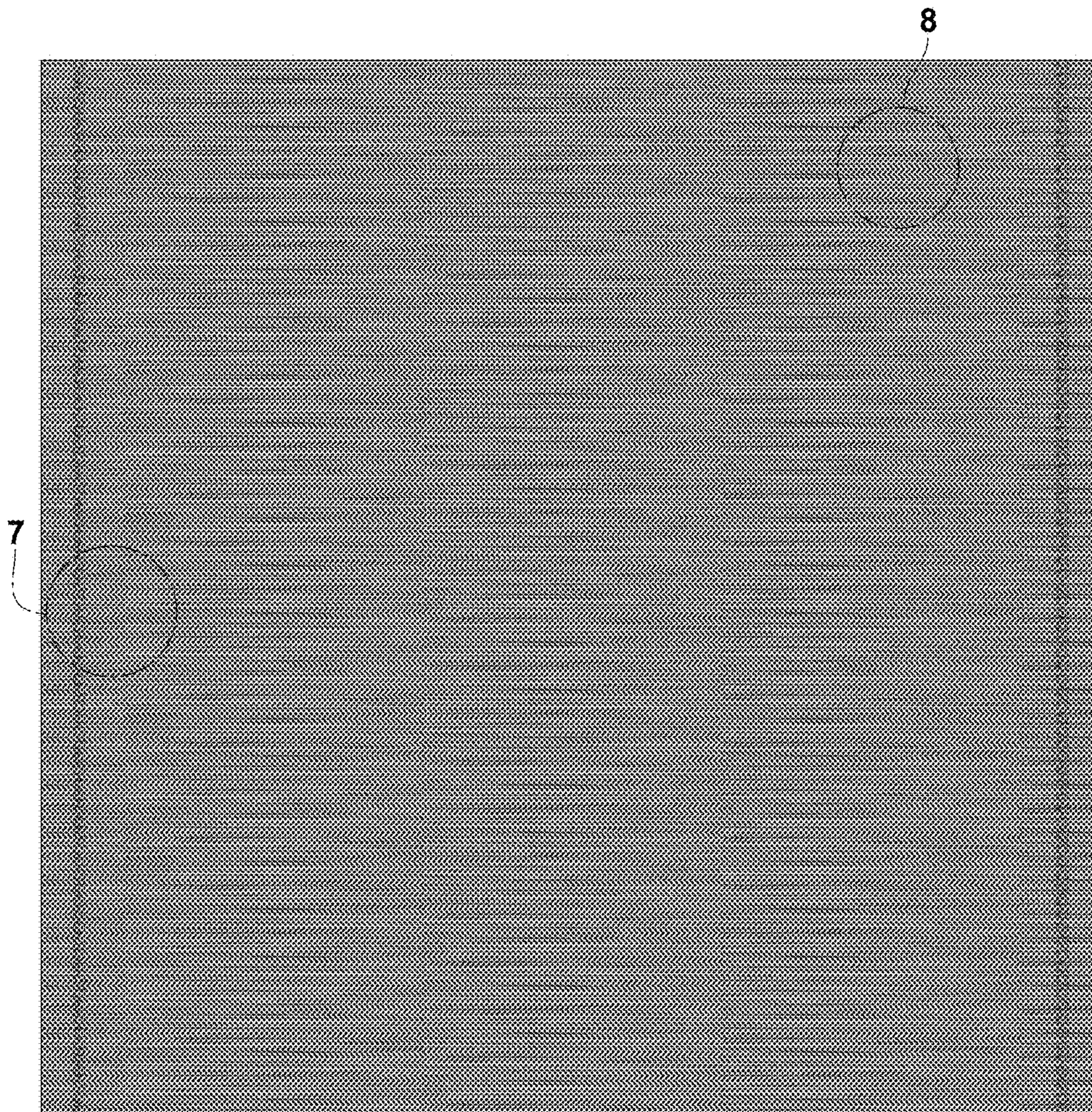

FIG. 4

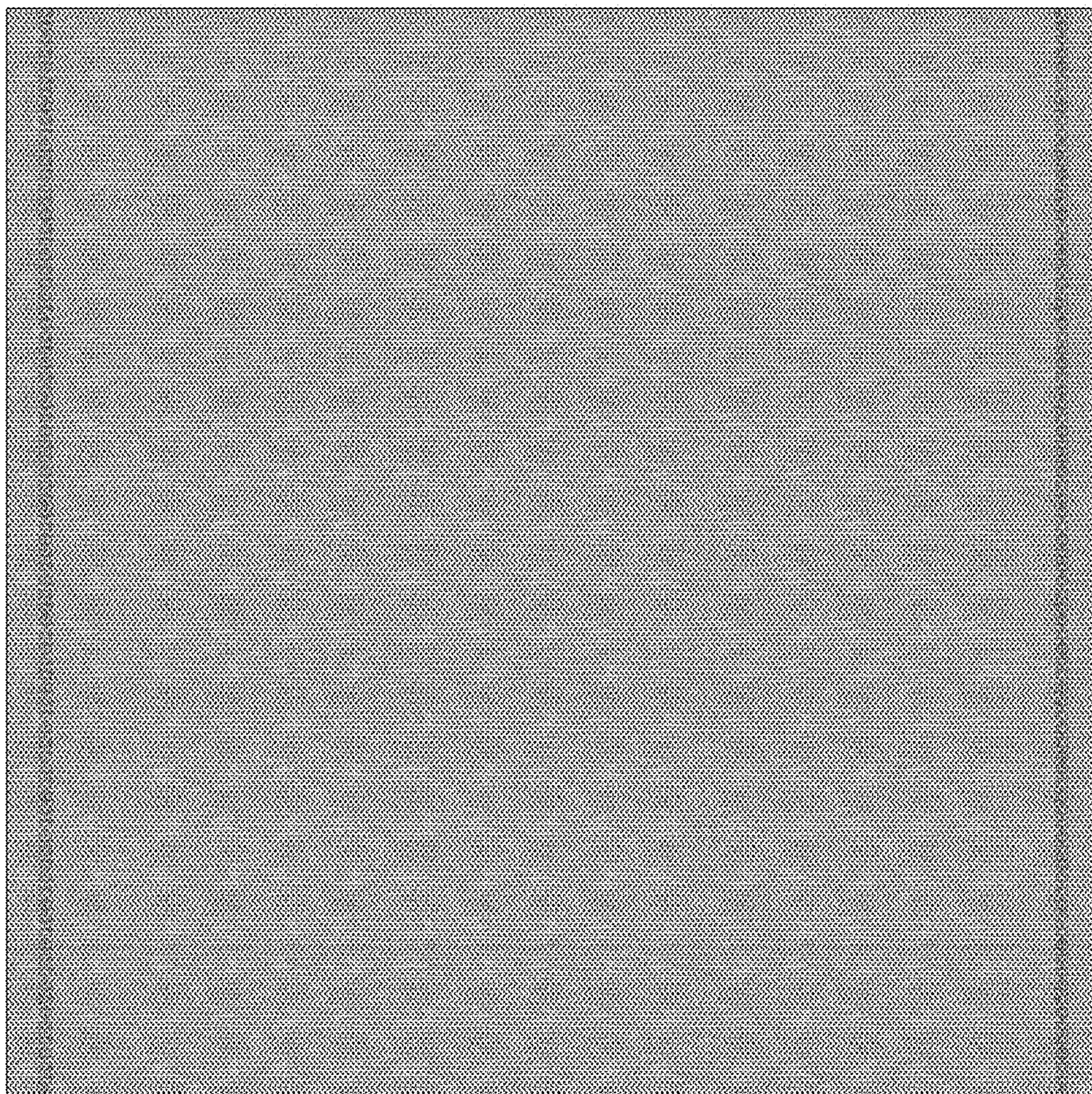

FIG. 5

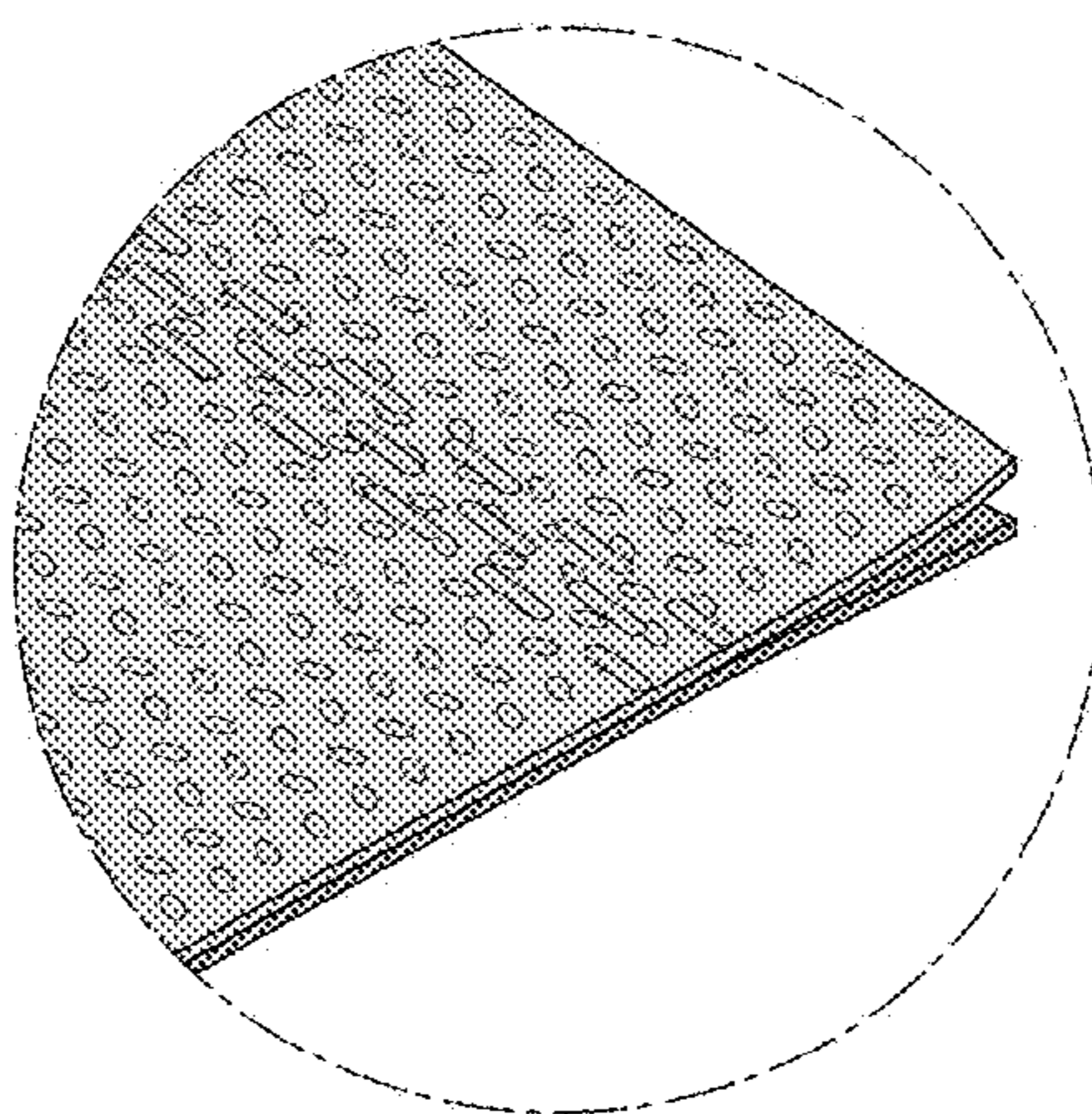

FIG. 6

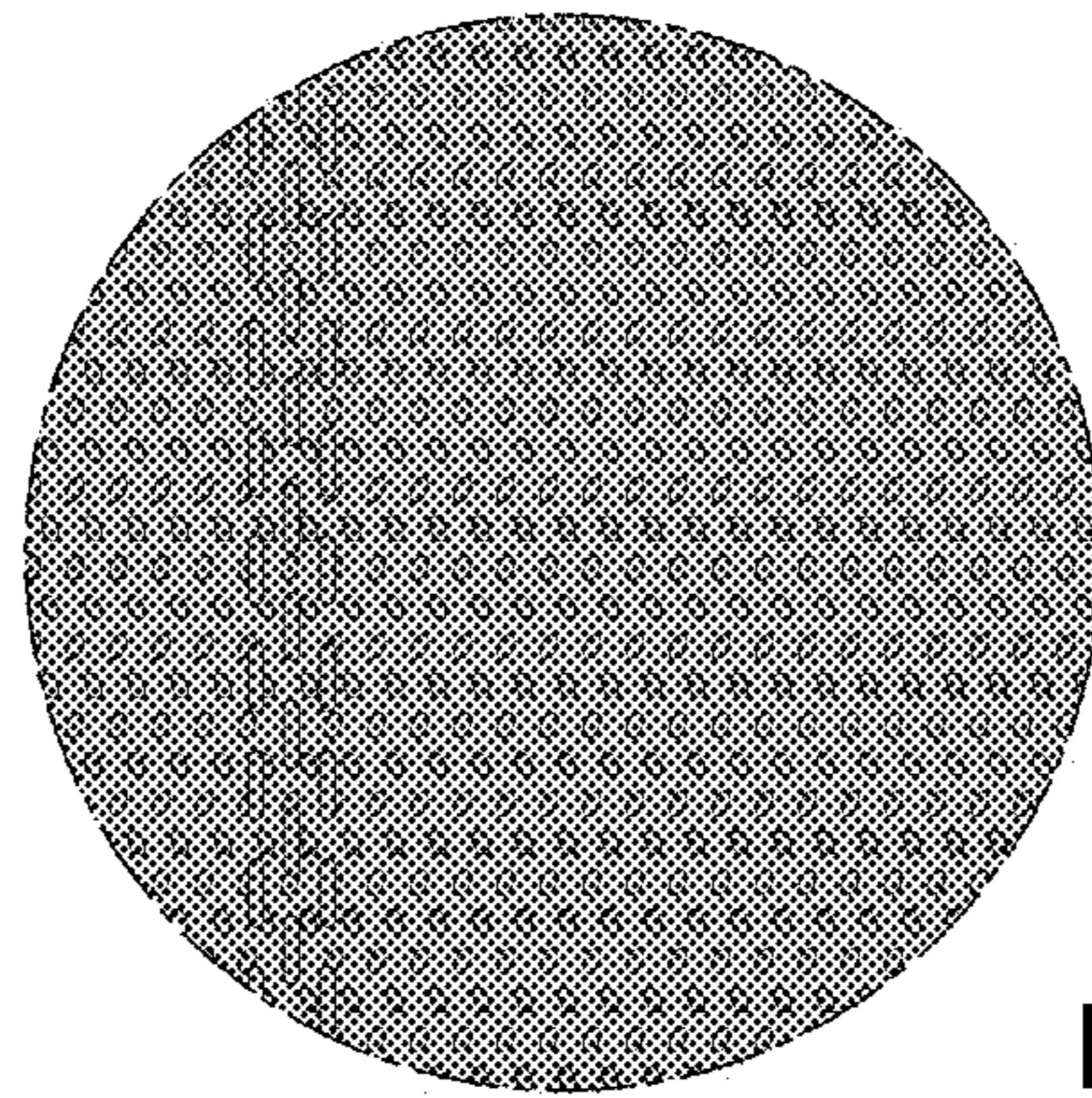

FIG. 7

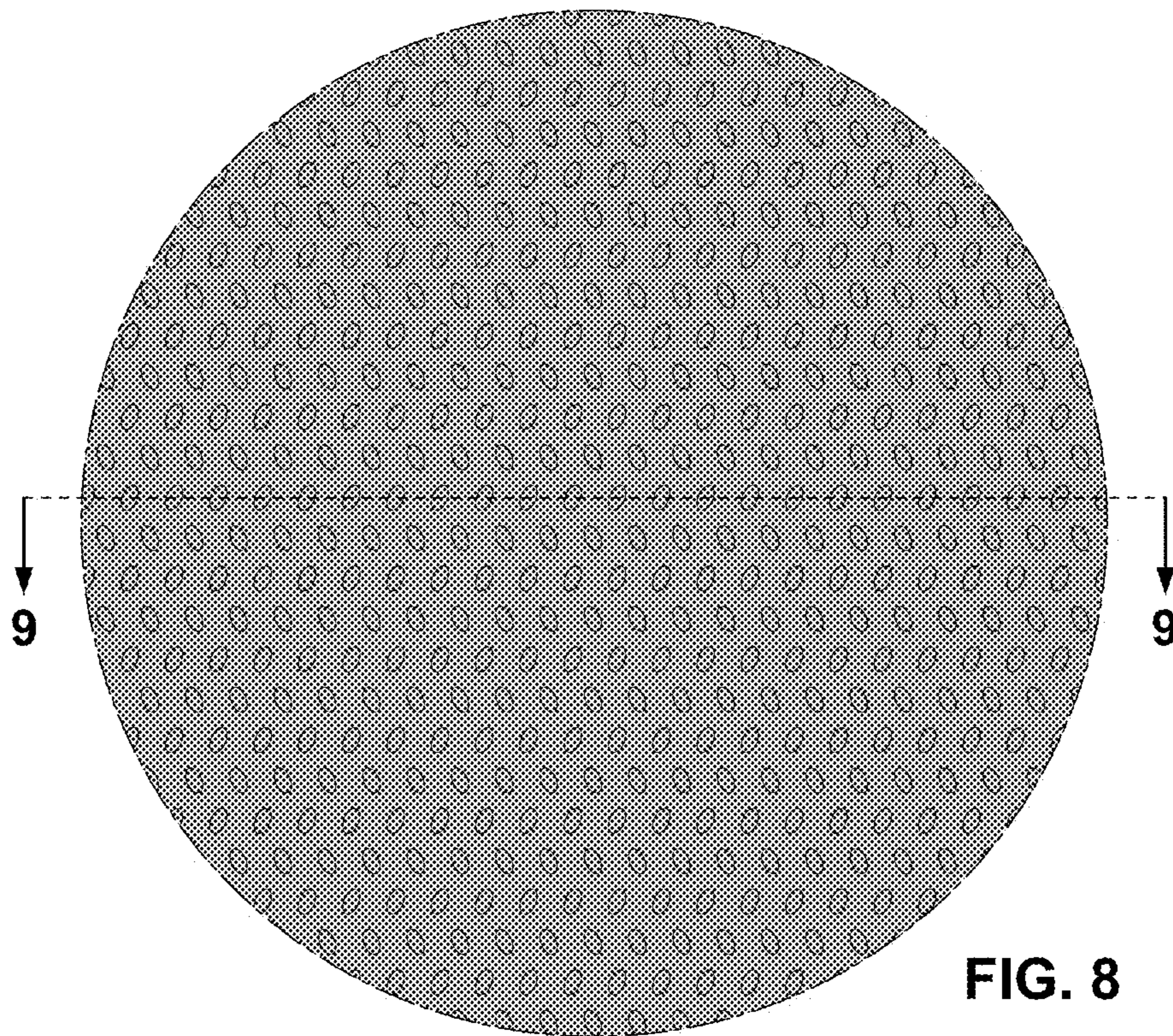

FIG. 8

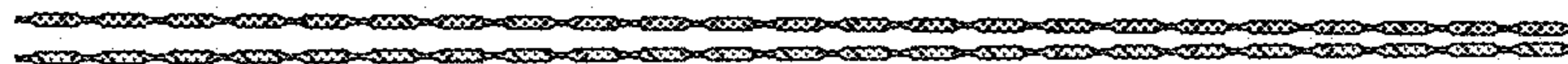

FIG. 9

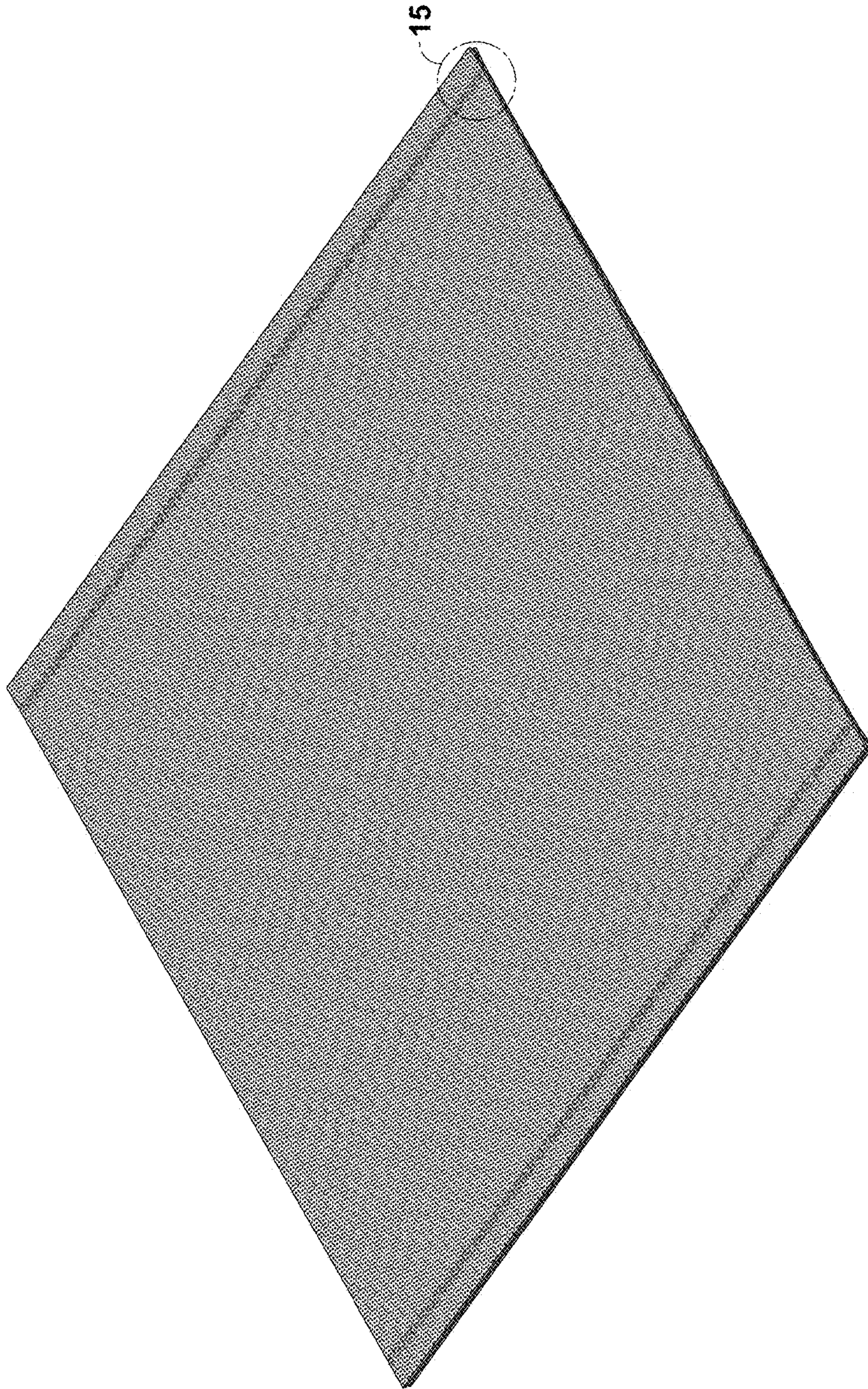

FIG. 10



---

FIG. 11

---

FIG. 12

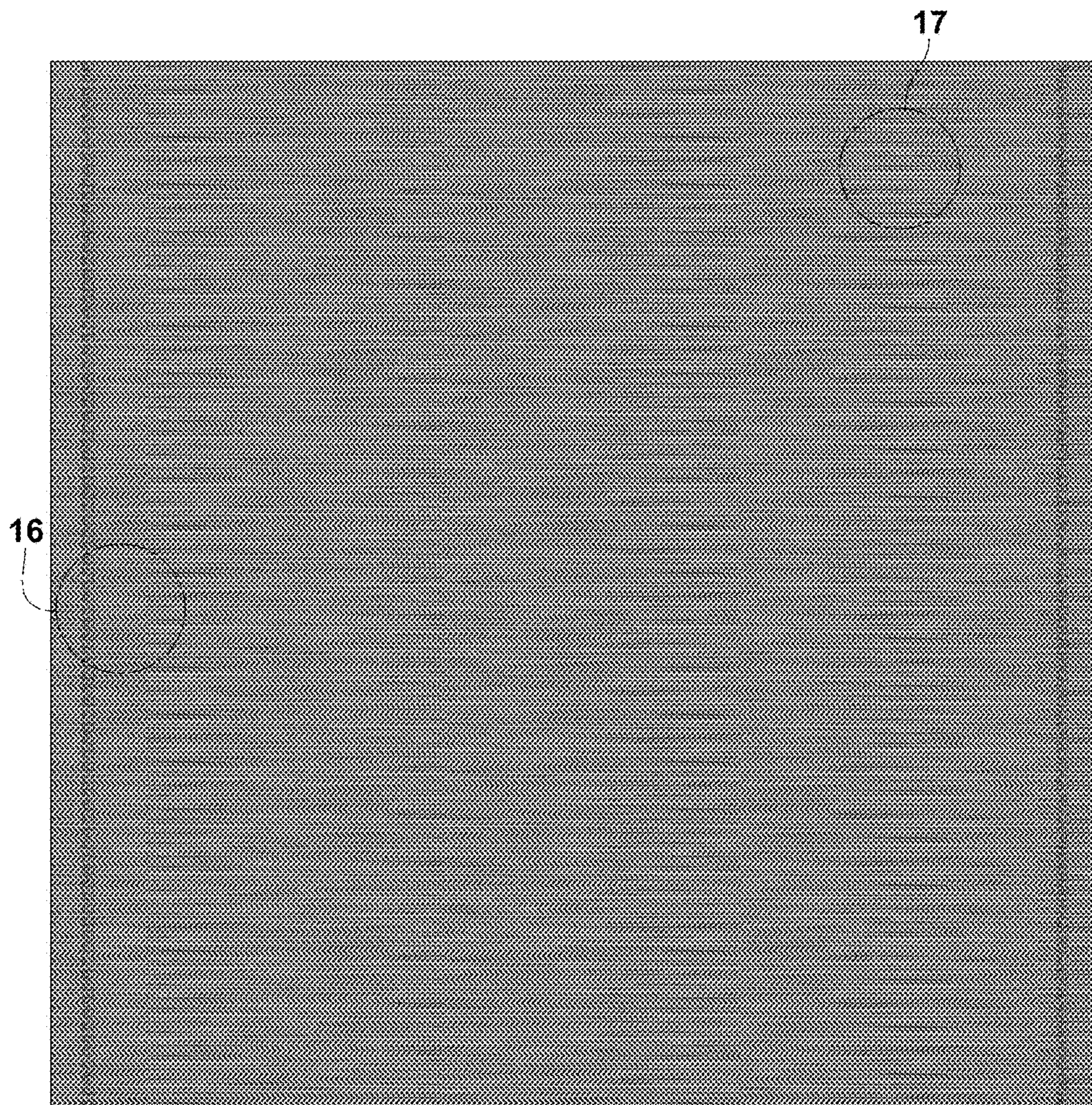

FIG. 13

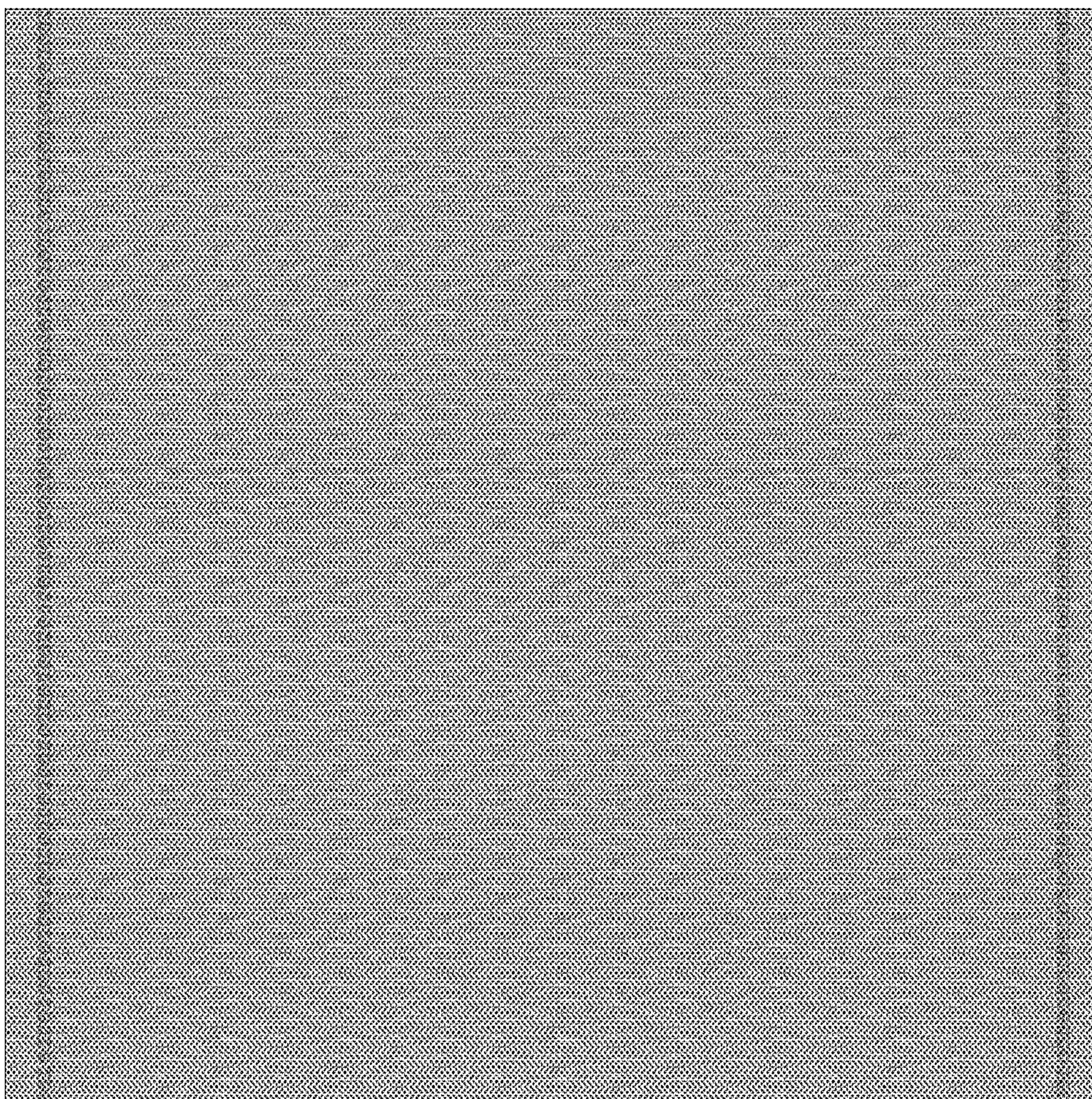

FIG. 14

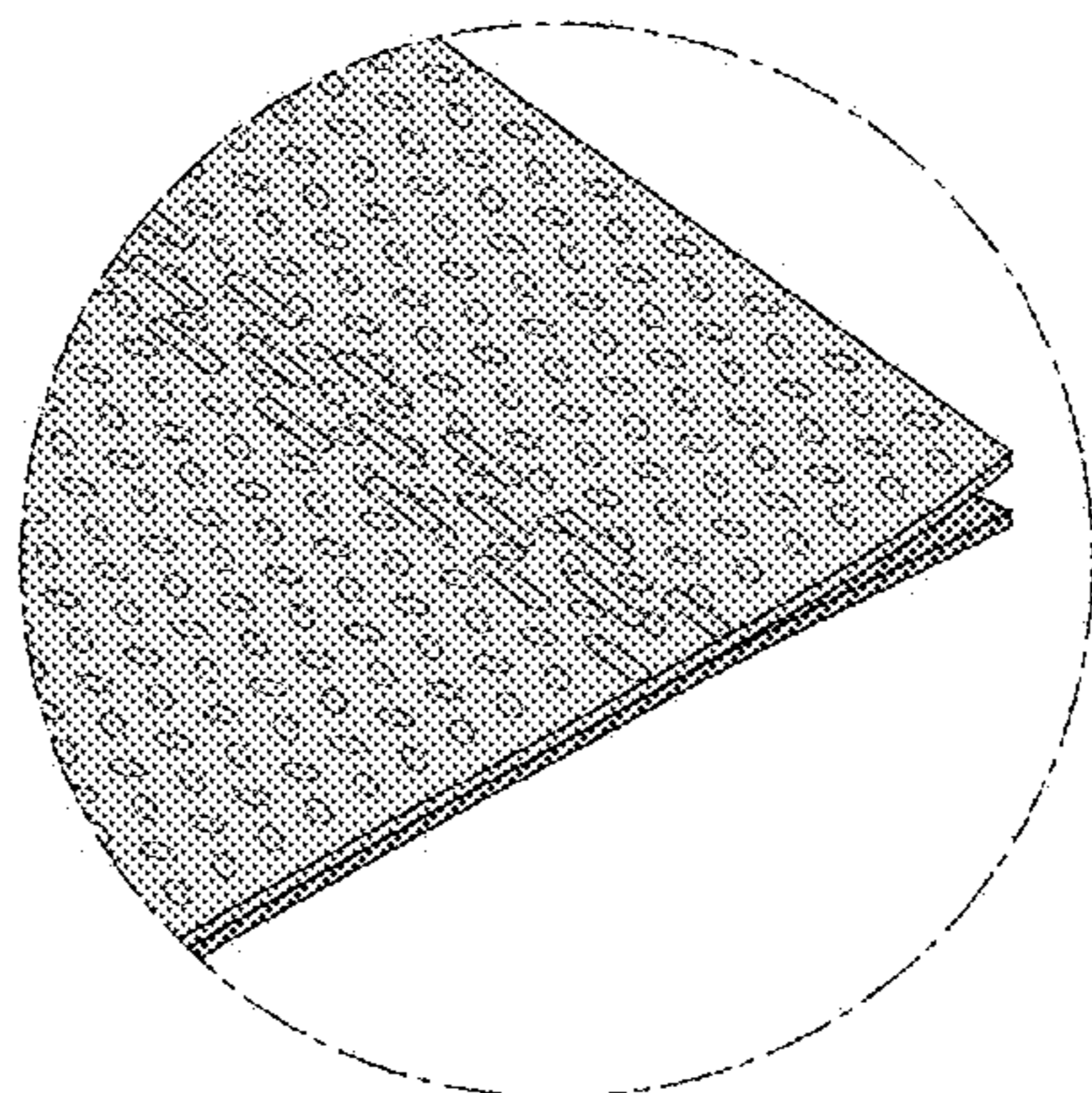

FIG. 15

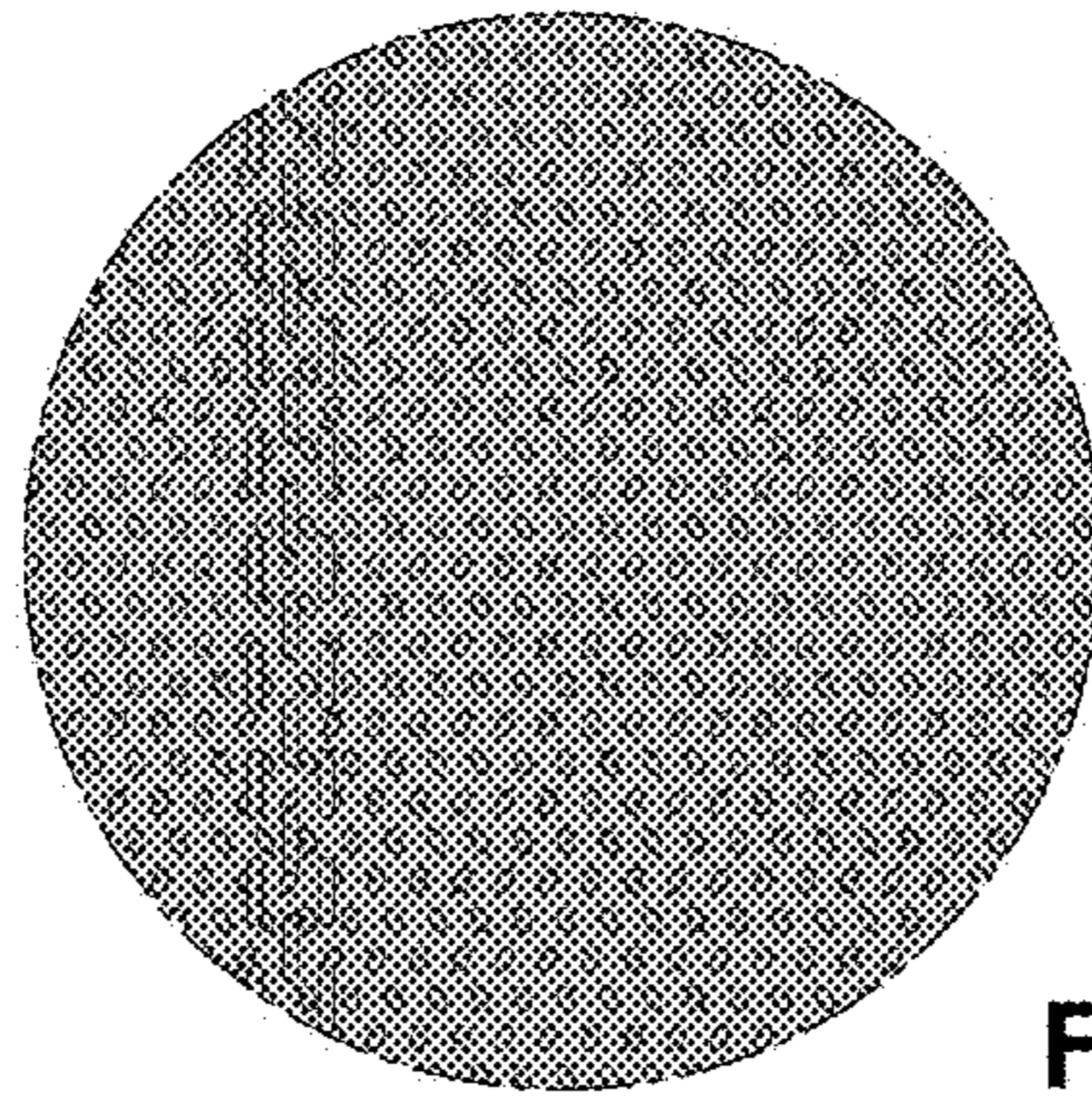

FIG. 16

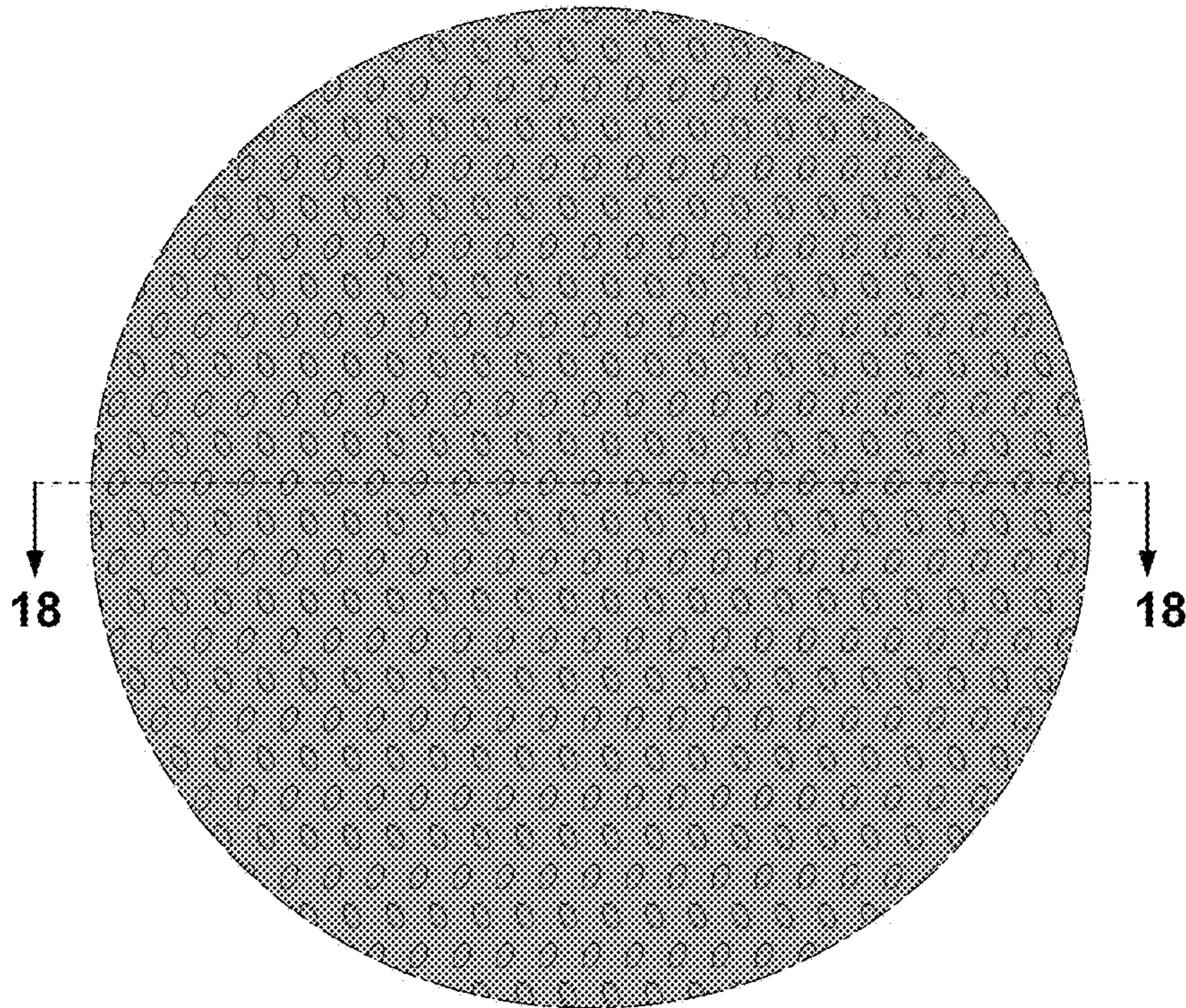

FIG. 17

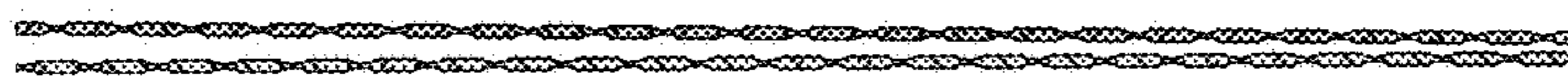

FIG. 18

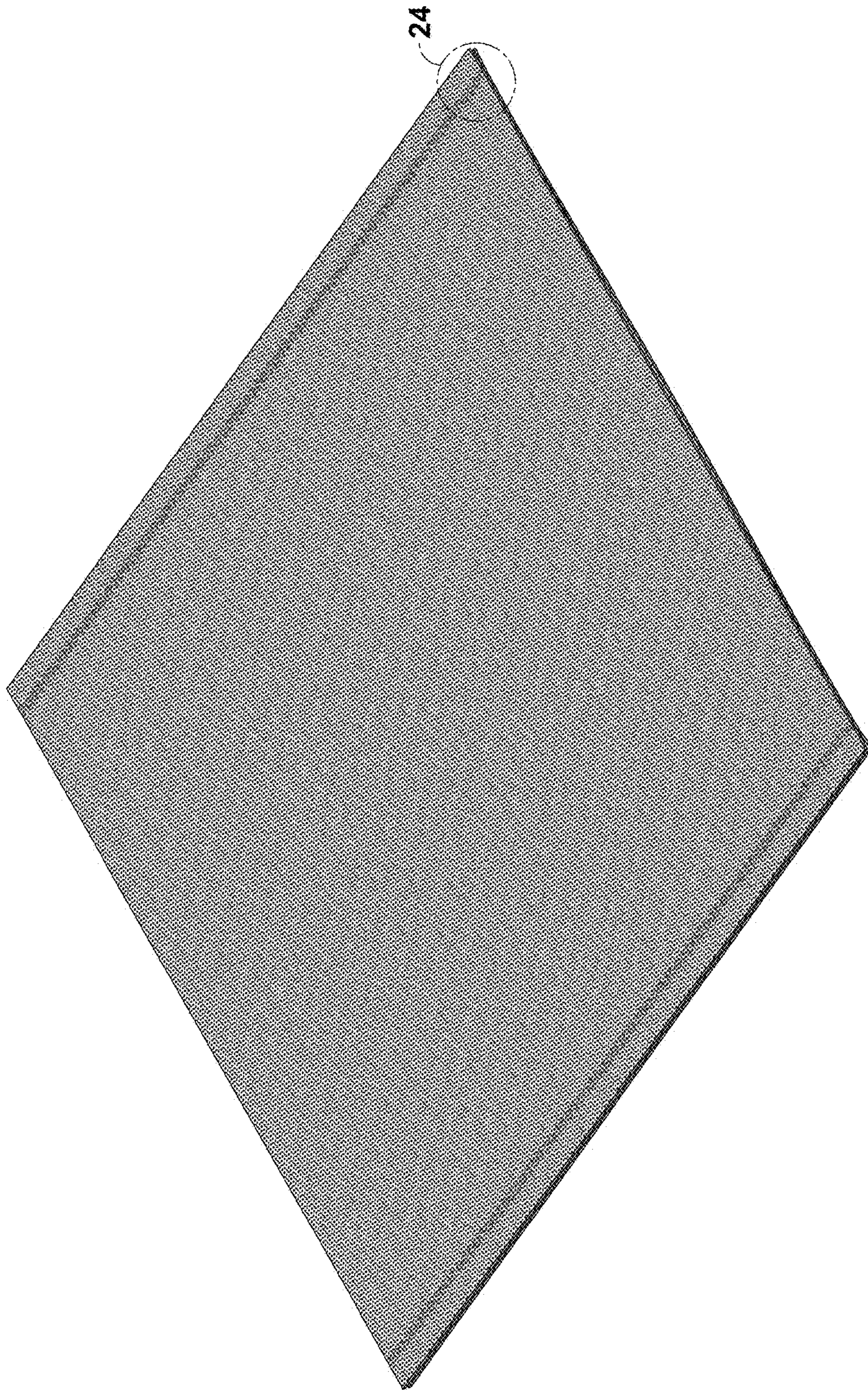

FIG. 19

---

FIG. 20

---

FIG. 21

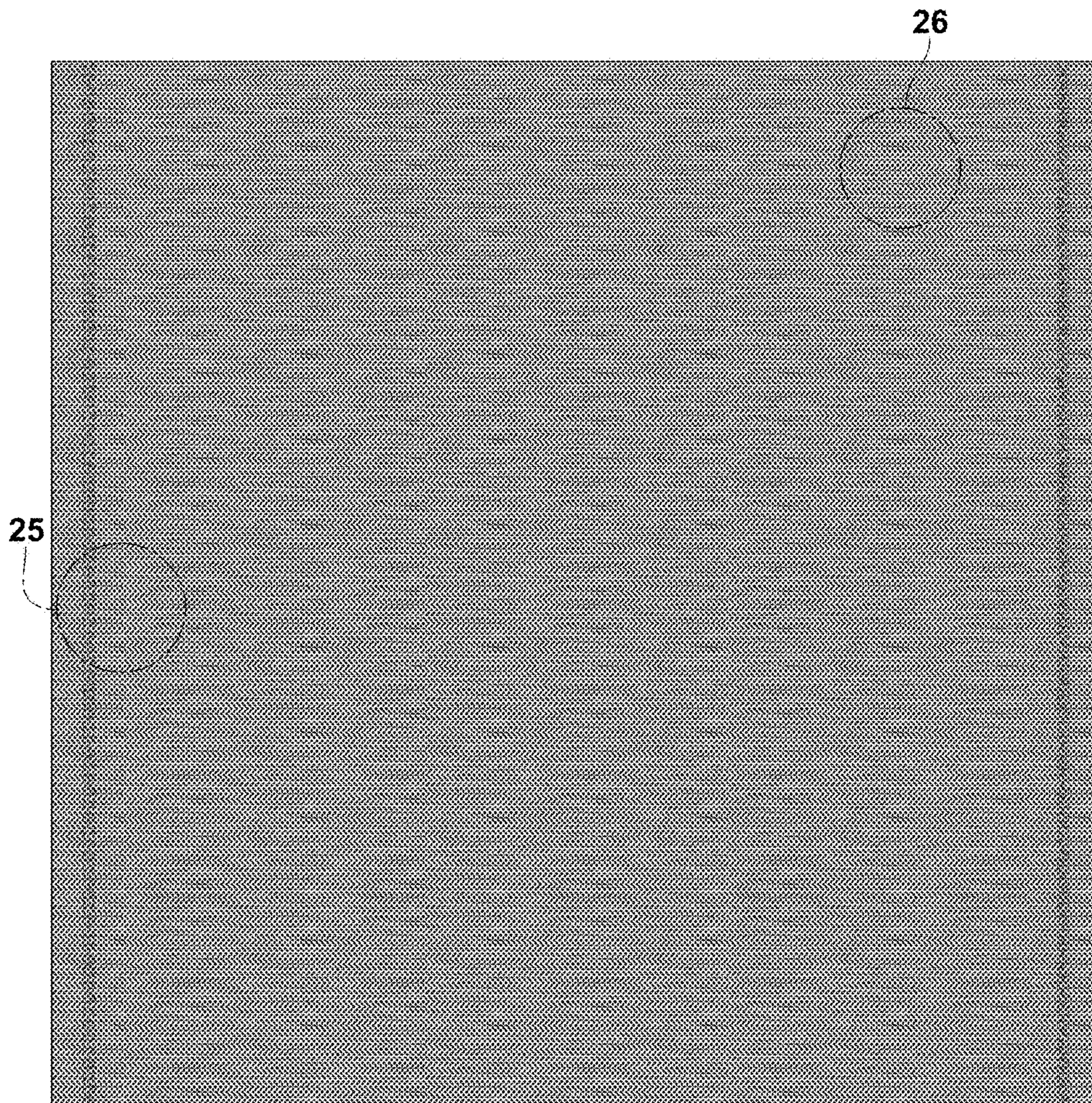

FIG. 22

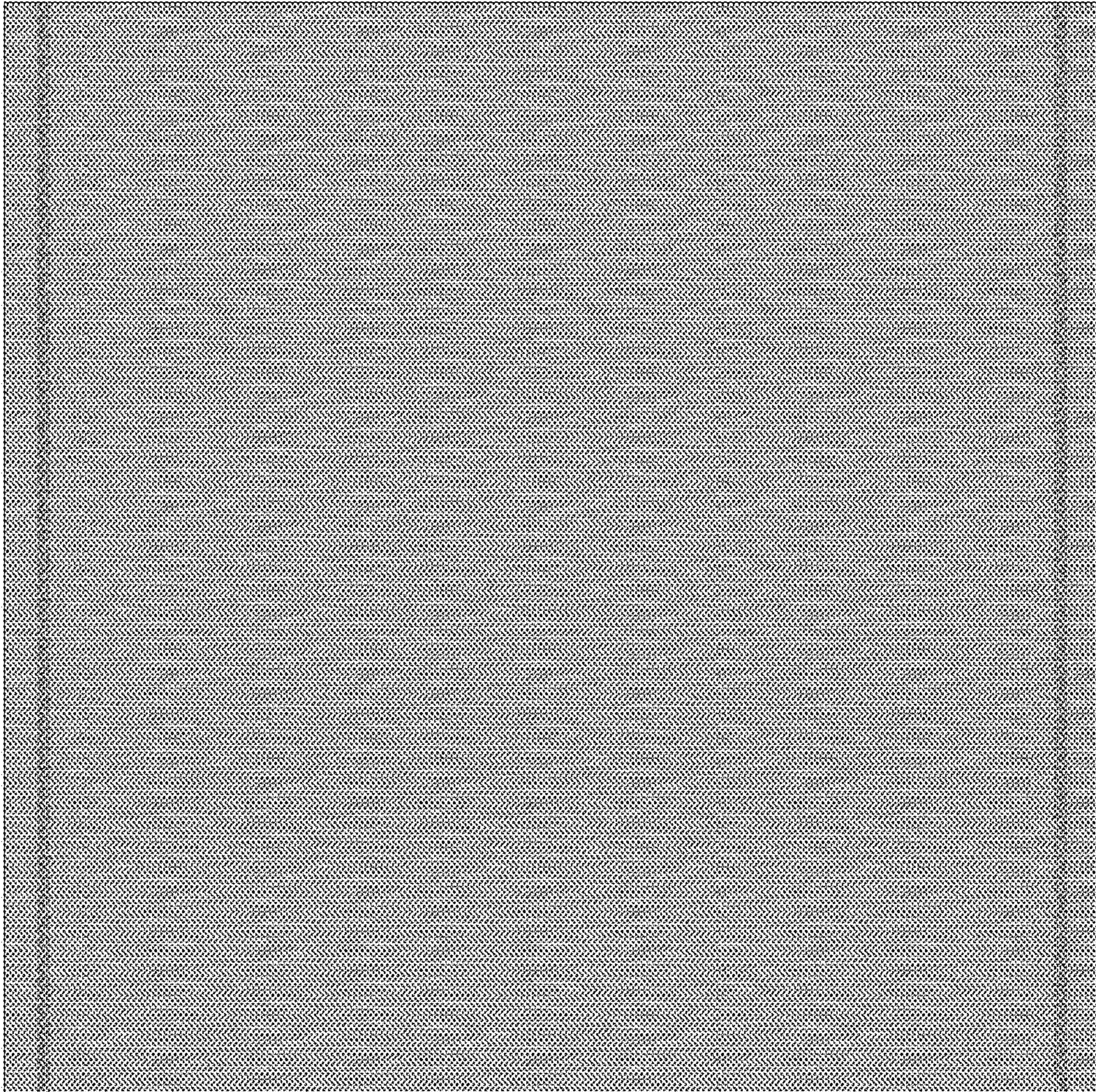

FIG. 23

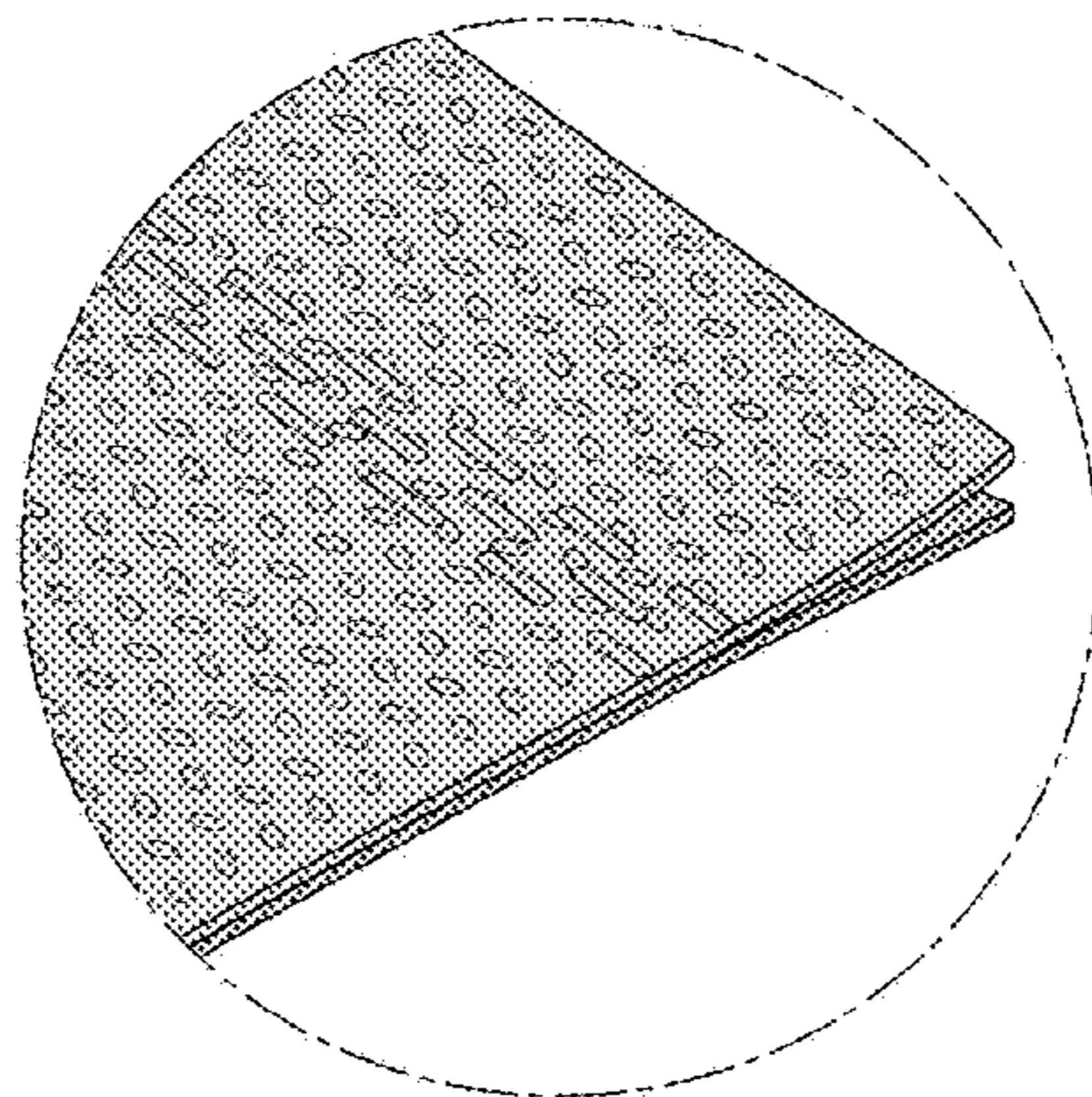

FIG. 24

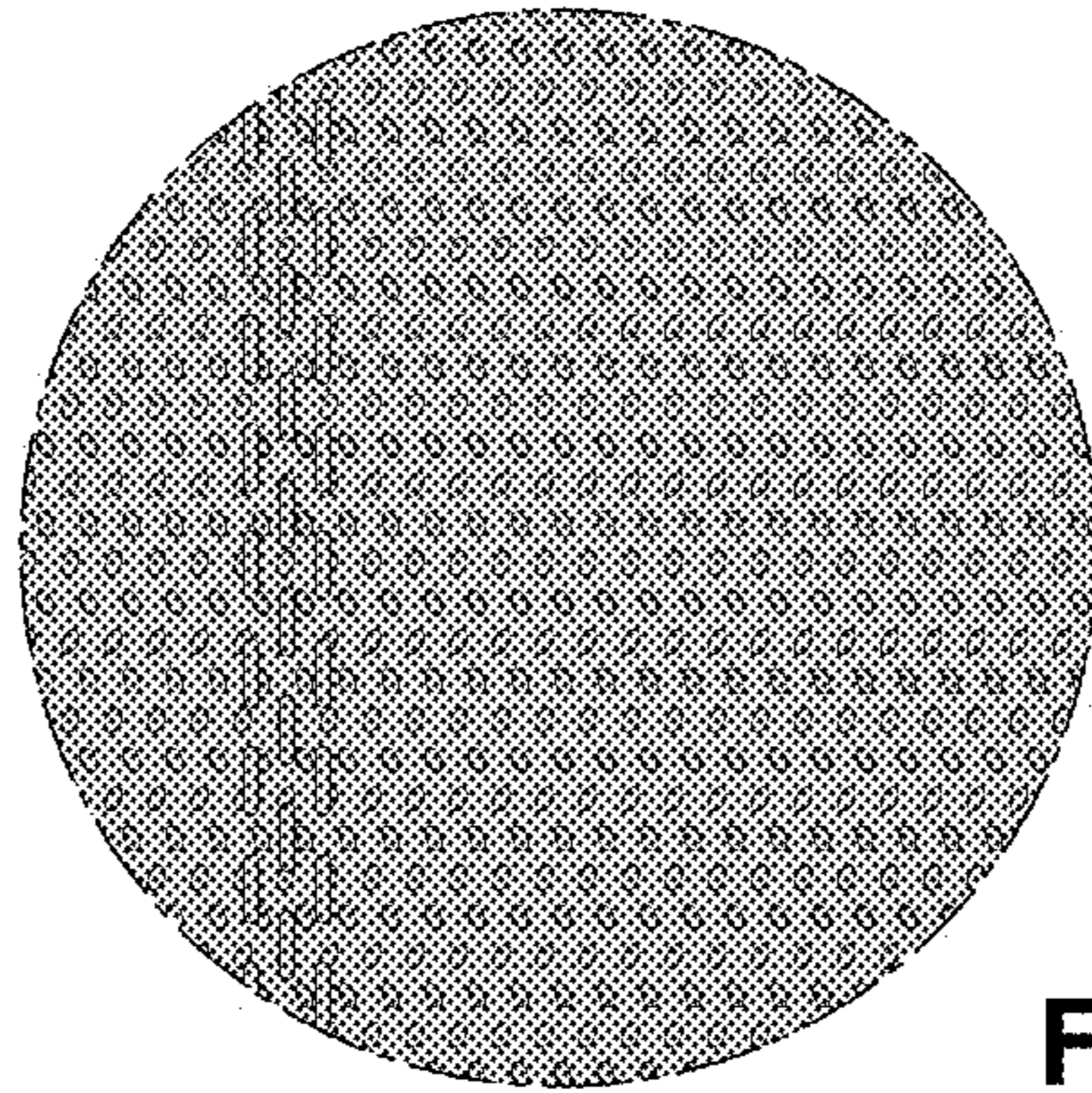

FIG. 25

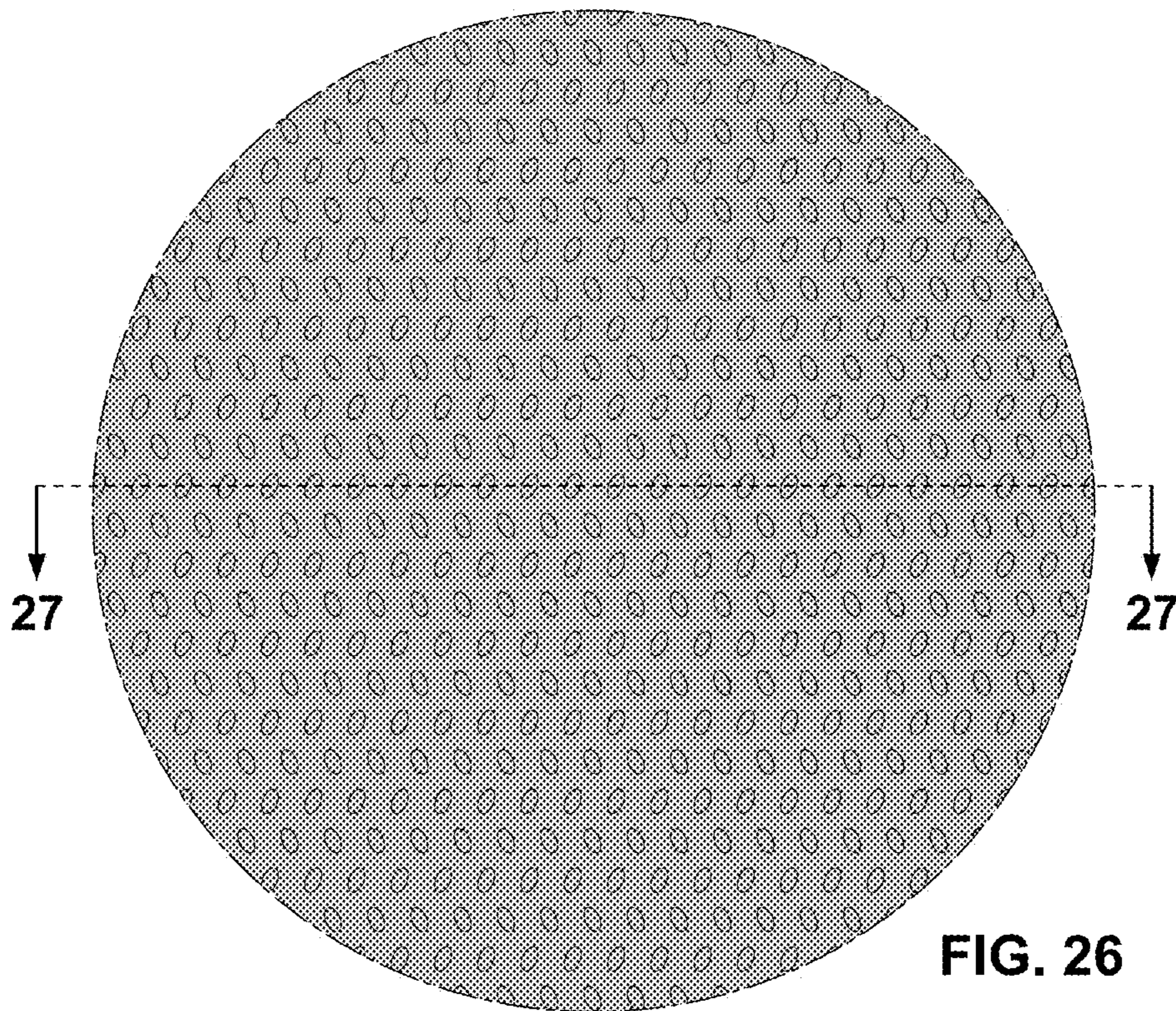

FIG. 26

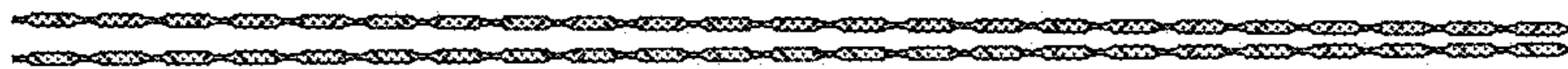

FIG. 27

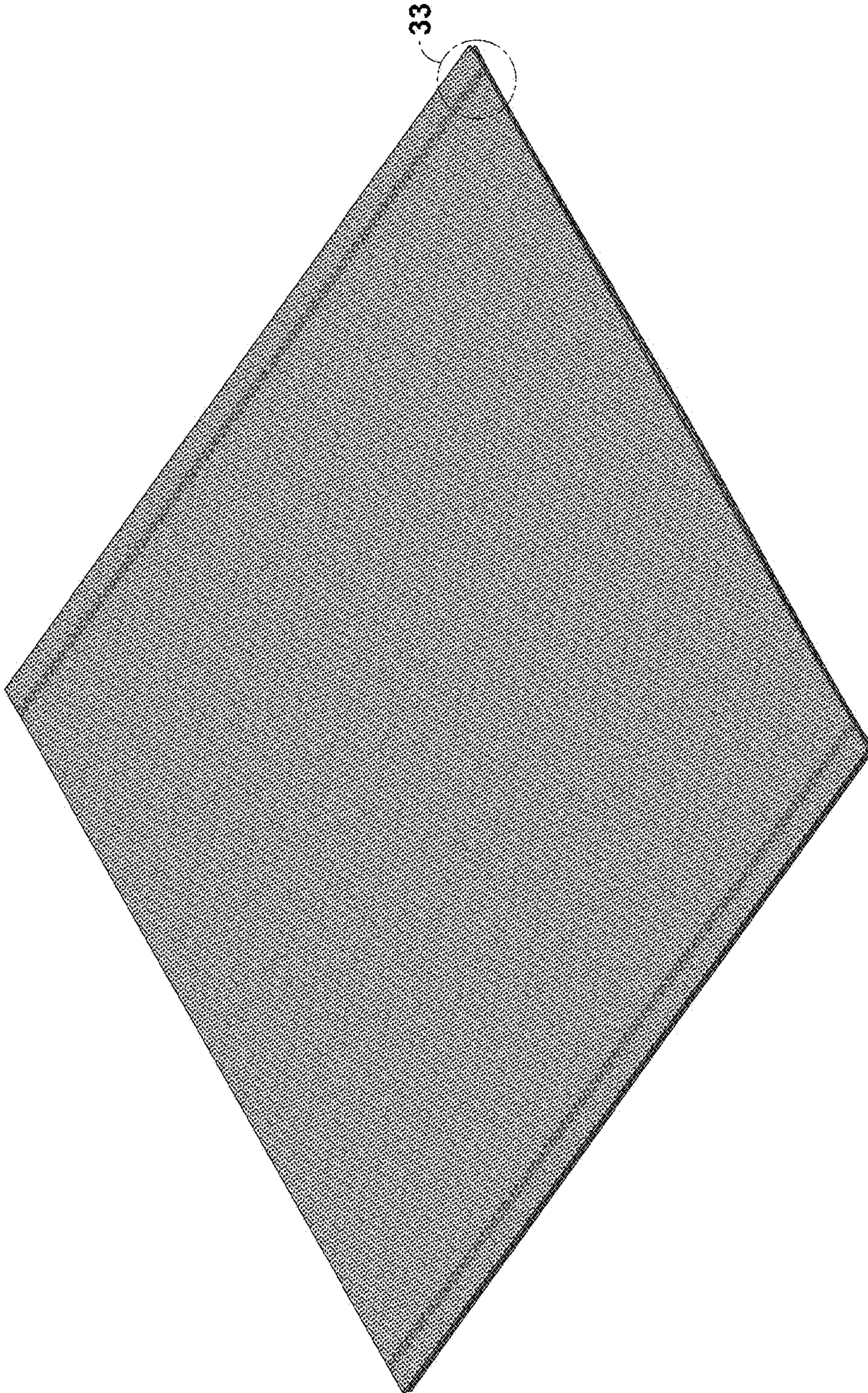

FIG. 28



---

FIG. 29

---

FIG. 30

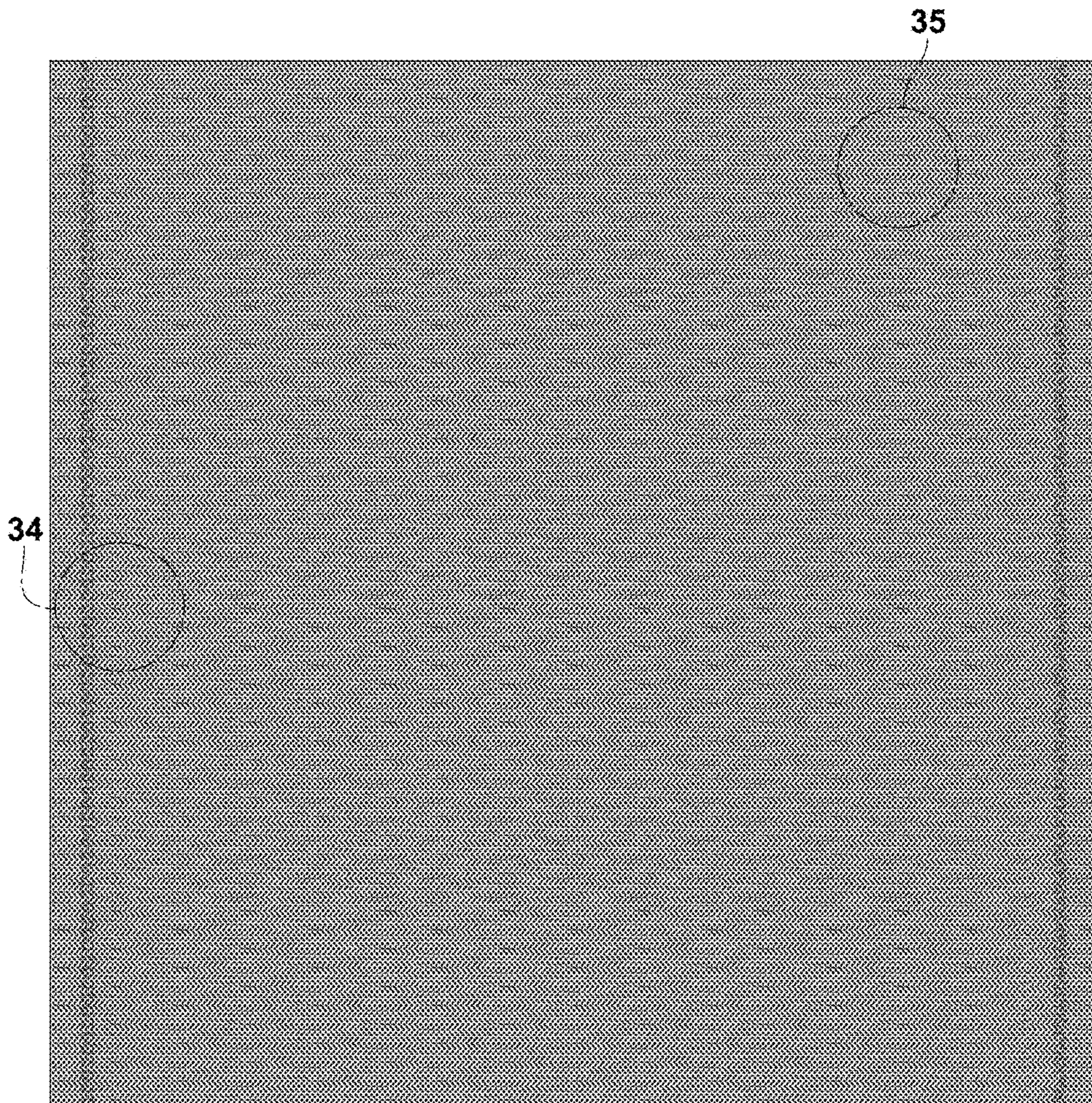

FIG. 31

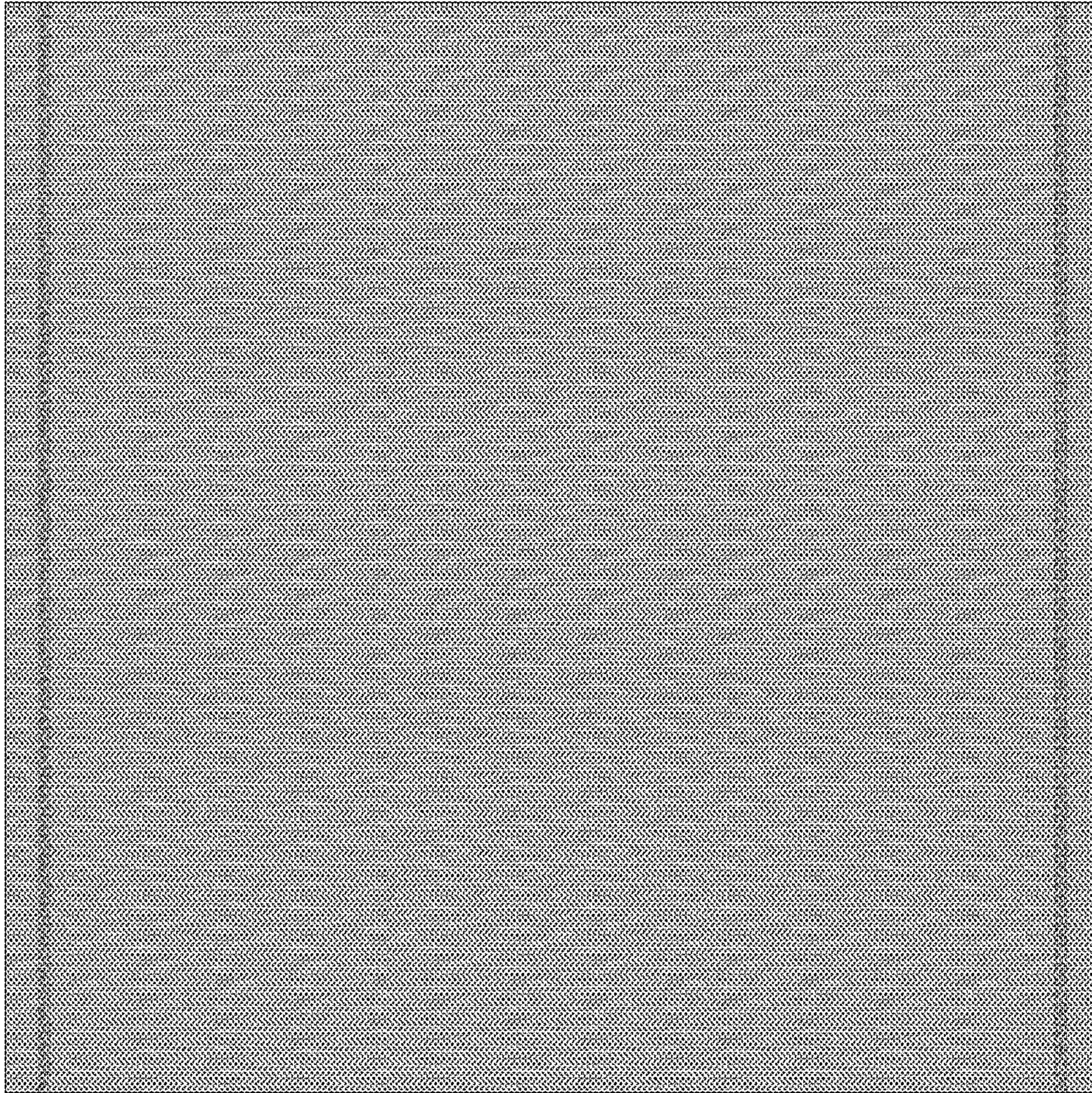

FIG. 32

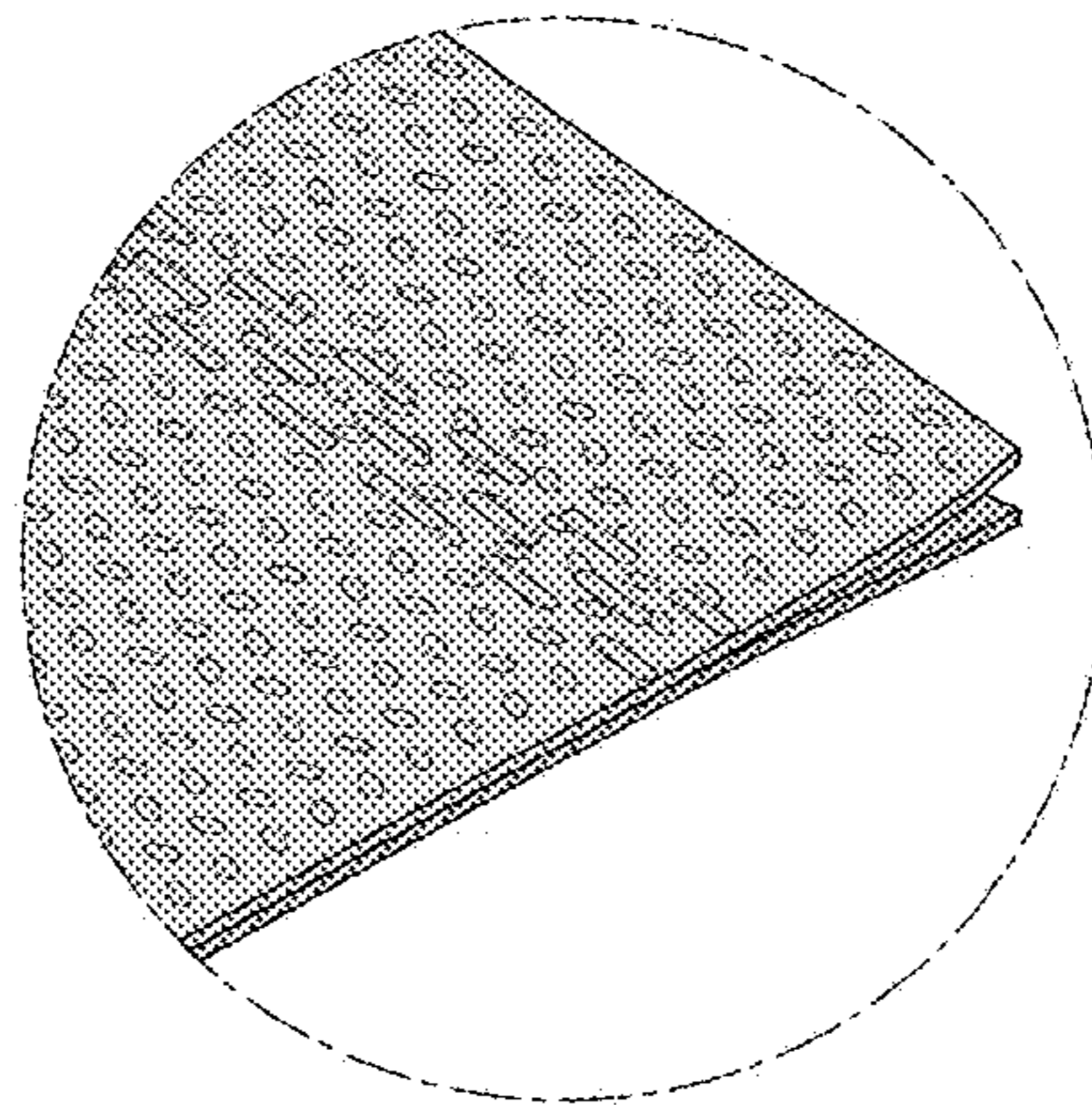

FIG. 33

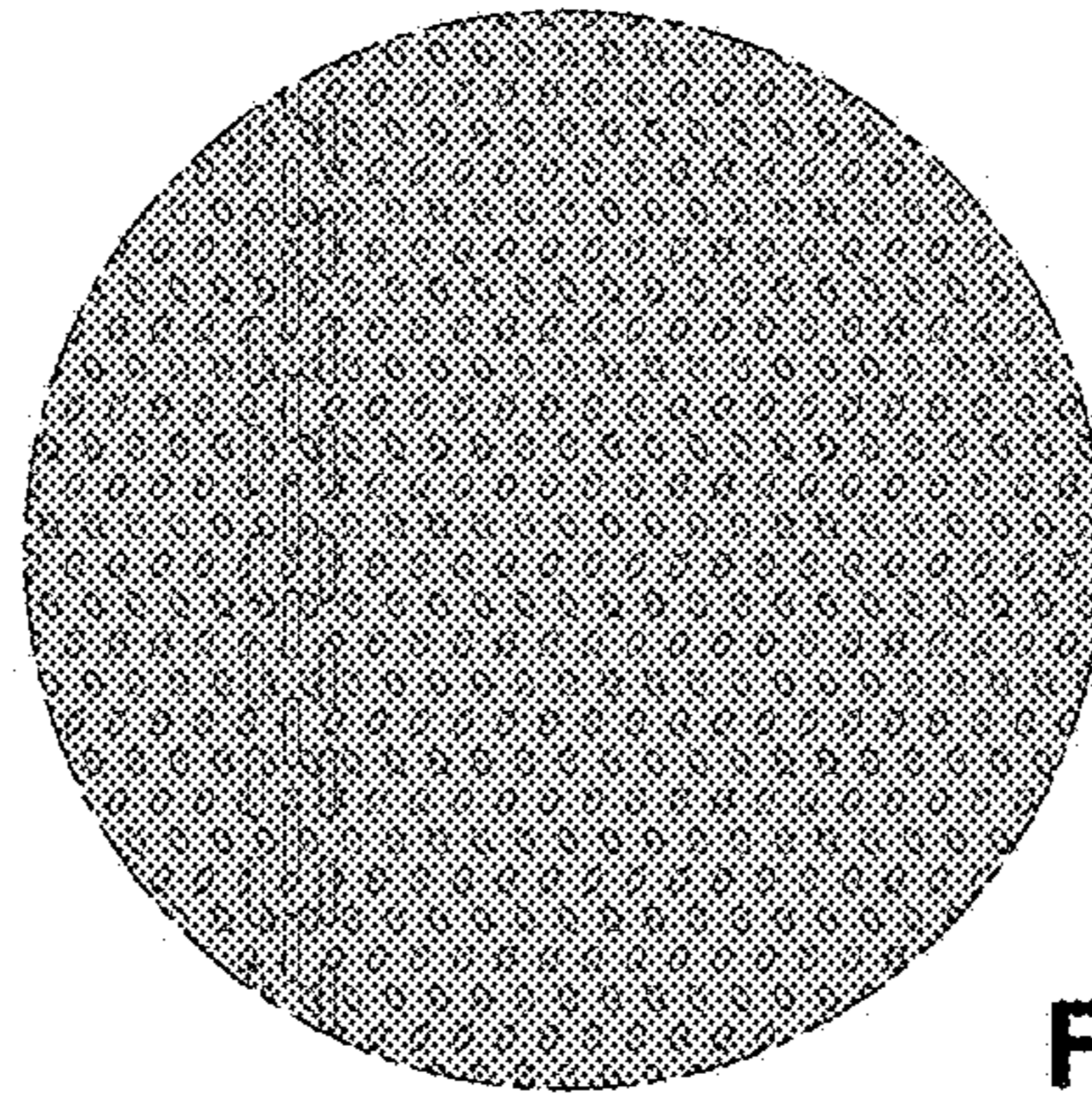

FIG. 34

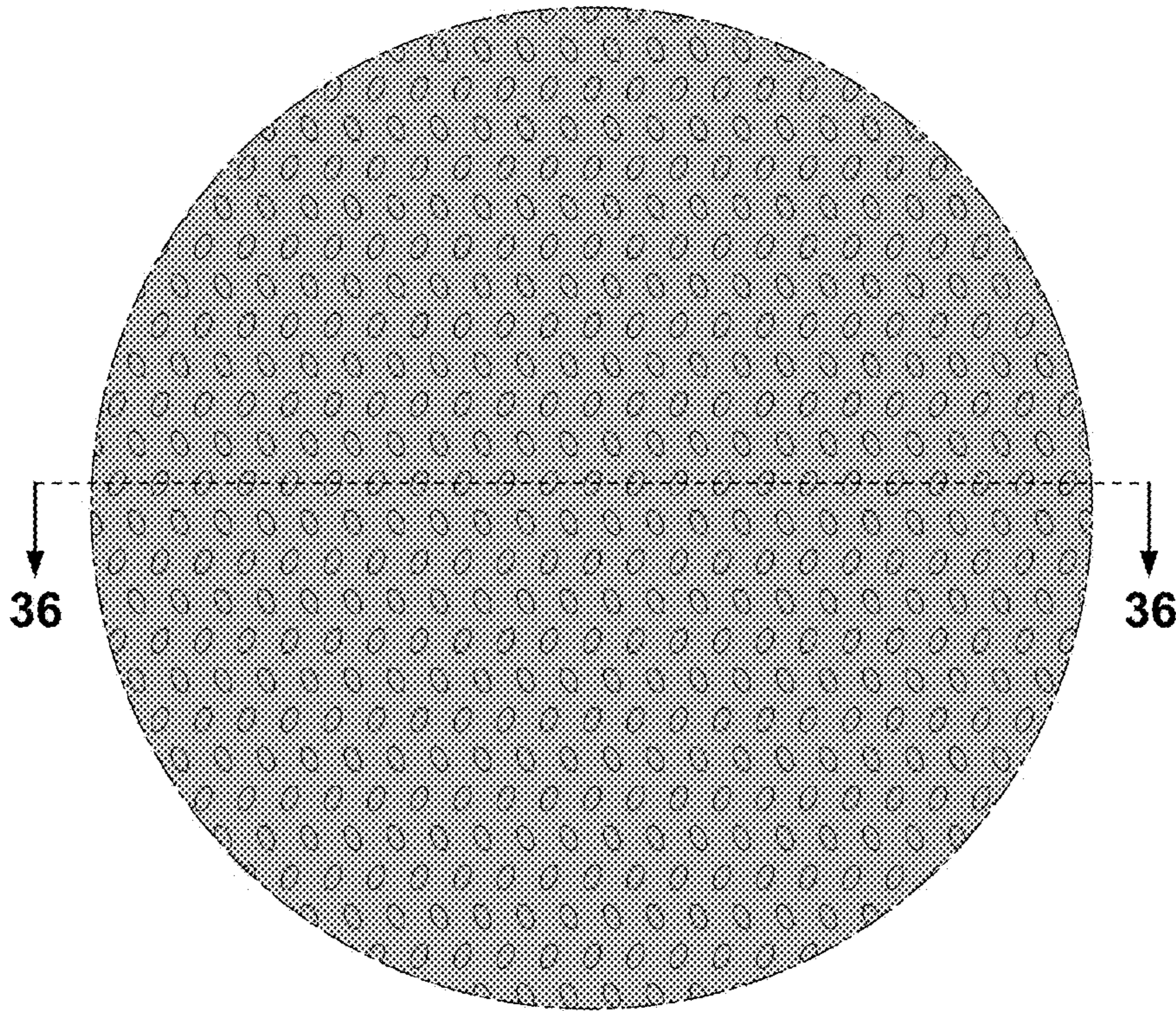

FIG. 35

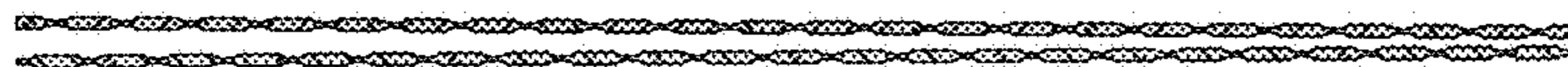

FIG. 36

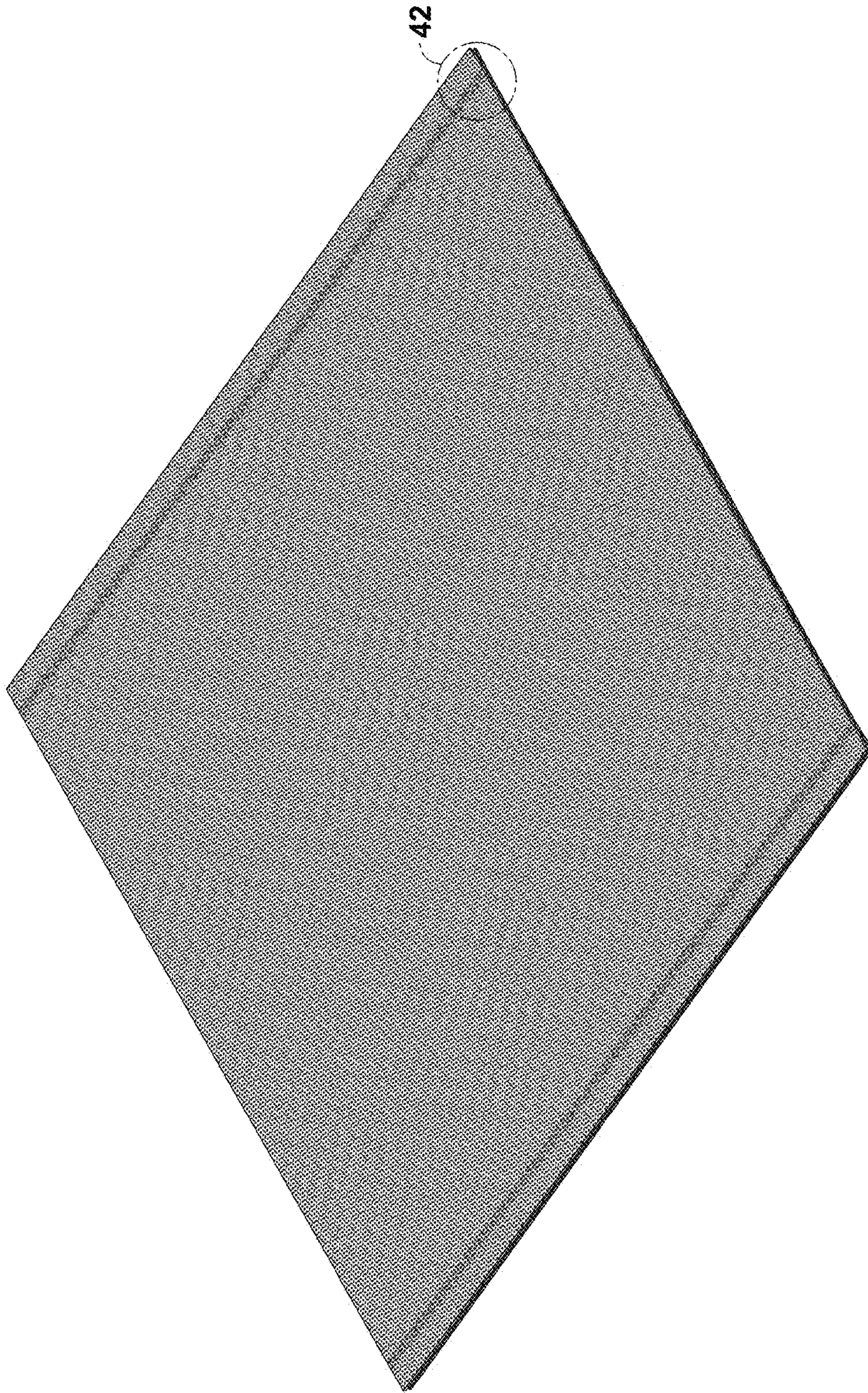

FIG. 37

---

FIG. 38

---

FIG. 39

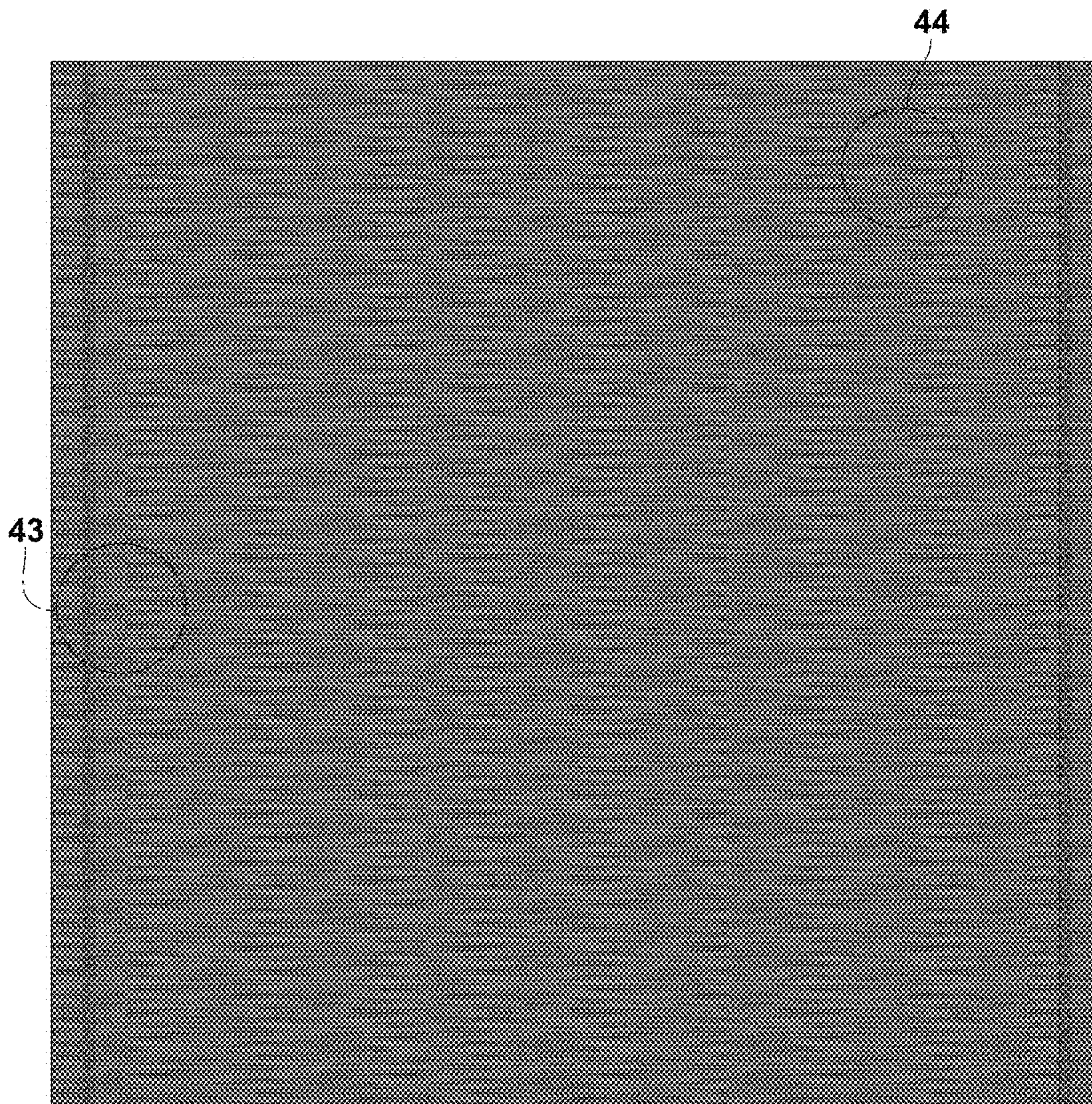

FIG. 40

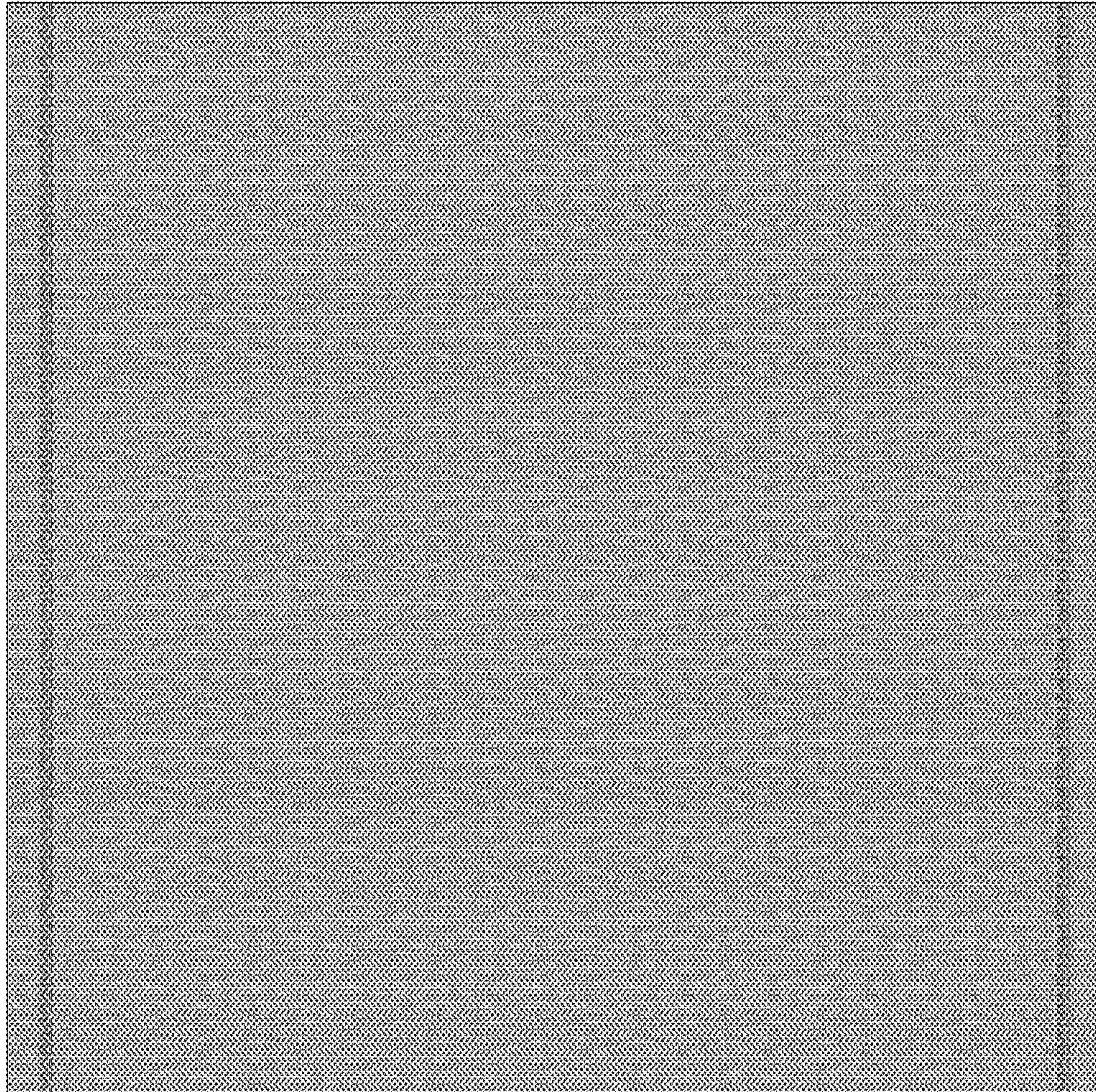

FIG. 41

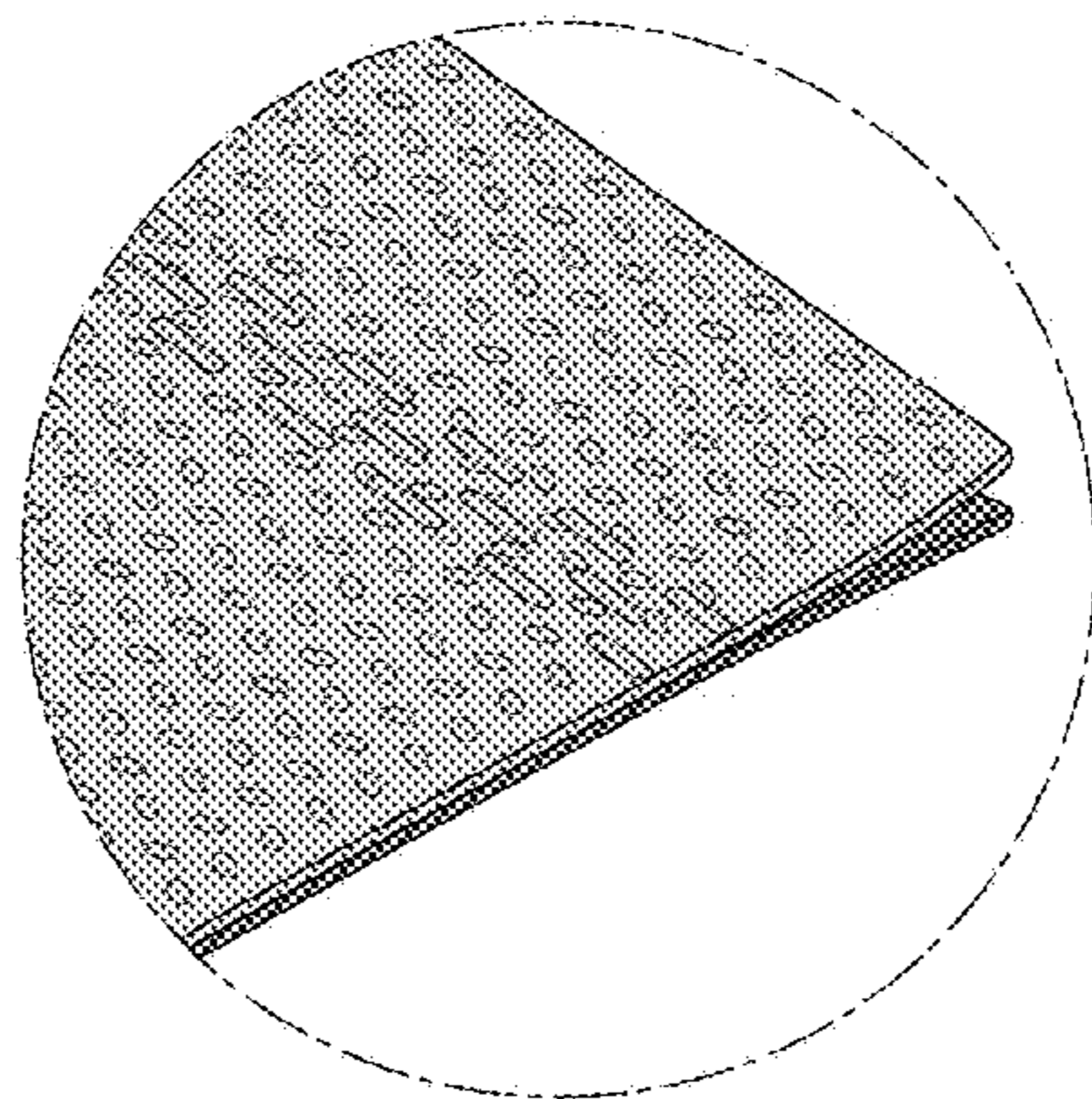

FIG. 42

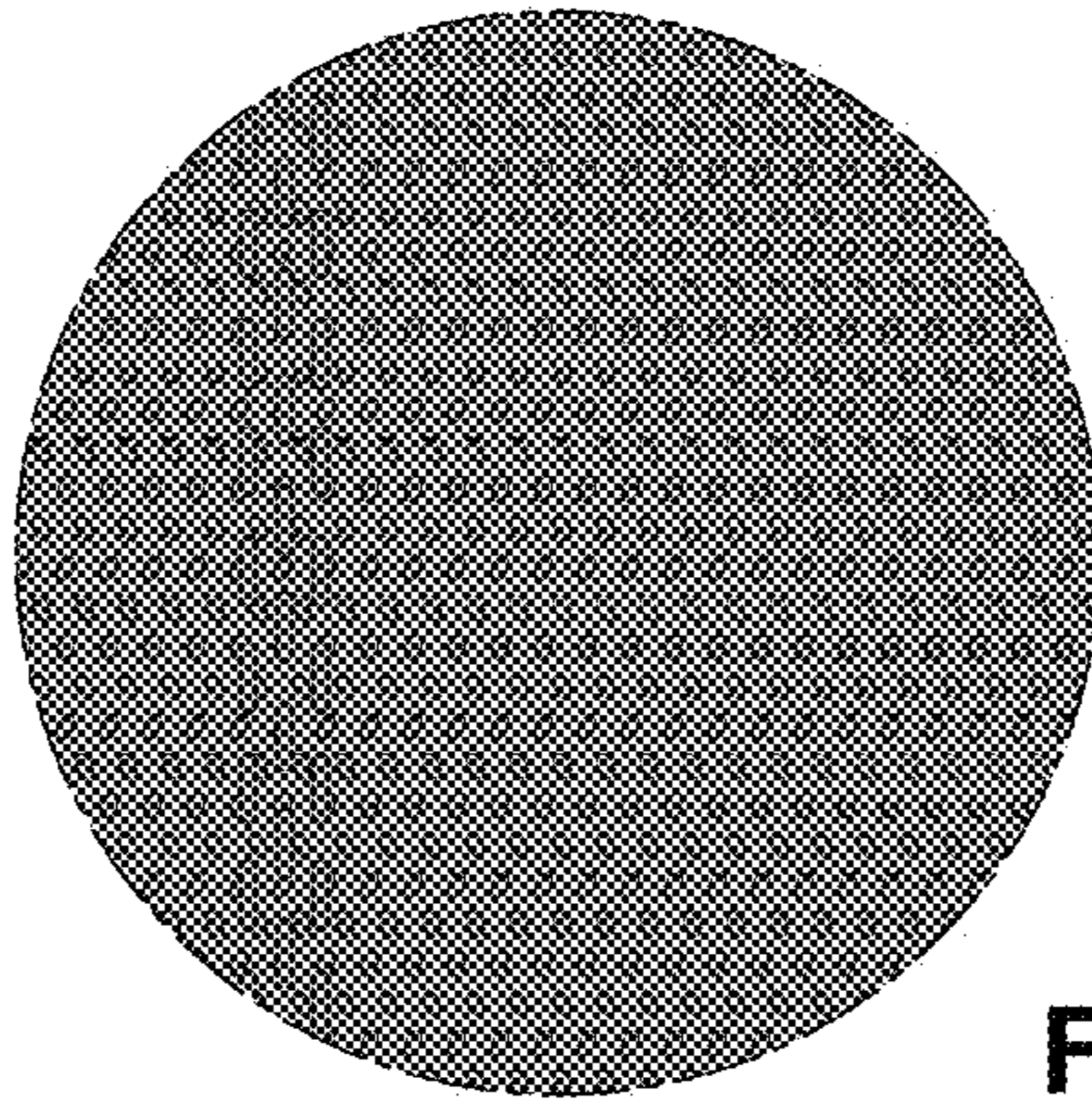

FIG. 43

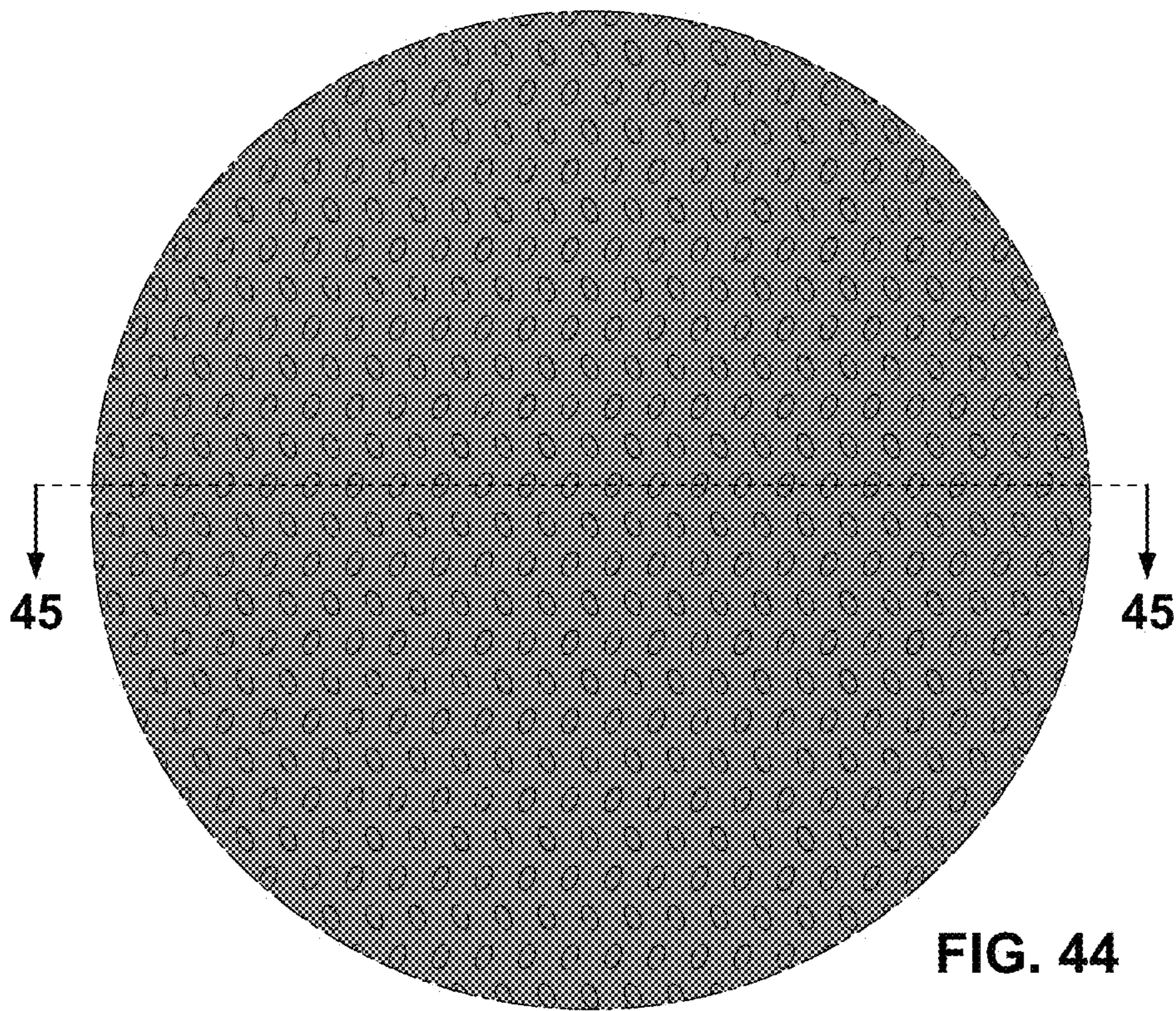

FIG. 44

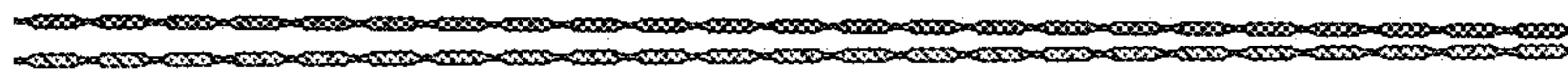

FIG. 45

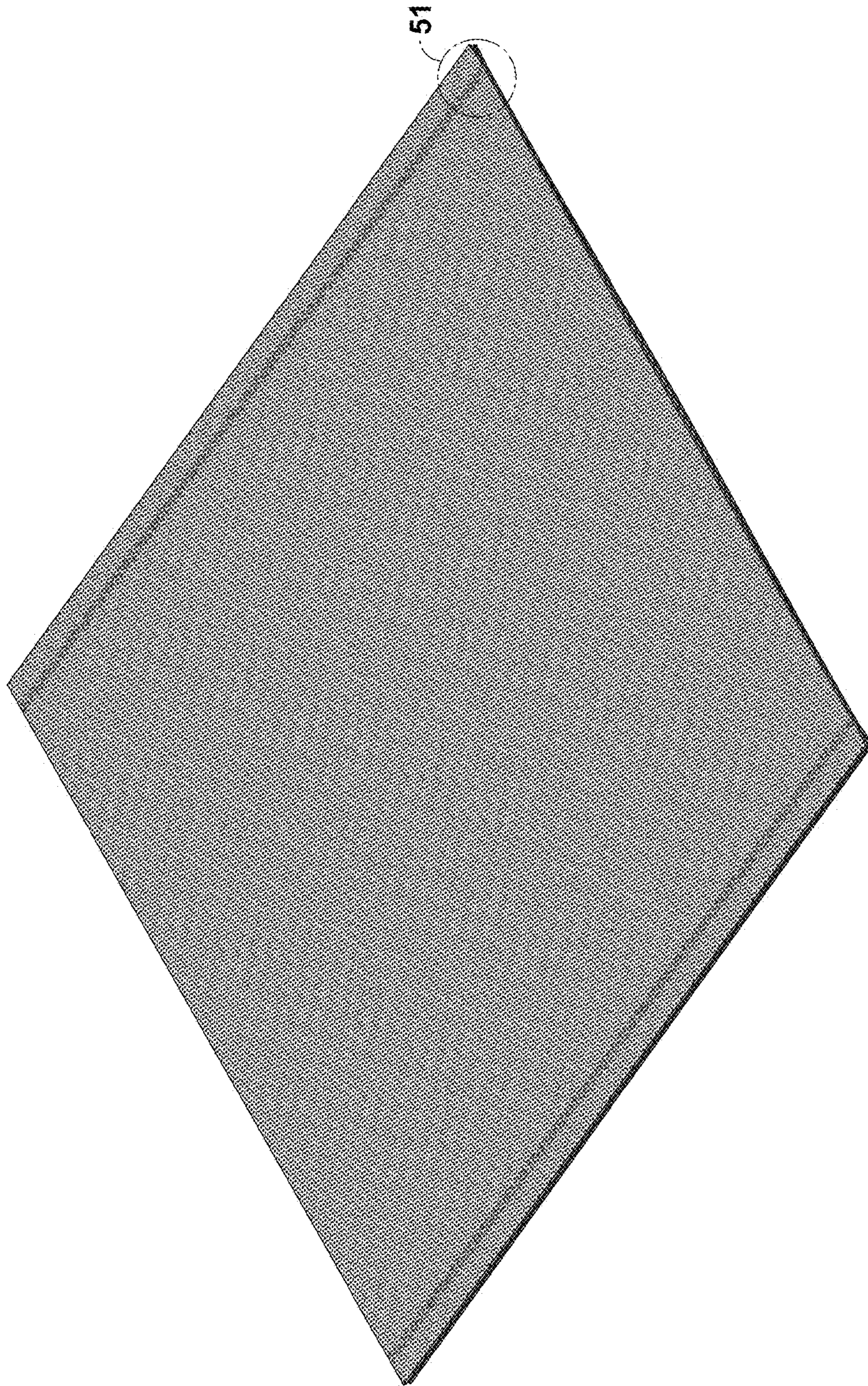

FIG. 46



---

FIG. 47

---

FIG. 48

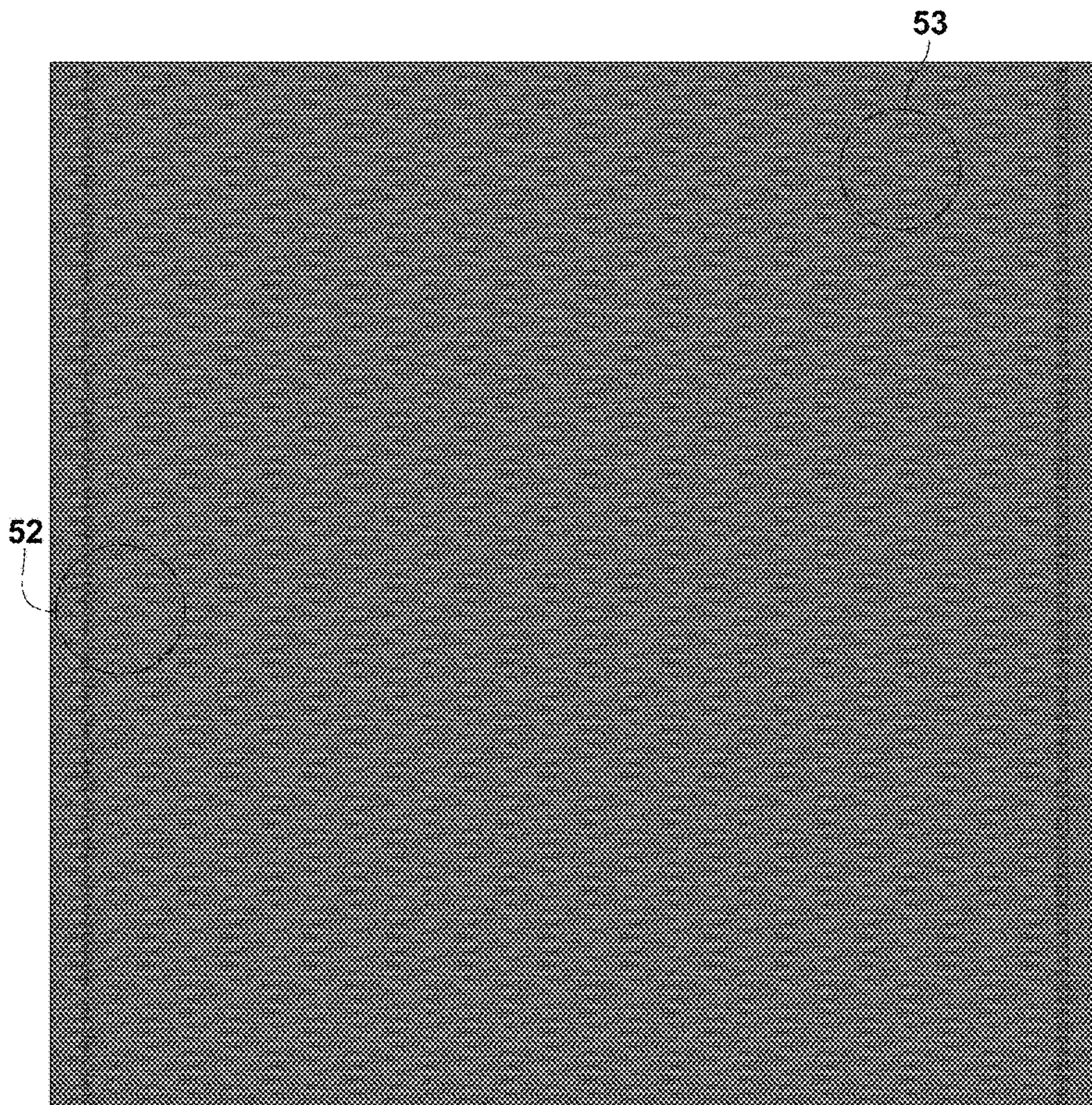

FIG. 49

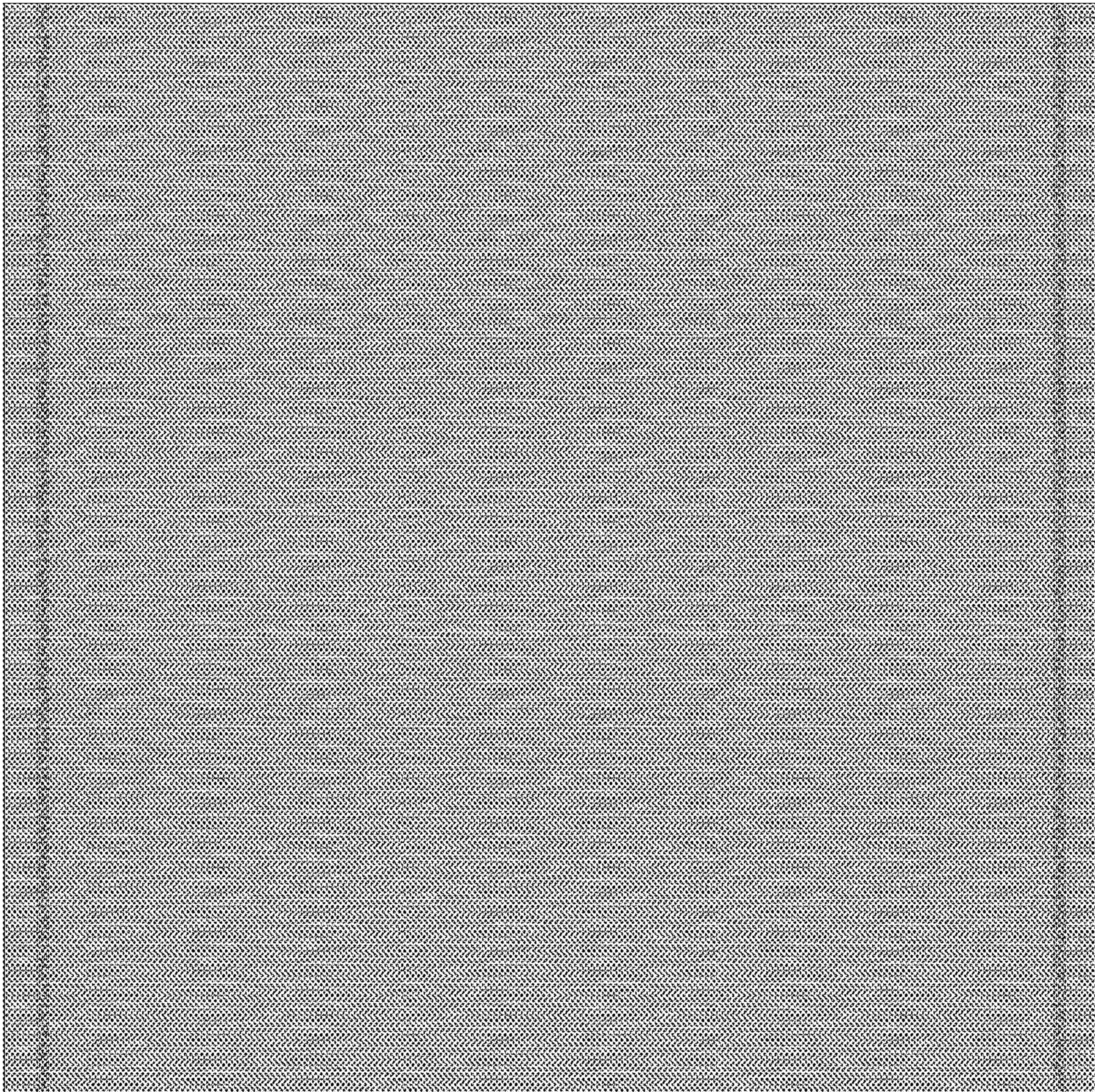

FIG. 50

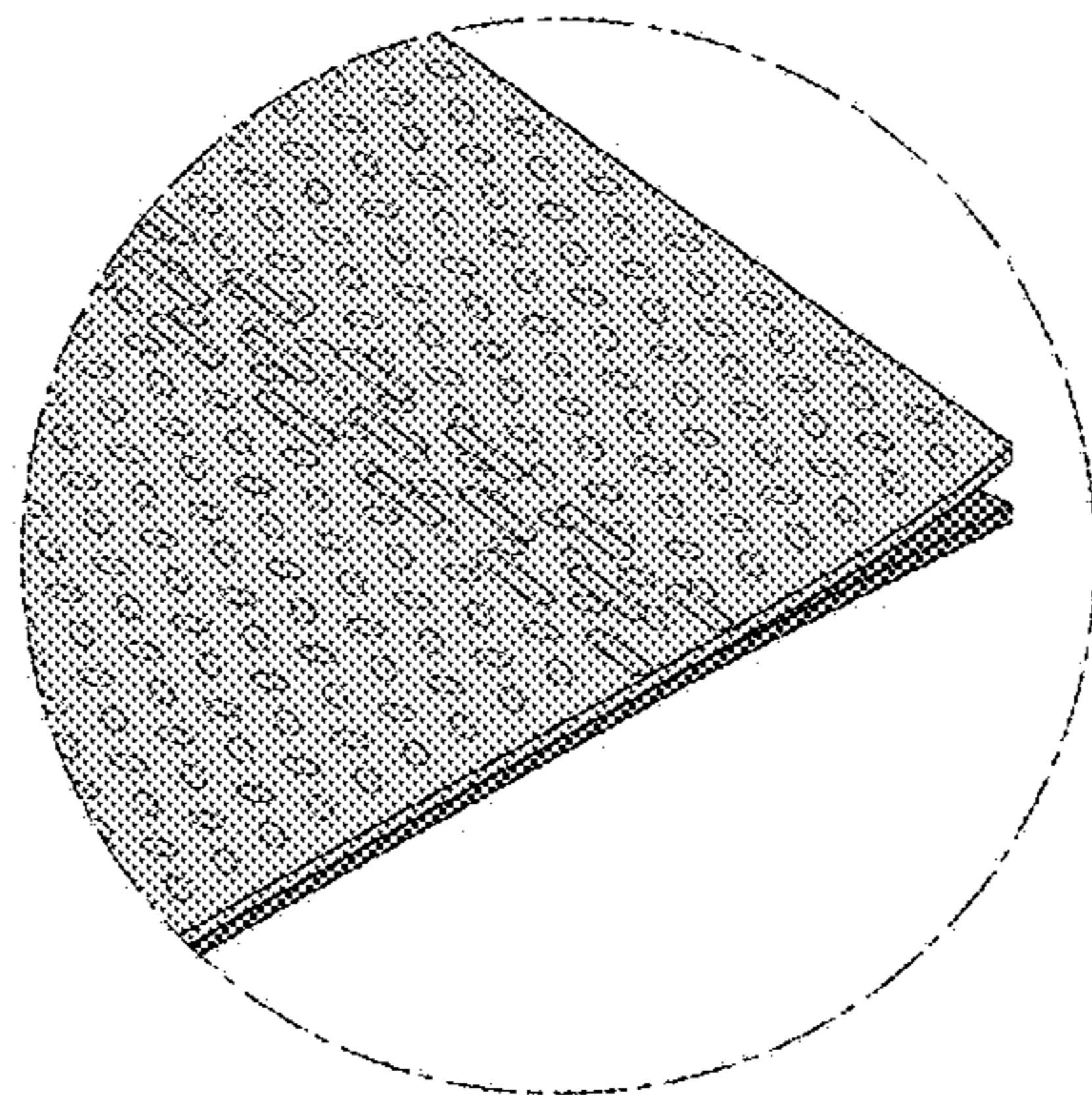

FIG. 51

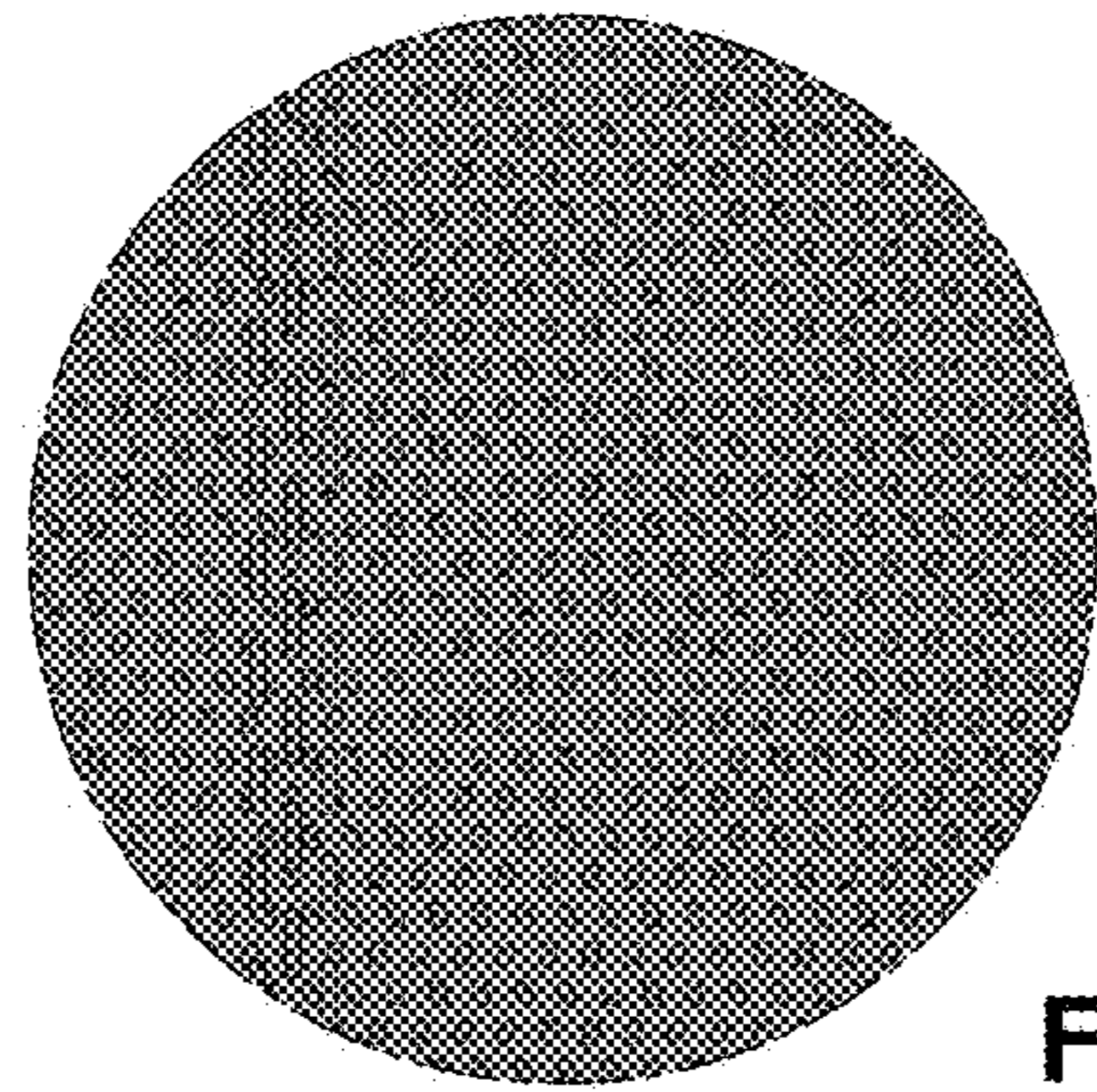

FIG. 52

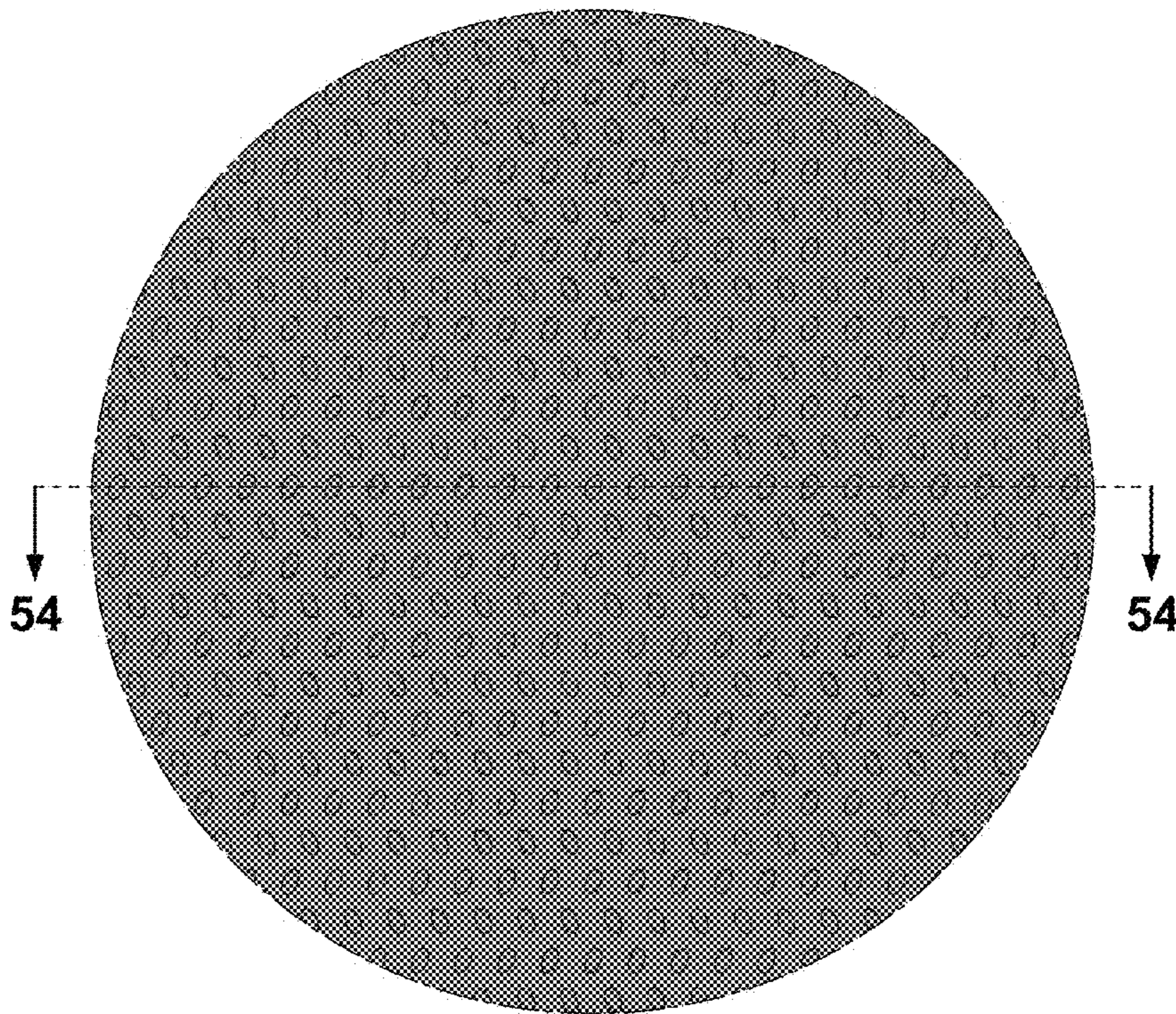

FIG. 53

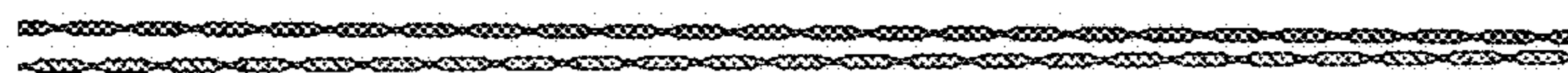

FIG. 54

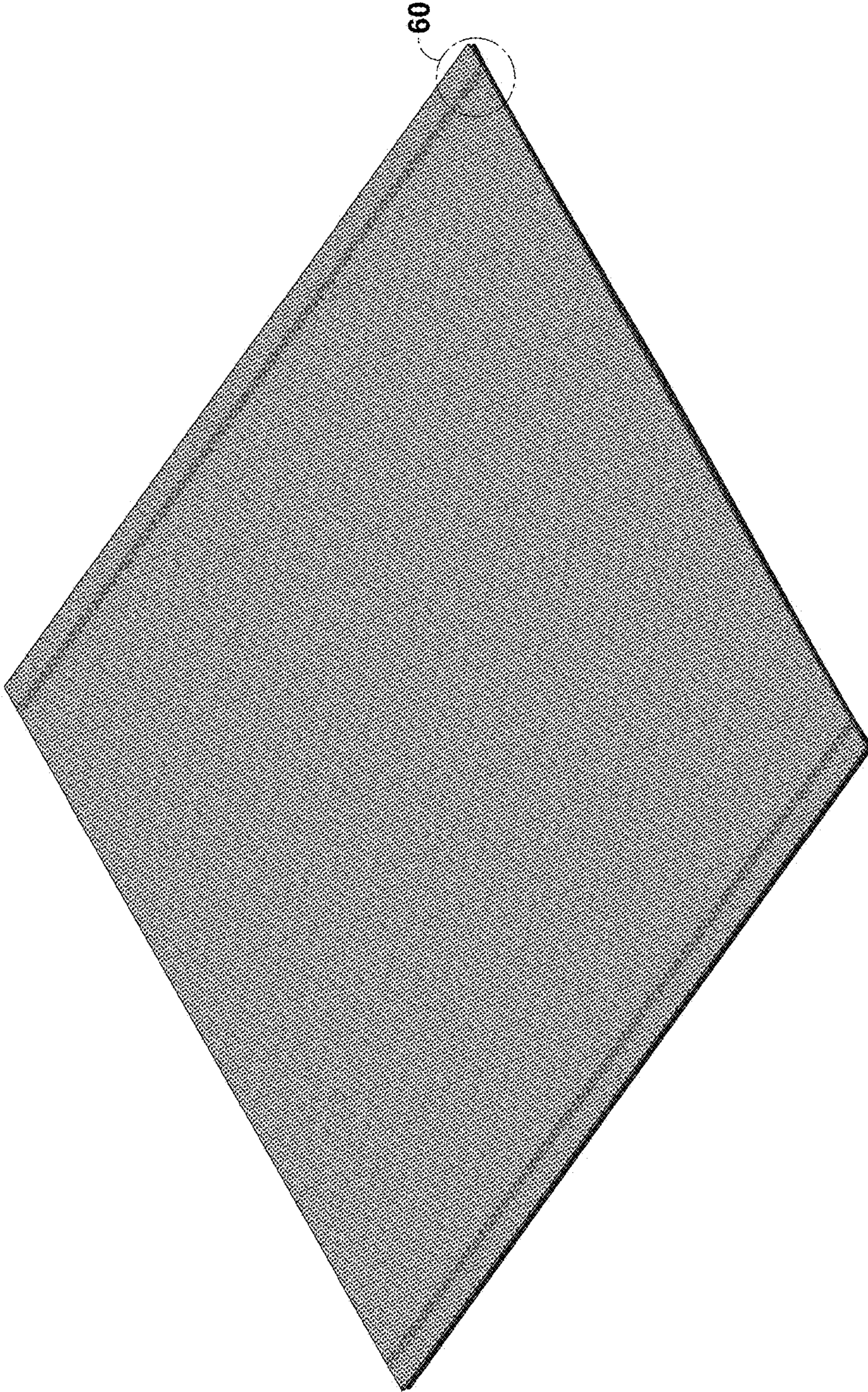

FIG. 55

---

FIG. 56

---

FIG. 57

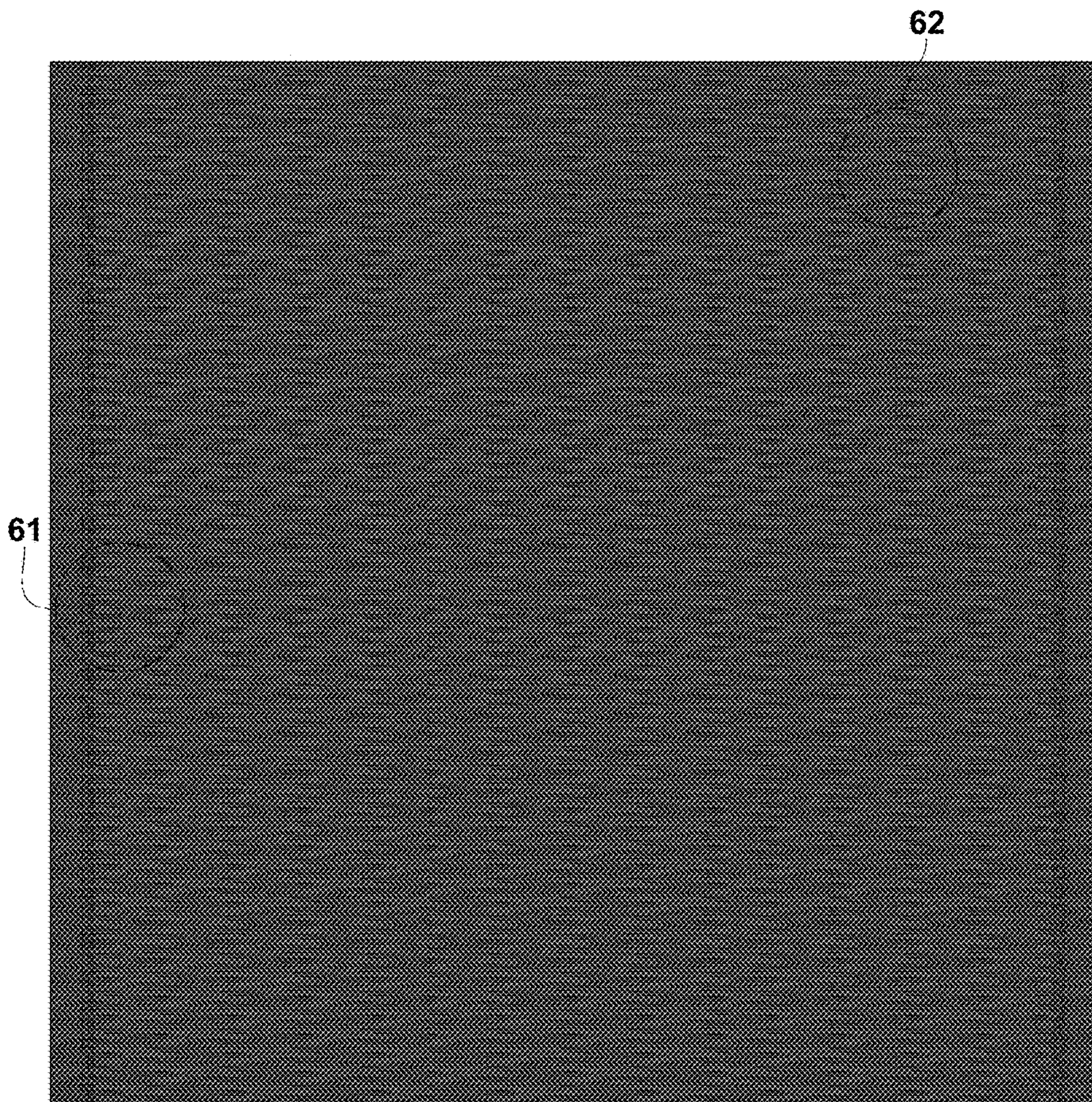

FIG. 58

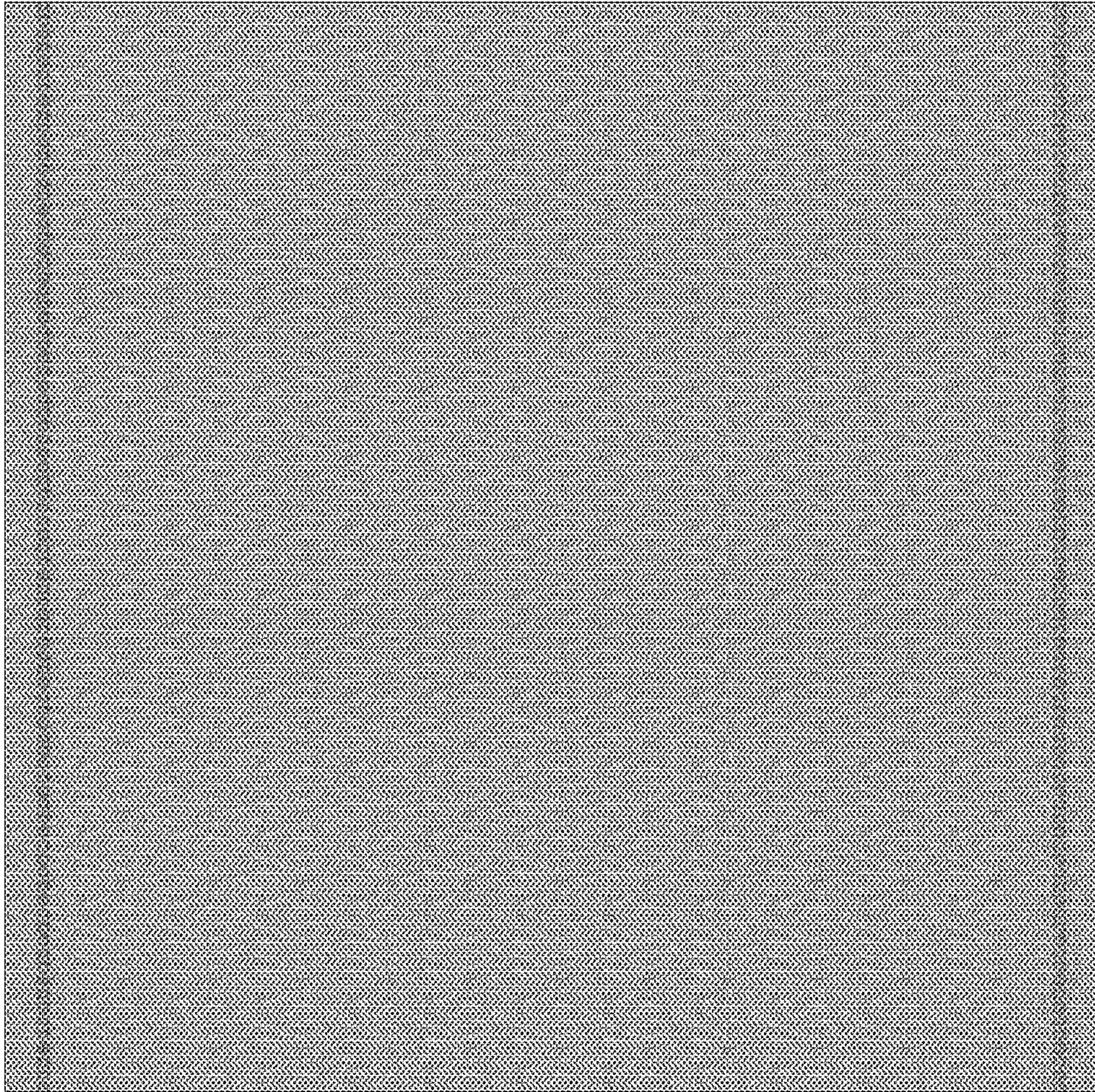

FIG. 59

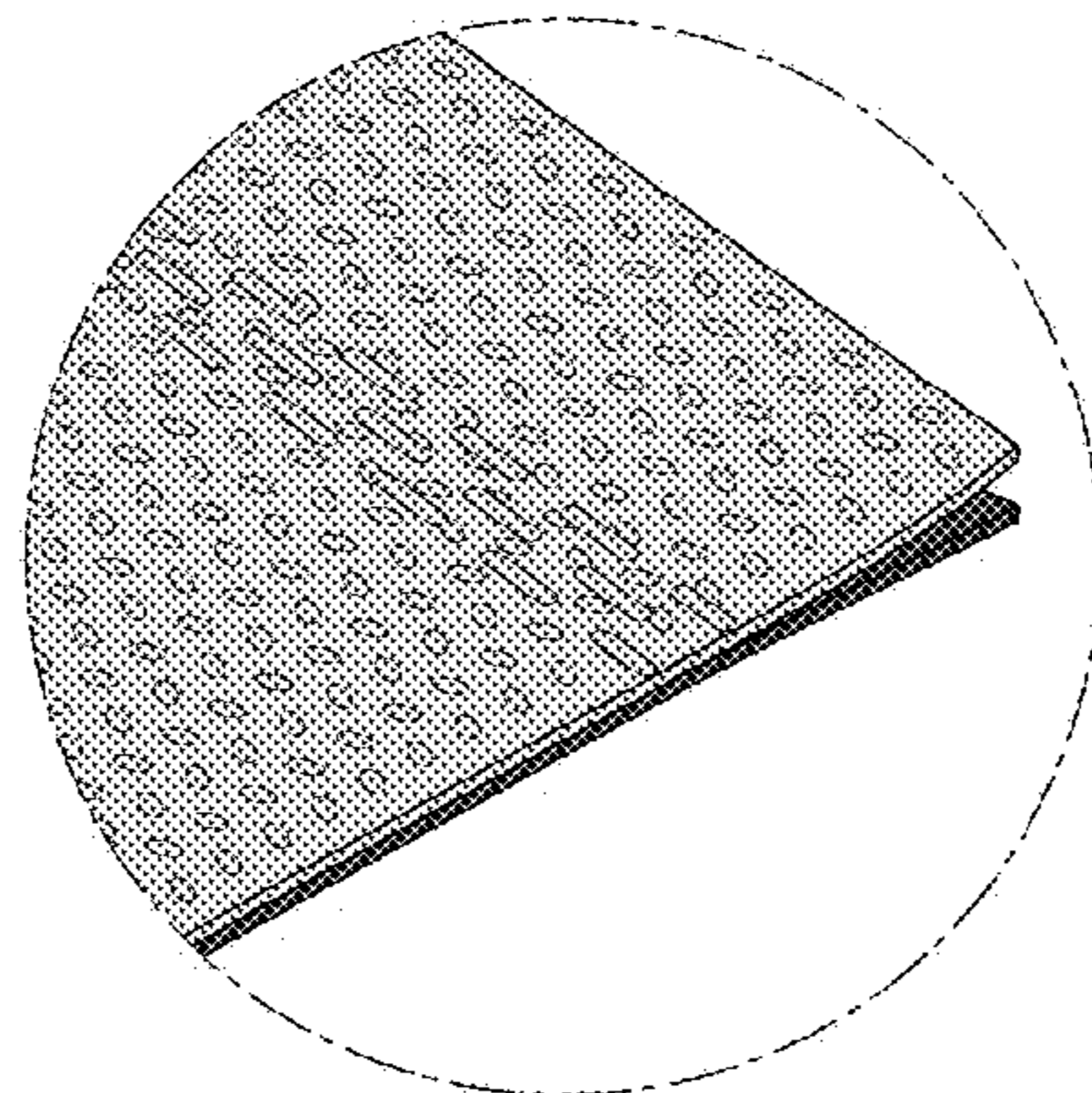

FIG. 60

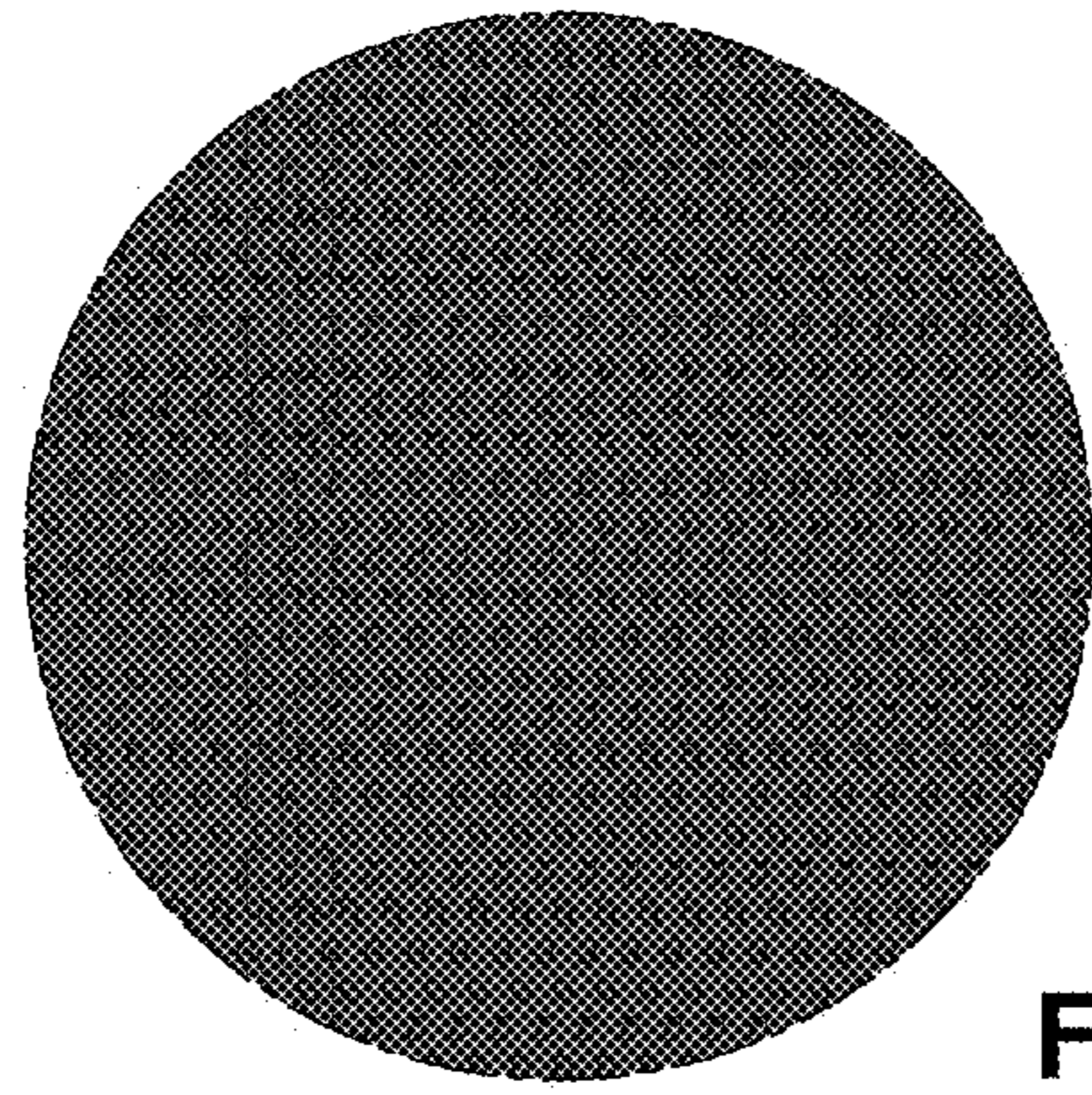

FIG. 61

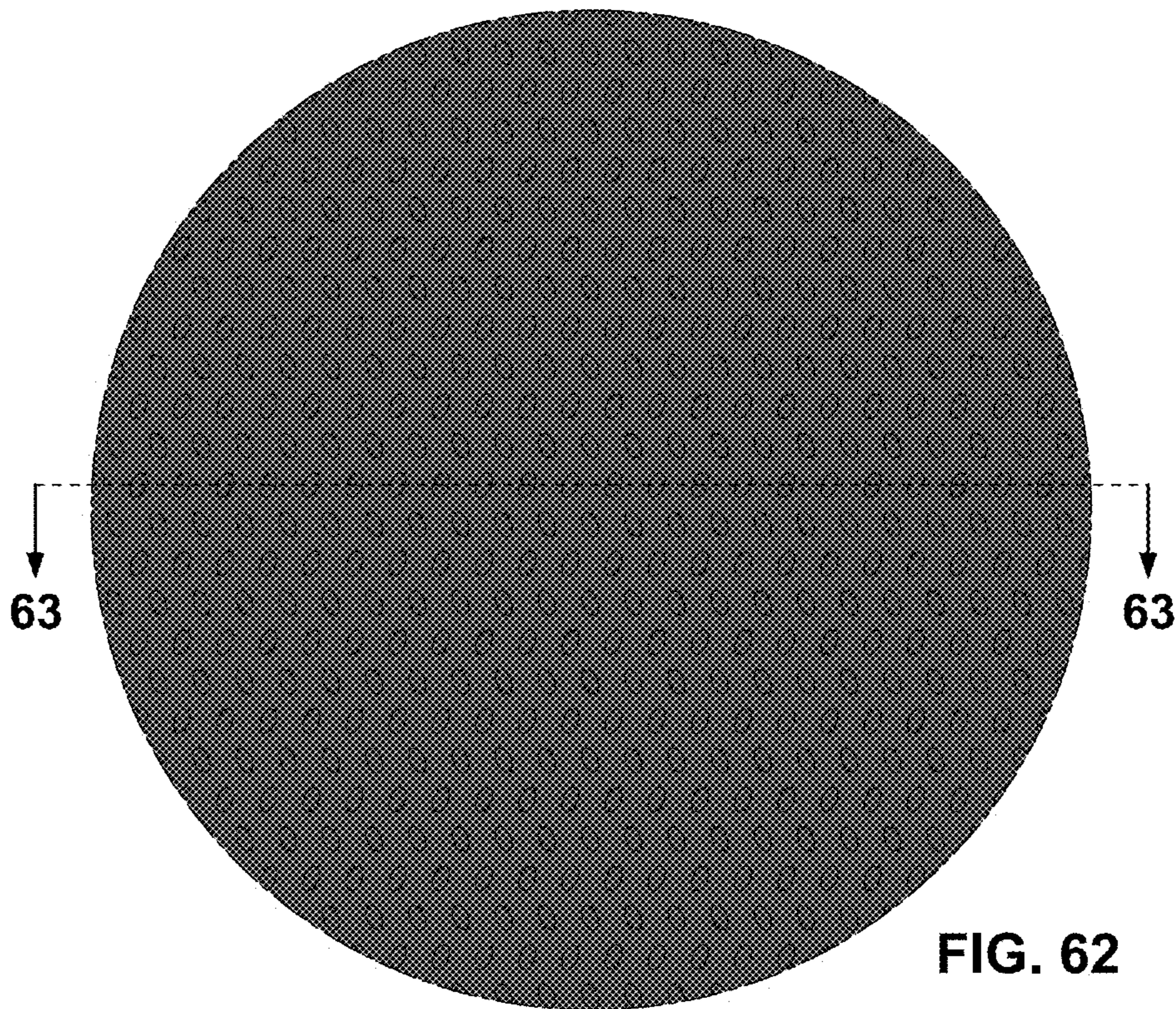

FIG. 62

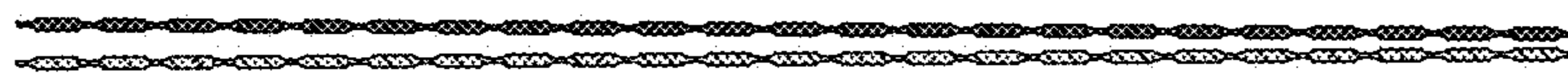

FIG. 63

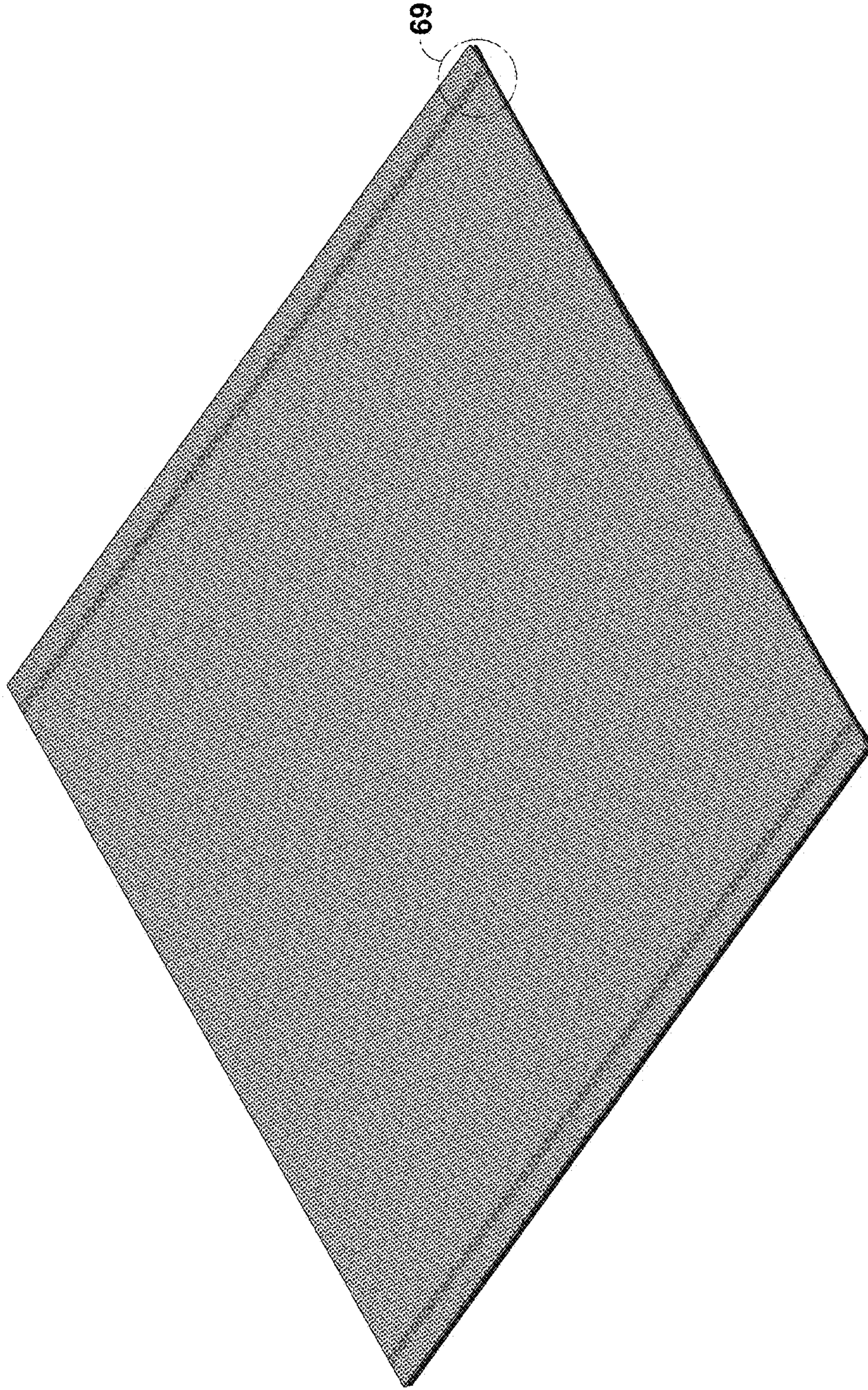

FIG. 64



---

FIG. 65

---

FIG. 66

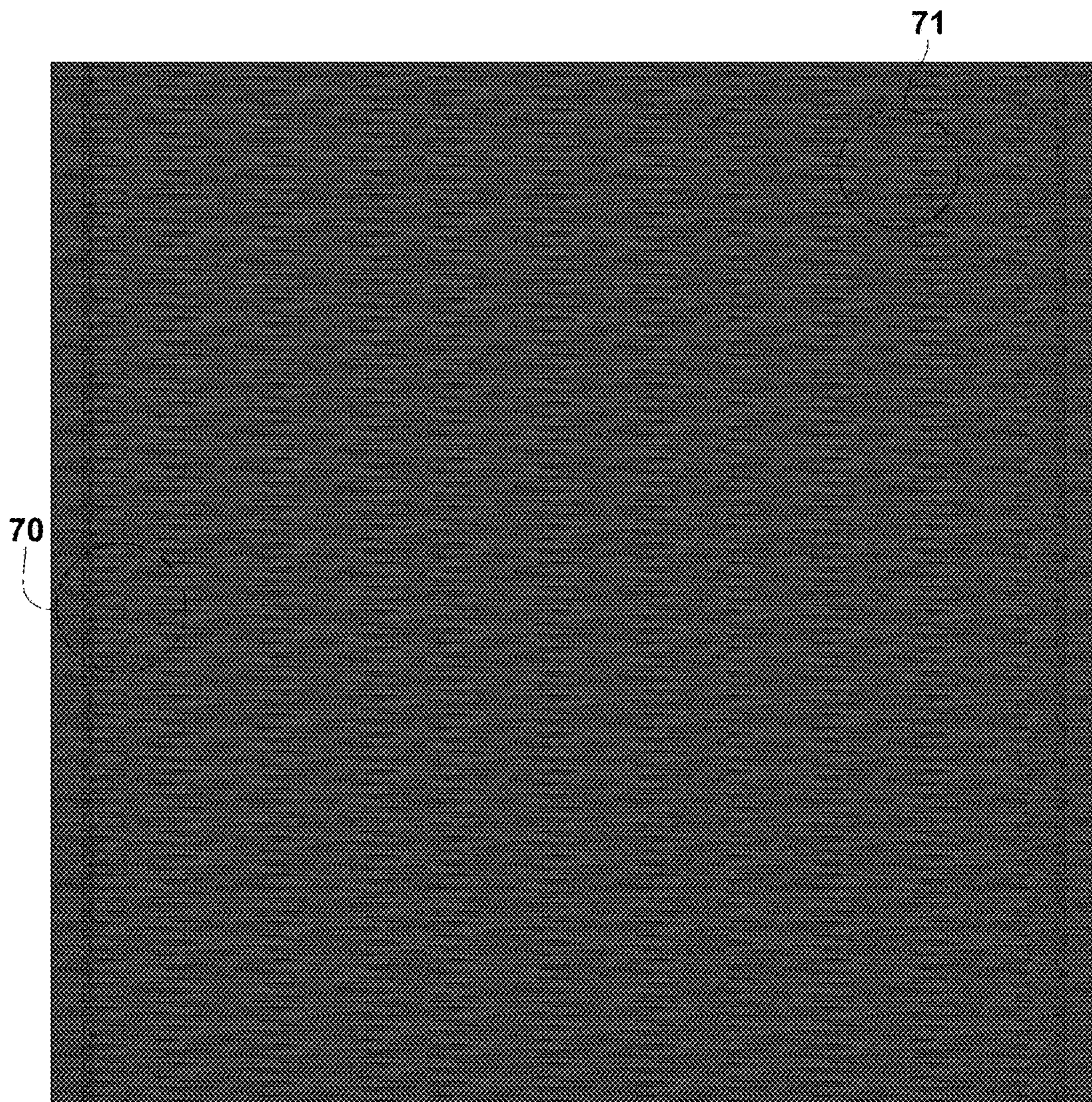

FIG. 67

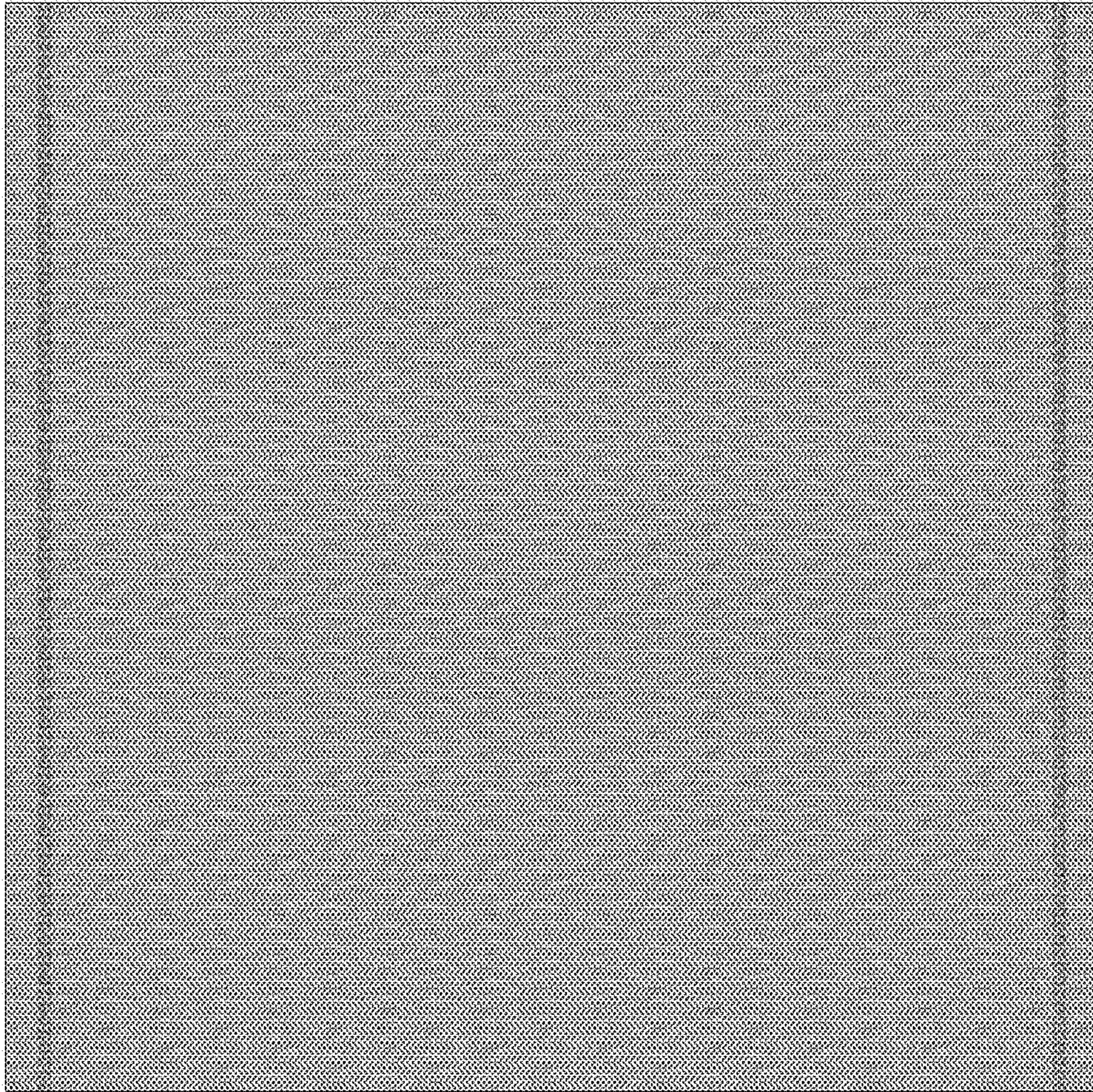

FIG. 68

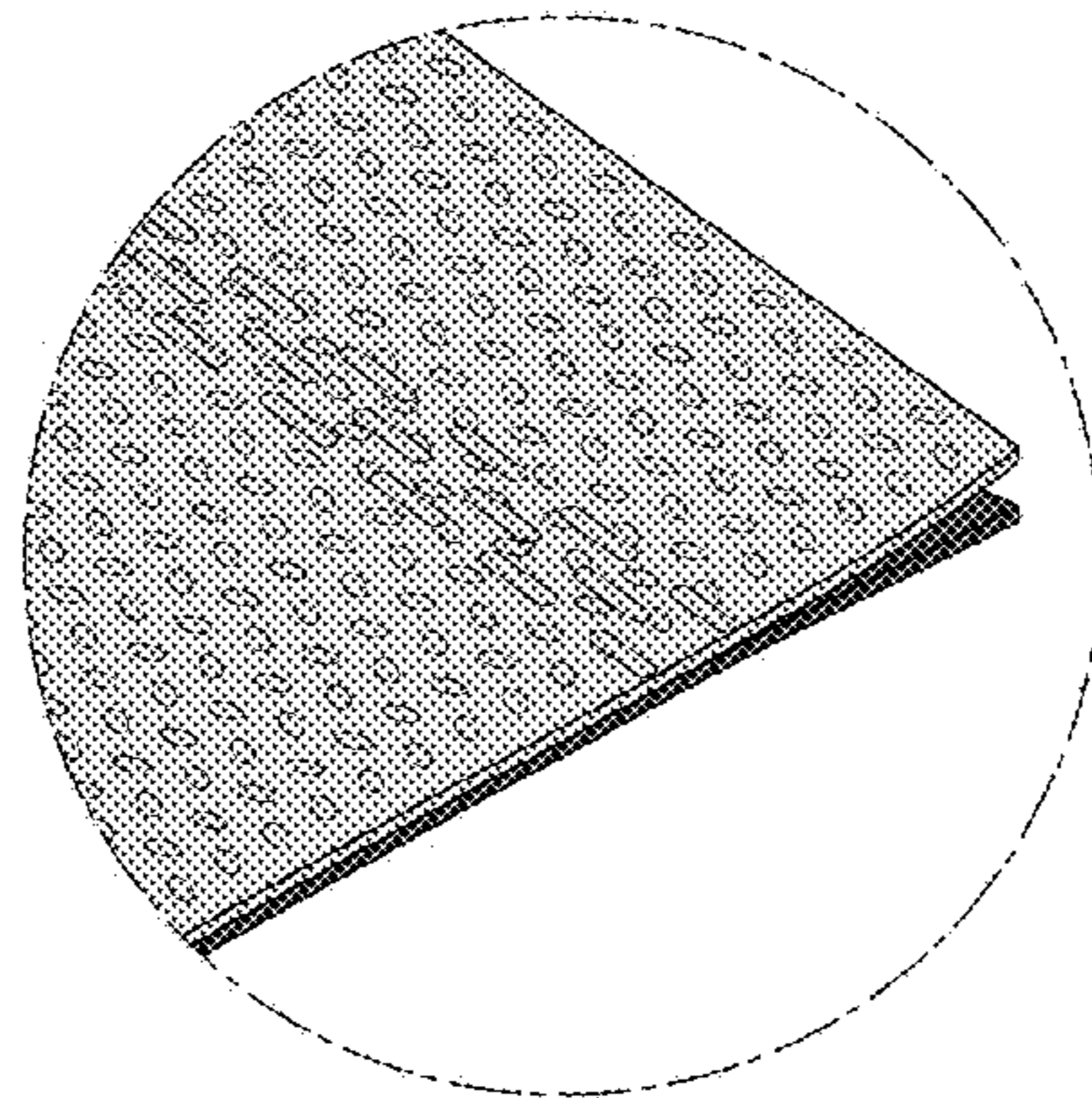

FIG. 69

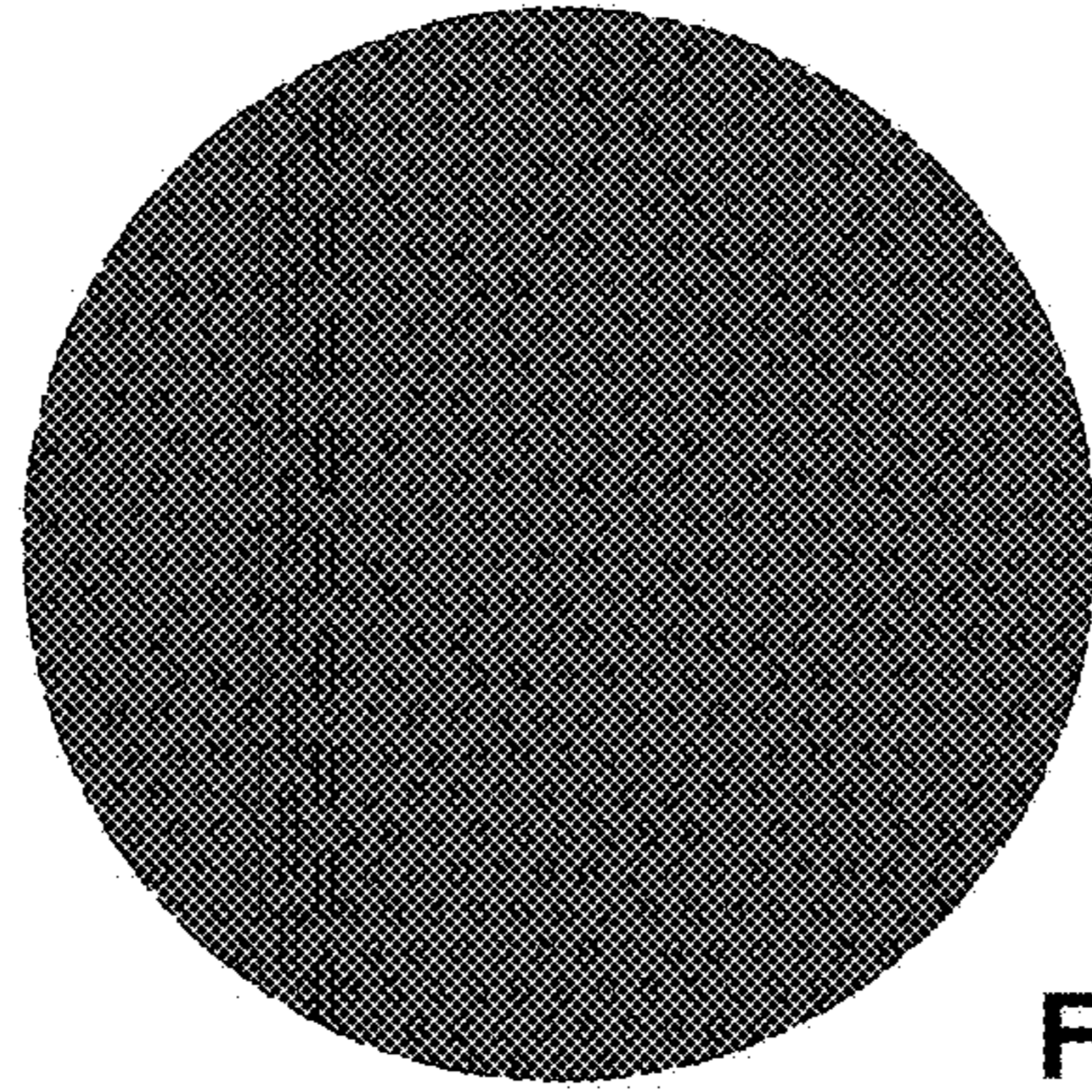

FIG. 70

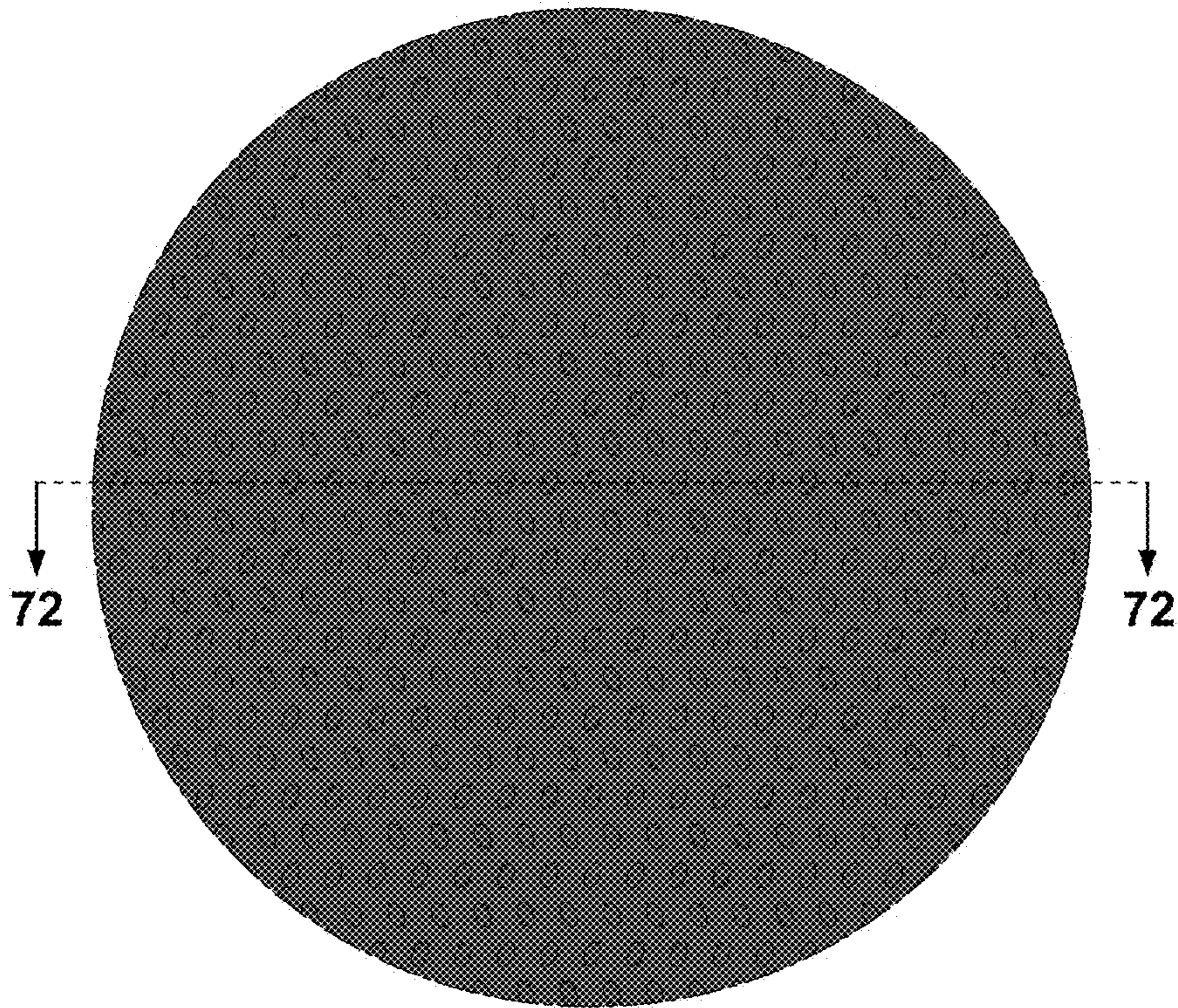

FIG. 71

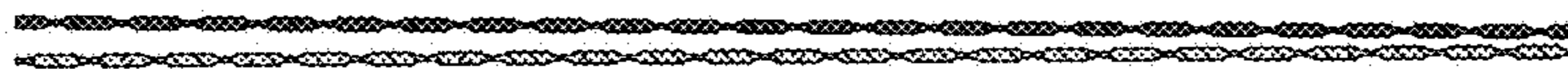

FIG. 72

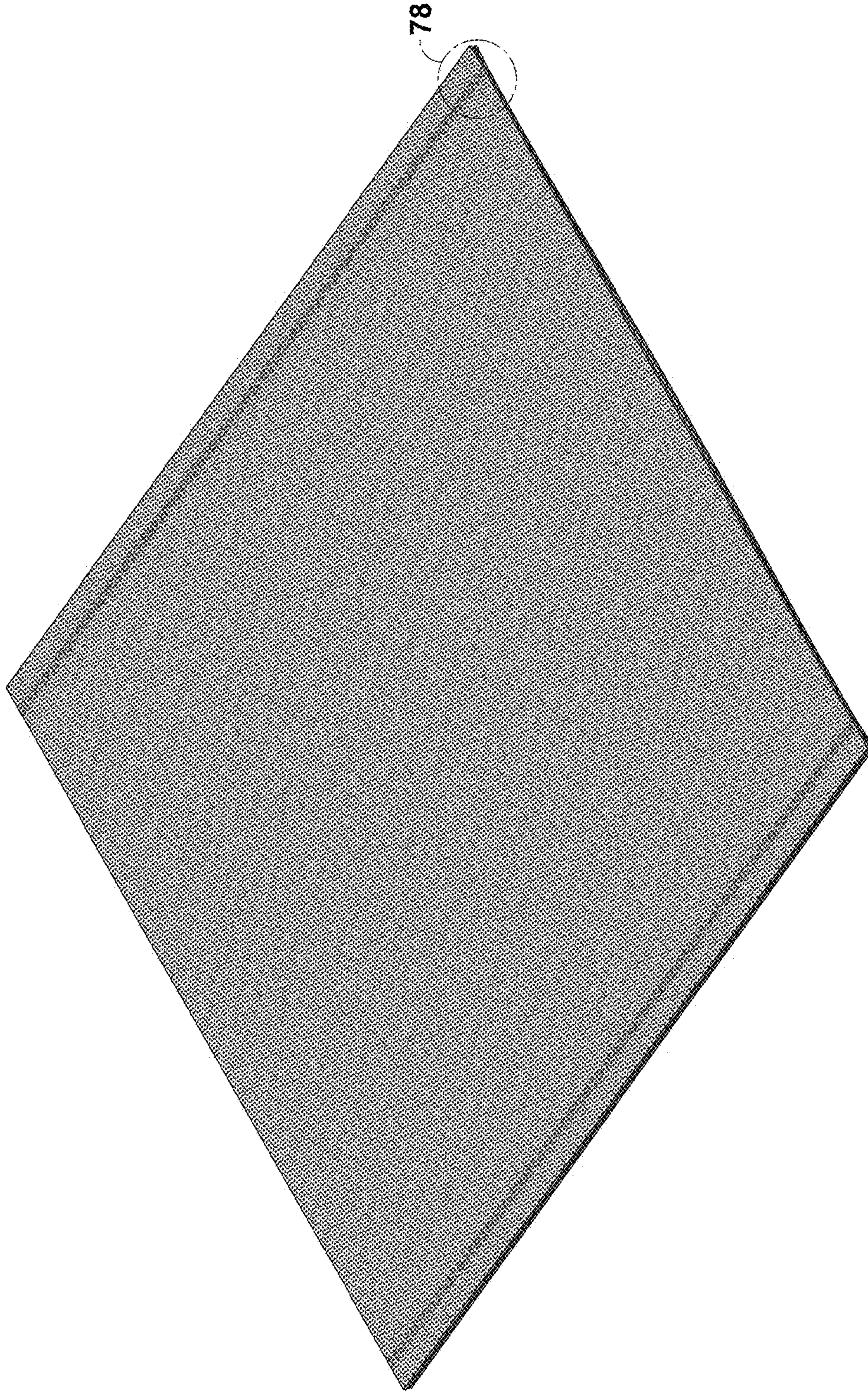

FIG. 73

---

---

FIG. 74

---

---

FIG. 75

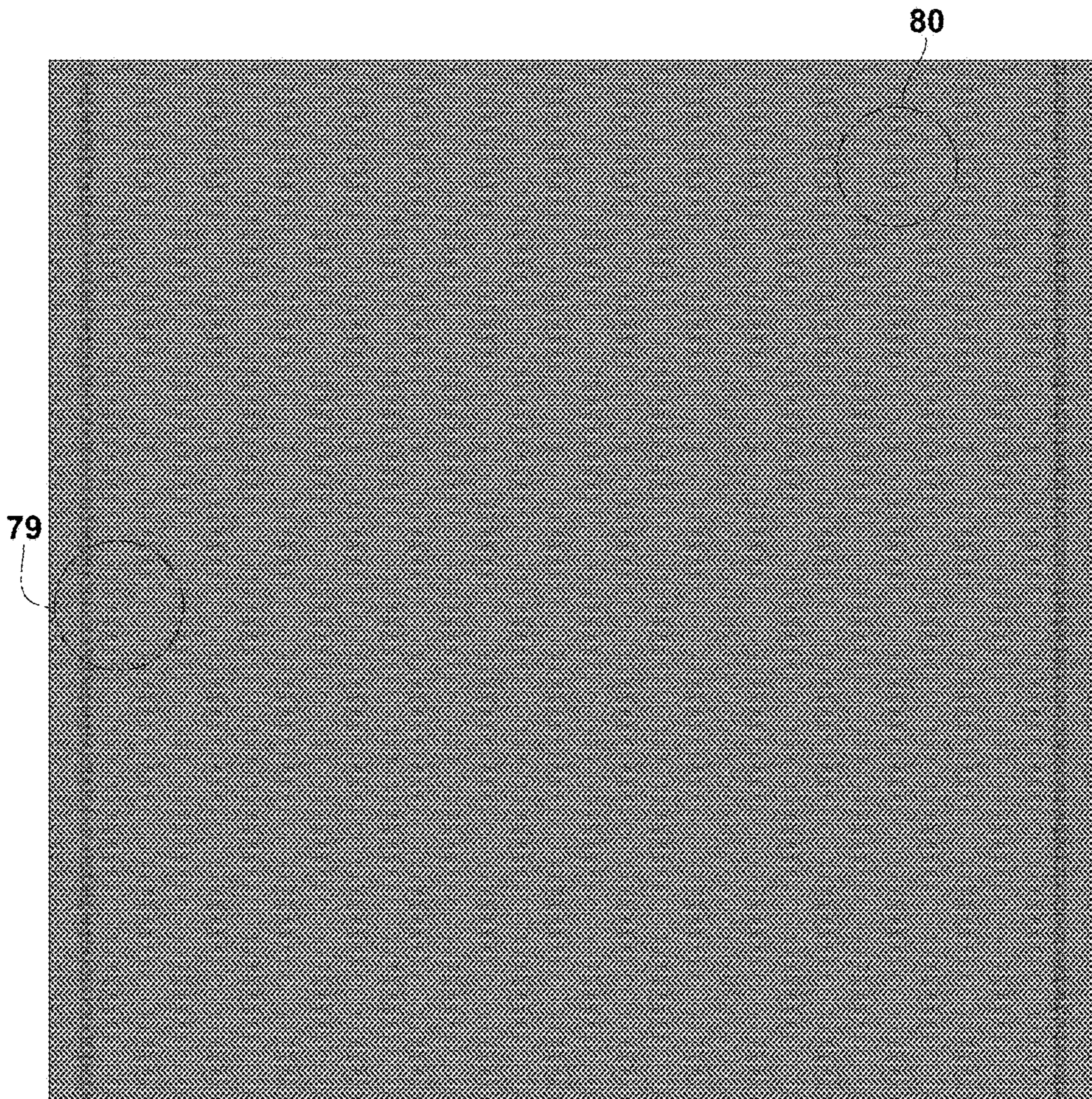

FIG. 76

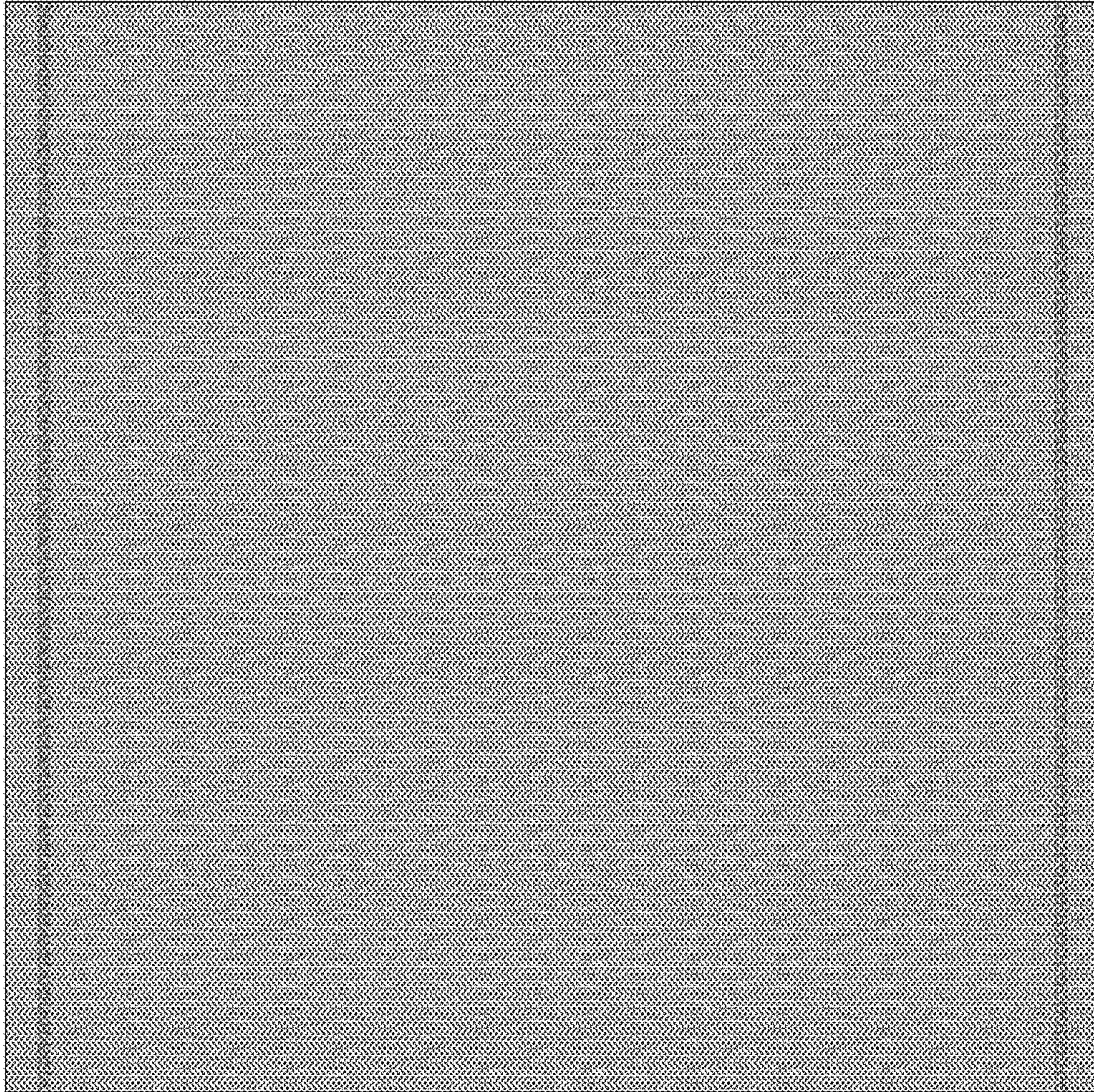

FIG. 77

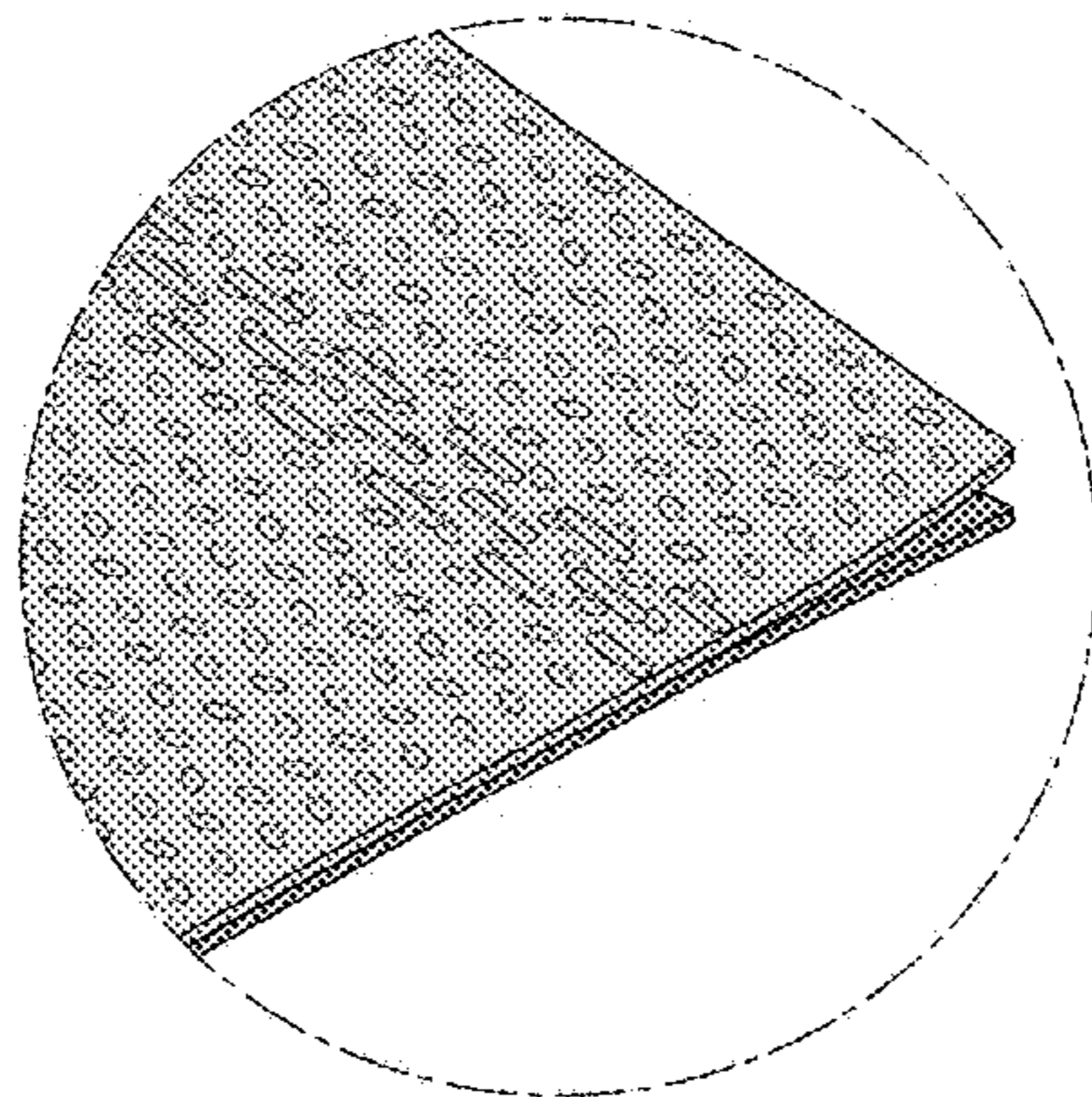

FIG. 78

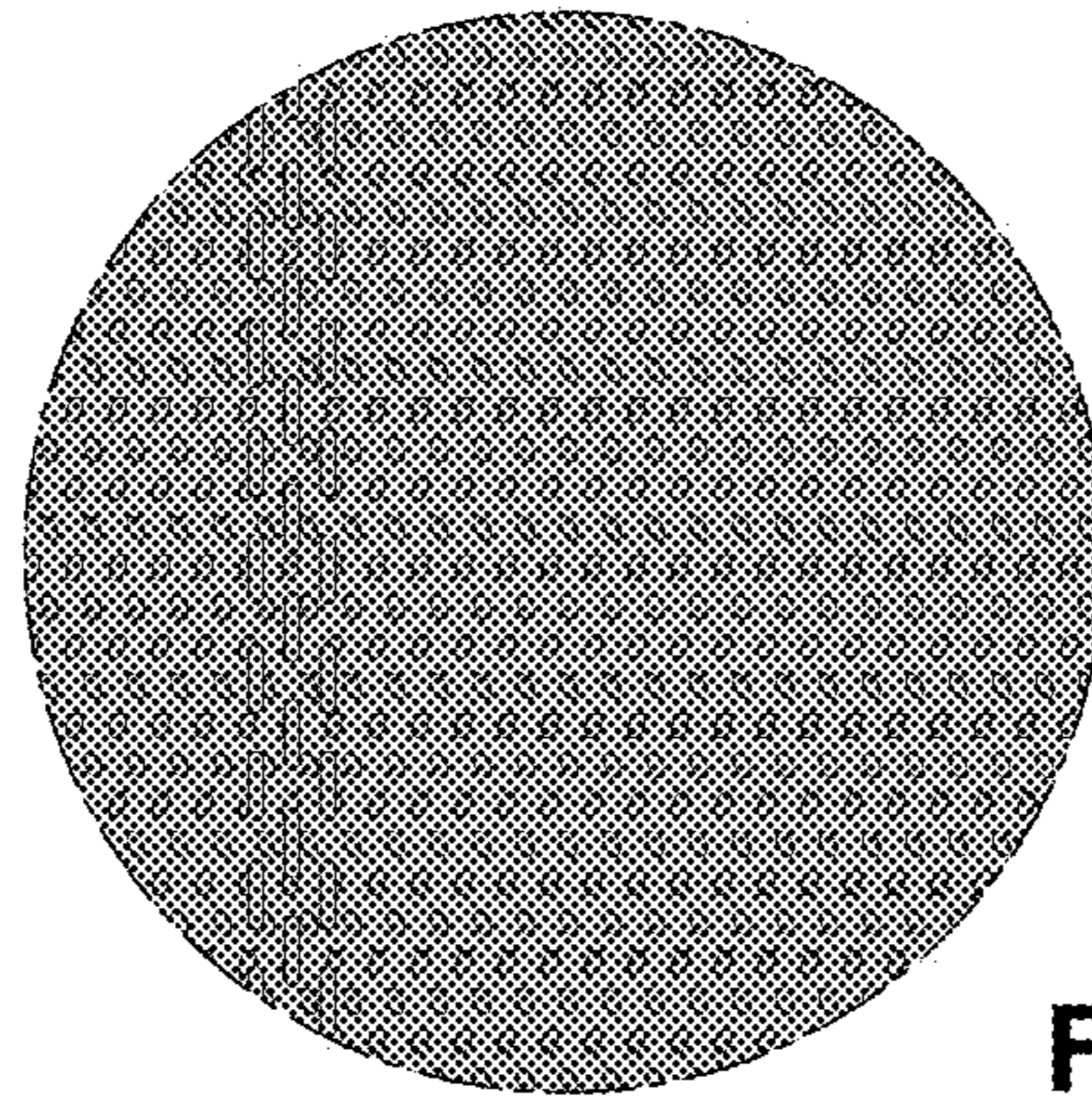

FIG. 79

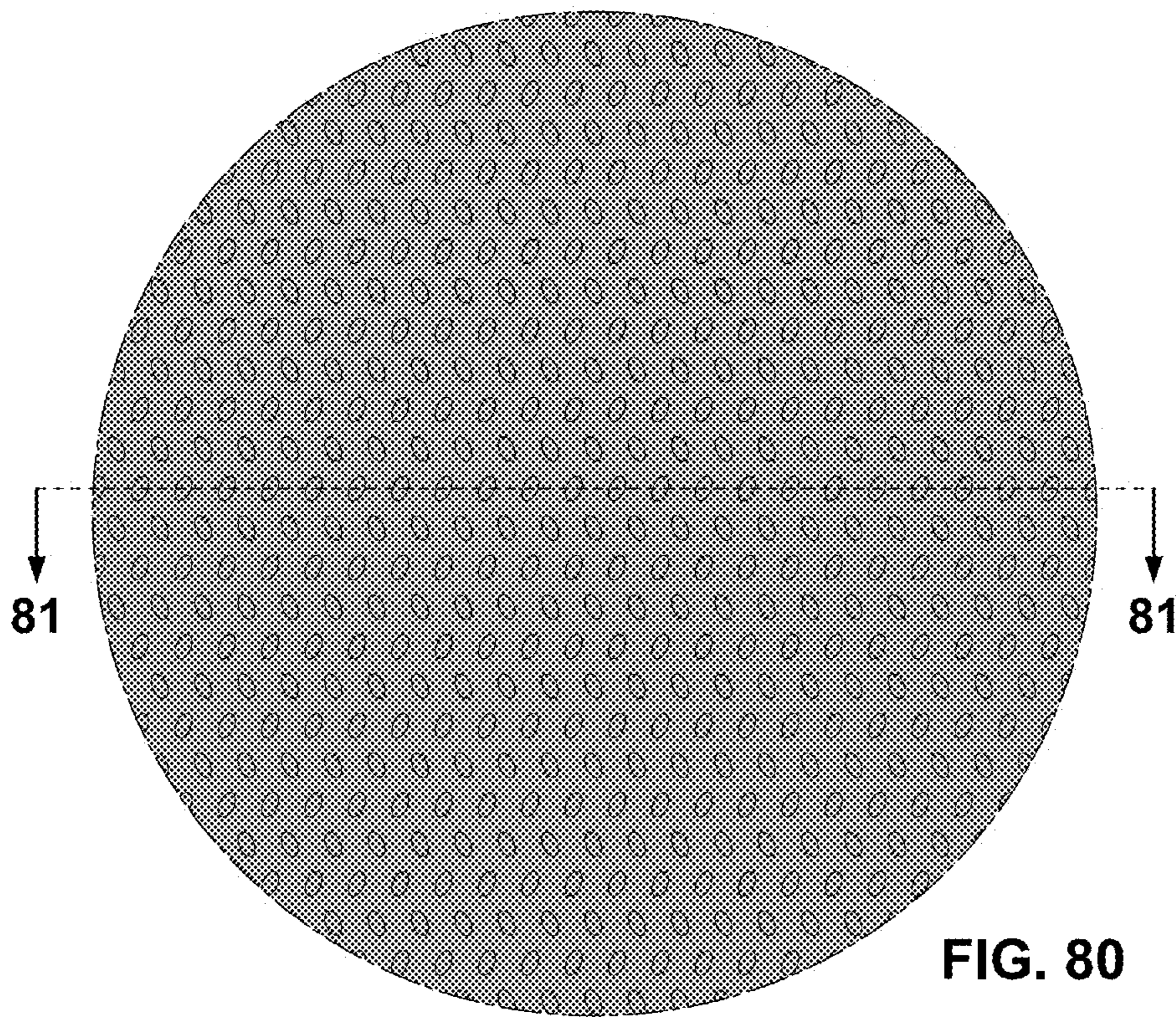

FIG. 80

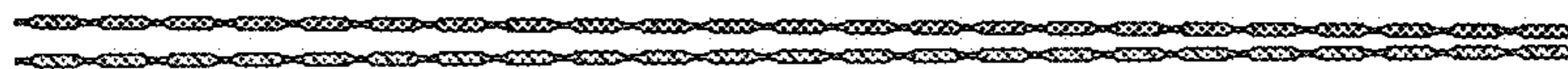

FIG. 81

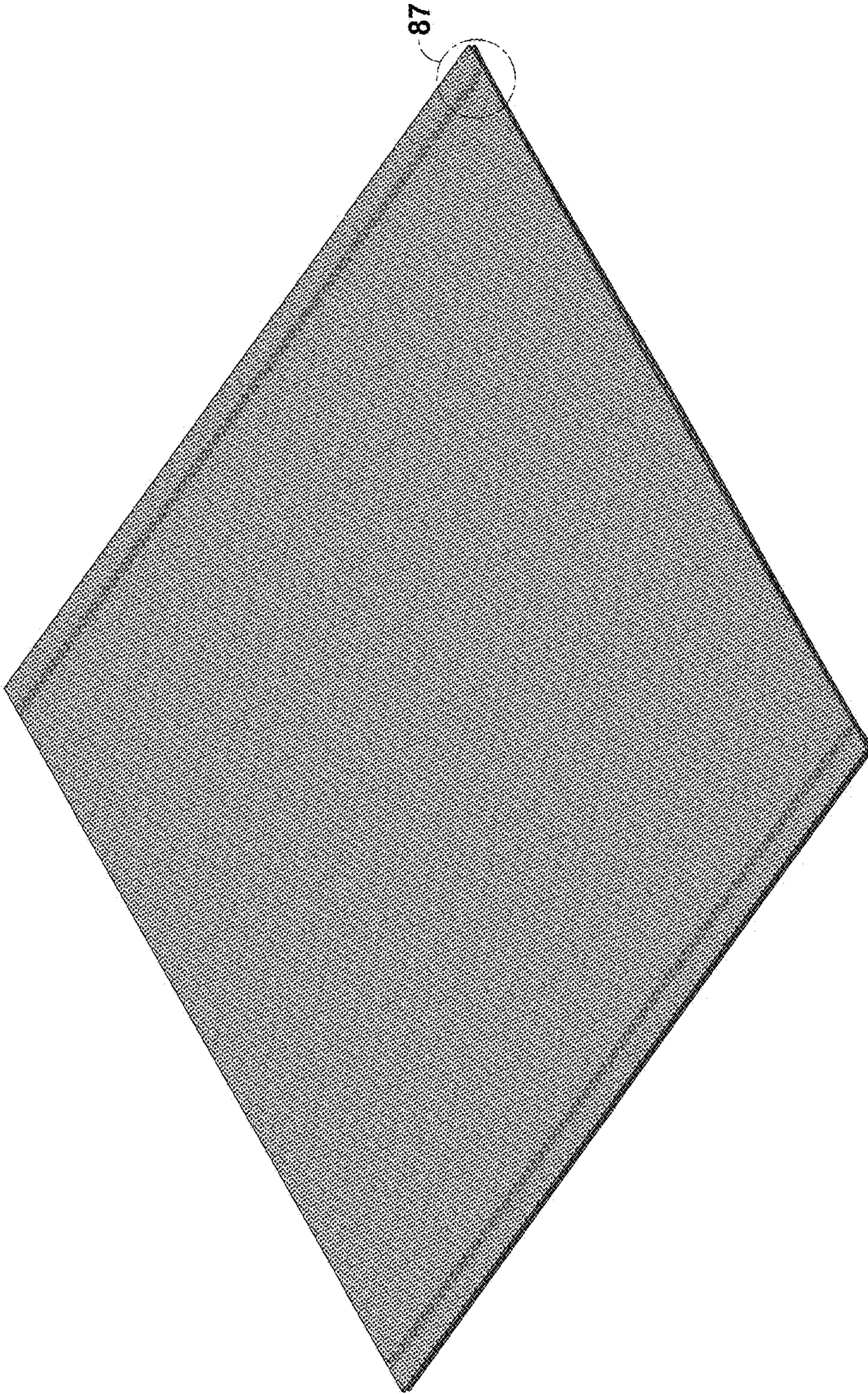

FIG. 82



---

FIG. 83

---

FIG. 84

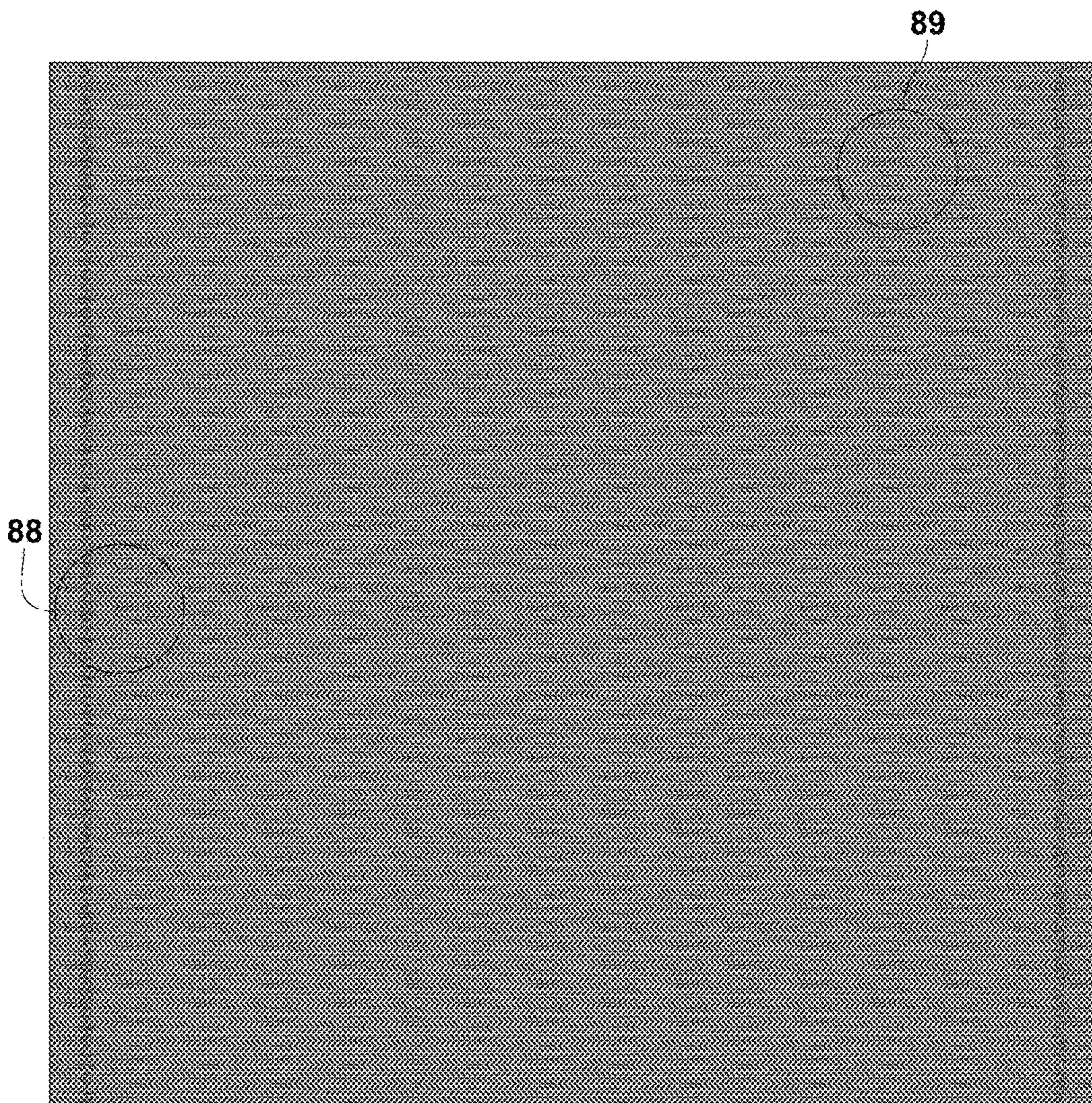

FIG. 85

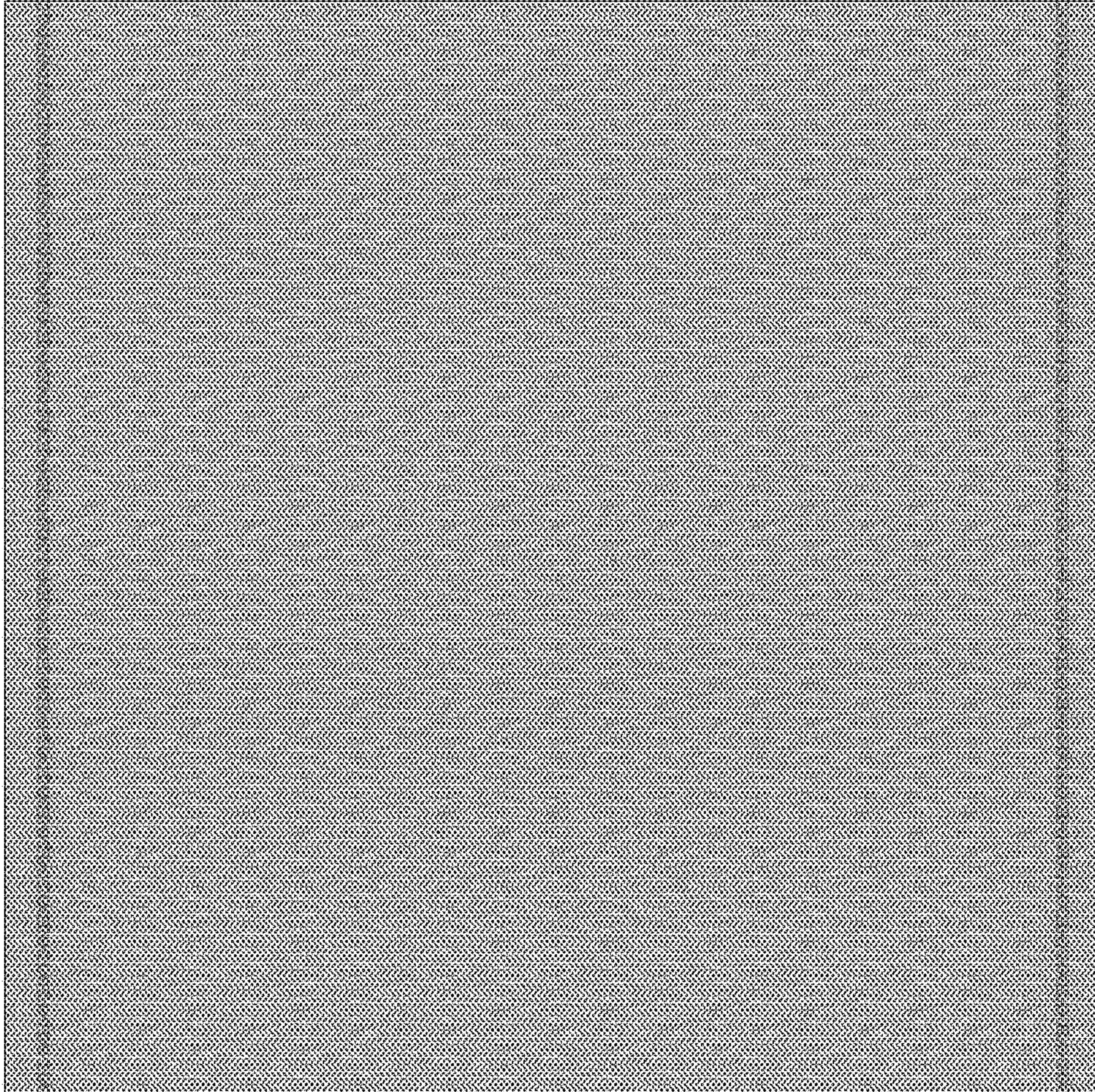

FIG. 86

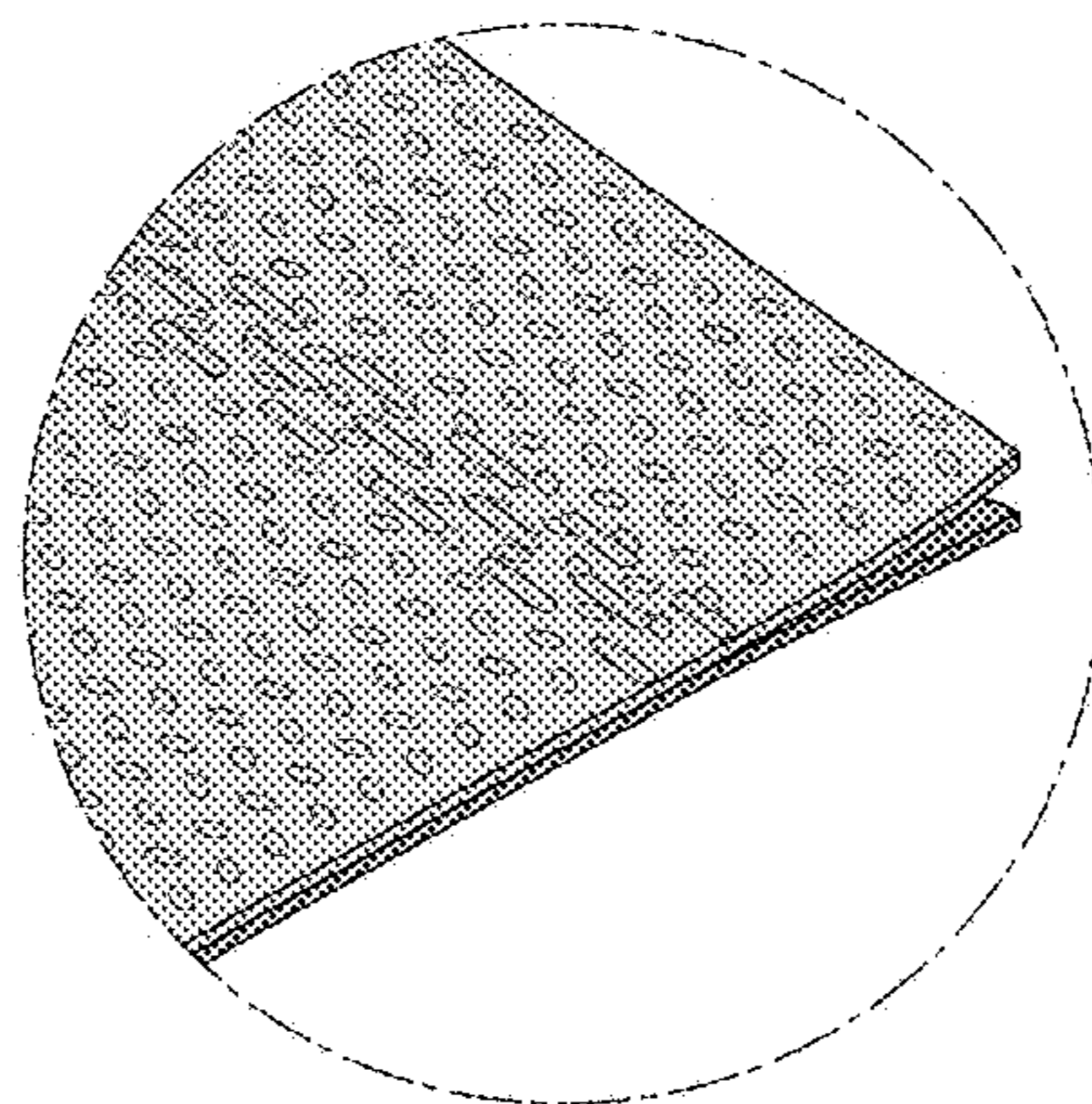

FIG. 87

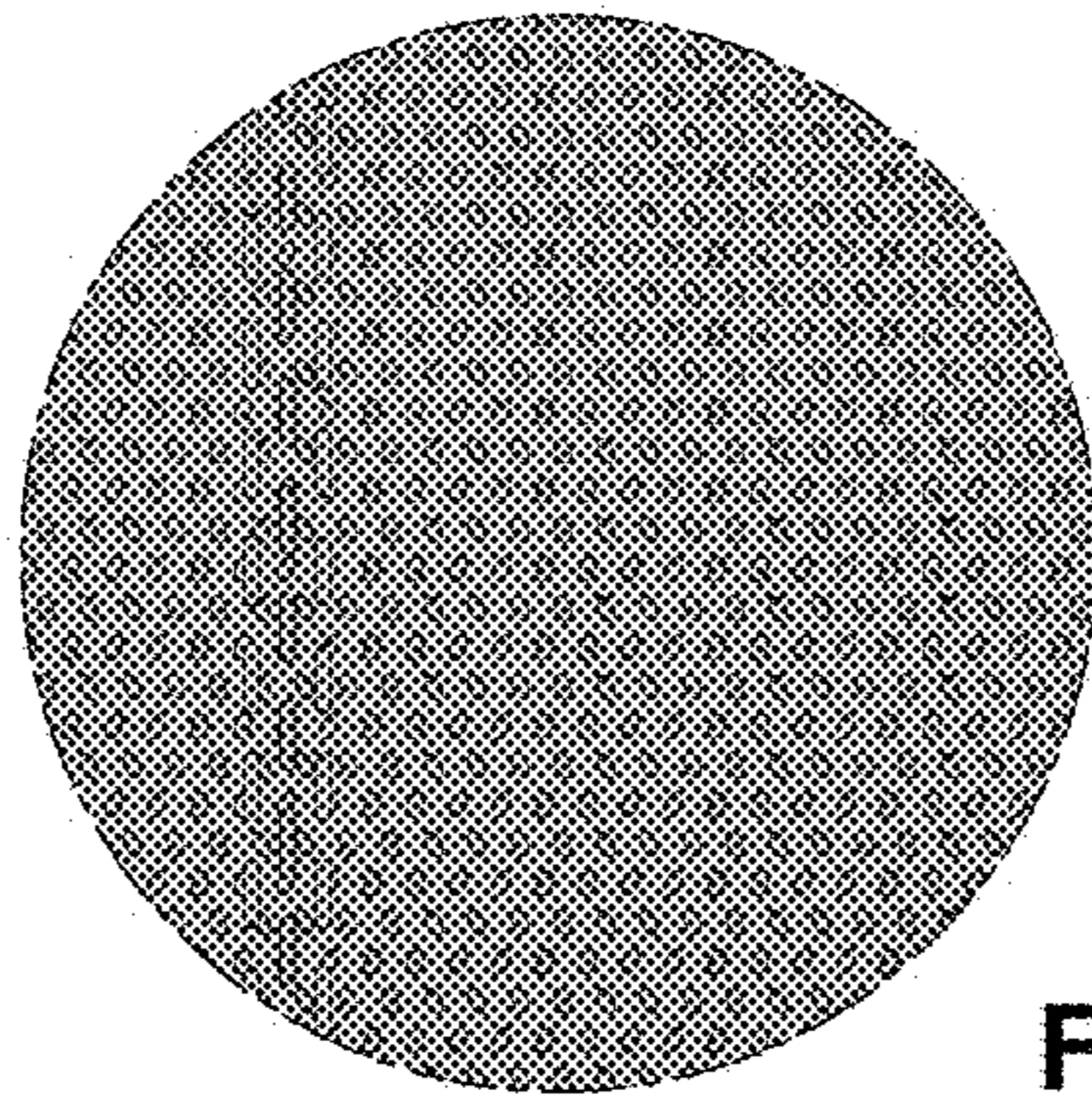

FIG. 88

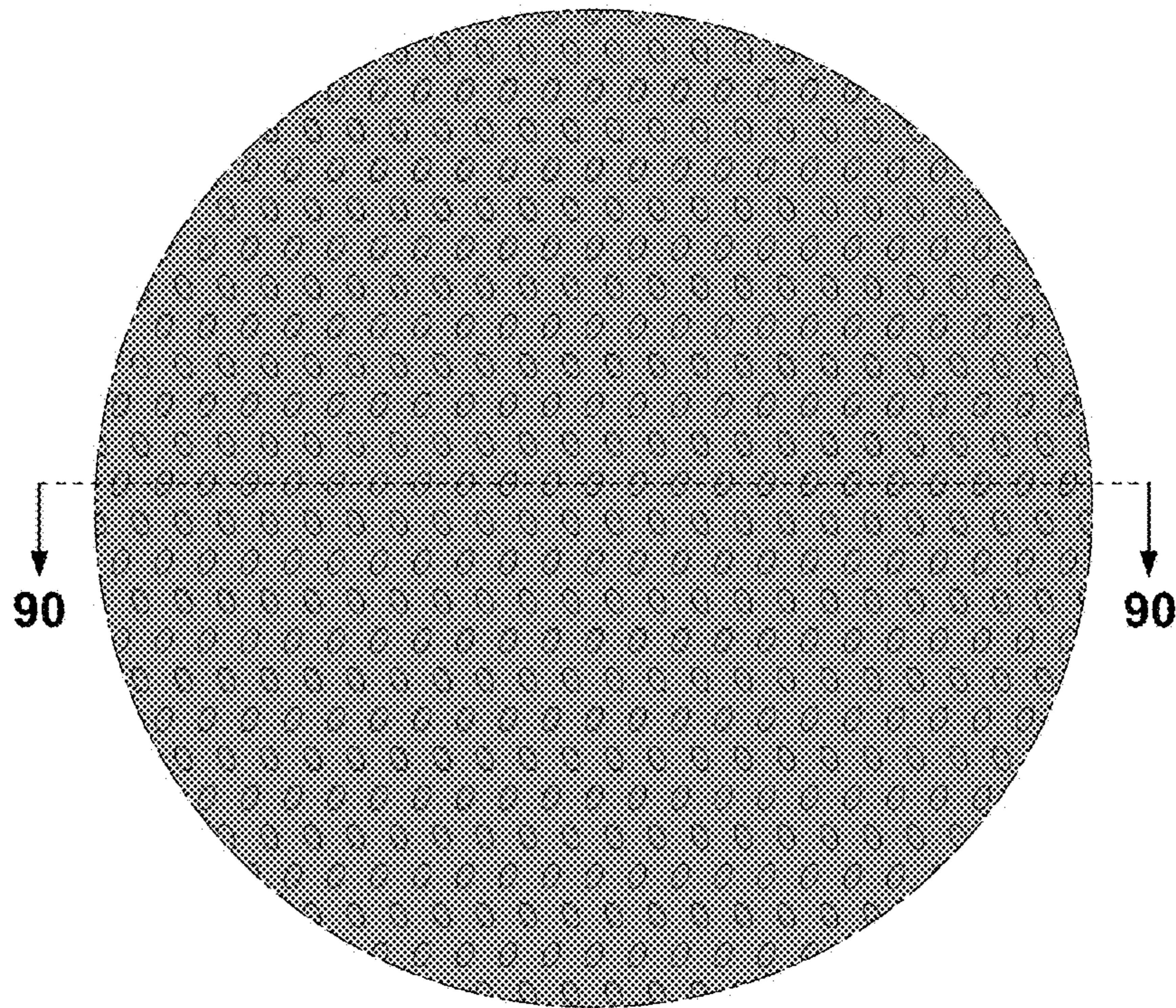

FIG. 89

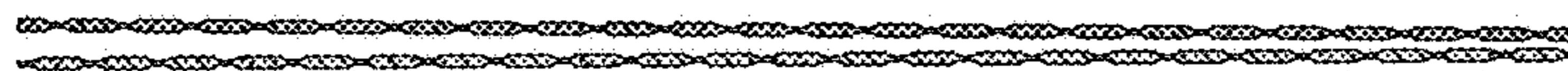

FIG. 90