



US00D838927S

(12) **United States Design Patent**
Wu

(10) **Patent No.:** **US D838,927 S**

(45) **Date of Patent:** **** Jan. 22, 2019**

(54) **HANDLE BAR FOR CONDUIT DREDGE**

(71) Applicant: **Kuei-Kun Wu**, Kaohsiung (TW)

(72) Inventor: **Kuei-Kun Wu**, Kaohsiung (TW)

(**) Term: **15 Years**

(21) Appl. No.: **29/609,467**

(22) Filed: **Jun. 30, 2017**

(51) **LOC (11) Cl.** **15-05**

(52) **U.S. Cl.**
USPC **D32/34; D32/14**

(58) **Field of Classification Search**
USPC D32/1, 14, 25, 34, 35; D23/223, 224;
D6/524; D28/7; 4/255.05, 255.01,
4/255.12, 255.09, 255.11; 15/406
CPC .. E03D 9/00; E03C 1/30; E03C 1/308; A47K
11/10
See application file for complete search history.

(56) **References Cited**

U.S. PATENT DOCUMENTS

D291,863 S *	9/1987	Kolonia	D8/10
6,067,668 A *	5/2000	Rudd	E03C 1/308 4/255.01
6,131,972 A *	10/2000	Whitehead	B25G 1/102 16/430
D457,279 S *	5/2002	Ingram	D32/35
D495,841 S *	9/2004	Smith	D32/35
D508,151 S *	8/2005	Hay	D32/14
D511,597 S *	11/2005	Morrow	D32/14
D576,253 S *	9/2008	Cheng	D23/223

D593,821 S *	6/2009	Kopp	D8/10
D604,573 S *	11/2009	Boies	D8/10
D722,210 S *	2/2015	Gwen	D32/14
D813,479 S *	3/2018	Balz	D32/35
2017/0361362 A1 *	12/2017	Elam, Sr.	B08B 9/035

FOREIGN PATENT DOCUMENTS

EM	004093102-0001	*	7/2017
EM	004093102-0003	*	7/2017
EM	004093102-0004	*	7/2017

* cited by examiner

Primary Examiner — Cynthia Ramirez

Assistant Examiner — Laura H Yu

(74) *Attorney, Agent, or Firm* — WPAT, PC

(57) **CLAIM**

The ornamental design for a handle bar for a conduit dredge, as shown and described.

DESCRIPTION

FIG. 1 is a perspective view of a handle bar for a conduit dredge, showing my new design;
FIG. 2 is a front view thereof;
FIG. 3 is a rear view thereof;
FIG. 4 is a left side view thereof;
FIG. 5 is a right side view thereof; and,
FIG. 6 is a top view thereof.

The dash dot dash lines represent boundary lines of the claimed design and form no part thereof. The evenly spaced broken lines illustrate environment and form no part of the claimed design.

1 Claim, 6 Drawing Sheets

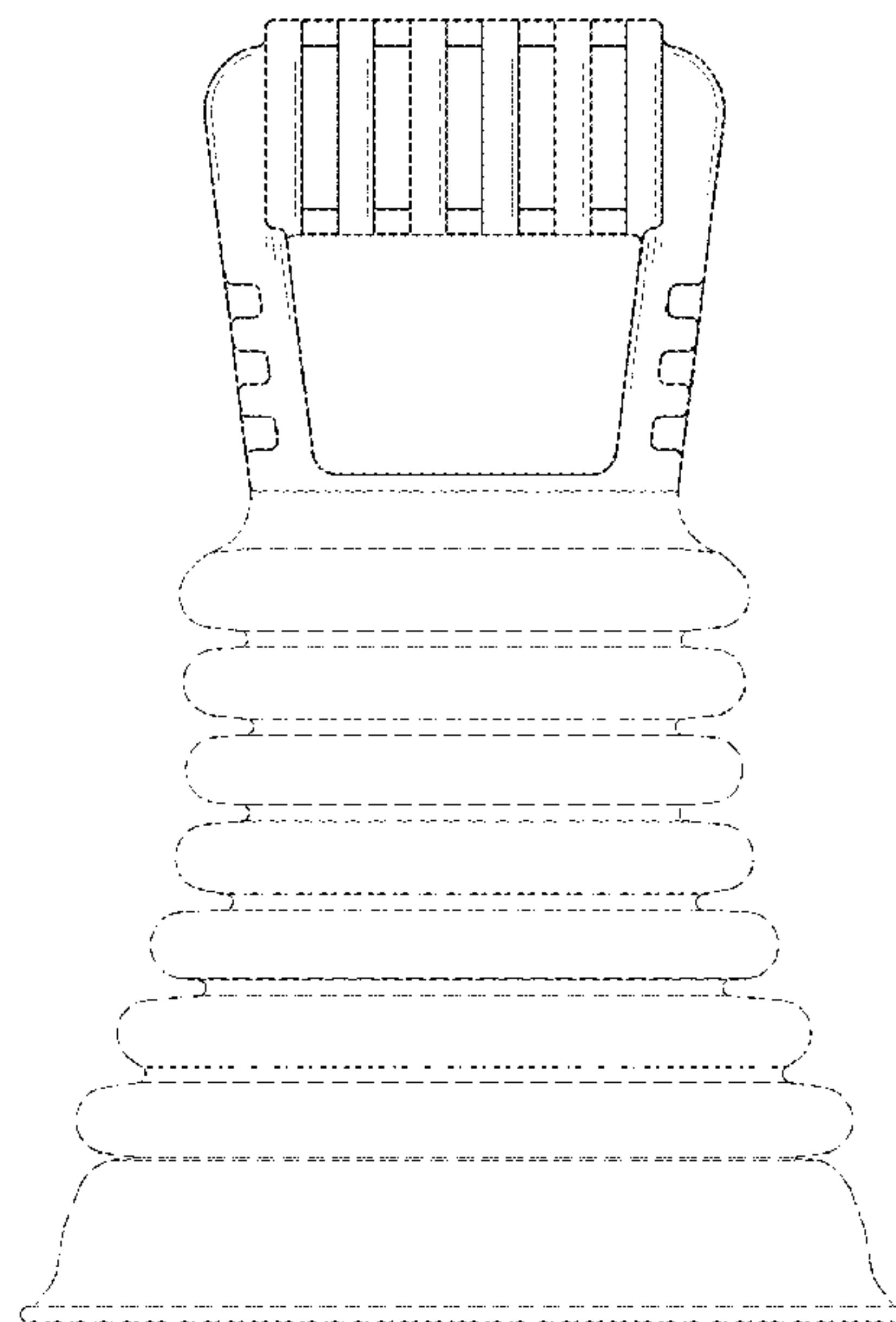
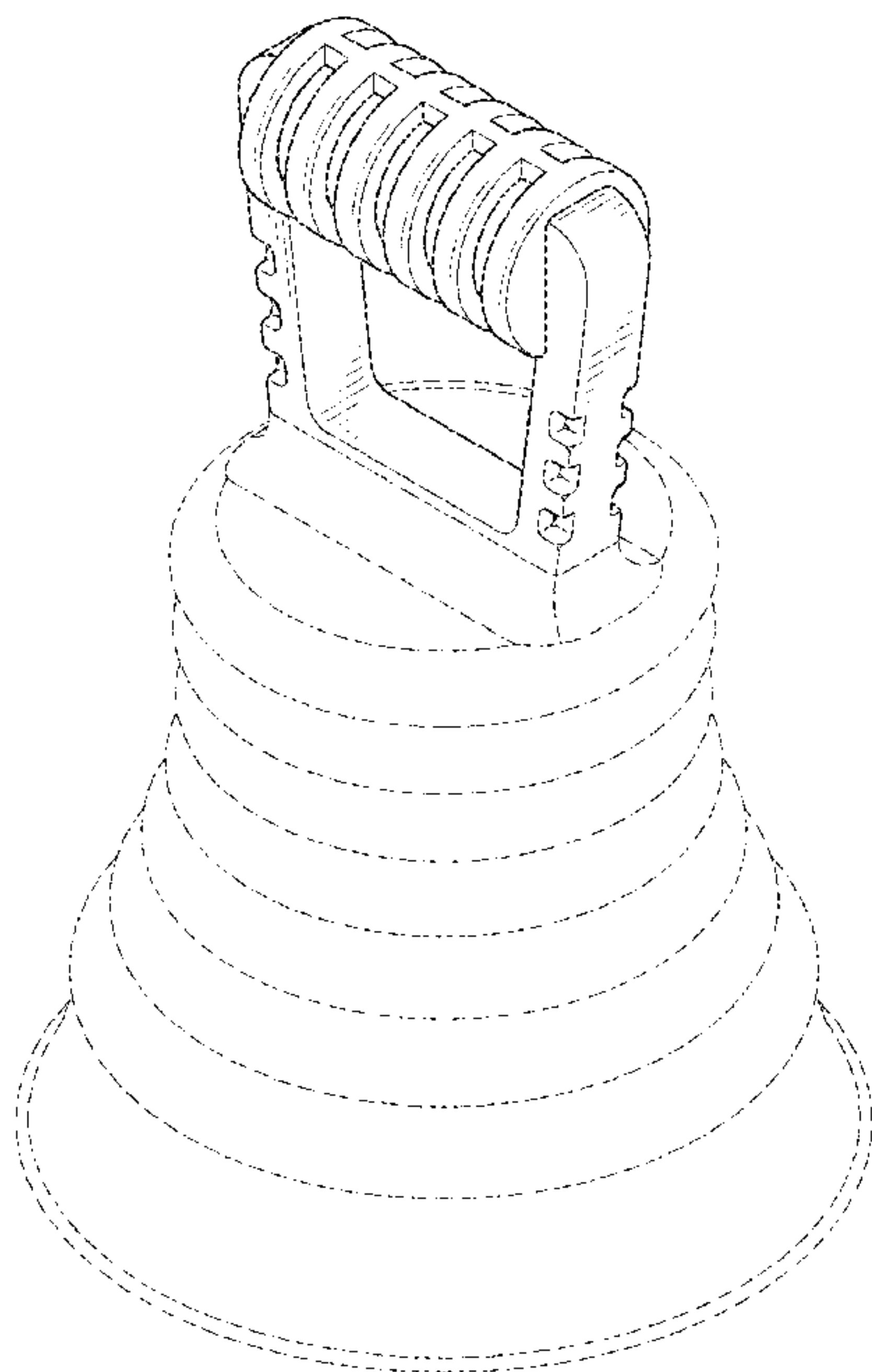

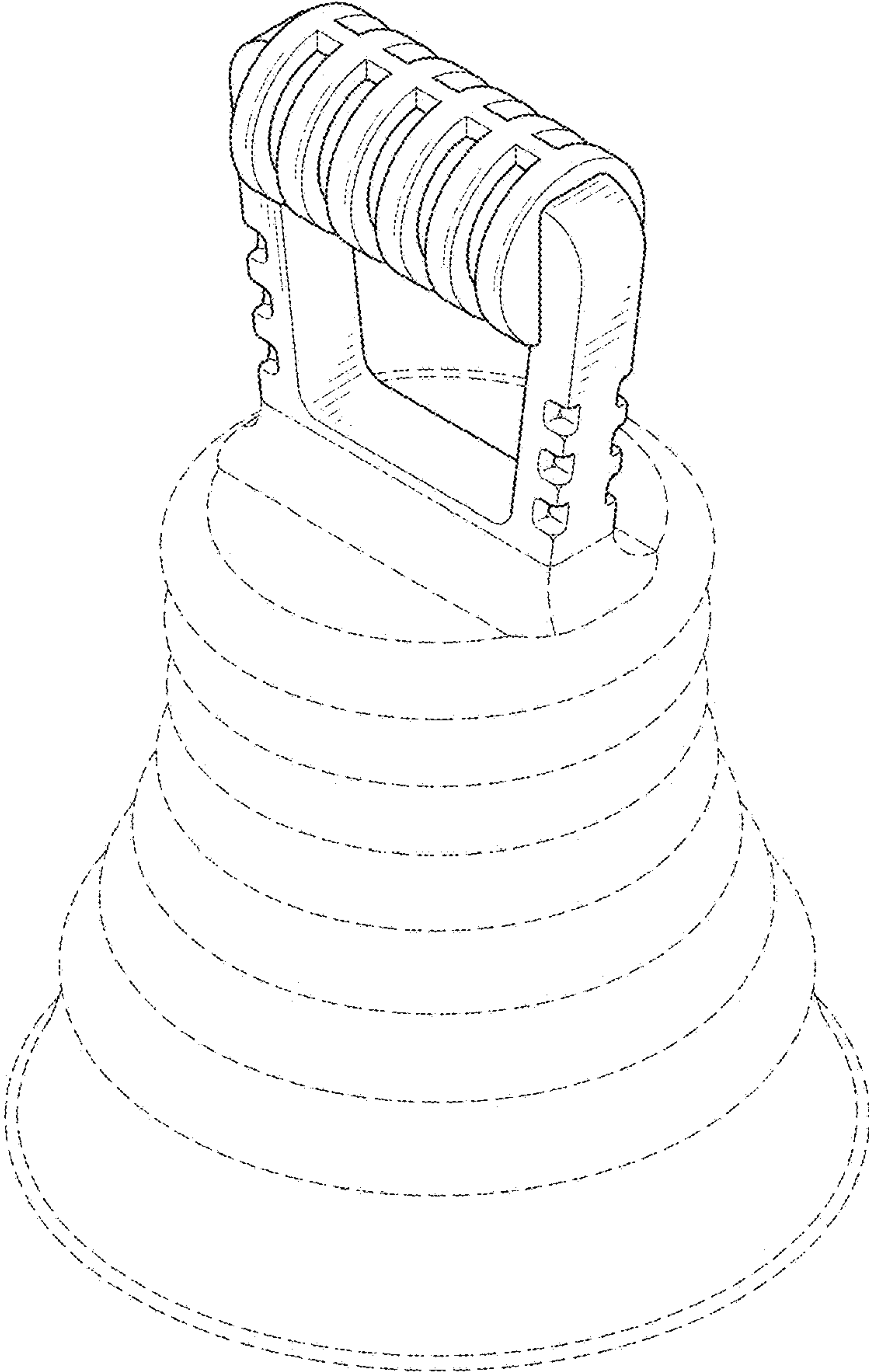

FIG. 1

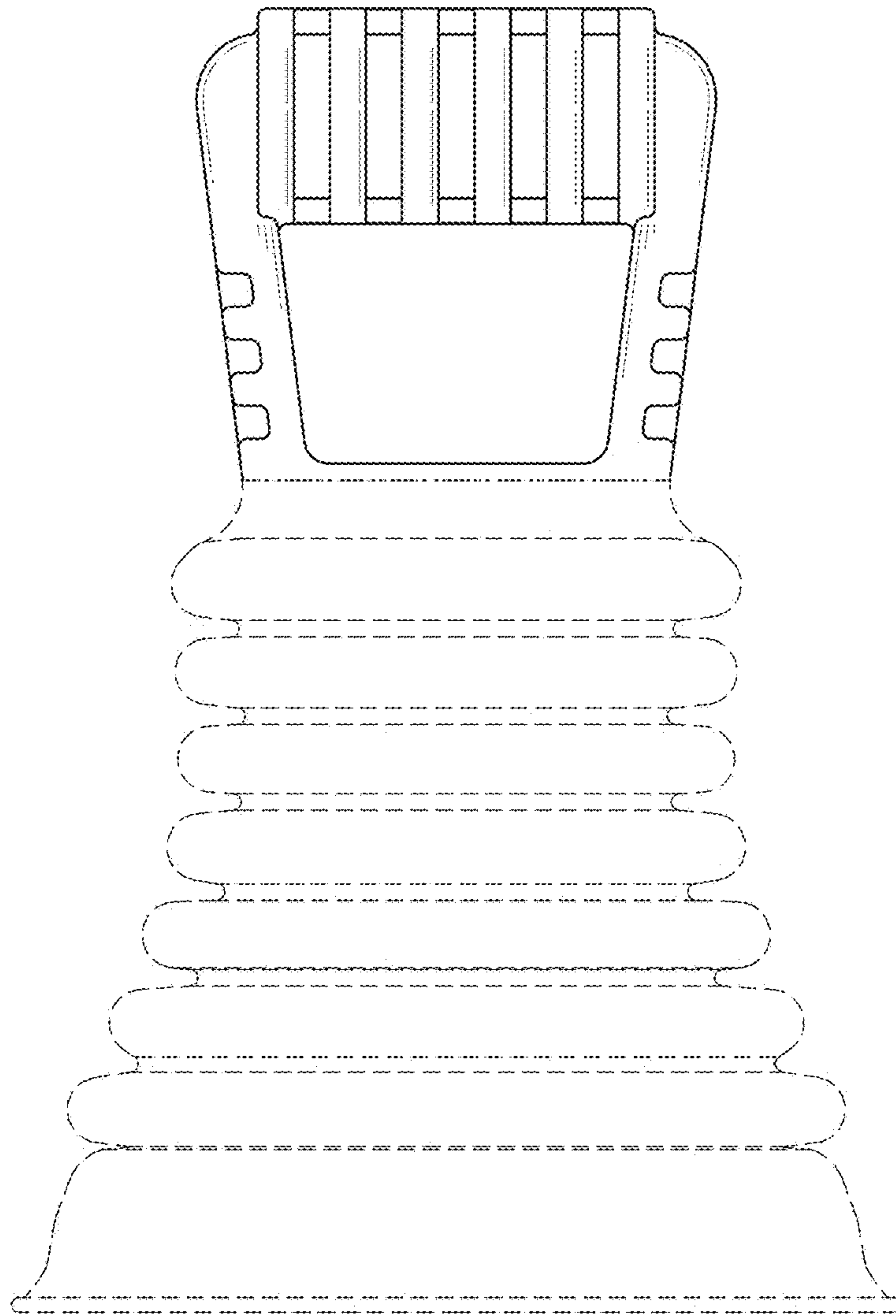

FIG. 2

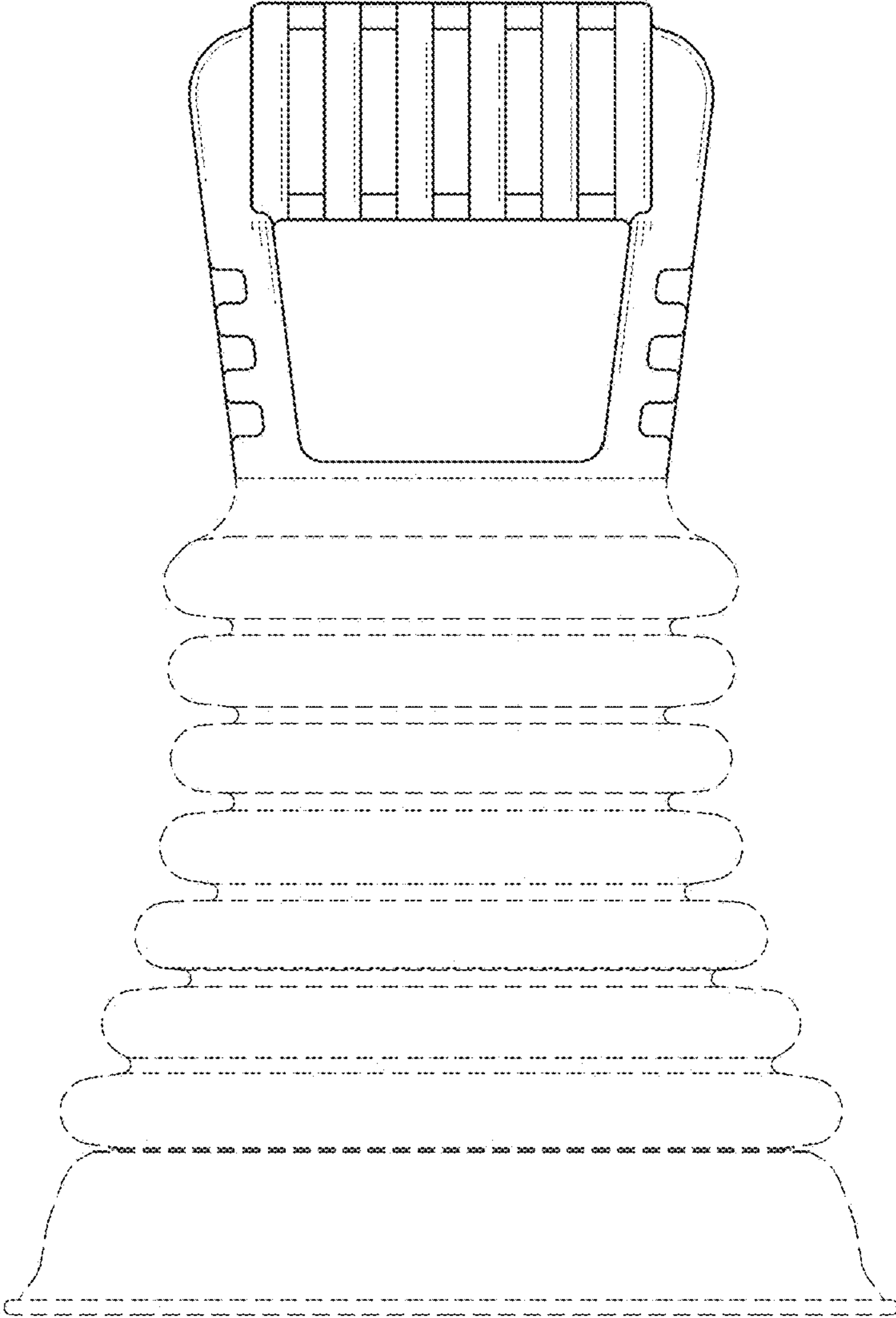

FIG. 3

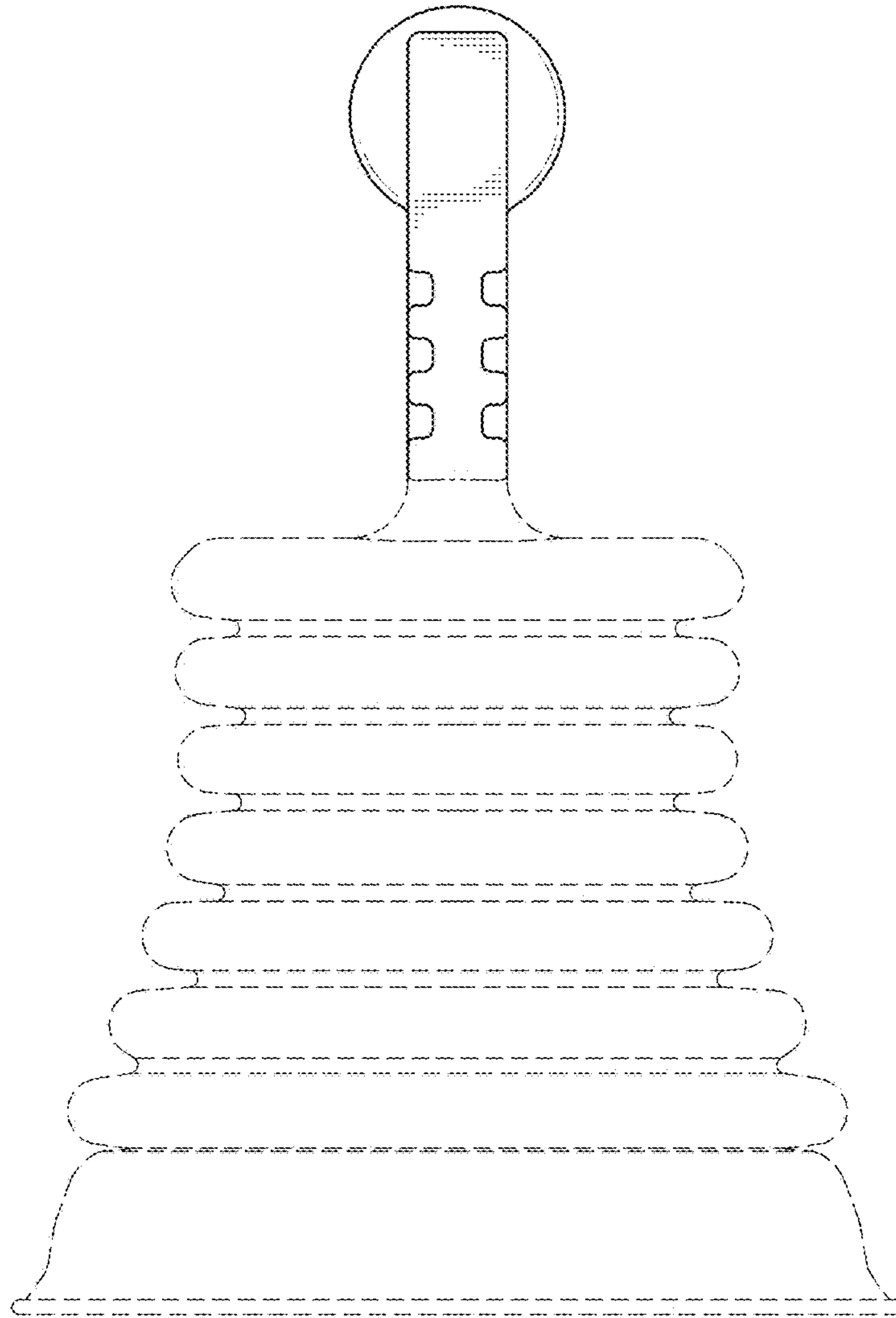

FIG. 4

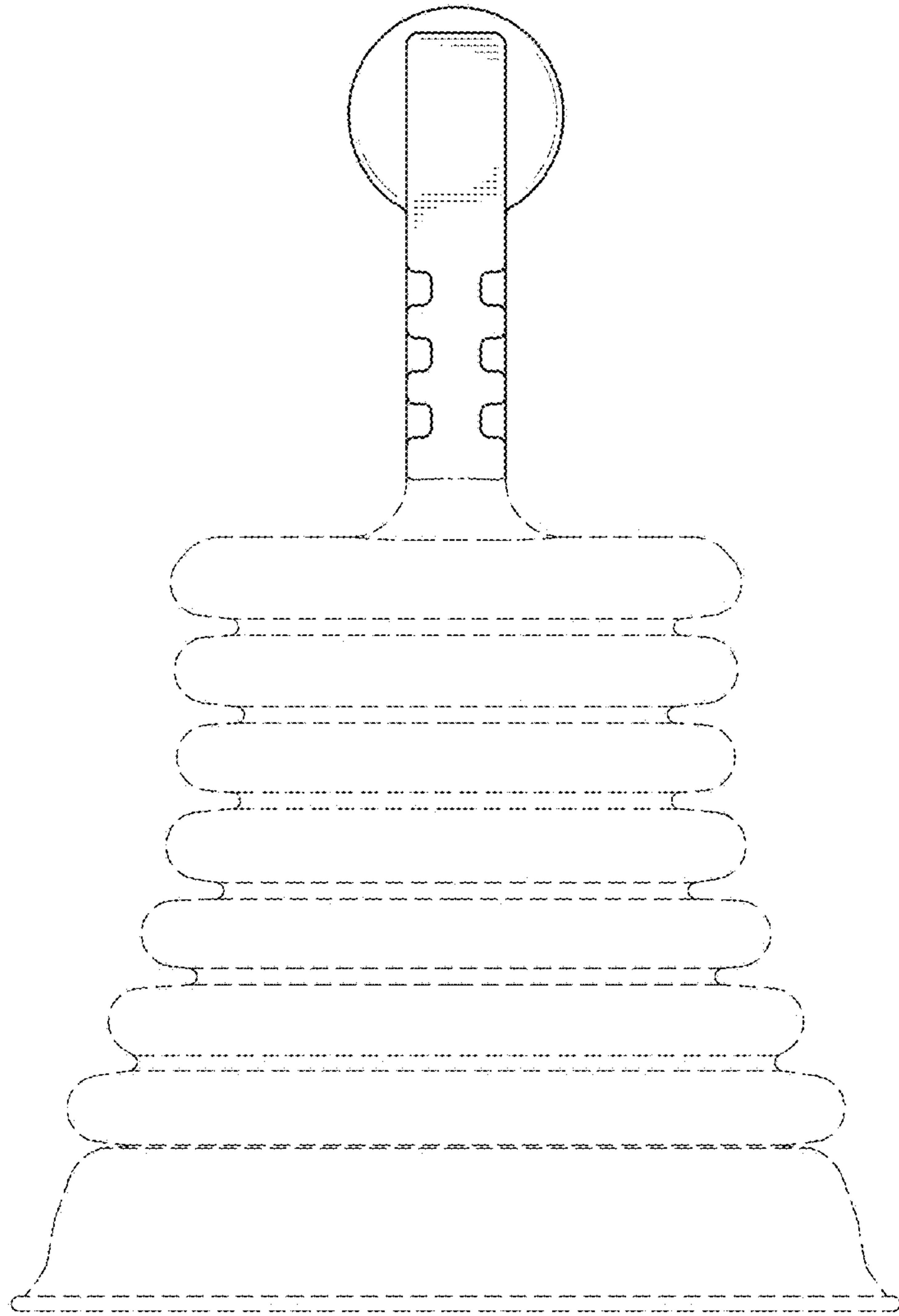

FIG. 5

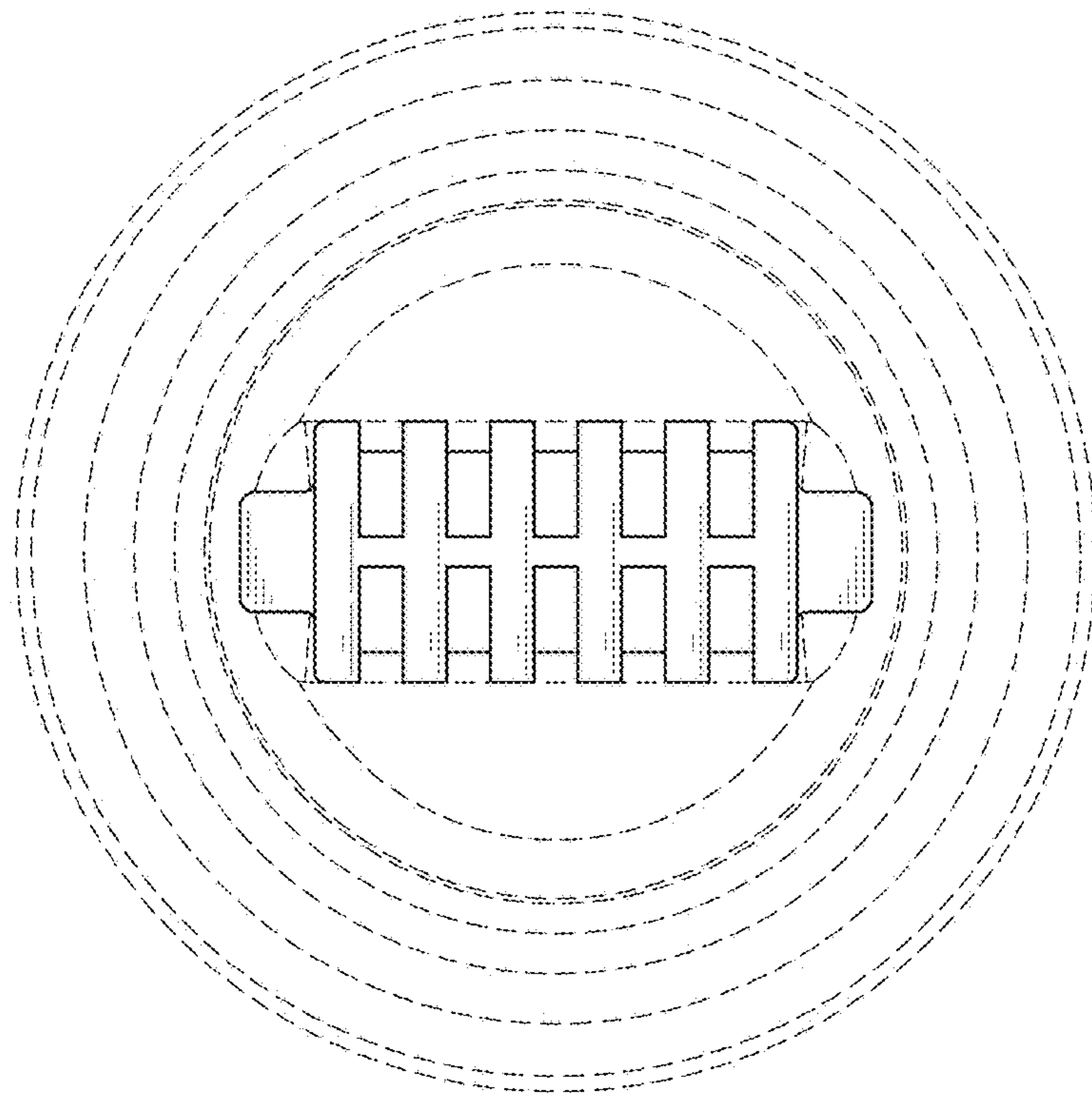

FIG. 6