



US00D838797S

(12) **United States Design Patent**
Denney, Jr. et al.

(10) **Patent No.:** **US D838,797 S**
(45) **Date of Patent:** **** Jan. 22, 2019**

- (54) **MODEL OF AN ANIMAL PORTION**
- (71) Applicant: **Contact Left, LLC**, Redmond, WA (US)
- (72) Inventors: **John D. Denney, Jr.**, Seattle, WA (US);
Jeff Rodriguez, Seattle, WA (US)
- (73) Assignee: **Contact Left, LLC**, Seattle, WA (US)
- (**) Term: **15 Years**
- (21) Appl. No.: **29/639,638**
- (22) Filed: **Mar. 7, 2018**
- (51) **LOC (11) Cl.** **21-02**
- (52) **U.S. Cl.**
USPC **D21/808**; D21/597
- (58) **Field of Classification Search**
USPC D21/398, 411, 412, 413, 414, 415, 416,
D21/417, 418, 419, 420, 421, 436, 437,
D21/438, 439, 440, 441, 447, 451, 453,
D21/473, 483, 490, 584, 597, 606, 607,
D21/608, 609, 626, 801, 802, 803, 804,
D21/807, 808, 809, 810, 811, 815, 816,
D21/818, 819, 820, 821, 828, 831, 832;
D30/160; D12/5, 6, 316; D6/392, 395,
D6/596, 601, 604, 605; D11/44, 47, 49,
D11/58, 82, 100, 107, 134, 137, 158,
D11/162; 114/253, 345, 346; 441/35,
441/66, 74, 40, 41, 42, 129, 130, 131,
441/132; 472/128, 129; D1/104, 107
CPC B63B 35/74; B63B 35/76; B63B 35/78;
B63B 35/79; B63B 35/7906; B63B
35/7909; B63B 35/7913; B63B 35/7916;
B63B 35/792; B63B 35/7923; B63B
35/7926; B63B 35/793; B63B 114/345;
B63B 114/346; B63B 441/35; B63B
441/66; B63B 441/40; B63B 441/41;
B63B 441/129; B63B 441/13; B63B
441/131; B63B 441/132; B63B 472/128;
B63B 472/129; B63C 9/11; B63C

2009/0023; B63C 9/08; B63C 2009/042;
B63C 2009/046; A63B 31/10; A63B
31/11; A63B 31/12; A63B 31/00; A63B
31/08; A63H 23/10
See application file for complete search history.

(56) **References Cited**

U.S. PATENT DOCUMENTS

D268,222 S * 3/1983 Chen 2/158
D308,084 S * 5/1990 Smith D21/599
D350,577 S * 9/1994 Giudice D21/599
(Continued)

OTHER PUBLICATIONS

Available Aug. 10, 2018, [online], [site visited Aug. 10, 2018].
Available from Internet, <URL:https://www.standupfloats.com/
collections/browse-floats/products/inflatable-shark> (Year: 2018).
(Continued)

Primary Examiner — Cathron C Brooks
Assistant Examiner — Katrina N Gonzalez
(74) *Attorney, Agent, or Firm* — Puget Patent; Michael
Gibbons

(57) **CLAIM**

The ornamental design for a model of an animal portion, as
shown and described.

DESCRIPTION

FIG. 1 is a perspective view of a model of an animal portion
showing our new design;
FIG. 2 is a front view thereof;
FIG. 3 is a rear view thereof;
FIG. 4 is a right side view thereof;
FIG. 5 is a left side view thereof;
FIG. 6 is a top view thereof; and,
FIG. 7 is a bottom view thereof.

1 Claim, 7 Drawing Sheets

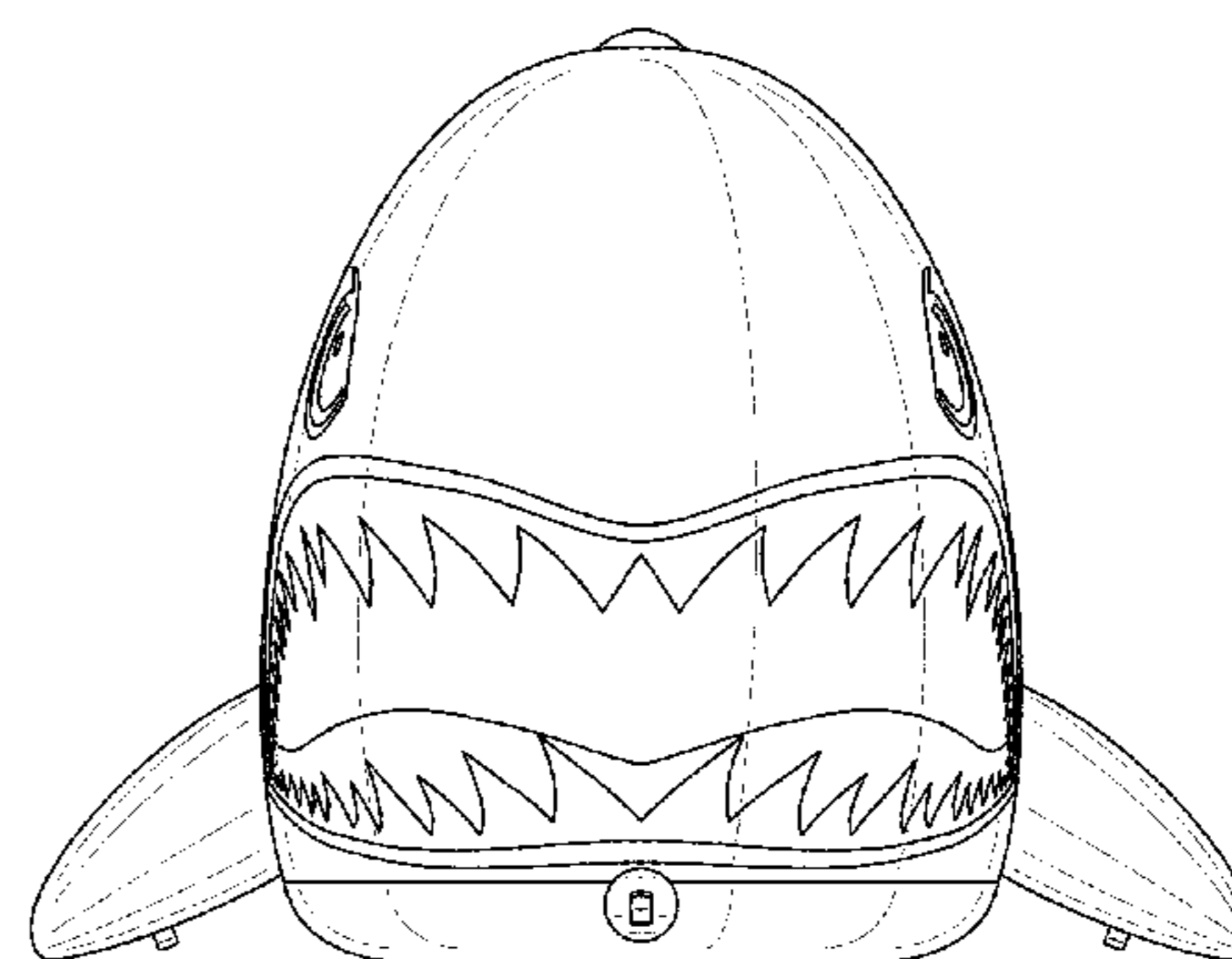
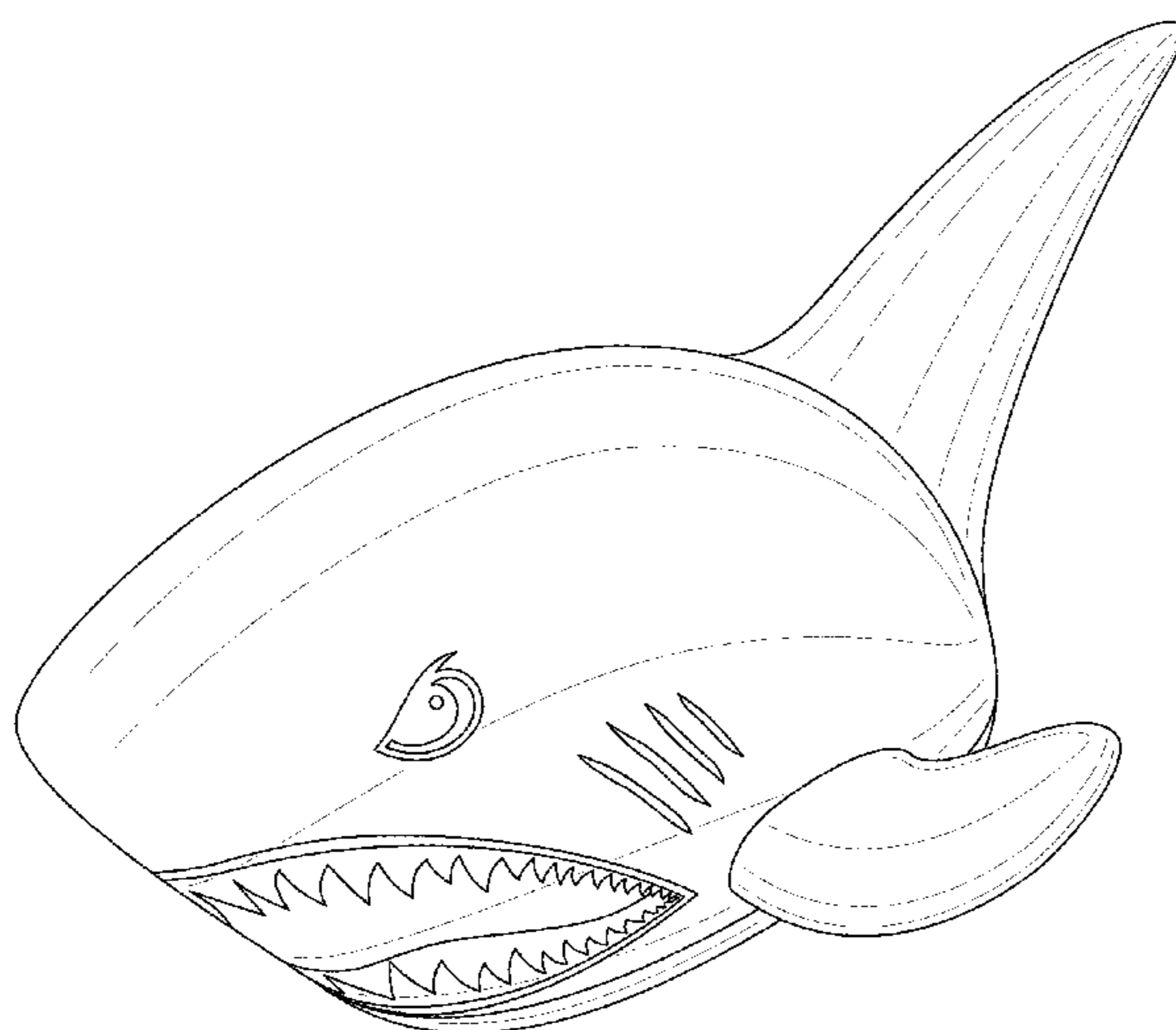

(56)

References Cited

U.S. PATENT DOCUMENTS

5,865,662 A * 2/1999 Dammann A63H 23/10
273/140
D428,079 S * 7/2000 Yamazaki D21/398
D562,929 S * 2/2008 Fitzgerald D21/819
D569,452 S * 5/2008 Bruneel D11/158
D607,064 S * 12/2009 Thorsen D21/599
D608,846 S * 1/2010 Su D21/592
D677,341 S * 3/2013 English D21/439
D699,033 S * 2/2014 Welch D21/599
D713,896 S * 9/2014 Zapf D21/576
D720,115 S * 12/2014 Kawlath D21/597
D731,002 S * 6/2015 Phillips D21/599
D800,861 S * 10/2017 Hsu D21/808
2012/0289118 A1 * 11/2012 Ohrn A63H 23/10
446/153
2015/0190723 A1 * 7/2015 Liberatore A63G 19/00
446/153

OTHER PUBLICATIONS

Available Apr. 18, 2018, [online], [site visited Aug. 10, 2018].
Available from Internet, <URL:https://www.facebook.com/
StandUpFloats/photos/a.1931830443809077.1073741828.
1849761052016017/2033688353623285/?type=3&theater> (Year:
2018).*

Available Jun. 9, 2018, [online], [site visited Aug. 11, 2018].
Available from Internet, <URL:http://sidewalkdelivery.co/dolphin-
pool-float/> (Year: 2018).*

* cited by examiner

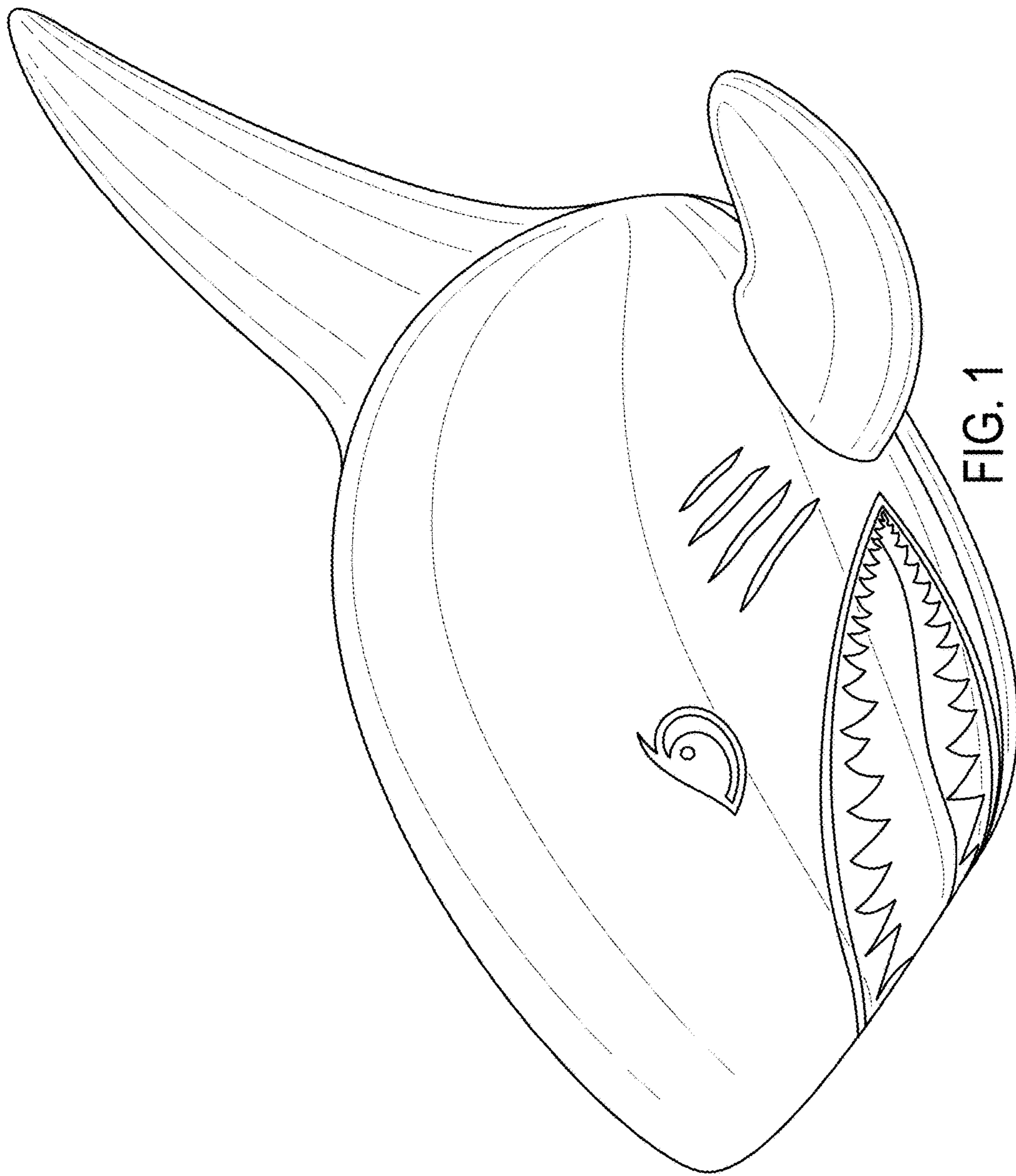

FIG. 1

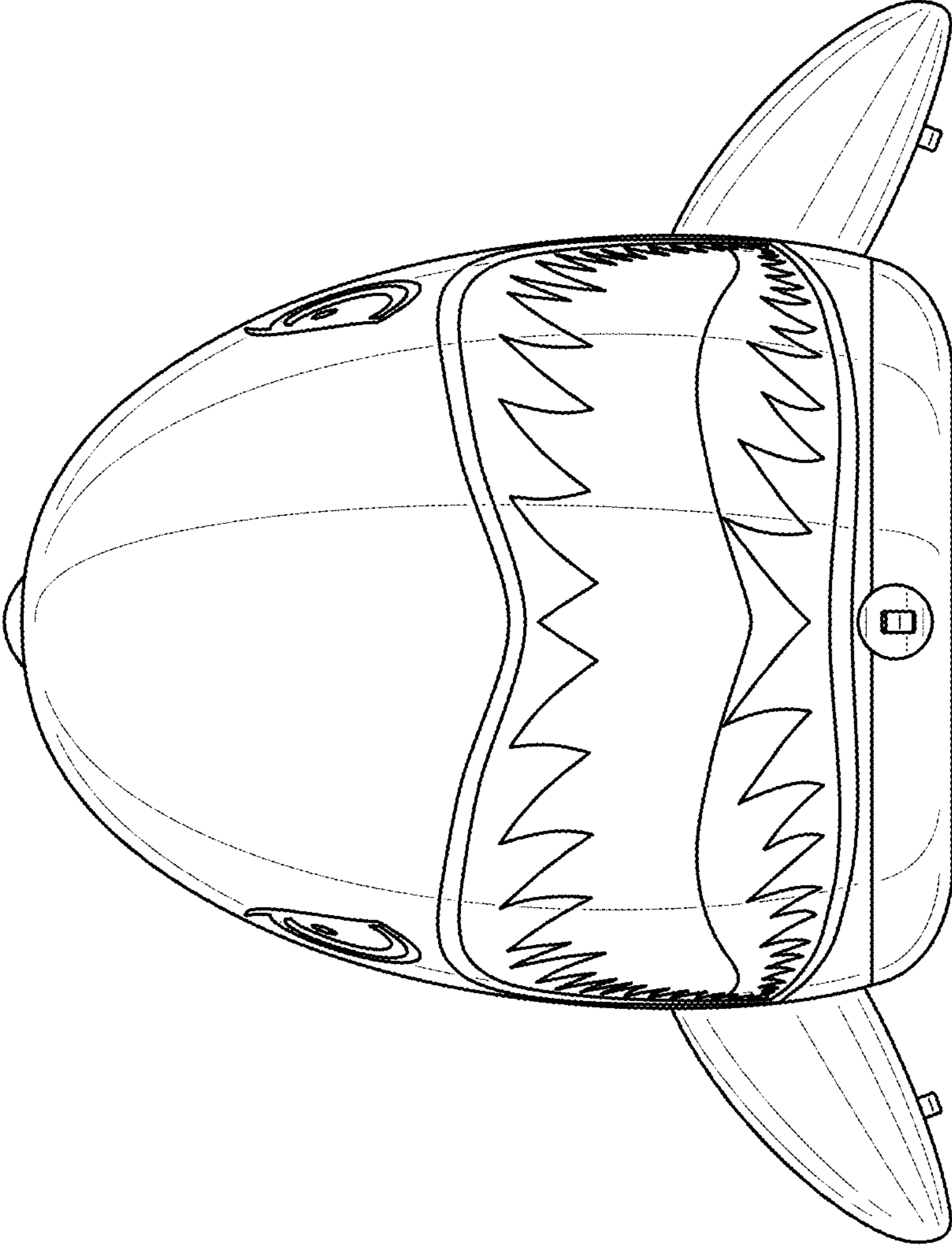

FIG. 2

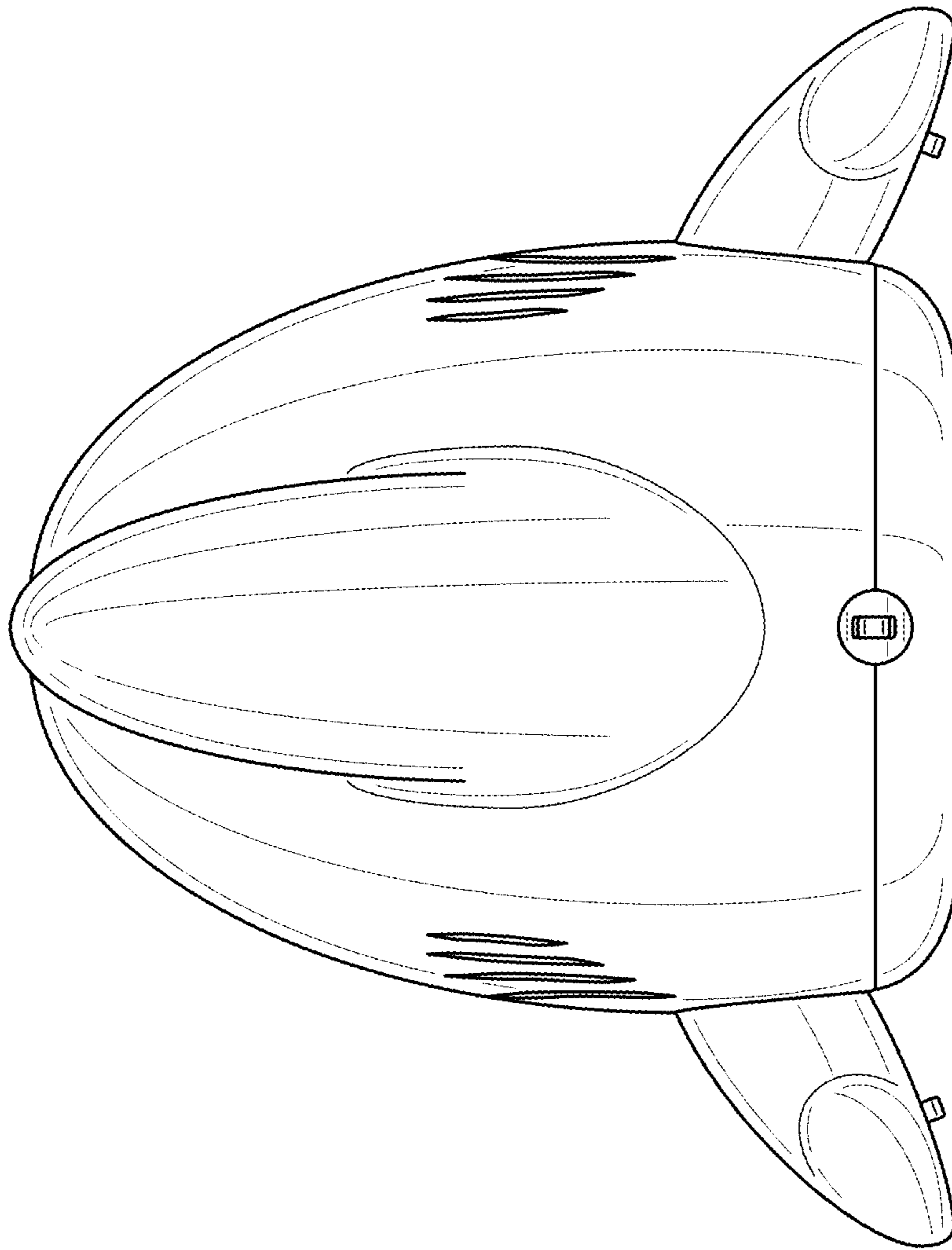

FIG. 3

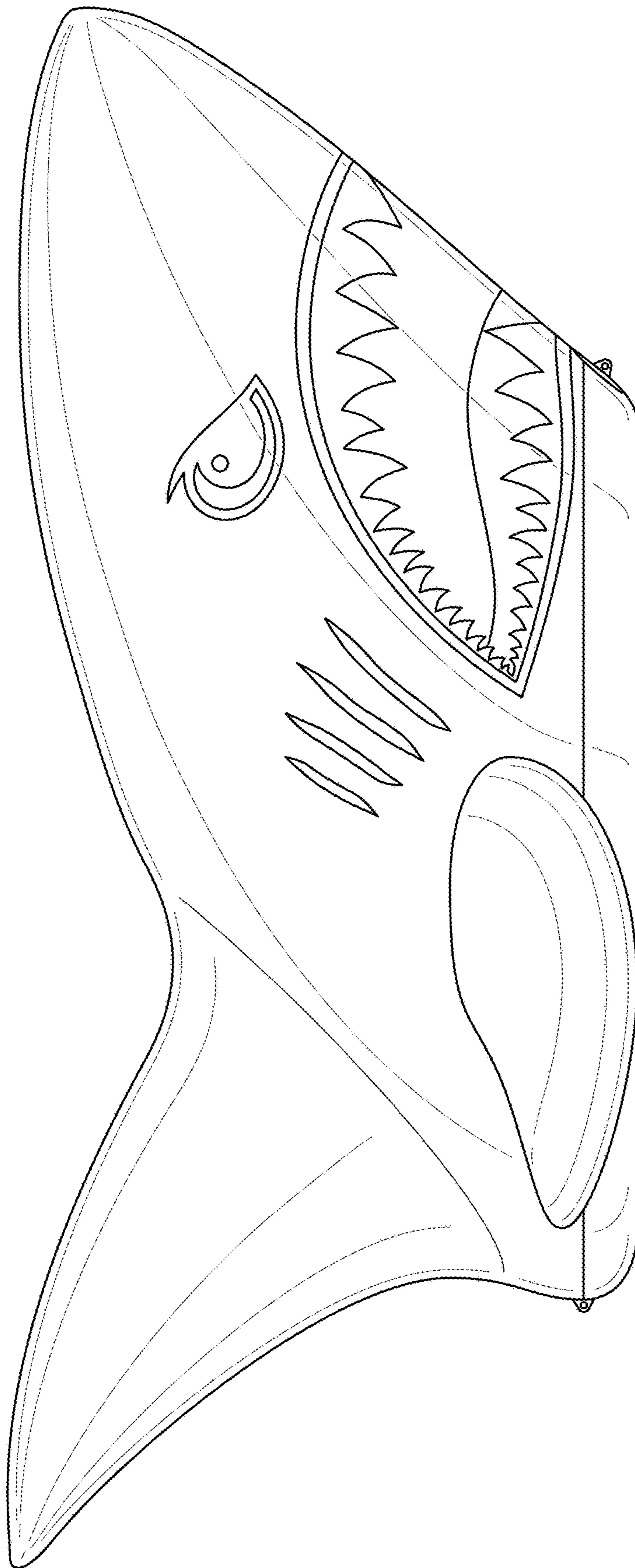

FIG. 4

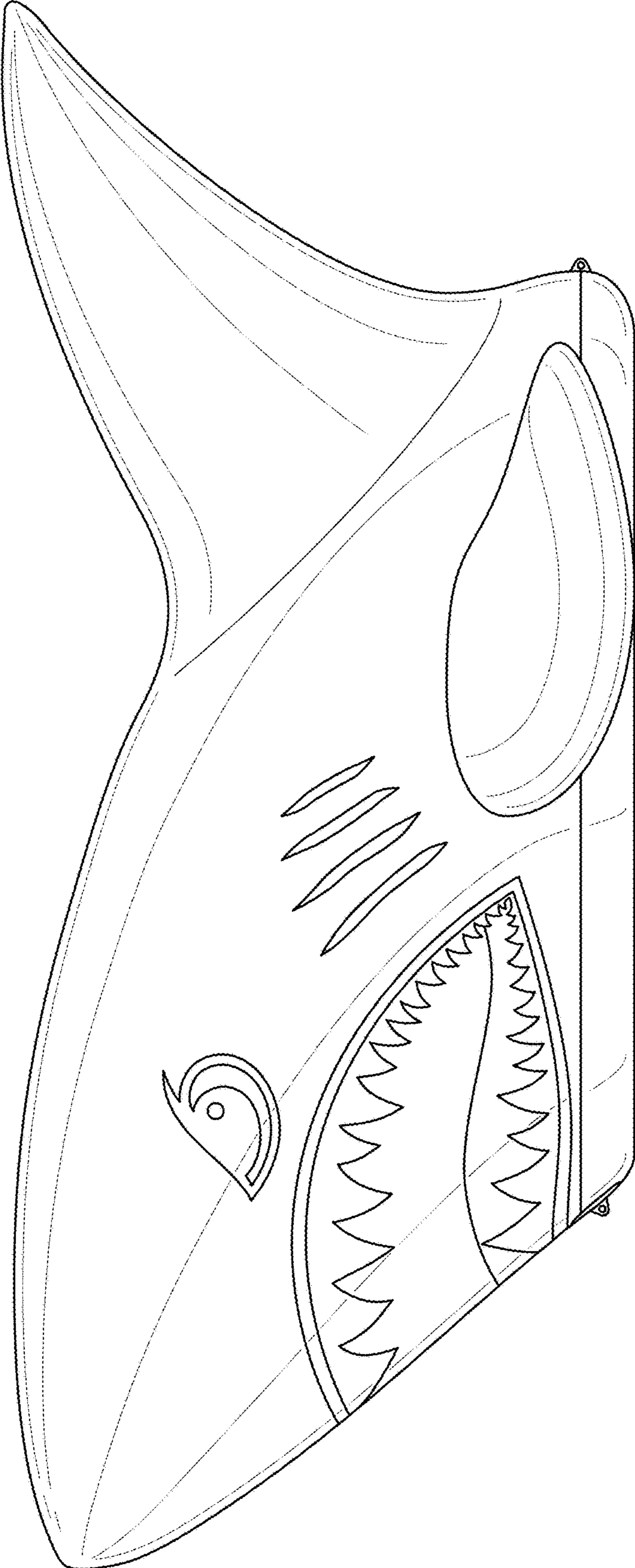

FIG. 5

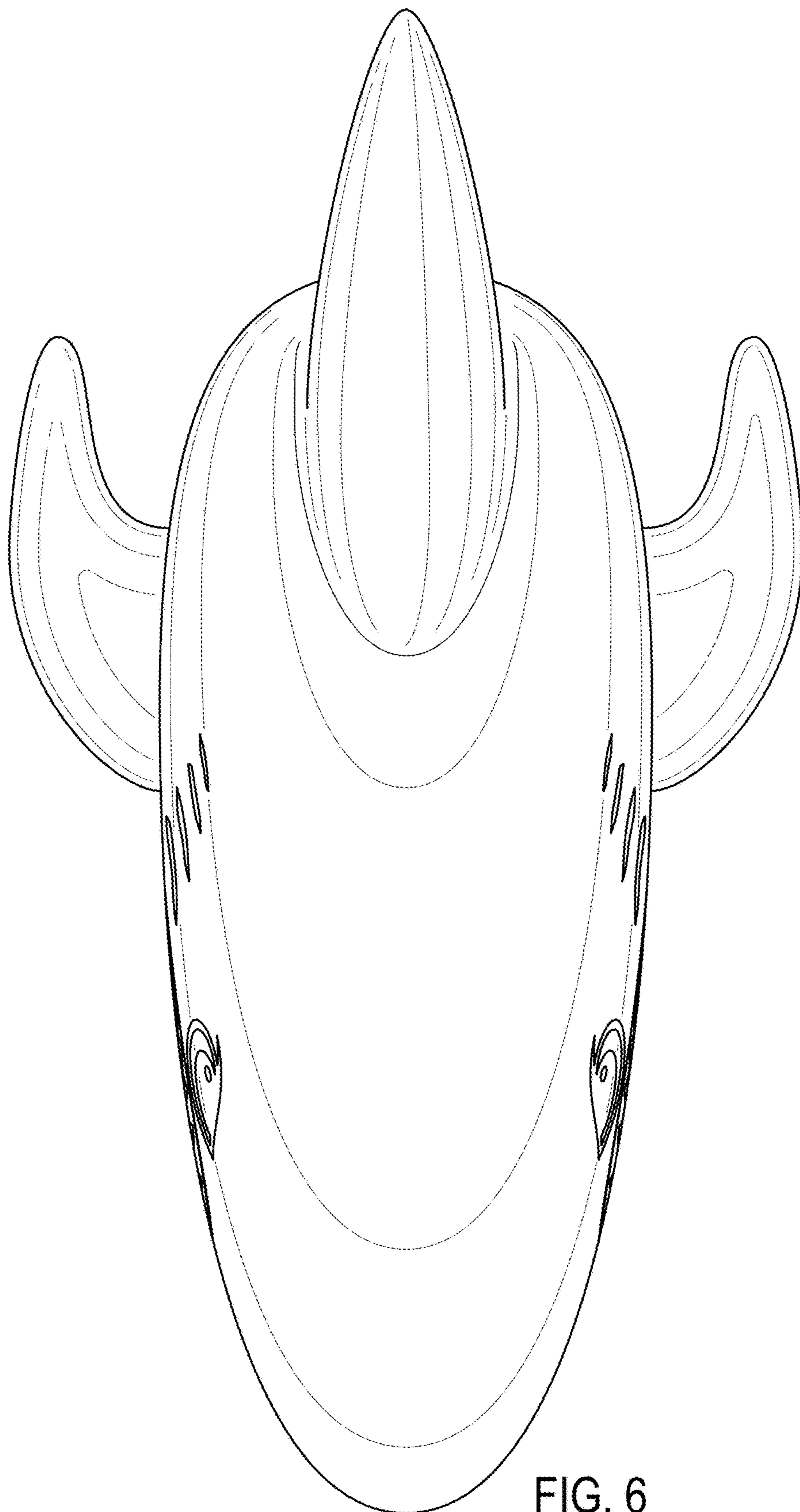

FIG. 6

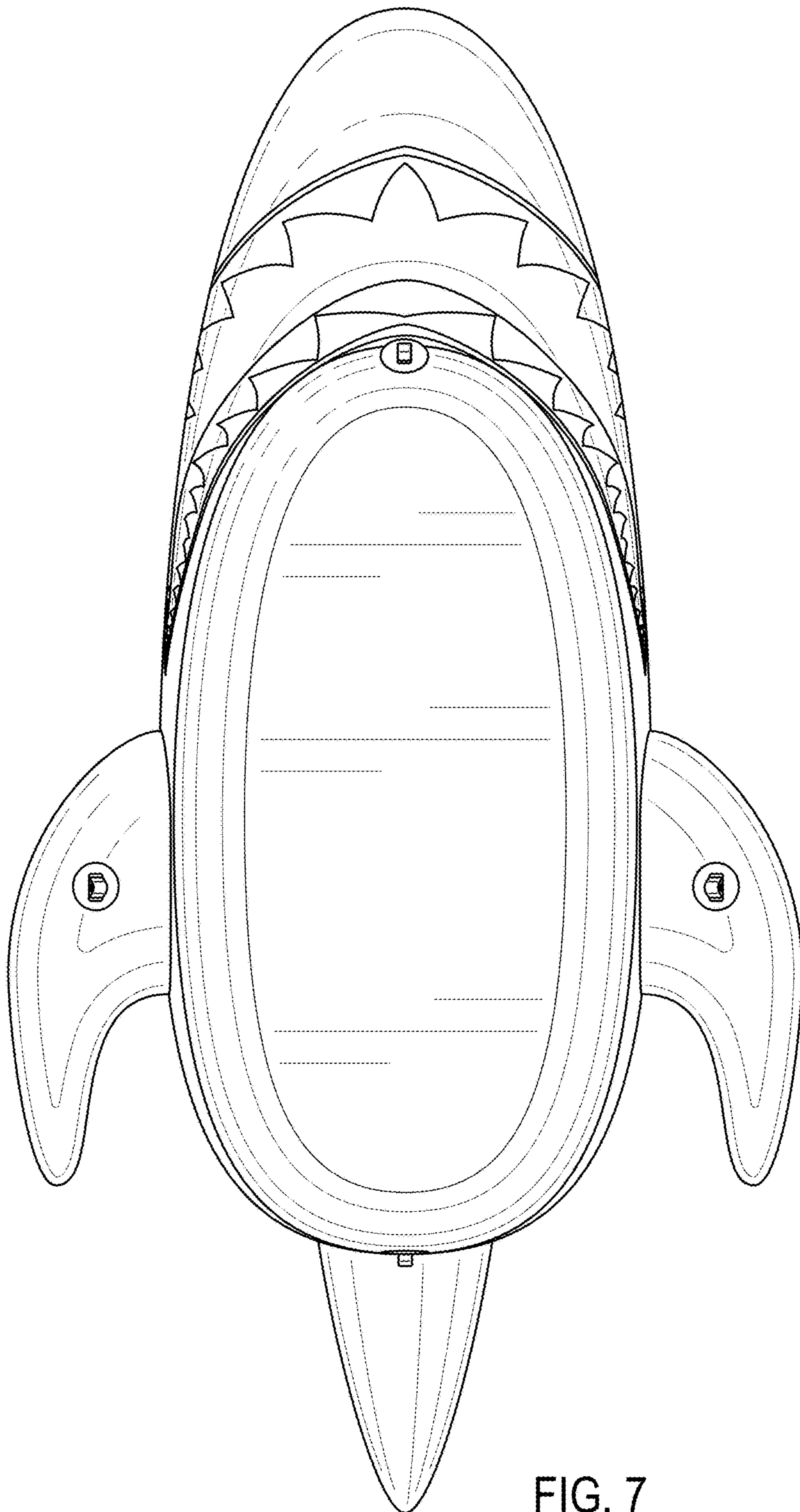

FIG. 7