



US00D838777S

(12) **United States Design Patent** (10) **Patent No.:** **US D838,777 S**
Schnug (45) **Date of Patent:** **** Jan. 22, 2019**

(54) **PEN**
(71) Applicant: **PRODIR SA**, Lamone (CH)
(72) Inventor: **Christoph Schnug**, Berlin (DE)
(73) Assignee: **Pagani Pens, S.A.**, Cadempino (CH)
(**) Term: **15 Years**
(21) Appl. No.: **35/503,058**
(22) Filed: **Apr. 28, 2017**

D713,880 S * 9/2014 Losel D19/172
D713,881 S * 9/2014 Koch D19/173
D716,378 S * 10/2014 Martin D19/170
D730,987 S * 6/2015 Schnug D19/171
D736,317 S * 8/2015 Miller D19/173
D746,375 S * 12/2015 Ossola D19/177
D765,784 S * 9/2016 Briggl D19/172
D772,983 S * 11/2016 Bo D19/174
D781,293 S * 3/2017 Mitchell D14/411
D783,093 S * 4/2017 Miller D19/173
D797,851 S * 9/2017 Oltman D19/173
D797,852 S * 9/2017 Oltman D19/173
D806,168 S * 12/2017 Briggl D19/172
2006/0228162 A1 * 10/2006 Cetera A45D 34/00
401/195

(80) **Hague Agreement Data**
Int. Filing Date: **Apr. 28, 2017**
Int. Reg. No.: **DM/096074**
Int. Reg. Date: **Apr. 28, 2017**
Int. Reg. Pub. Date: **May 26, 2017**

FOREIGN PATENT DOCUMENTS

WO DM/077100 * 11/2011
WO DM/082338 * 11/2013

* cited by examiner

Primary Examiner — Mary Ann Calabrese
Assistant Examiner — Jennifer L Rempfer
(74) *Attorney, Agent, or Firm* — Daniel A. Tallitsch;
Baker McKenzie LLP

(30) **Foreign Application Priority Data**
Dec. 14, 2016 (CH) 142927
(51) **LOC (11) Cl.** **19-06**
(52) **U.S. Cl.**
USPC **D19/168**
(58) **Field of Classification Search**
USPC D19/115–123, 161–179; D14/411;
D27/101; D7/635, 636, 637, 642;
D28/76, 85
CPC B43K 7/005; B43K 7/00; B43K 8/003;
B43K 5/005; B43K 21/006
See application file for complete search history.

(57) **CLAIM**

The ornamental design for a pen, as shown and described.

DESCRIPTION

- 1. Pen
- 1.1 : Perspective
- 1.2 : Right
- 1.3 : Left
- 1.4 : Front
- 1.5 : Back
- 1.6 : Bottom
- 1.7 : Top

The portions of the pen shown by grey coloring form no part of the claimed design.

1 Claim, 4 Drawing Sheets

(56) **References Cited**
U.S. PATENT DOCUMENTS
D656,989 S * 4/2012 Briggl D14/480.3
D697,915 S * 1/2014 Lien D14/411
D700,238 S * 2/2014 Slemp D19/172
D708,263 S * 7/2014 Laemle D19/179

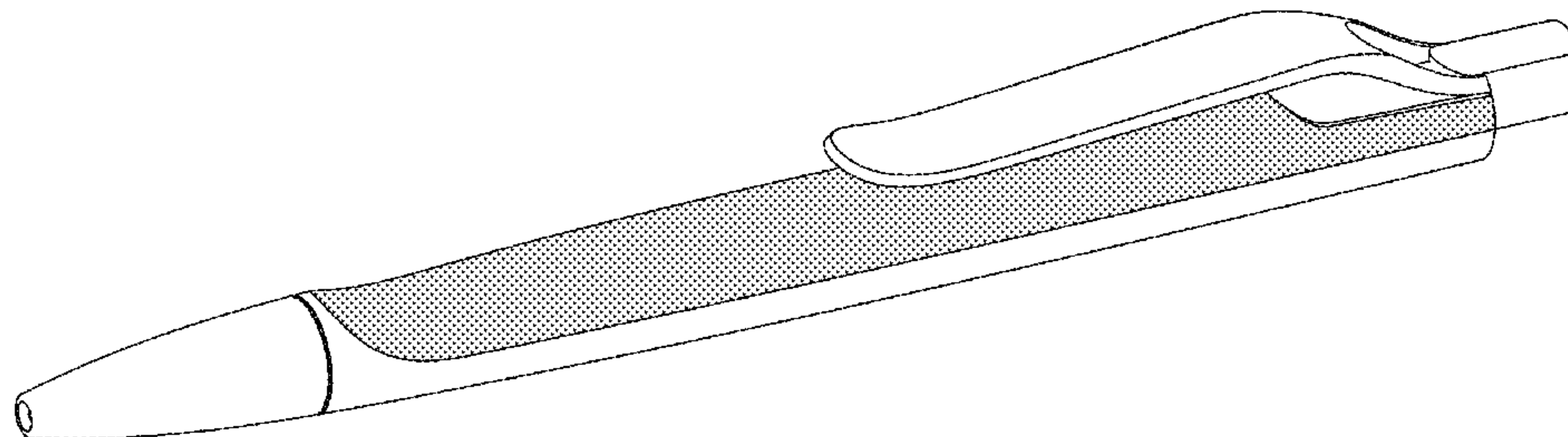

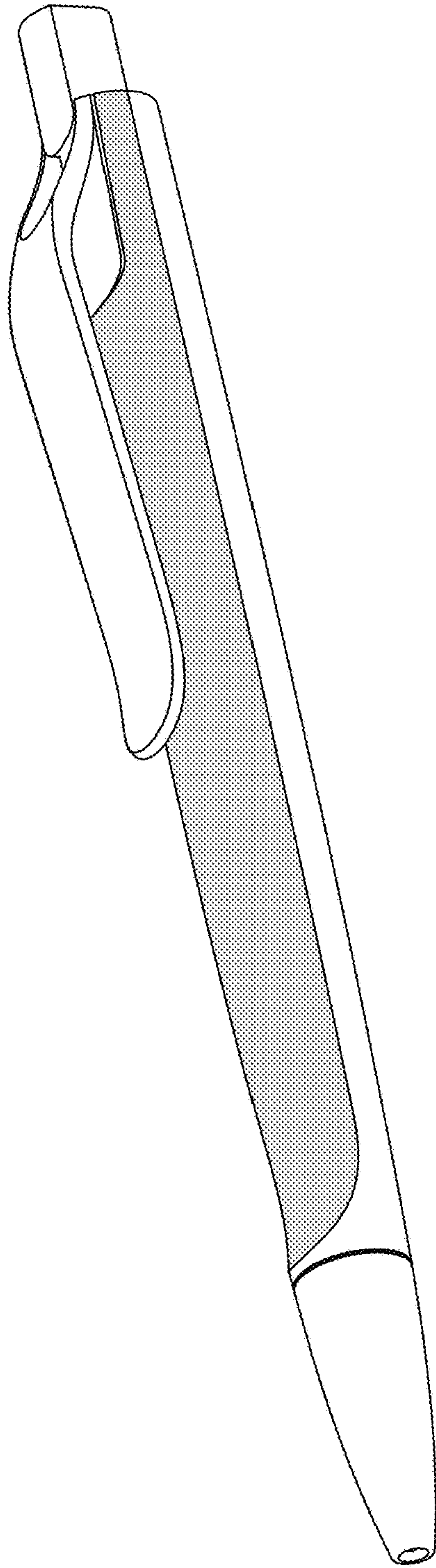

1.1

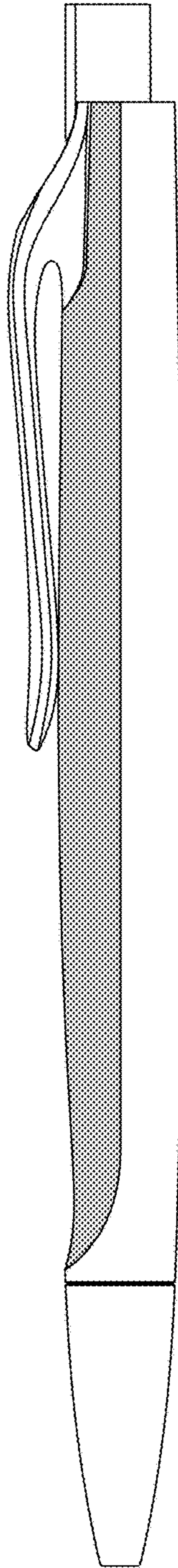

1.2

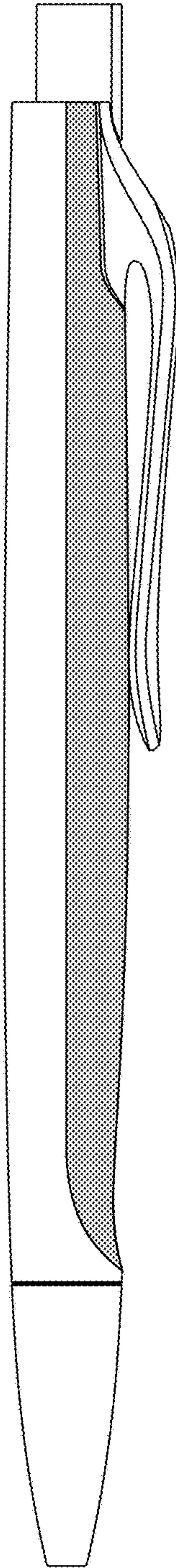

1.3

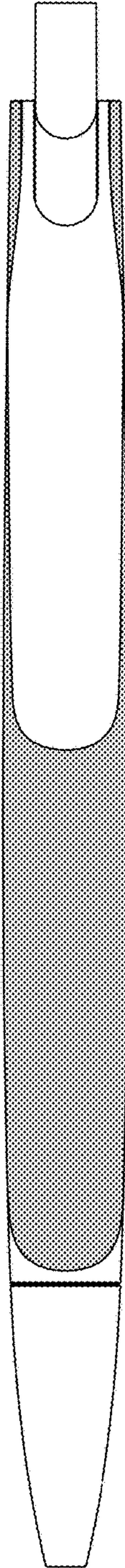

1.4



1.5

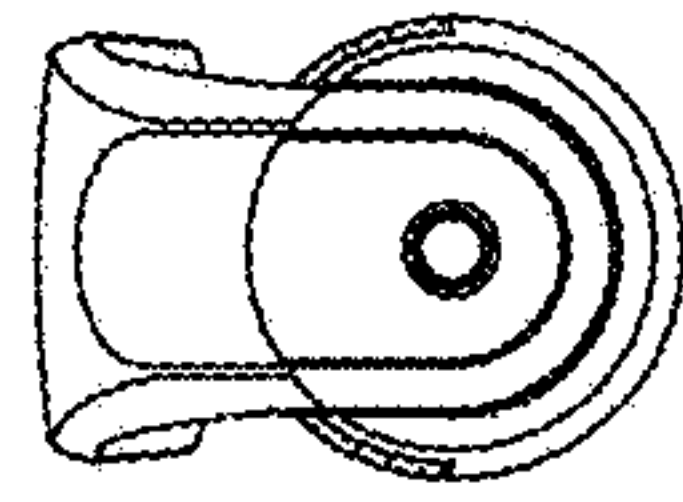

1.7

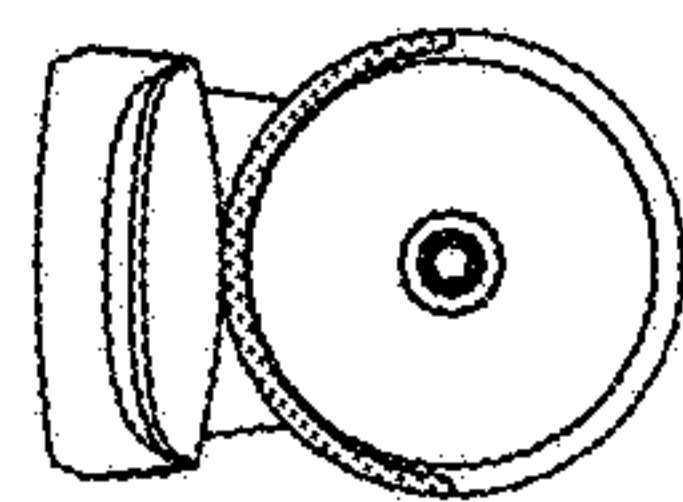

1.6