



US00D838758S

(12) **United States Design Patent** (10) **Patent No.:** **US D838,758 S**
Kymm et al. (45) **Date of Patent:** **** Jan. 22, 2019**

(54) **HOUSEHOLD ROBOT**

- (71) Applicant: **LG ELECTRONICS INC.**, Seoul (KR)
- (72) Inventors: **Sangwook Kymm**, Seoul (KR); **Hongyoul Choi**, Seoul (KR); **Jaekwang Bahn**, Seoul (KR); **Sangjun Koo**, Seoul (KR); **Hana Kim**, Seoul (KR)
- (73) Assignee: **LG ELECTRONICS INC.**, Seoul (KR)
- (**) Term: **15 Years**

- (21) Appl. No.: **29/586,233**
- (22) Filed: **Dec. 1, 2016**
- (51) **LOC (11) Cl.** **15-99**
- (52) **U.S. Cl.**
USPC **D15/199**; D21/578
- (58) **Field of Classification Search**
USPC D15/199, 144; D21/578, 579, 576, D21/621-623, 624-627, 630; D24/185; D14/302, 307; D10/15, 6-8, 23
CPC . B25J 9/044; B25J 9/003; B25J 9/0078; B25J 9/102; B25J 18/00; B25J 18/002; B25J 18/04; B25J 18/007; B25J 15/00; B25J 15/0033; B25J 15/0038
See application file for complete search history.

(56) **References Cited**

U.S. PATENT DOCUMENTS

D600,569 S *	9/2009	Sadler	D10/15
D624,610 S *	9/2010	Wu	D21/578
D636,445 S *	4/2011	Avery	D14/172
D640,142 S *	6/2011	Bedol	D10/15
D685,438 S *	7/2013	Fan	D15/199
D710,953 S *	8/2014	Katsutani	D15/199
D719,621 S *	12/2014	Song	D21/578
D761,894 S *	7/2016	Ho	D15/199
D765,180 S *	8/2016	Huang	D20/5

OTHER PUBLICATIONS

ExtremeTech, Meet Jibo, the world's first family robot, posted Jul. 16, 2014, [online], [site visited May 17, 2018]. Available from Internet, <URL: <https://www.extremetech.com/extreme/186401-meet-jibo-the-worlds-first-family-robot-made-by-mits-social-robotics-master>> (Year: 2014).*

CNN, Helping 'smart' devices talk to each other, posted Mar. 28, 2014, [online], [site visited May 17, 2018]. Available from Internet, <URL: <https://www.cnn.com/2014/03/28/tech/innovation/smart-device-communication/index.html>> (Year: 2014).*

Blue Birds and Butterflies, Russian Doll Measuring Cups, posted Apr. 13, 2011, [online], [site visited May 23, 2018]. Available from Internet, <URL: <http://bluebirdsandbutterflies.typepad.com/bluebirds-and-butterflies/2011/04/russian-doll-measuring-cups.html>> (Year: 2011).*

* cited by examiner

Primary Examiner — Sheryl Lane

Assistant Examiner — Samantha N Wood

(74) *Attorney, Agent, or Firm* — Birch, Stewart, Kolasch & Birch, LLP

(57) **CLAIM**

The ornamental design for a household robot, as shown and described.

DESCRIPTION

FIG. 1 is a front, right side, perspective view of a household robot showing our new design;
 FIG. 2 is a front view thereof;
 FIG. 3 is a rear view thereof;
 FIG. 4 is a left side view thereof;
 FIG. 5 is a right side view thereof;
 FIG. 6 is a top view thereof; and,
 FIG. 7 is a bottom view.
 The broken lines shown in FIG. 7 depict portions of the household robot that form no part of the claimed design.

1 Claim, 6 Drawing Sheets

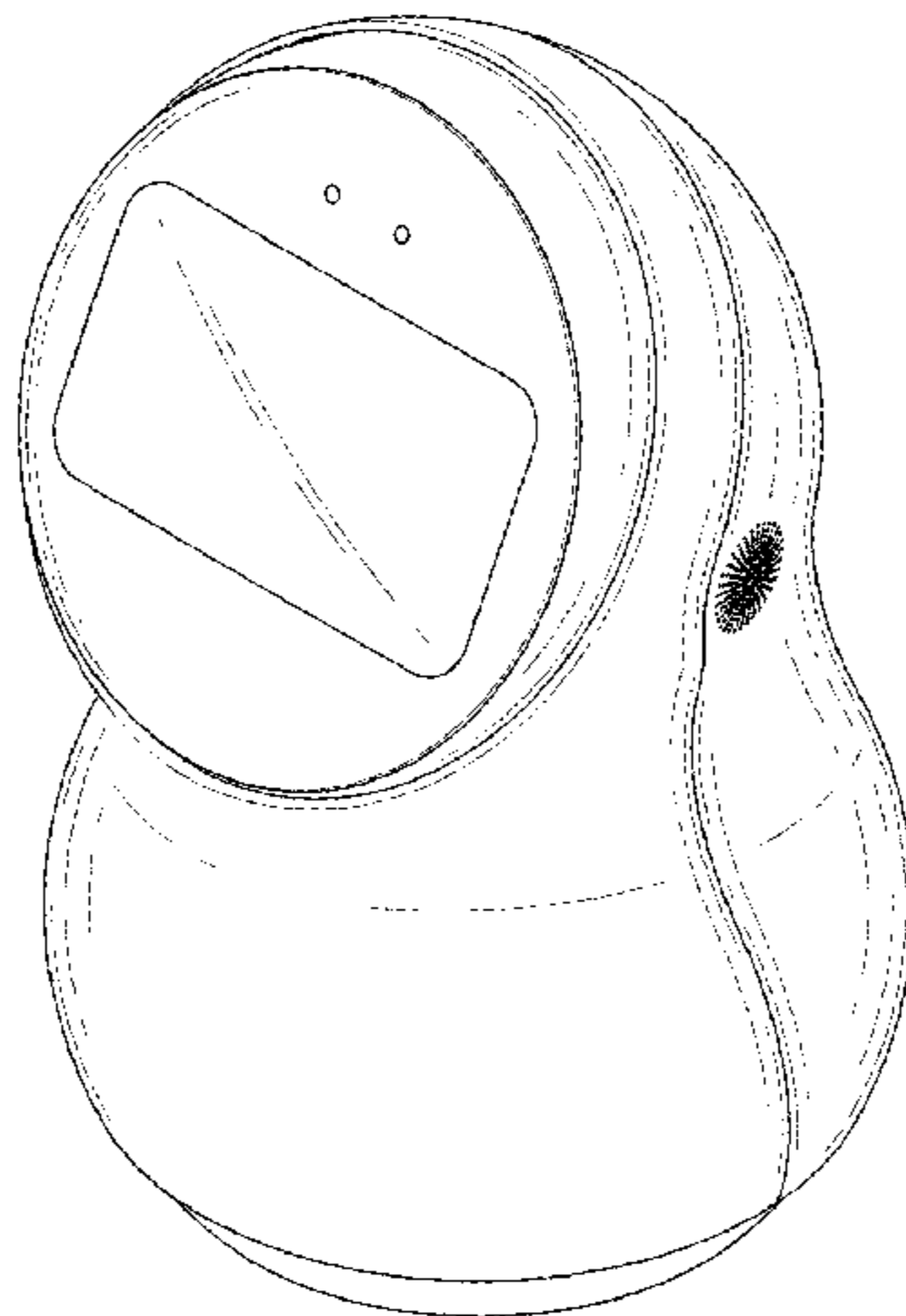

FIG. 1

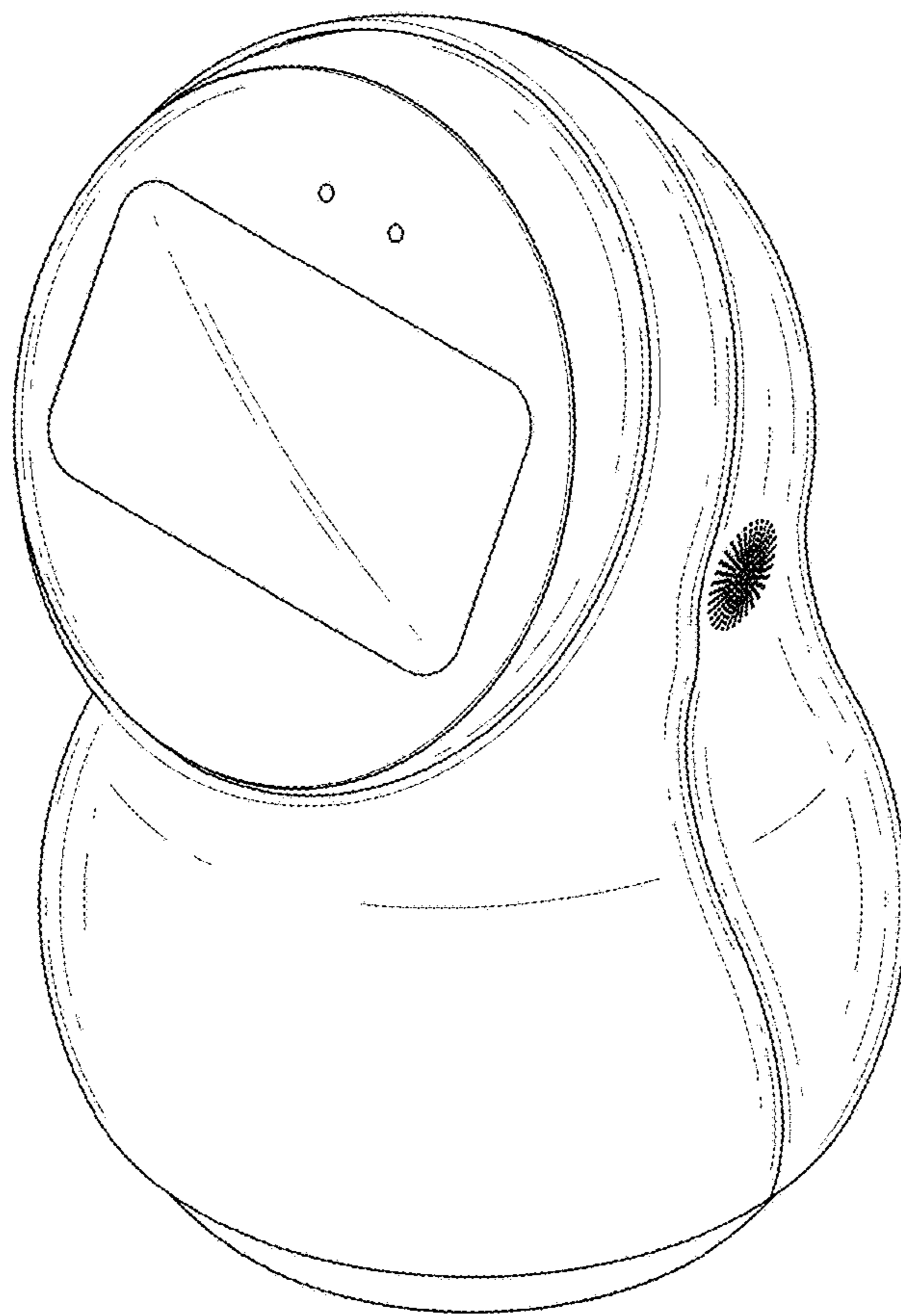

FIG. 2

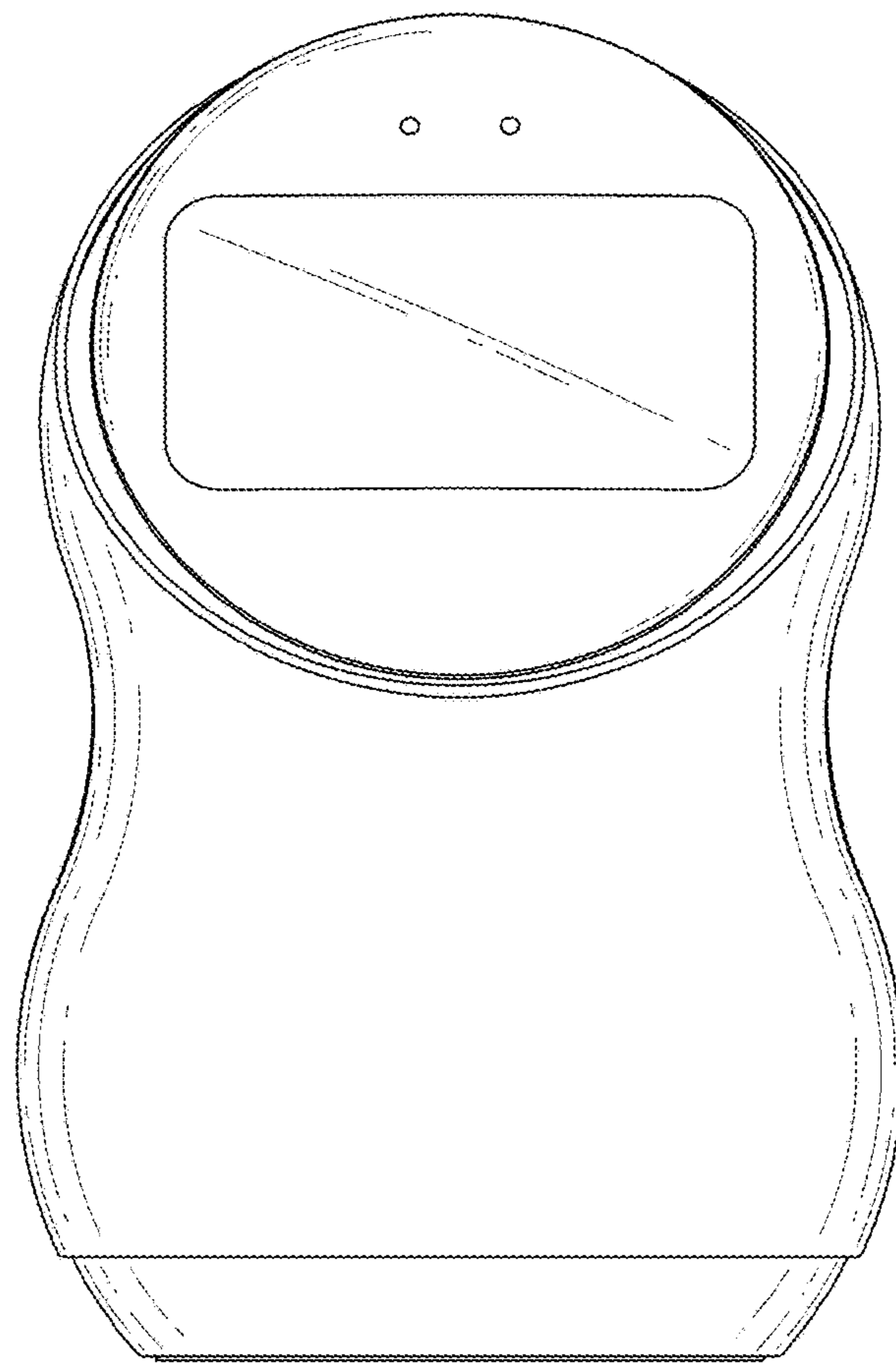

FIG. 3

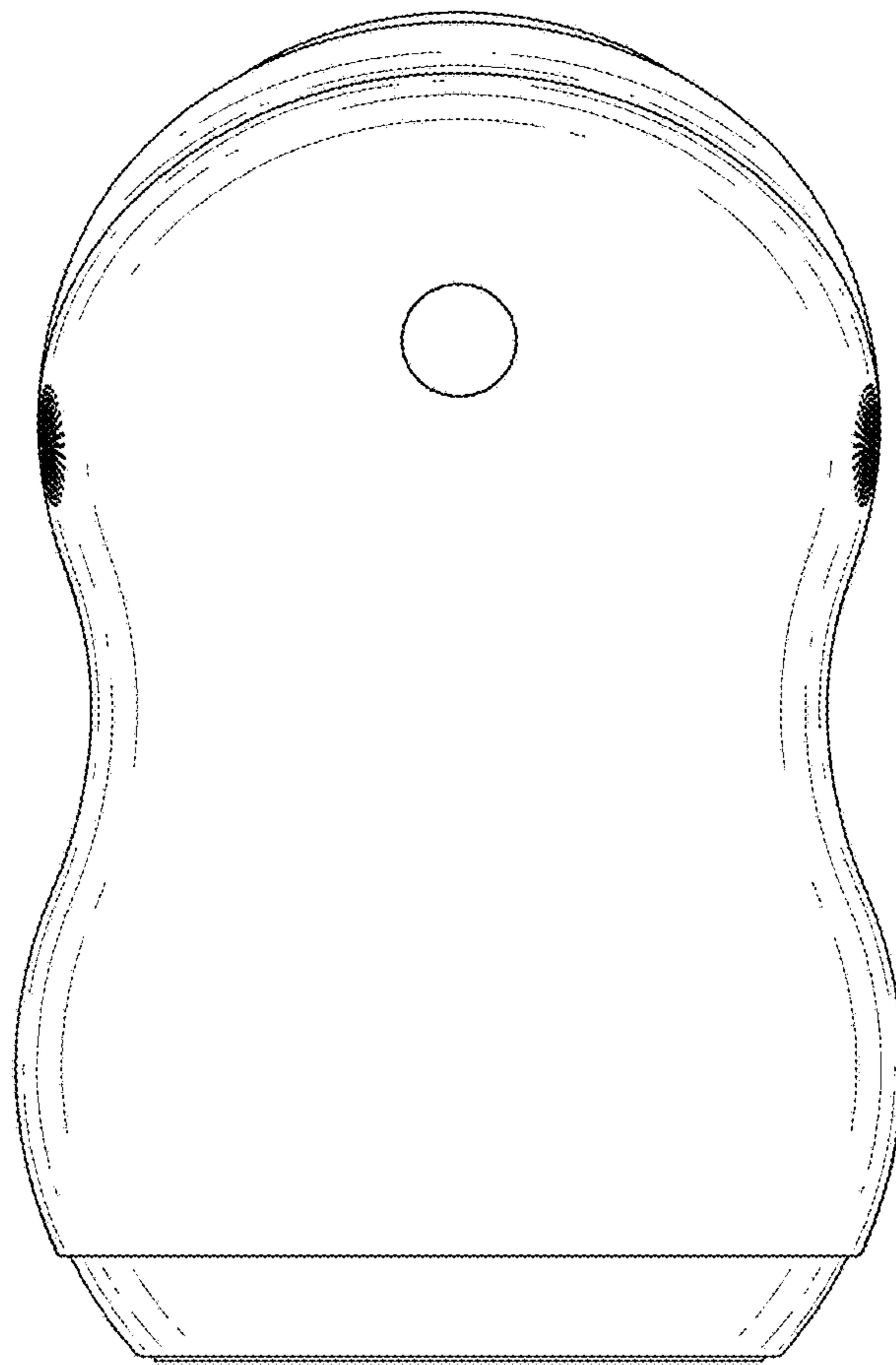

FIG. 4

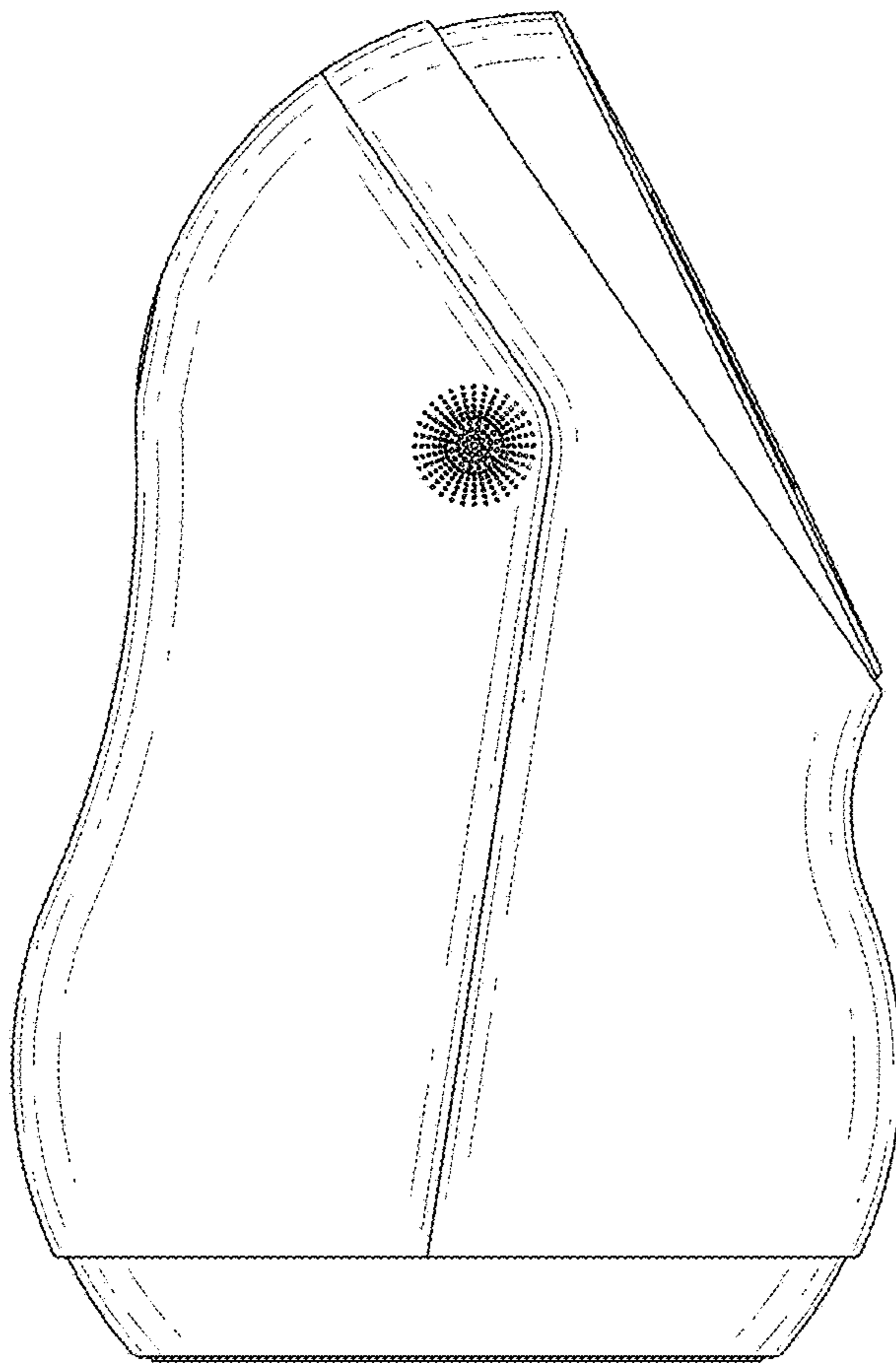

FIG. 5

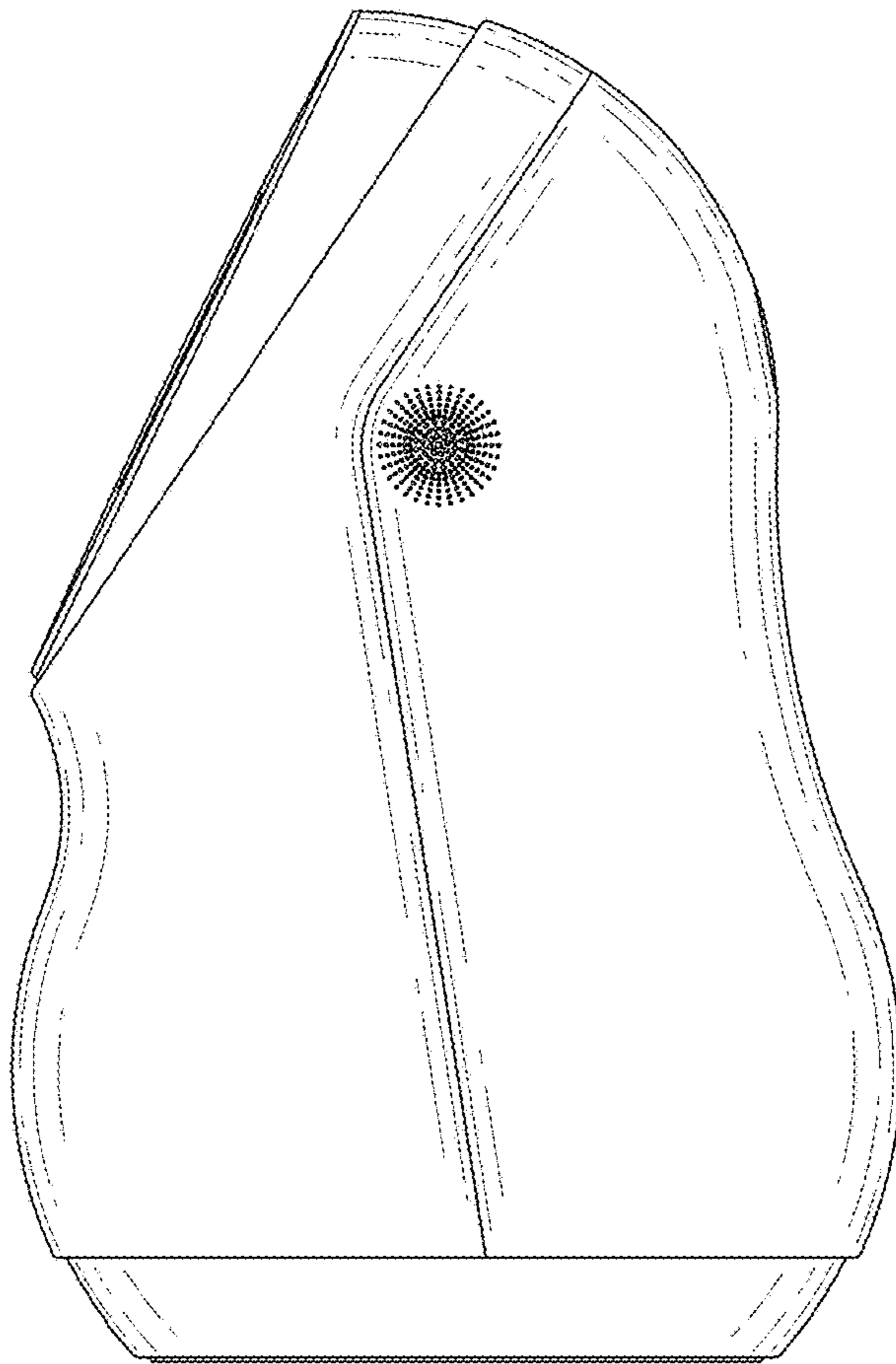

FIG. 6

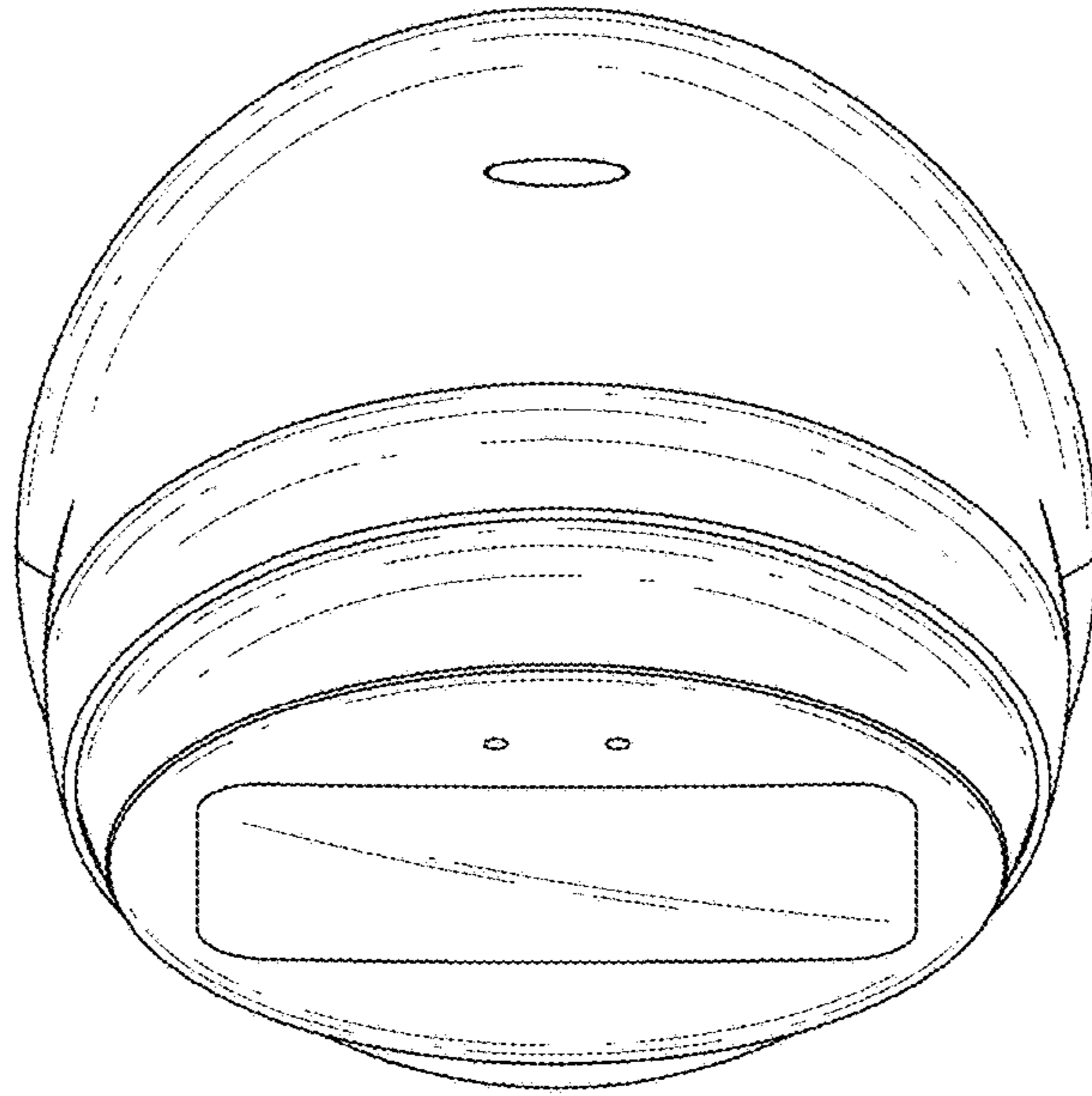

FIG. 7

