



US00D838691S

(12) **United States Design Patent** (10) **Patent No.:** **US D838,691 S**
Petty et al. (45) **Date of Patent:** **** Jan. 22, 2019**

(54) **CONTROL PANEL**

(71) Applicant: **BLACKMAGIC DESIGN PTY LTD**,
 Port Melbourne (AU)

(72) Inventors: **Grant Petty**, Port Melbourne (AU);
Simon Kidd, Port Melbourne (AU);
Shannon Smith, Port Melbourne (AU);
Stuart Elford, Port Melbourne (AU);
Andrew Howley, Port Melbourne
 (AU); **John Vanzella**, Port Melbourne
 (AU); **Luca Abate**, Port Melbourne
 (AU); **Ying Shao**, Port Melbourne (AU)

(73) Assignee: **Blackmagic Design Pty Ltd** (AU)

(**) Term: **15 Years**

(21) Appl. No.: **29/608,646**

(22) Filed: **Jun. 23, 2017**

(30) **Foreign Application Priority Data**

Dec. 23, 2016 (EM) 003537224

(51) **LOC (11) Cl.** **14-03**

(52) **U.S. Cl.**
 USPC **D14/217; D14/496; D14/203.1**

(58) **Field of Classification Search**

USPC D14/496, 401, 435, 474, 483, 217, 137,
 D14/138, 160, 168, 356, 203.1–203.8,
 D14/507; 345/156, 169, 173–179, 905;
 715/727–729, 864; 710/1, 5, 8; 713/1,
 713/600; 455/1.1, 1.7, 73, 344–347, 93,
 455/95, 3.01–3.06, 550.1, 573.1;
 370/342–344; 369/1, 2, 6–12;
 463/43–47; 273/148 B; D13/162–164
 CPC G06F 1/1656; G06F 1/1632; G06F 3/02;
 G06F 3/041; G06F 3/0213; H04R 3/00;
 H04R 2420/01

See application file for complete search history.

(56) **References Cited**

U.S. PATENT DOCUMENTS

D508,918 S * 8/2005 Ritchey D14/457
 D588,590 S * 3/2009 Tompkin D14/247
 D607,425 S * 1/2010 Asai D14/125
 D609,220 S * 2/2010 Ito D14/217
 D615,993 S * 5/2010 Ho D14/203.1
 D616,868 S * 6/2010 Ito D14/217
 7,821,781 B2 * 10/2010 Adenau H05B 37/029
 361/679.11

(Continued)

OTHER PUBLICATIONS

Blackmagic Design Pty Ltd, digital photos of control panel, angle view and front view, ATEM 1ME Broadcast Panel, released Apr. 11, 2011.

(Continued)

Primary Examiner — Keli L Hill

(74) *Attorney, Agent, or Firm* — Saidman DesignLaw Group, LLC

(57) **CLAIM**

The ornamental design for a control panel, as shown and described.

DESCRIPTION

FIG. 1 is a front perspective view of a control panel showing our new design;
 FIG. 2 is a rear perspective view thereof;
 FIG. 3 is a front view thereof;
 FIG. 4 is a rear view thereof;
 FIG. 5 is a top view thereof;
 FIG. 6 is a left side view thereof; and,
 FIG. 7 is a right side view thereof.
 The broken lines illustrate structure or features which form no part of the claimed design.
 The drawings include surface shading which represents contour and not surface ornamentation.

1 Claim, 7 Drawing Sheets

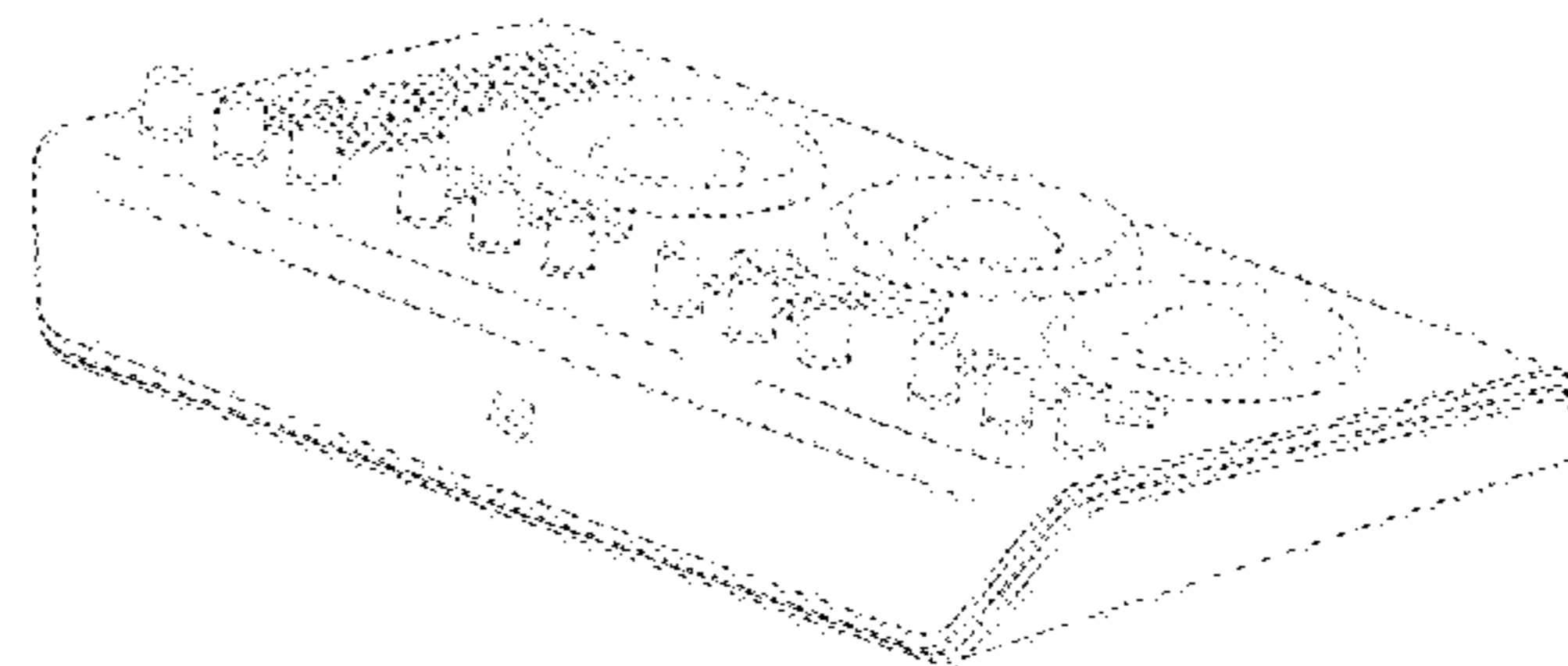
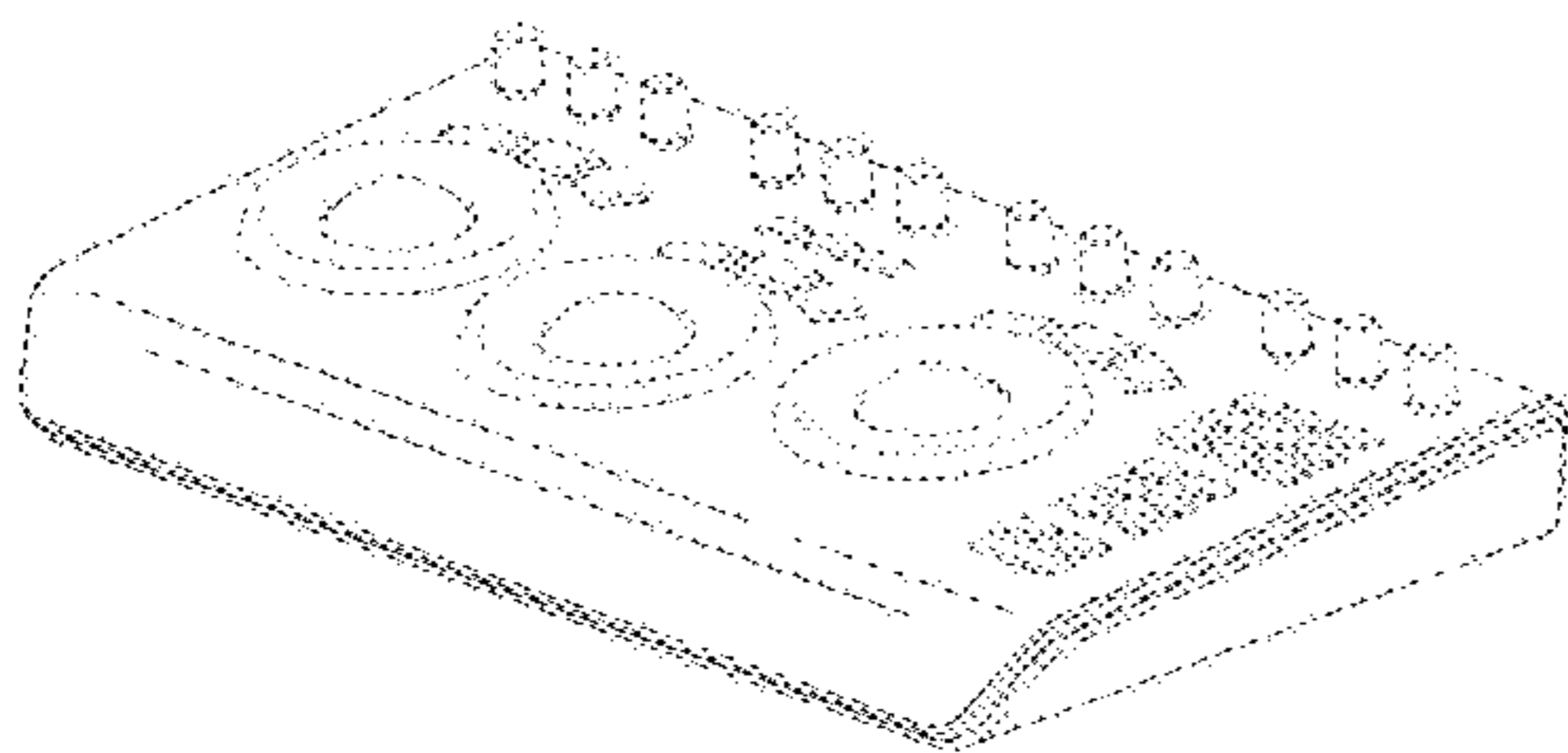

(56)

References Cited

U.S. PATENT DOCUMENTS

D631,062 S * 1/2011 Bennett D14/496
8,138,689 B2 * 3/2012 Adenau H05B 37/0254
315/292
D666,159 S * 8/2012 Adenau D13/164
D680,519 S * 4/2013 Ito D14/217
D791,187 S * 7/2017 Ito D14/496
9,824,672 B2 * 11/2017 Ludwig G10H 1/32

OTHER PUBLICATIONS

Blackmagic Design Pty Ltd, digital photo of control panel, angle view, ATEM 2ME Broadcast Panel, released 2011.

Blackmagic Design Pty Ltd, digital photo of control panel, angle view, DaVinci Resolve Panel, released 2010.

U.S. Appl. No. 29/608,642, filed Jun. 23, 2017 (unpublished).

U.S. Appl. No. 29/608,643, filed Jun. 23, 2017 (unpublished).

U.S. Appl. No. 29/608,645, filed Jun. 23, 2017 (unpublished).

* cited by examiner

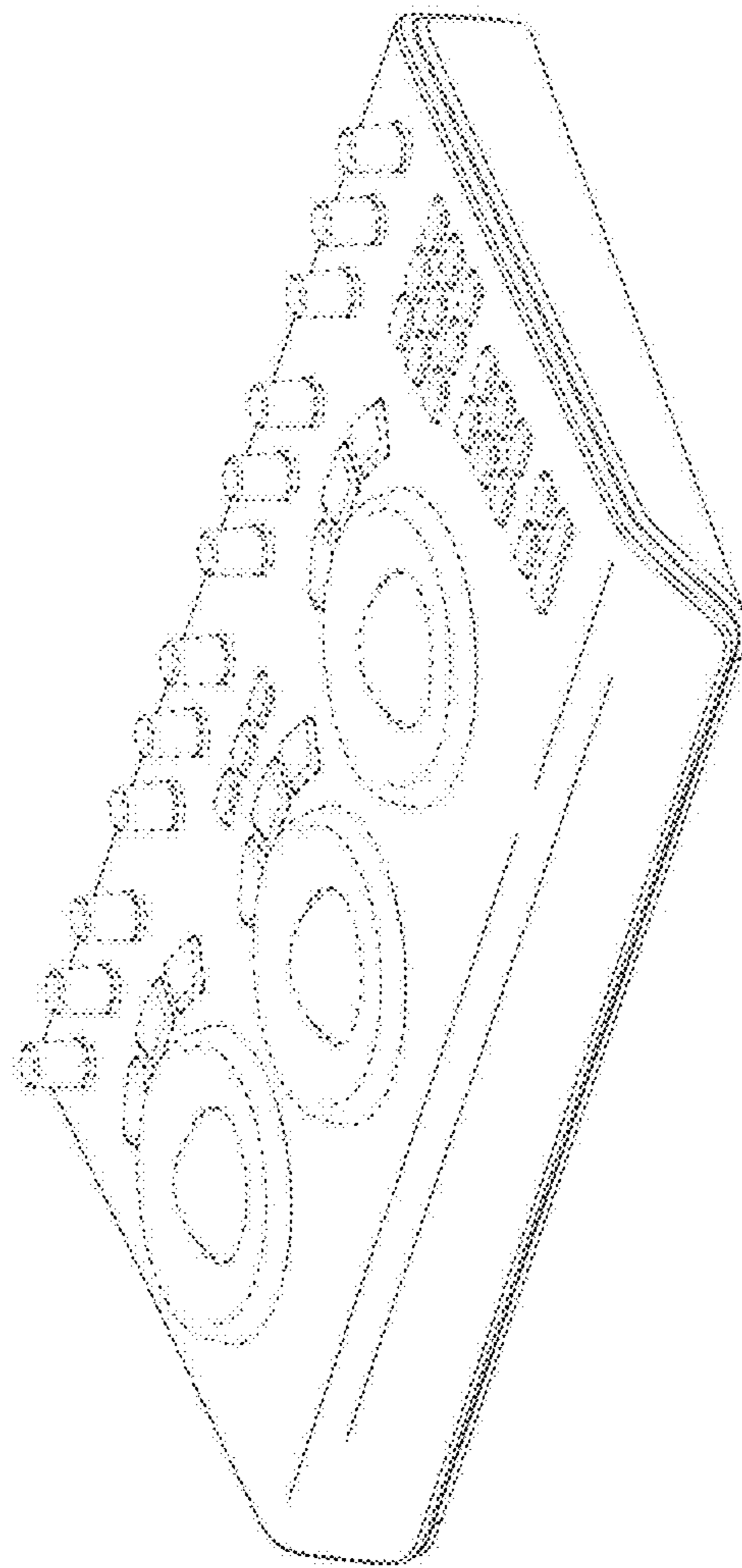

FIG. 1

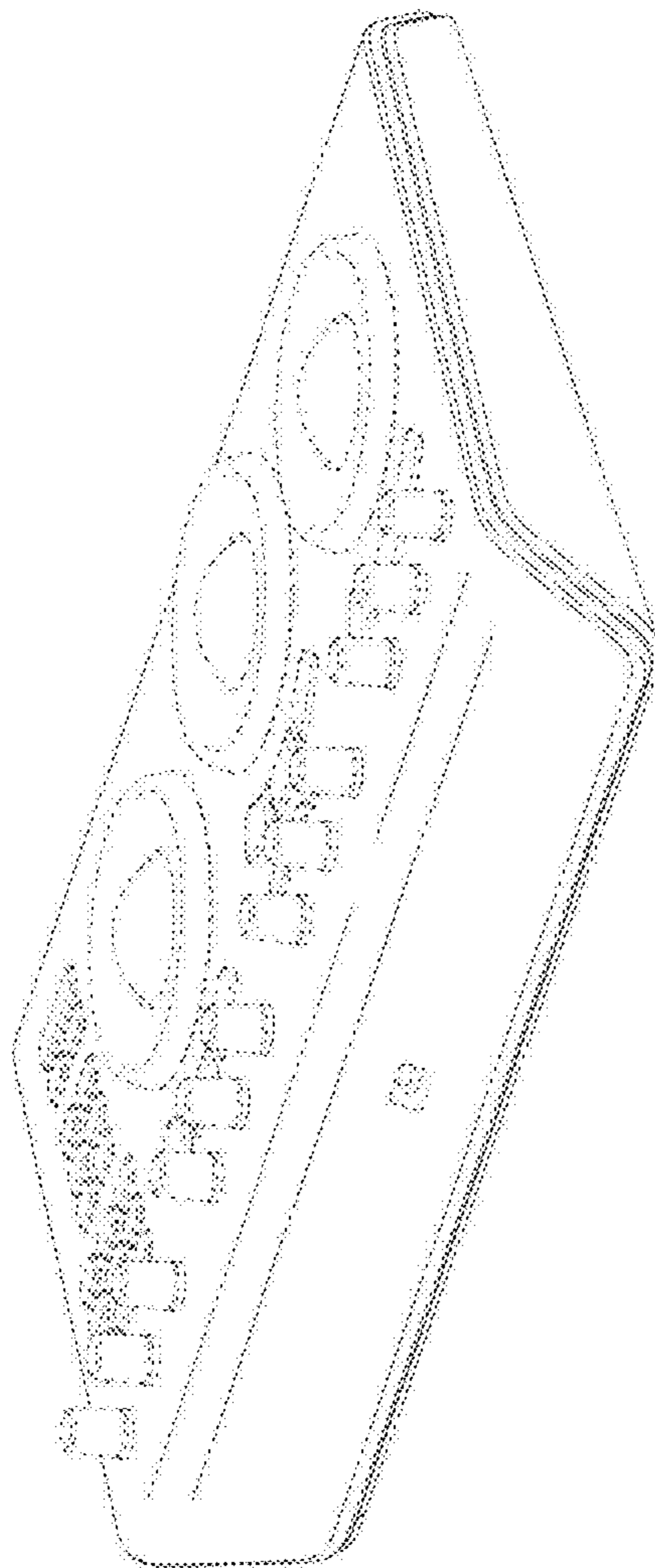

FIG. 2

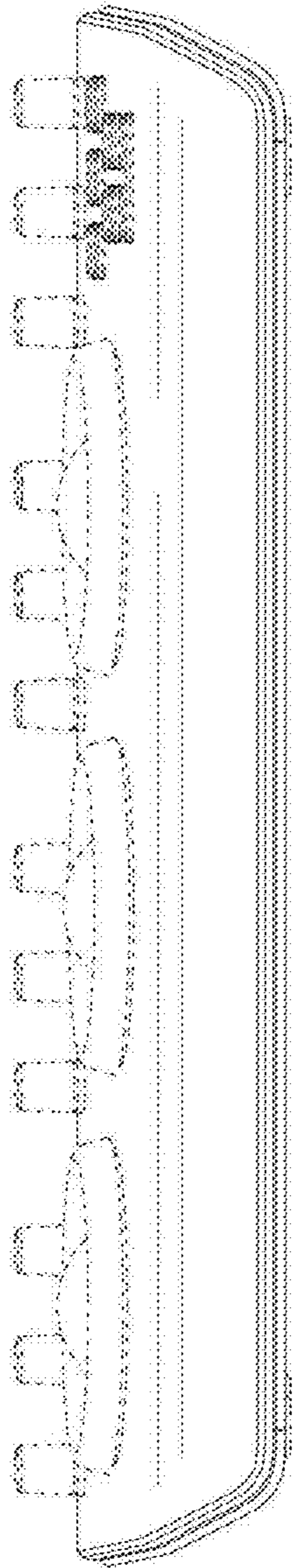

FIG. 3

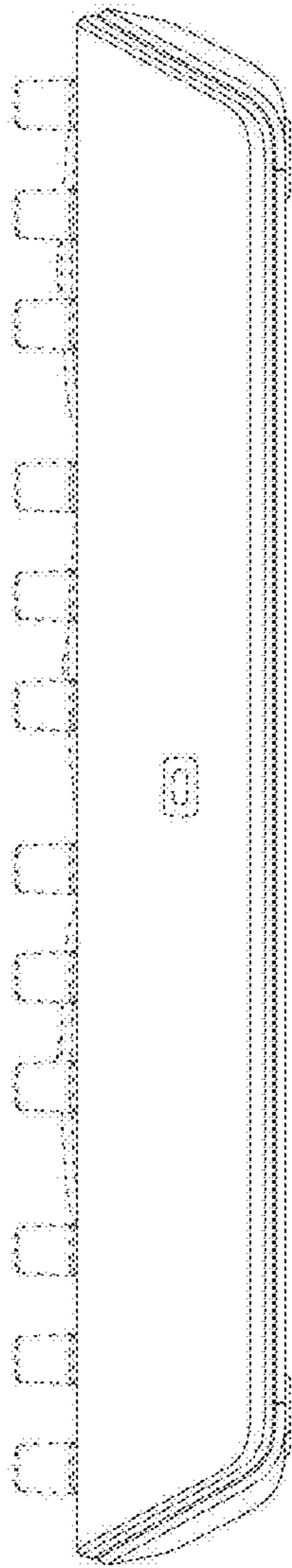

FIG. 4

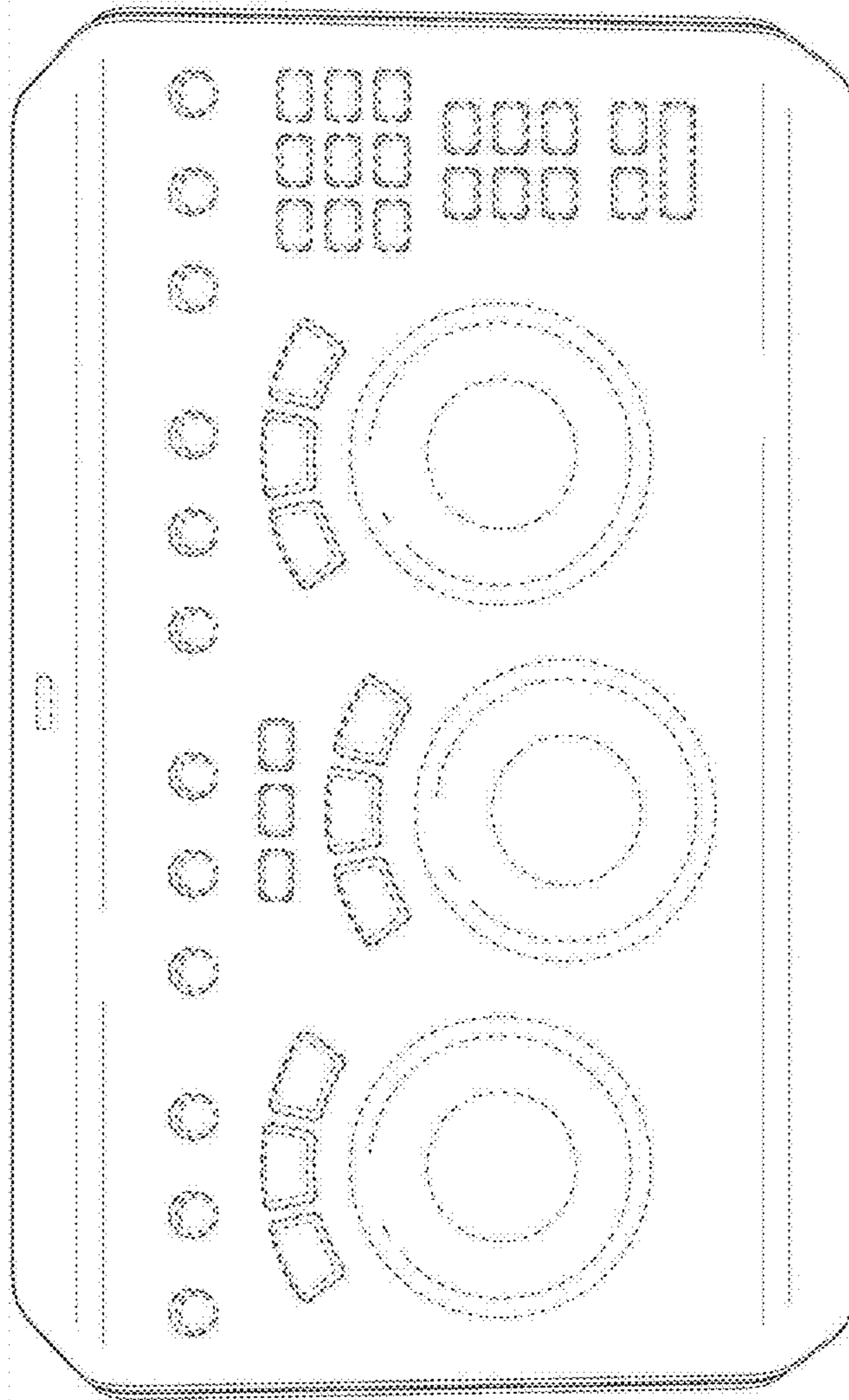

FIG. 5

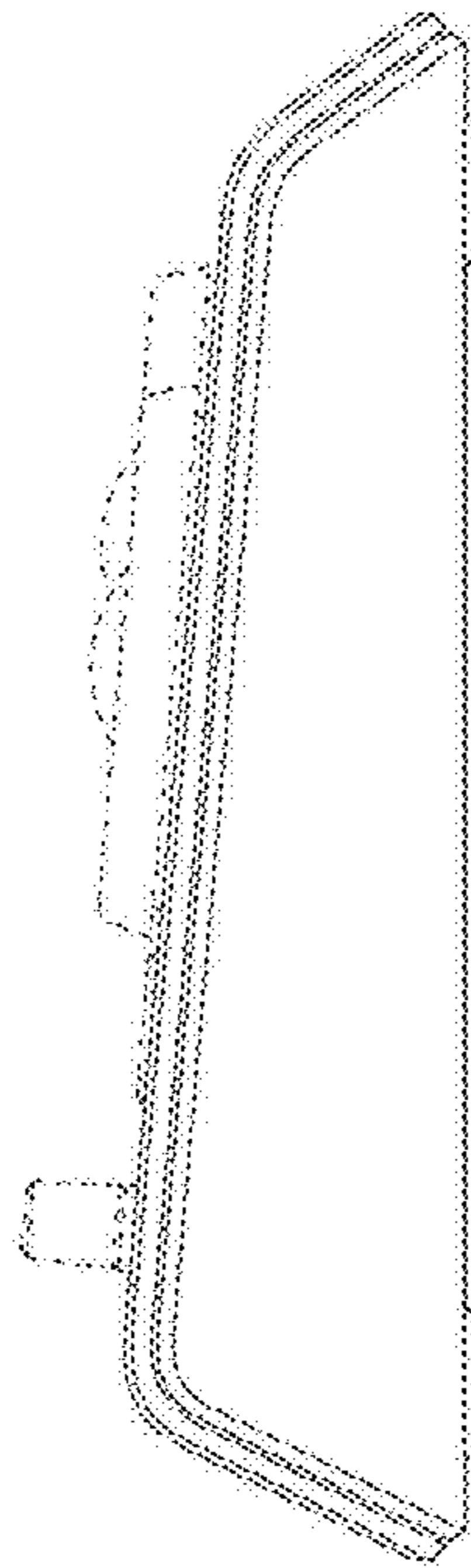

FIG. 6

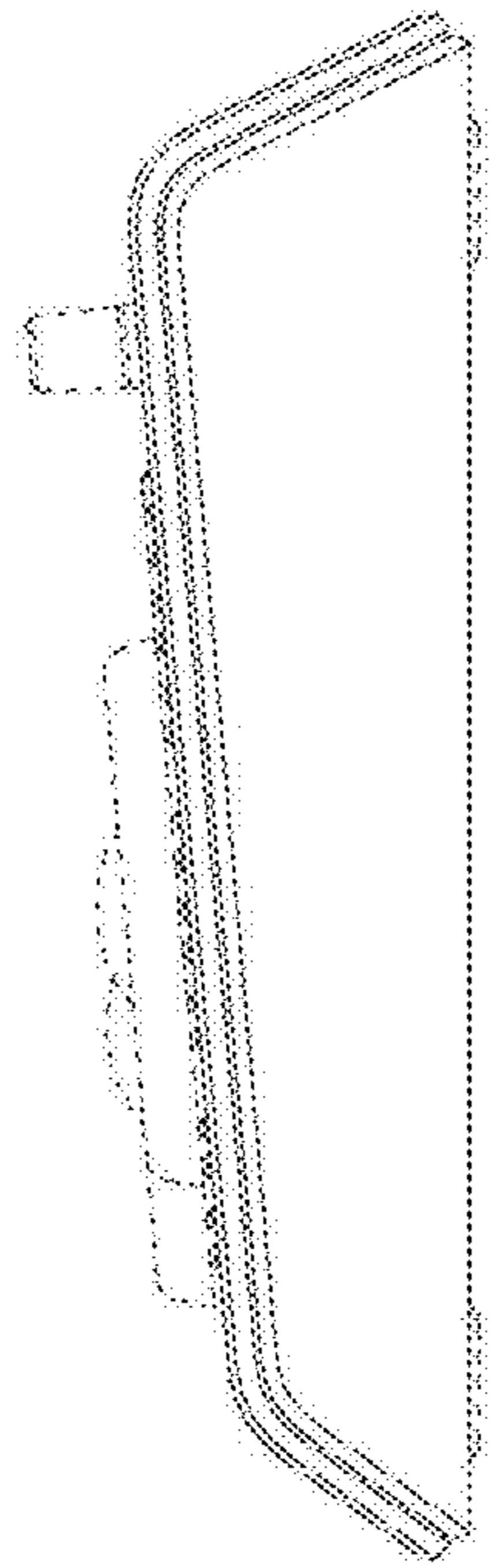

FIG. 7