



US00D838492S

(12) **United States Design Patent**  
**Gardner**

(10) **Patent No.:** **US D838,492 S**

(45) **Date of Patent:** **\*\* Jan. 22, 2019**

(54) **COMBINED SHOE BRUSH MITTEN AND BAG**

(71) Applicant: **Don L. Gardner**, Washington, DC (US)

(72) Inventor: **Don L. Gardner**, Washington, DC (US)

(\*\*) Term: **15 Years**

(21) Appl. No.: **29/651,009**

(22) Filed: **Oct. 16, 2017**

(51) **LOC (11) Cl.** ..... **04-99**

(52) **U.S. Cl.**  
USPC ..... **D4/116; D4/130; D2/614; D9/706; D9/720**

(58) **Field of Classification Search**  
USPC ..... D4/116, 118, 119, 130, 134, 136, 137, D4/199; D3/200; D28/63, 64.1, 64.2, D28/64.3; D2/622, 614; D32/42; D9/703, 705, 706, 720  
CPC ..... A45D 24/14; A45D 24/16; A46B 3/005; A46B 5/00; A46B 5/02; A46B 5/021; A46B 9/02; A46B 9/021; A46B 9/023; A46B 13/001; A46B 13/008; A46B 15/0055; A46B 15/0081; A46B 15/0087; A46B 17/02; A46B 2200/30; A46B 2200/104; A46B 2200/106; A46B 2200/202; A46B 2200/205; A46B 2200/207; A46B

(Continued)

(56) **References Cited**

**U.S. PATENT DOCUMENTS**

D28,239 S \* 2/1898 Millhiser ..... D27/185  
1,469,029 A \* 9/1923 Underwood ..... A41D 19/0068  
15/227

(Continued)

*Primary Examiner* — Keli L Hill  
*Assistant Examiner* — Karra S Johnson

(57) **CLAIM**

The ornamental design for a combined shoe brush mitten and bag, as shown and described.

**DESCRIPTION**

FIG. 1 is a perspective view for a combined shoe brush mitten and bag showing an exposed interior side thereof shown in a shoe brush mitten mode;  
FIG. 2 is a right side view of the combined shoe brush mitten and bag shown in FIG. 1;  
FIG. 3 is an end view of the combined shoe brush mitten and bag shown in FIG. 1 and showing a closed end thereof;  
FIG. 4 is a left side view of the combined shoe brush mitten and bag shown in FIG. 1;  
FIG. 5 is an opposite end view of an open end of the combined shoe brush mitten and bag shown in FIG. 1 and showing an open end thereof;  
FIG. 6 is a top view of the combined shoe brush mitten and bag shown in FIG. 1;  
FIG. 7 is a bottom view of the combined shoe brush mitten and bag shown in FIG. 1;  
FIG. 8 is a perspective view of the combined shoe brush mitten and bag showing an exposed exterior side thereof shown in a bag mode.  
FIG. 9 is an end view of the combined shoe brush mitten and bag shown in FIG. 8 and showing a closed end thereof.  
FIG. 10 is an opposite end view of the combined shoe brush mitten and bag shown in FIG. 8 and showing an open end thereof;  
FIG. 11 is a left side view of the combined shoe brush mitten and bag shown in FIG. 8;  
FIG. 12 is a right side view of the combined shoe brush mitten and bag shown in FIG. 8;  
FIG. 13 is a top view of the combined shoe brush mitten and bag shown in FIG. 8; and,  
FIG. 14 is a bottom view of the combined shoe brush mitten and bag shown in FIG. 8.

**1 Claim, 14 Drawing Sheets**

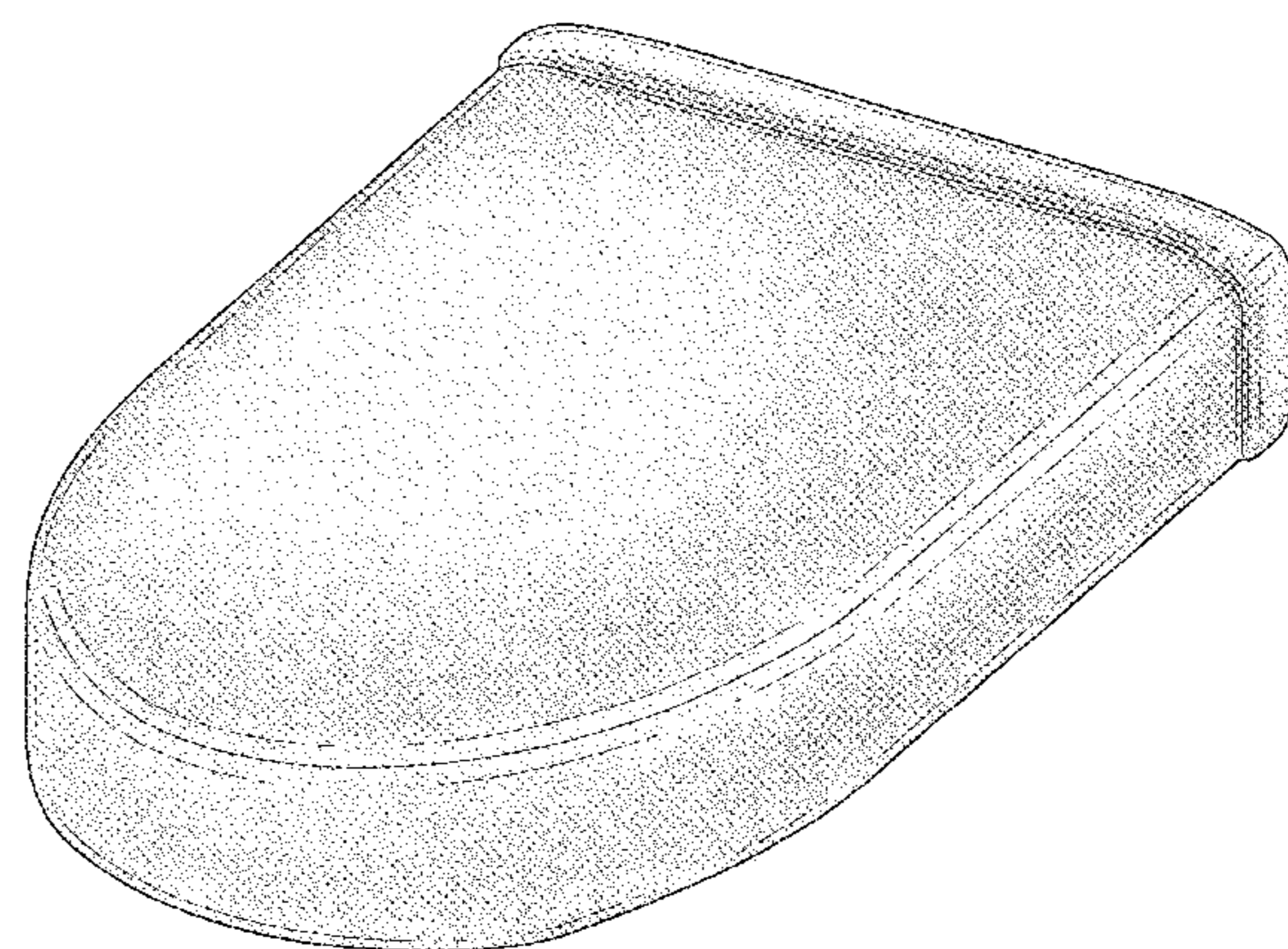
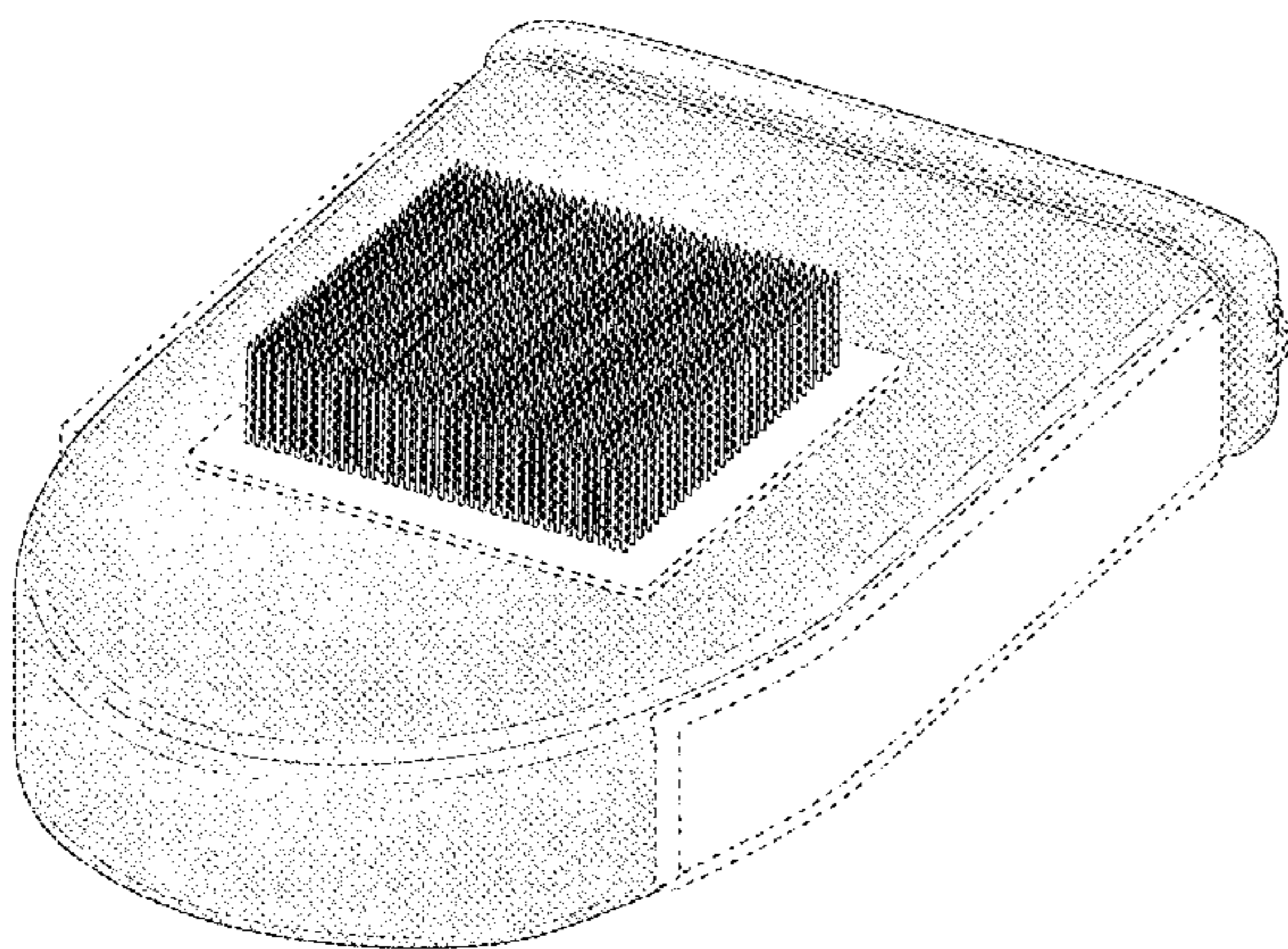

(58) **Field of Classification Search**  
 CPC ..... 2200/304; A46B 2200/1006; A46B  
 2200/1046; A46B 2200/1053; A46B  
 2200/3006; A46B 2200/3033; A46B  
 2200/3093

See application file for complete search history.

(56) **References Cited**

U.S. PATENT DOCUMENTS

1,495,389 A \* 5/1924 Heimerl ..... A47L 13/18  
 15/227  
 2,030,494 A \* 2/1936 Bireley ..... A47L 13/18  
 15/118  
 2,233,686 A \* 3/1941 Topjian ..... A45D 33/34  
 15/227  
 2,279,100 A \* 4/1942 Goldsmith ..... A45D 33/00  
 15/227  
 D206,997 S \* 2/1967 Epstein et al. .... D28/63  
 3,885,249 A \* 5/1975 De Brabander ..... A47L 13/18  
 15/227  
 D268,967 S \* 5/1983 Sami ..... 15/227  
 4,932,095 A \* 6/1990 Kawase ..... A45D 44/00  
 139/396  
 5,050,596 A \* 9/1991 Walasek ..... A41D 19/0068  
 2/158

D363,810 S \* 10/1995 Smith, Jr. .... D28/63  
 D363,965 S \* 11/1995 Guderian ..... 280/809  
 D379,123 S \* 5/1997 Driggers ..... A41D 19/0068  
 15/227  
 D424,783 S \* 5/2000 Meier ..... A46B 17/08  
 134/6  
 6,206,596 B1 \* 3/2001 Johnson ..... A47K 7/03  
 401/201  
 D511,233 S \* 11/2005 Franco ..... D30/162  
 D571,042 S \* 6/2008 Moore ..... A47K 7/03  
 401/201  
 D584,464 S \* 1/2009 Suran ..... A41D 19/0068  
 D28/63  
 D632,445 S \* 2/2011 Orezzaoli ..... A45D 44/00  
 139/396  
 D652,183 S \* 1/2012 Hall ..... A47L 13/18  
 D30/162  
 D668,821 S \* 10/2012 Donnelly ..... A47L 13/18  
 D30/158  
 D711,047 S \* 8/2014 Harrison ..... D28/63  
 D711,652 S \* 8/2014 Erickson ..... D3/303  
 9,351,560 B2 \* 5/2016 Tussy ..... B08B 1/002  
 D3/303  
 D799,761 S \* 10/2017 Dia ..... D30/199  
 2002/0179115 A1 \* 12/2002 Alex ..... A46B 17/08  
 134/6

\* cited by examiner

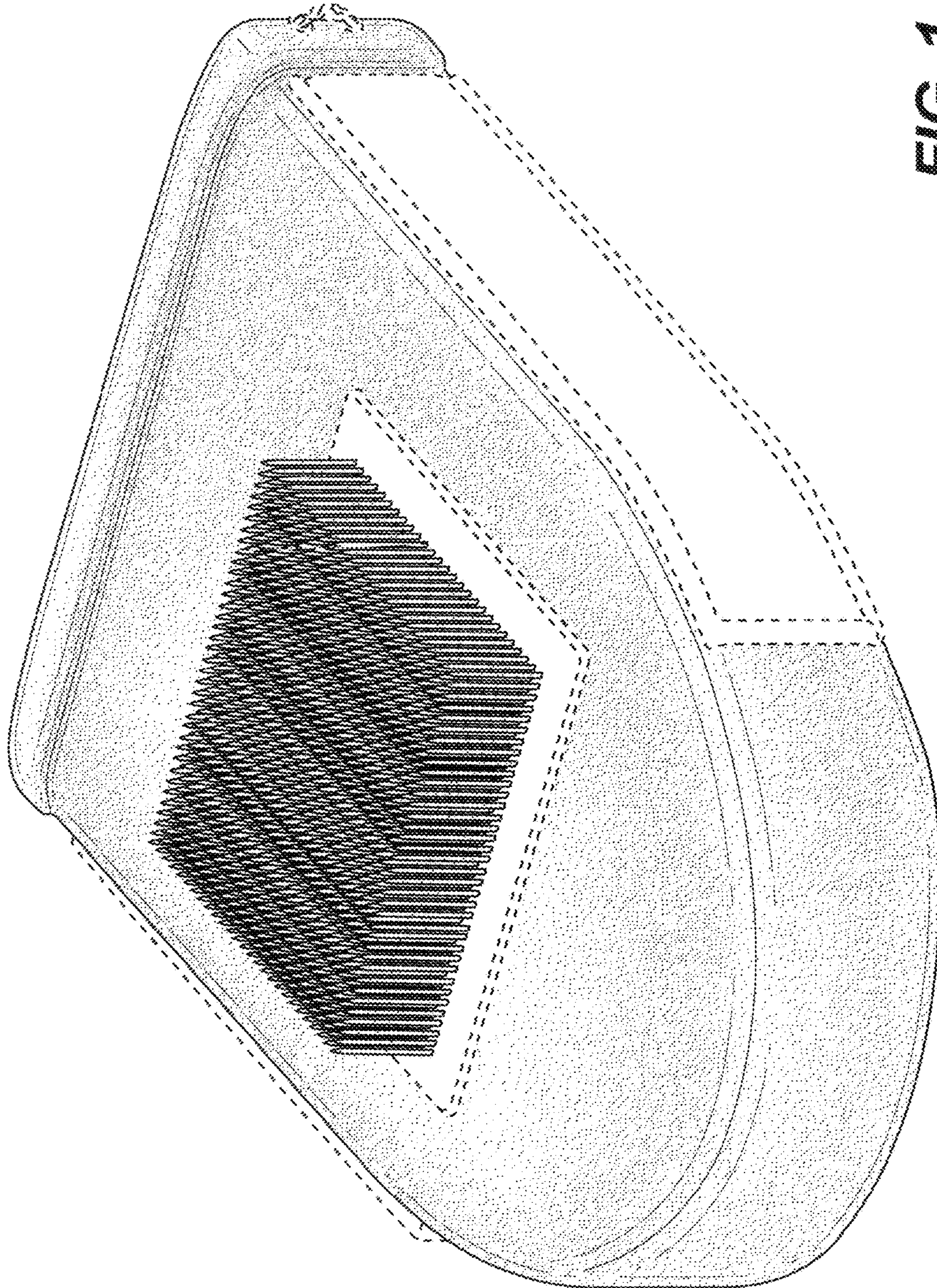
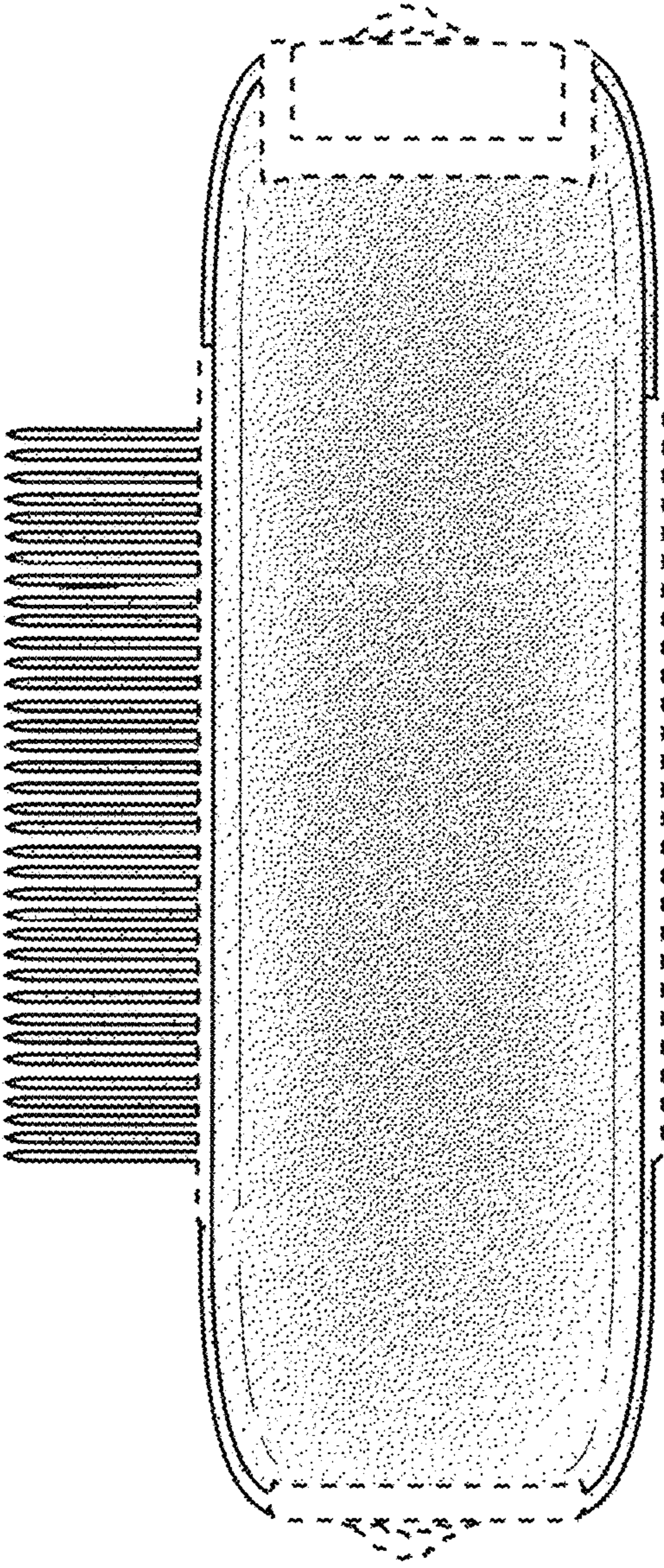
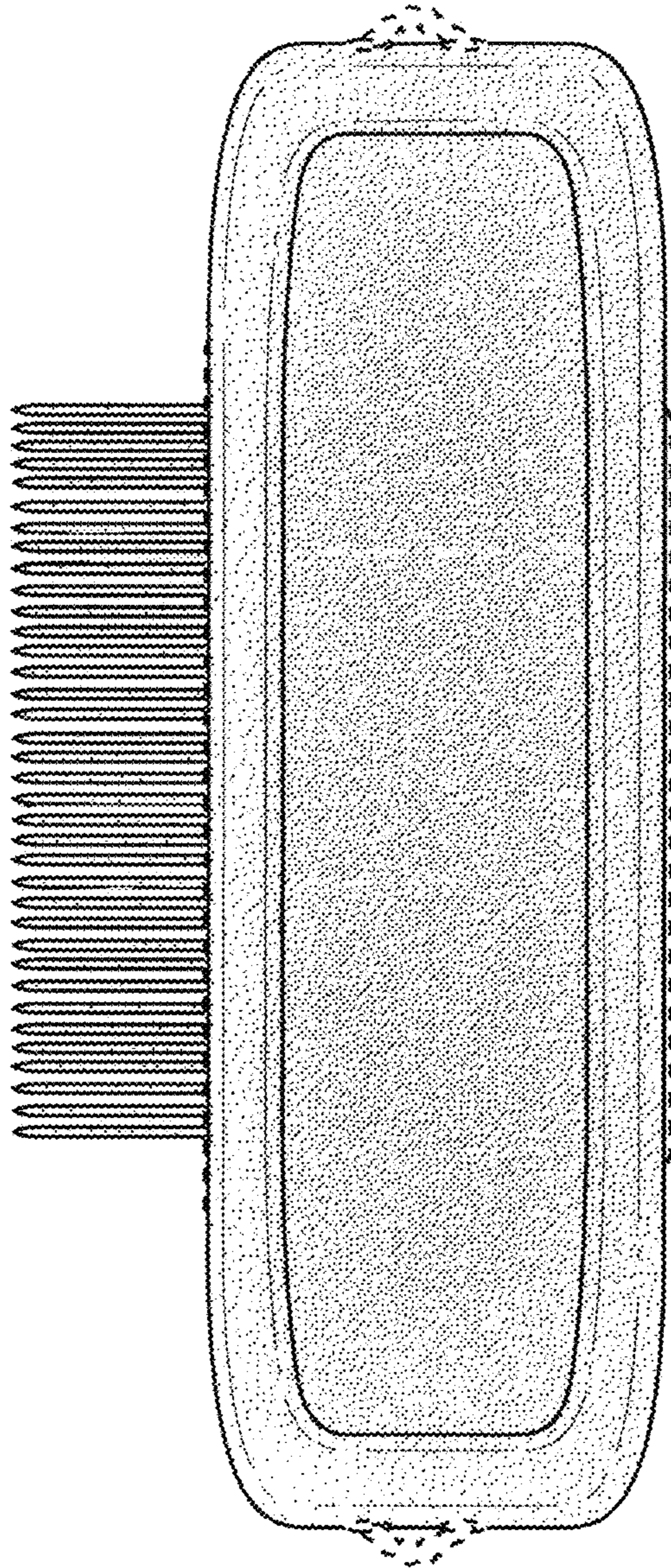

FIG. 1



**FIG. 2**



**FIG. 3**

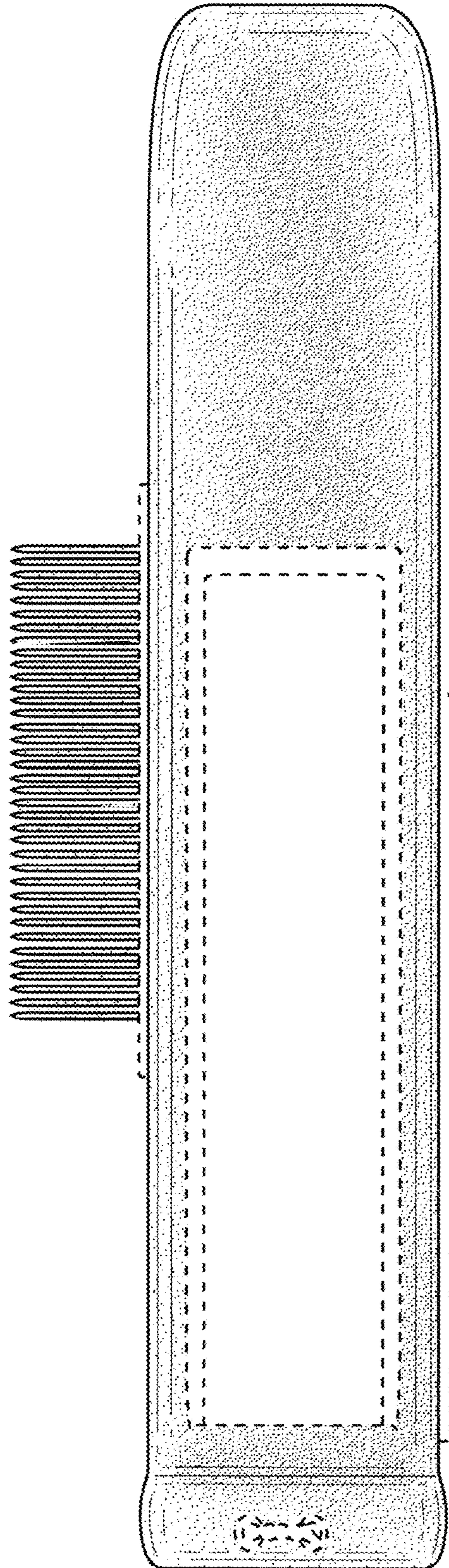

**FIG. 4**

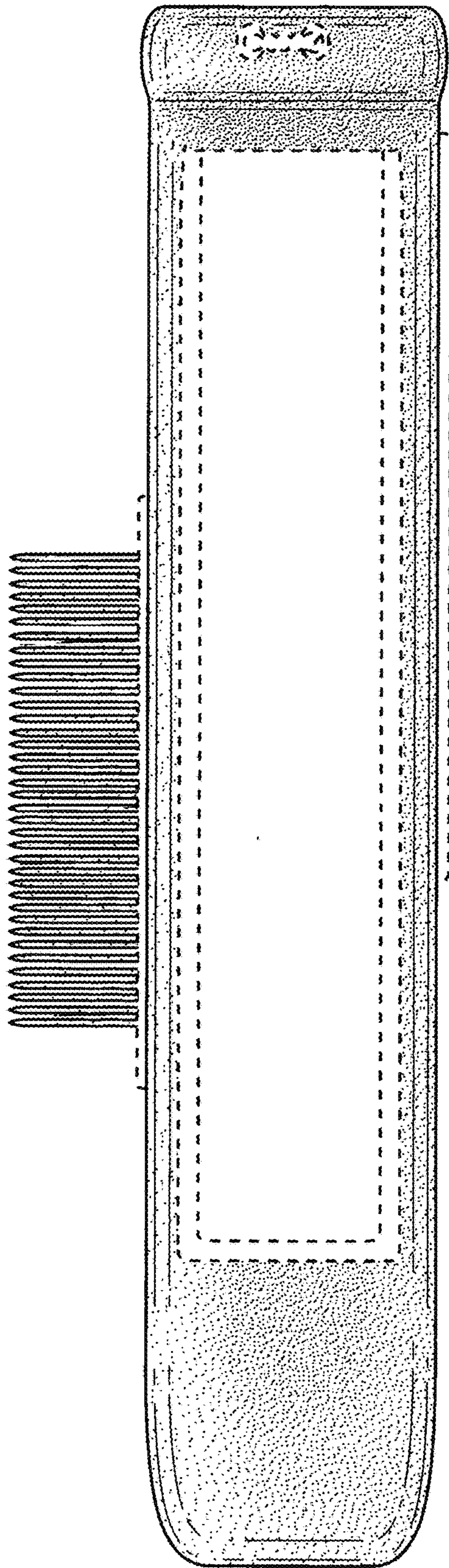

**FIG. 5**

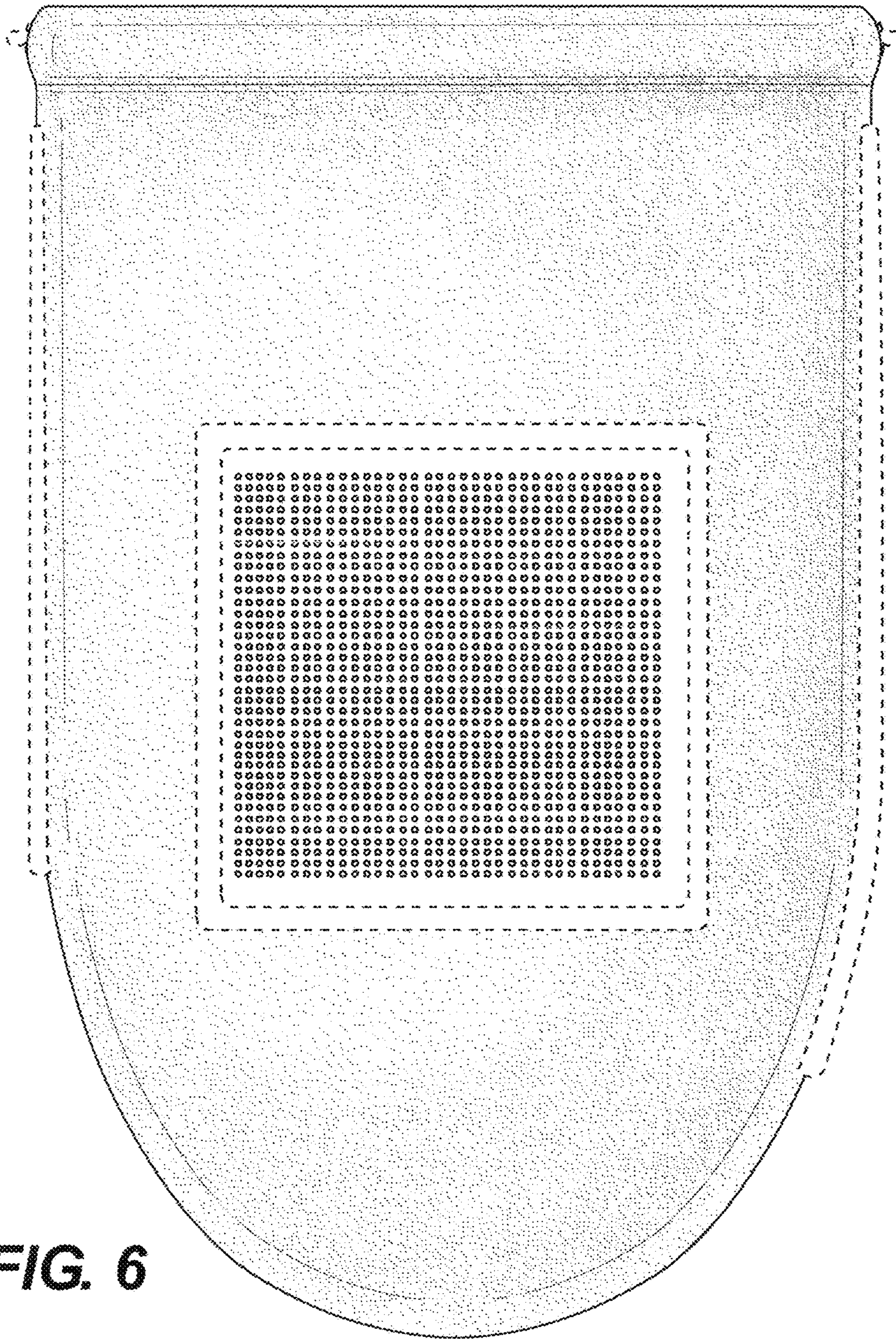

**FIG. 6**



**FIG. 7**

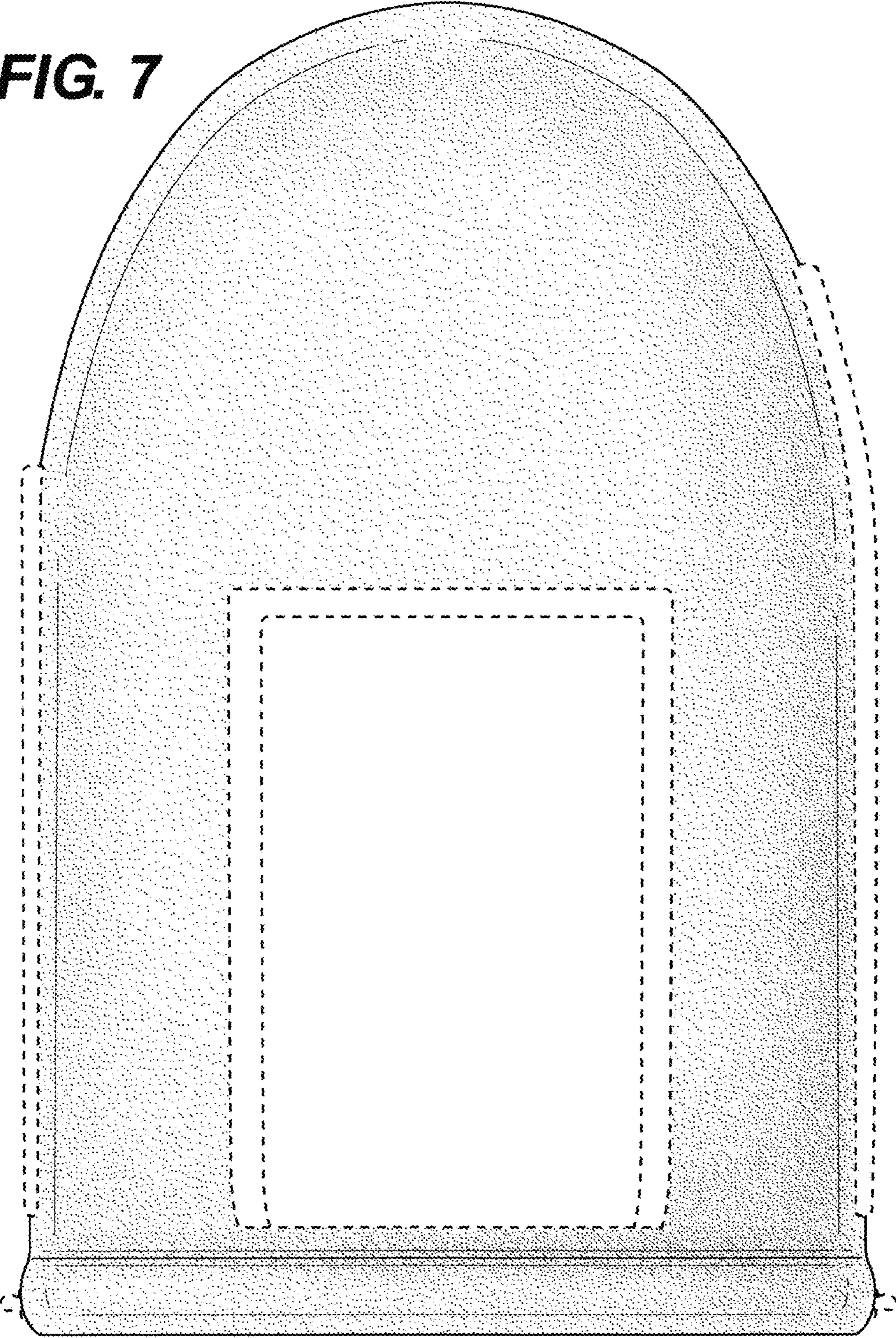

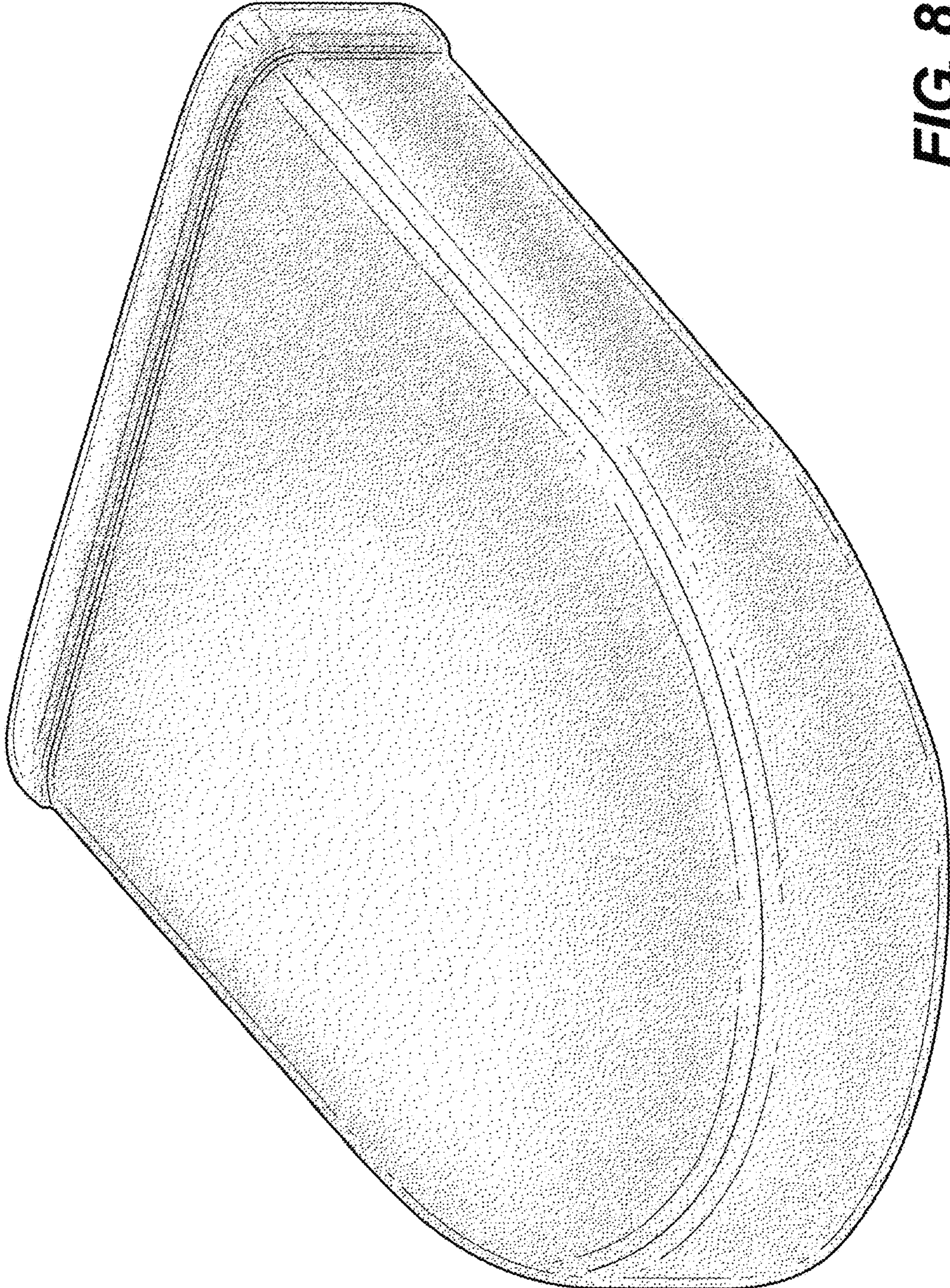
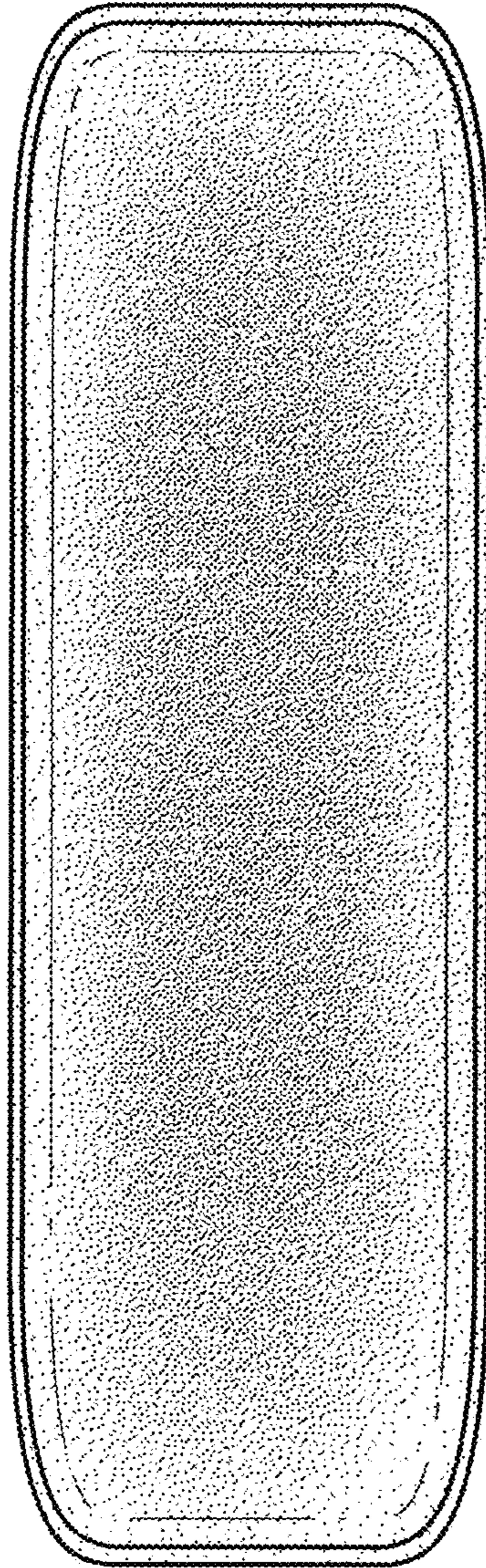
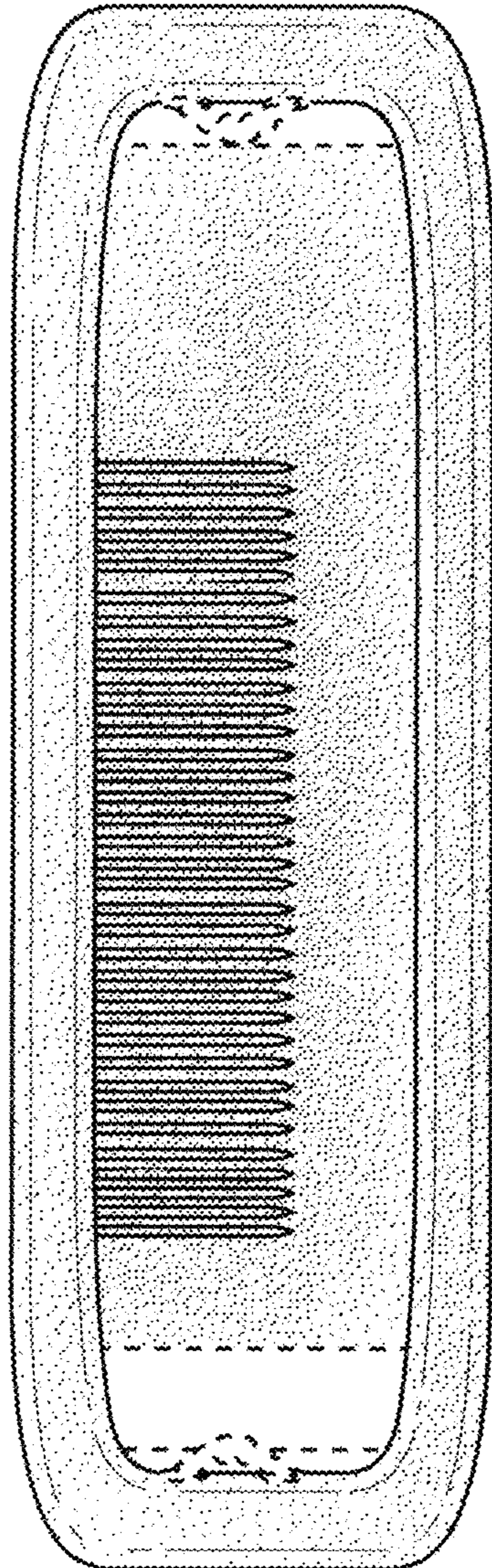

FIG. 8



**FIG. 9**



**FIG. 10**

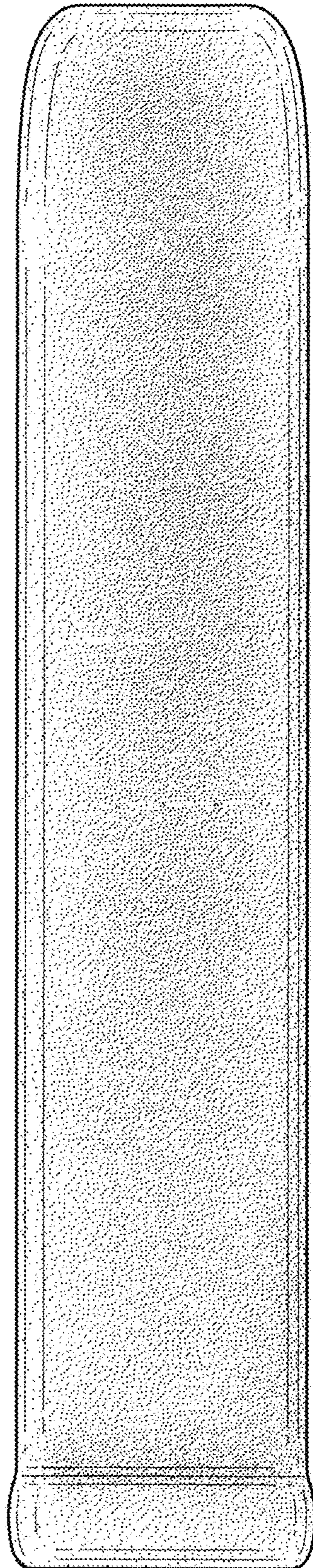

**FIG. 11**

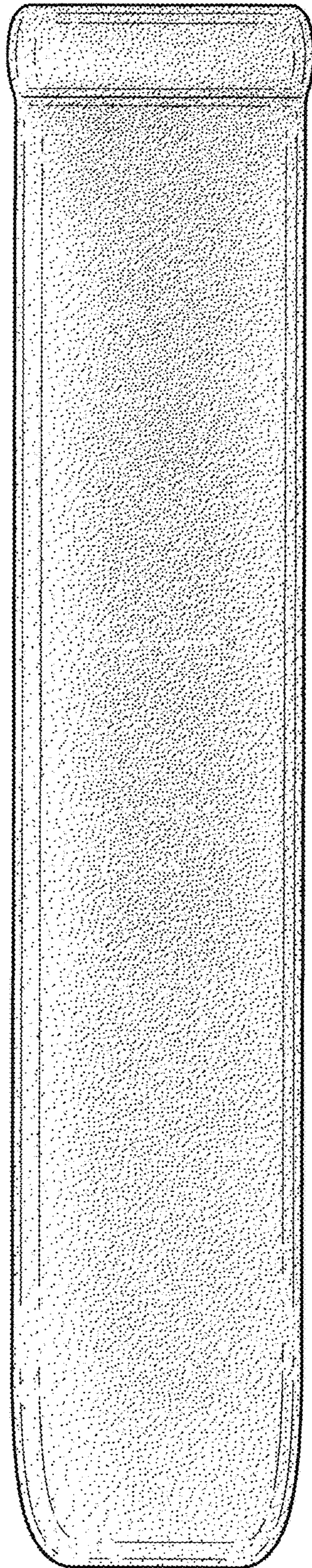

**FIG. 12**

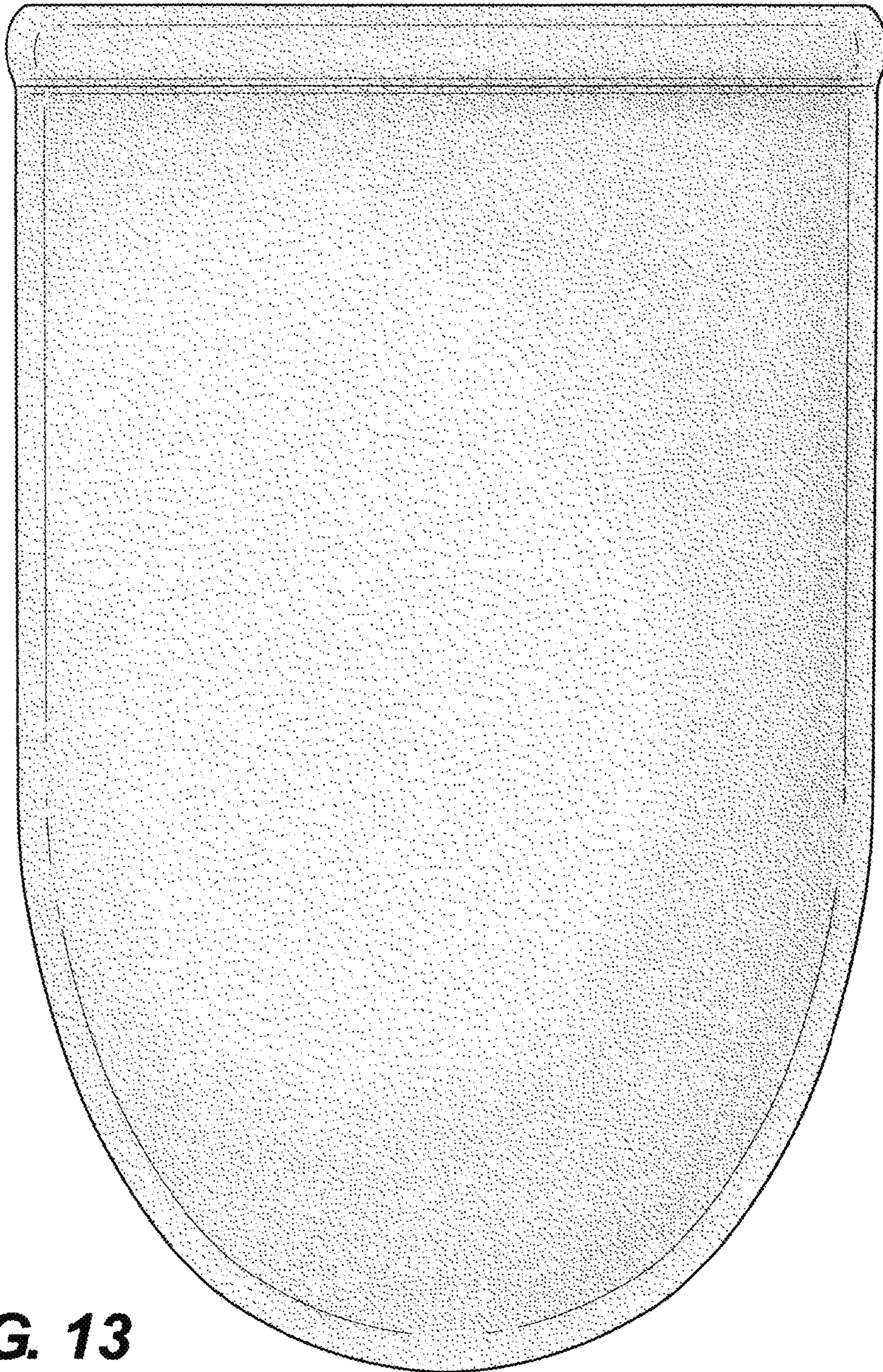

**FIG. 13**

**FIG. 14**

